

GRC[®]

THE ORIGINAL

2018 CATÁLOGO

AMORTIGUADORES
Y STRUTS



www.grcautopartes.com.mx



El primer amortiguador

110+ Años de innovación



Todo comenzó en 1907, cuando **Claude H. Foster inventó el Snubber**, un amortiguador de accionamiento directo para automóviles, único en su tipo. Le siguieron el primer amortiguador hidráulico, el primer amortiguador ajustable y el primer amortiguador de aire ajustable. Hoy seguimos siendo esa empresa americana innovadora e independiente, fabricando amortiguadores y struts de alto rendimiento que cubren el 96% de los vehículos en Norteamérica y con ventas en más de 52 países.

Tenemos el orgullo de fabricar 85% de nuestros productos en Querétaro, México, además nuestra nueva planta en China, garantiza nuestra cobertura en aplicaciones asiáticas con la excelente calidad de GRC®.

Todos los amortiguadores están fabricados para durar. Los nuestros están fabricados para durar más.

Las barras de pistón cromadas evitan la corrosión, lo cual proporciona una óptima superficie de trabajo y extiende la vida del sello de la barra. Así que a diferencia de otros, nosotros cromamos las barras de cada amortiguador y strut que fabricamos, "no solo los Premium". También utilizamos un sello duradero y libre de fugas. Finalmente probamos y validamos rigurosamente todos nuestros productos. Es nuestro deber y es su garantía que cada amortiguador que producimos ofrezca la calidad y rendimiento que espera de la compañía líder en tecnología de amortiguación.



Planta 1 Querétaro



CDD Querétaro



Planta 2 China



Ingeniería de precisión



Pruebas de instalación correcta



Pruebas de manejo

Prueba y Validación

Nosotros validamos cada amortiguador y strut que diseñamos para asegurar su larga duración.

El secreto para fabricar excelentes amortiguadores está en su interior

Calidad y Durabilidad - en cada producto

GRC® ha fabricado amortiguadores desde 1907, cuando inventamos el primer amortiguador automotriz. Al día de hoy, después de perfeccionar la tecnología de amortiguación por más de 100 años, sabemos que el interior es lo que cuenta.

Tubo de trabajo - D.O.M

- El proceso de extrusión en frío (D.O.M.) empleado por GRC®, elimina las uniones e imperfecciones de la superficie
- Este acabado liso reduce la fricción, prolongando la vida útil del producto
- La superficie de los tubos GRC® llega a ser 12 veces más lisa que la de la competencia



Tubo interior con superficie lisa

Barra de pistón con un súper acabado cromado

- La superficie de la barra está cromada y cuenta con súper acabado, lo que ayuda a prevenir la corrosión
- El sello se lubrica con la cantidad adecuada de aceite, prolongando la vida útil del producto
- Las barras de los competidores muestran corrosión, las de GRC® permanecen limpias* *



Barra con un súper acabado cromado

Ensamble de pistón robusto

- El diseño del ensamble de la válvula de pistón de GRC® es extremadamente durable
- El sello de pistón de GRC® se ajusta a medida que se desgasta, para mantener un sello hermético entre el pistón y el tubo de trabajo, esto minimiza las fugas para una vida útil prolongada
- Muchos competidores no utilizan O'ring y su ensamble de válvulas no se ajusta a medida que se desgasta con el tiempo



Diseño de ensamble de válvulas ajustable al desgaste

Limpiador del sello

- El limpiador integrado de GRC®, se ajusta por encima del sello de aceite para evitar que los desechos del camino, la suciedad y el polvo, ingresen al interior del sello y amortiguador
- Los productos de muchos competidores no cuentan con limpiador



Limpiador de residuos tipo E.O.

*En pruebas internas

**Ambas barras se sometieron a la misma prueba estándar ASTM-B117 de 96 horas en cámara salina.

Sin importar el vehículo o camino, tenemos la cobertura

En GRC® creemos que no hay segundos lugares en calidad, rendimiento o cobertura. Por eso ofrecemos amortiguadores, struts y productos especiales de alta calidad para prácticamente cualquier vehículo.



MaxControl® (Series 75000 / 77000)
Amortiguador monotubo premium para un manejo y control avanzado en cualquier camioneta o SUV.

Ultra®

En pocas palabras, Ultra® significa ingeniería de precisión para máxima seguridad y rendimiento con su galardonada tecnología G-Force®.



Amortiguador para camioneta Ultra®
(Series G63000 / G64000)



Guardian® (Series 81000)

Amortiguadores diseñados para recuperar el desempeño del E.O.



Amortiguador Ultra® para autos de pasajeros
(Series 69000 / 70000)



Strut Ultra®
(Series G35000 / G52000 / G55000 / G56000)



ProGuard® (Series 61000)

Diseñados para brindar mayor comodidad y control de las camionetas, furgonetas y SUV's de hoy.



Asiento de resorte Ultra®
(Series G51000)



Cartuchos para Struts Ultra®
(Series G44000)

GRC® ofrece una gama completa de soluciones para control de manejo, incluyendo entre otros, amortiguadores para vehículos de uso comercial e industrial, así como amortiguadores de aire ajustables, estabilizadores de dirección y accesorios. Para conocer más acerca de todos nuestros productos visite www.grcautopartes.com.mx



ReadyMount GRC®

Diseñados, probados y verificados para un máximo rendimiento.

ReadyMount GRC® (Series G57000)

GRC® reconoce que los ensambles de strut son vitales para la seguridad del vehículo. Esta es la razón por la que nunca descansamos para brindarle los strut pre-ensamblados con mayor durabilidad del mercado - nuestro ReadyMount GRC®

Durabilidad Comprada

- 1,000,000 de ciclos para cada nuevo diseño
- Barra de pistón con súper acabado cromado para una resistencia superior contra la corrosión

Estrictas Pruebas de Confiabilidad

- Más de 10 pruebas rigurosas sobre cada nuevo diseño, garantizan el correcto funcionamiento, desgaste adecuado y durabilidad para reducir las devoluciones por garantía.

Gran Expertise de Diseño



Ingeniería de precisión

- Diseñados con alta precisión siguiendo las especificaciones del Equipo Original

Confianza Total



Instalado y Probado en Campo

- Cada diseño de ReadyMount GRC® se instala y prueba en el mismo vehículo para el cual se diseñó para garantizar:
 - Instalaciones más rápidas
 - Menores devoluciones
 - Un ajuste perfecto

Amortiguadores & Productos especiales

PN 77414



Amortiguadores LTV® (Serie 58000)

- El mejor amortiguador para aplicaciones comerciales pesadas.
- Diseñados específicamente para usos pesados en camionetas ligeras y furgonetas.
- Pistón reforzado de 1 5/8" (41mm) y cabeza de compresión de hierro sinterizado.
- Montajes soldados a 360° para máxima resistencia estructural.



Amortiguadores HiJackers® (Serie 49000) Se vende en par

- El amortiguador ajustable de aire más conocido en Norteamérica.
- Ideal para remolcar botes o cargas pesadas.
- Puede ayudar a mejorar el manejo y a reducir el riesgo de que la suspensión pegue con el suelo.
- Hasta 1,100 libras de nivelación por par. **Nota: No debe exceder el peso vehicular bruto. El producto no aumenta la carga útil.**



Kit de Mangueras de Aire (141099)

- Un kit completo y compatible de mangueras para amortiguadores ajustables por aire.
- Fácil de instalar.
- Durable.



Amortiguadores Clásicos GRC® (Serie 82000)

- Tecnología moderna de amortiguación con gas para autos clásicos, de colección y de edición limitada.
- Diseñado específicamente para las necesidades de su vehículo.
- Rendimiento y manejo mejorado.



Protectores de Strut (Serie 143000)

- Protegen la barra y previenen el choque metal con metal.
- El diseño de carreras, bloquea la entrada de tierra y humedad para prolongar la vida del strut.



Amortiguadores de soporte delantero y trasero (Serie 34/43000) Se vende en par

- Combinación perfecta entre la tecnología de amortiguación y resorte.
- Los resortes delanteros de ritmo constante ayudan a mejorar la estabilidad y restaurar o mantener la altura del manejo.
- Los resortes traseros de ritmo variable proporcionan una capacidad de carga de 500 libras, por par. **NOTA: No debe exceder el peso vehicular bruto. El producto no aumenta la carga útil.**



Estabilizadores de Dirección (Serie 6800SE)

- Mejora el manejo y el control de su vehículo amortiguando las cargas laterales del sistema de dirección.
- Bujes de uretano, aceite de alto rendimiento y esponja celular para resistir la pérdida de amortiguación.
- Aumenta la seguridad.



Bases de Strut (Serie 141000/142000/143000)

- Satisfacen o exceden los estándares del Equipo Original.
- Incluyen el kit de accesorios, (si aplica).
- La calidad más alta en aftermarket.



Amortiguadores de Dirección (Serie 14000)

- Reduce la vibración y el desgaste de los neumáticos y otras partes de la suspensión.
- Minimiza el movimiento no deseado en el sistema de dirección para un mejor control.
- Aumenta la seguridad.

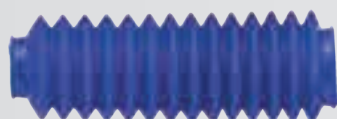

Botas de Estabilizador de Dirección (142001,005,008)

- Prolonga la vida de los estabilizadores de dirección.
- Protege la barra de las partículas del camino.
- Una pequeña inversión para una máxima protección.

Señales de Advertencia

Si nota lo siguiente, son alertas para que revise sus amortiguadores y struts con un profesional hoy mismo.



El auto salta o tiembla



Desgaste desigual en las llantas



Al frenar se inclina hacia adelante



El auto vibra con vientos fuertes



El auto salta después de caer en un bache



Fugas



Superficie rayada o dañada



Declive excesivo o tambaleo en las curvas

Los amortiguadores desgastados afectan la distancia de frenado



80
km/hr

Distancia de frenado con amortiguadores nuevos

3m

Distancia de frenado con amortiguadores desgastados



110
km/hr

Distancia de frenado con amortiguadores nuevos

6m

Distancia de frenado con amortiguadores desgastados



Para mayor información, visite: www.grcautopartes.com.mx

La inspección debe hacerse por profesionales. El reemplazar los amortiguadores o struts con 80mil km de intervalo puede crear un viaje y sensación de manejo más suave y seguro que la mayoría de los autos. Los intervalos de km pueden variar dependiendo del auto, las especificaciones del fabricante, del uso y del medio ambiente.

Causas de devolución que no cubre la garantía

Daños tales como rayaduras o golpes ocasionados en el eje o émbolo del amortiguador causados por uso indebido de herramientas, este abuso provoca funcionamiento anormal y fugas prematuras de aceite.



Golpes o roturas de tubo intermedio o de reserva, que se originan por errores de instalación, interferencia del amortiguador con otra parte del vehículo, o por utilizar la unidad como apoyo o palancas usadas para remover partes de la suspensión o al mismo amortiguador.



Suplementos o adiciones en general. La evidencia de partes soldadas o roscadas que se utilizan para aumentar la longitud del amortiguador, debido a la suspensión del vehículo; lo cual genera golpeteo, rigidez, inestabilidad y otros comportamientos anormales no causados por el amortiguador, que por el contrario impiden su buen funcionamiento.



El desprendimiento o roturas de las fijaciones o terminales del amortiguador. Es causado por errores de instalación al ajustar excesivamente los montajes, por aplicación incorrecta de referencia y en la mayoría de los casos se debe a la modificación de levantar o suplementar la suspensión del vehículo.



Operación o funcionamiento ruidoso causado por el daño, falta de accesorios o montaje indebido de partes que se instalan junto con el amortiguador, como rodamientos, cojinetes de Mac Pherson, soportes, cauchos, arandelas, topes o cubrepolvos que se encuentran en regular o mal estado.



Interferencias, rozamientos o golpeteos constantes con llantas, tubos de escape y chasis; causados por errores de instalación, aplicación incorrecta o modificaciones tales como llantas anchas, suspensiones deportivas, escapes, etc.



Modificación a correderas (anclaje y fijación). Alteraciones como cortes o ampliaciones de los anclajes orientados a corregir fallas en alineación de llantas causadas por daños graves en la suspensión. Estas alteraciones en la estructura del amortiguador ocasionan torceduras, rigidez y daño total del mismo.



Torceduras y dobleces severos. Ocasionados por abusos en el producto, tales como golpes fuertes a la suspensión, chocar con obstáculos grandes como topes o baches profundos.



Garantía

Los amortiguadores, cartuchos y struts



Están garantizados contra cualquier defecto de fabricación, materiales o mal funcionamiento que se presente durante el uso del vehículo operado en condiciones normales.

La garantía cubre la reposición del amortiguador por uno nuevo.
En ningún caso incluye gastos derivados por montaje o instalación.
La garantía no incluye reposición por desgaste normal del uso de su vehículo.

Línea de Gas Ultra con G-Force, Max Control Monotubo y Ready Mount:	Garantía de por vida*
Línea de Gas Guardian y Proguard:	4 años o 300,000 kms.
Línea Hidráulica Guardian y LTV:	2 años o 150,000 kms.
Línea Pesada Hidráulica y Gas:	2 años o 200,000 kms.
Productos Especiales**:	2 años o 100,000 kms.

Notas: En vehículos ligeros para uso comercial, la garantía será limitada por 1 año o 50,000 kms.

*Por el tiempo que el consumidor original sea el dueño del vehículo en el cual fueron originalmente instalados.
Aplican restricciones.

** Amortiguadores de aire y dirección, tope rebote / cubrepolvo y bases para struts.

Aplicación incorrecta

GRC® diseña y fabrica amortiguadores bajo especificaciones de Equipo Original para cada vehículo, cualquier cambio, adaptación o modificación anula la garantía de este producto.

Este catálogo ha sido elaborado con gran cuidado habiéndose verificado la exactitud de los datos contenidos, sin embargo GRC® Autopartes no se hace responsable por posibles datos erróneos o incompletos.

Contenido

Proteja su Auto y la Inversión en Llantas.....	2
Nuevos Números de Parte.....	3
Lista de Reemplazos de 12 años.....	5
Índice por Marca y Modelo.....	7
Índice de Pies de Página.....	17
Códigos de Movimiento.....	19
Nuevo Formato de Catálogo.....	20
Aplicaciones.....	21
Lista Numérica	
Amortiguadores de Dirección.....	326
Amortiguadores de Carga Traseros.....	330
Amortiguadores Guardian Hidráulicos.....	334
Cartuchos Hidráulicos.....	334
Cartuchos de Strut Ultra.....	334
Amortiguadores de Aire Ajustables HiJackers.....	336
Asientos de Resorte Ultra.....	340
Struts Hidráulicos.....	346
Struts Ultra.....	346
ReadyMount Assembly.....	363
Amortiguadores LTV.....	370
Amortiguadores ProGuard.....	375
Amortiguadores para Camioneta Ultra.....	383
Amortiguadores Ultra.....	395
Amortiguadores Guardian Hidráulicos.....	400
Amortiguadores Monotubo MaxControl.....	401
Amortiguadores Guardian.....	407
Bases de Strut.....	420
Protectores de Strut.....	428
Sección de Referencias:	
A.....Kits de Manguera de Aire Ajustable.....	430
Procedimiento para Desactivar el Compresor Electrónico del Sistema de Autonivelación para Modelos GM.....	431
B.....¿Qué es la Base de un Strut?.....	432
C.....Botas para Estabilizadores de Dirección.....	446
D.....Conversión de la Suspensión Electrónica Ajustable.....	447
Tablas de Dimensiones / Intercambios	
E.....Combinaciones Izquierdo / Derecho.....	449
F.....Códigos de Montajes / Longitudes Extendido y Colapsado.....	454
G.....Cómo Deshacerse de Amortiguadores y Struts Viejos o Defectuosos.....	491
H.....Número de Fabricación vs. Número de Catálogo.....	492
I.....Intercambio Entre Líneas GRC.....	510
J.....Intercambio vs. Competidores	
Boge.....	515
Condumex.....	521
KYB.....	527
Monroe.....	538

PROTEJA SU AUTO Y LA INVERSIÓN EN LLANTAS

Beneficios de reemplazar amortiguadores/struts desgastados o sin fuerza

- Frena más rápido (auto más seguro)
- Mayor duración en llantas (reduce gastos de operación)
- Mejora el manejo, funcionamiento y control (aumenta la seguridad del auto)
- Mayor vida en la suspensión (juntas del ensamble, resortes, etc.)
- Un viaje más agradable (menos saltos o tambaleos)

¿Por qué comprar amortiguadores y struts GRC?

- Garantía y servicio
- Carga de gas nitrógeno para un control y desempeño aumentado
- Sello multilabio para mayor durabilidad y vida útil
- Pintura electrostática y autofluorescente para resistir la corrosión
- Válvulas diseñadas por computadora para cada aplicación

Las 3 razones para reemplazar amortiguadores y struts

1. Falla Física

- Fuga de aceite
- Cuerpo abollado o dañado
- Montajes rotos o gastados
- Pistón hundido
- Desgaste irregular de llantas (ahuecado)

2. Funcionamiento

- Al auto le toma más tiempo para detenerse
- El auto se voltea o se inclina en las curvas
- El auto se inclina hacia adelante cuando frena
- El auto rebota después de caer en un bache
- El viaje es duro, rebota o tiembla

3. Preventivo

- Protege las llantas nuevas por más tiempo
- Protege la alineación para un control estable
- Protege el costo de otras partes de la suspensión
- Aumenta el funcionamiento de los frenos

Otros factores en qué pensar:

- Los amortiguadores y struts se deterioran más despacio, para que usted no note el desgaste del control del viaje.
- Los amortiguadores y struts se mueven a un mínimo de 10 millones de veces cada 32 mil kilómetros, trabajando duro para protegerlo a usted y su auto.
- Los amortiguadores y struts desgastados incrementan la cantidad de movimientos de la suspensión del auto durante el viaje. Este movimiento adicional aumenta el uso de otros componentes de la suspensión, lo que puede causar fallas prematuras, que en muchos casos, son más costosos de reemplazar que los amortiguadores y struts.
- Los amortiguadores y struts desgastados permiten que la llanta salte, reduciendo el control del auto.
- Los amortiguadores y struts deteriorados permiten un aumento en el desgaste del diseño de la llanta, reduciendo el funcionamiento y la habilidad para frenar.
- A medida que los amortiguadores y struts se desgastan y pierden resistencia, a su auto le puede tomar más tiempo para frenar. Dependiendo del vehículo y las condiciones del camino, la distancia para frenar varía. Las enfrenadas largas no benefician a nadie.
- Los amortiguadores y struts son los únicos dispositivos en su auto diseñados para reducir las oscilaciones del resorte de la suspensión. Esta reducción en movimiento, ofrece muchos beneficios incluyendo un auto más seguro y confiable.

NUEVOS NÚMEROS DE PARTE

14072	G52066	G52888
70020	G52070	G56892
70028	G52071	G56893
70032	G52073	G64032
70039	G52074	G64071
70068	G52077	G64128
70118	G52078	G64130
70127	G52083	G64131
G244002	G52084	G64154
G511003	G52085	G64181
G511030	G52086	G64182
G511072	G52087	G64184
G51825	G52088	G64185
G51826	G52089	
G51829	G52090	
G51830	G52096	
G51831	G52097	
G51832	G52098	
G51833	G52123	
G51834	G52124	
G51835	G52156	
G51840	G52157	
G51847	G52178	
G51852	G52179	
G51871	G52257	
G51885	G52258	
G51886	G52272	
G51900	G52273	
G51904	G52314	
G51907	G52335	
G51911	G52336	
G51915	G52388	
G51977	G52389	
G52017	G52494	
G52018	G52495	
G52034	G52624	
G52035	G52625	
G52036	G52626	
G52037	G52837	
G52057	G52838	
G52061	G52855	
G52062	G52856	
G52063	G52886	
G52064	G52887	

*NÚMERO DE PARTE FUTURO

NÚMEROS DE PARTE A DESCONTINUAR AL AGOTAR EXISTENCIAS

14020	142233	142412	142650	142857	143228	61507	G44477	G55716
141578	142234	142415	142653	142858	143231	61513	G44773	G55722
141580	142240	142426	142734	142859	143233	61534	G44918	G55723
141974	142241	142427	142735	142860	143235	61545	G44937	G55724
142091	142242	142428	142738	142861	143236	61568	G44943	G55729
142103	142244	142429	142741	142862	143240	61598	G44947	G55730
142108	142245	142430	142744	142880	143262	61681	G44969	G55737
142132	142247	142436	142745	142933	143263	6849SE	G44991	G55738
142133	142248	142437	142746	142936	143264	6862SE	G51007	G55769
142134	142249	142440	142748	142939	143265	6863SE	G51013	G55784
142135	142250	142442	142749	142940	143277	69577	G51027	G55785
142136	142251	142521	142750	142942	143278	69645	G51030	G55796
142141	142292	142524	142751	142943	143279	69773	G51031	G55797
142142	142295	142527	142752	143030	143280	69808	G51064	G55923
142144	142296	142529	142753	143035	143317	69880	G51165	G55924
142145	142298	142530	142754	143036	143320	69884	G51181	G55927
142146	142300	142531	142755	143037	143328	69885	G51182	G55928
142148	142301	142532	142757	143067	143357	69950	G51192	G55931
142150	142302	142543	142762	143071	34076	69951	G51232	G55932
142173	142306	142547	142763	143072	43138	69956	G51290	G56571
142183	142311	142550	142803	143073	43172	69957	G51330	G56579
142189	142316	142556	142825	143074	49157	75755	G52063	G56580
142190	142317	142559	142826	143083	49199	75795	G52064	G56637
142194	142321	142561	142828	143090	49207	77660	G52071	G56713
142195	142325	142562	142832	143112	49214	81542	G52072	G56716
142196	142329	142569	142834	143113	49216	81554	G55509	G56756
142197	142334	142570	142836	143116	49225	81555	G55531	G56757
142217	142335	142571	142840	143139	49381	81557	G55533	G56765
142219	142393	142572	142842	143196	58353	81562	G55534	G56766
142220	142396	142573	142844	143197	58377	81674	G55539	G56767
142221	142399	142626	142846	143199	58387	81739	G55546	G56768
142223	142402	142640	142847	143206	58410	81741	G55580	G56803
142224	142403	142641	142850	143207	58416	81881	G55584	G56804
142225	142404	142642	142851	143208	58456	81907	G55593	G56919
142226	142405	142643	142852	143210	58500	82020	G55594	G63603
142227	142406	142646	142853	143219	58617	82062	G55609	G63868
142228	142408	142647	142854	143220	58625	82124	G55673	
142229	142409	142648	142855	143222	58671	82608	G55704	
142231	142411	142649	142856	143227	61502	82614	G55708	

NÚMEROS DE PARTE REEMPLAZADOS

REEMPLAZADO	AHORA USAR
G51101	G511057
G51743	G511057
G63865	G64087
143299	143354
143300	143355

LISTA DE REEMPLAZOS DE 14 AÑOS

EN CATÁLOGO PASADO	REEMPLAZADO	AHORA USAR	EN CATÁLOGO PASADO	REEMPLAZADO	AHORA USAR	EN CATÁLOGO PASADO	REEMPLAZADO	AHORA USAR
2016	42956	40025	2006	142401	142845	2007-2008	61652	61651
2016	70018	70041	2005	142407	143071 Izq 143072 Der	2004	61661	61575
2016	143299	143354	2006	142423	142858	2007-2008	6827SE	6854SE
2016	143300	143355	2006	142424	142859	2010	69577	69587
2005	141269	143066	2006	142425	142860	2002	69631	69996
2005	141274	143058	2006	142431	142862	2007-2008	69810	69813
2005	141275	143060	2011	142435	143280	2002	69908	69407
2005	141551	143061	2006	142438	142561	2016	69950	70064
2005	141577	143059	2011	142523	143031	2016	69951	70065
2005	141744	143057	2005	142533	143073 Izq 143074 Der	2013	69954	70023
2006	142082	142844	2006	142537	142851	2013	69955	70024
2006	142083	142846	2006	142541	142857	2016	69956	70064
2006	142182	142846	2006	142544	142546	2016	69957	70065
2006	142184	142847	2006	142545	142546	2003	69963	69462
2006	142185	142803	2005	142557	142836	2014	79900	G51887
2006	142188	142832 142854	2006	142558	142559	2015	79901	G51888
2006	142191	142855	2006	142560	142561	2004	801514	801541
2006	142192	142861	2006	142563	142854	2007-2008	801617	801620
2011	142193	143281	2006	142564	142847	2004	81457	82126
2006	142198	142844	2006	142565	142623	2002	81561	61552
2006	142216	142839	2006	142566	142832	2004	81673	81583
2006	142218	142842	2006	142732	142734	2004	81724	82066
2006	142236	142856	2006	142733	142734	2004	81822	81744
2004	142238	142240	2006	142736	142827	2004	81827	81744
2006	142243	142623	2006	142742	143036	2004	81832	81744
2006	142266	142842	2006	142743	143037	2004	82014	81676
2006	142272	142839	2006	142756	142827	2004	82073	82099
2006	142299	143036 L 143037 R	2006	142849	143067	2004	82152	81091
2011	142303	143277	2006	142849	143067	2004	82154	81318
2011	142304	143278	2011	143066	143059	2002	G51018	G51232
2011	142305	143279	2016	143071	143073	2002	G51020	G51229
2006	142314	142840	2016	143072	143074	2002	G51045	G51249
2006	142315	142840	2016	143093	143201	2004	G51079	G51253
2006	142322	142852	2010	143189	142653	2017	G51101	G511057
2006	142324	142853	2004	61514	61593	2016	G51101	G511057
2005	142331	143062	2004	61548	61541	2004	G51257	G51477
2005	142332	143063	2004	61577	61593	2012	G51265	G51796
2005	142333	143064	2004	61581	61506	2016	G51705	69907
2006	142394	142841	2004	61585	61593	2007-2008	G51708	G51254
2006	142395	142841	2004	61587	61552	2017	G51743	G511057
2006	142397	142843	2004	61602	61591	2016	G51743	G511057
2006	142398	142843	2004	61604	61500	2010	G51745	G51746
2006	142400	142845	2004	61628	61623	2012	G51779	G51810
			2004	61636	61642	2012	G51780	G51811
			2004	61644	61614	2016	G52051	G52194

LISTA DE REEMPLAZOS DE 12 AÑOS

EN CATÁLOGO PASADO	REEMPLAZADO	AHORA USAR	EN CATÁLOGO PASADO	REEMPLAZADO	AHORA USAR	EN CATÁLOGO PASADO	REEMPLAZADO	AHORA USAR
2016	G52054	G52193	2006	G56638	G56539			
2015	G52071	G52073	2006	G56639	G56540			
2015	G52072	G52074	2005	G56737	G56719			
2002	G55517	G55616	2005	G56738	G56720			
2005	G55595	G55847	2016	G56752	G52235			
2005	G55596	G55847	2016	G56753	G52236			
			2015	G56754	G52237			
2005	G55597	G55848	2015	G56755	G52338			
			2015	G56756	G52237			
			2015	G56757	G52238			
2005	G55598	G55848	2010	G56783	G56817			
			2011	G56788	G55948			
2004	G55613	G55518	2011	G56789	G55949			
2004	G55614	G55518	2011	G56808	G56809			
2004	G55654	G55830	2011	G56811	G56810			
2004	G55655	G55830	2015	G56815	G52124			
2002	G55659	G55999	2015	G56816	G52123			
2002	G55660	G55999	2007-2008	G56915	G56937			
2002	G55677	G55914	2007-2008	G56922	G56952			
2002	G55678	G55914	2007-2008	G56923	G56954			
2005	G55760	G55742	2012	G56944	G57063			
2004	G55779	G55891	2012	G56944	G57063			
2004	G55791	G55976	2012	G56945	G57064			
2004	G55830	G55780	2012	G56945	G57064			
2002	G55900	G55995	2012	G56946	G57060			
2007-2008	G55995	G55960	2012	G56946	G57060			
2010	G56521	G56522	2004	G63399	G63511			
2012	G56549	G56682	2004	G63412	G63675			
2013	G56549	G56682	2004	G63435	G63506			
2012	G56550	G55810	2004	G63458	G63490			
2013	G56550	G56681	2004	G63497	G63610			
2007-2008	G56564	G51712	2004	G63498	G63612			
		G56750	2004	G63518	G63495			
2007-2008	G56609	G56752	2004	G63519	G63610			
		G56754	2004	G63695	G63615			
		G56751	2004	G63706	G63799			
2007-2008	G56610	G56753	2004	G63774	G63678			
		G56755	2004	G63807	G63622			
		G56750	2004	G63814	G63610			
		G56752	2004	G63861	G63860			
2007-2008	G56613	G56754	2007-2008	G63865	G64087			
		G56756 ver aplicaciones	2016	G63901	G63818			
		G56751	2002	G63930	G63781			
		G56753	2002	G63933	G63782			
2007-2008	G56614	G56755	2002					
		G56757 ver aplicaciones	2002					

ÍNDICE POR MARCA Y MODELO

2	MAZDA	440	DODGE	1100D	INTERNATIONAL
3	MAZDA	500	FIAT	118I	BMW
5	MAZDA	504	PEUGEOT	1200B	INTERNATIONAL
6	MAZDA	505	PEUGEOT	1200C	INTERNATIONAL
80	AUDI	510	NISSAN	1200D	INTERNATIONAL
88	OLDSMOBILE	544	VOLVO	125I	BMW
90	AUDI	600	DODGE	128I	BMW
93	SAAB	604	PEUGEOT	1300B	INTERNATIONAL
95	SAAB	610	NISSAN	1300C	INTERNATIONAL
96	SAAB	620	NISSAN	1300D	INTERNATIONAL
98	OLDSMOBILE	626	MAZDA	130I	BMW
99	SAAB	720	NISSAN	135I	BMW
100	INTERNATIONAL	740	VOLVO	1500 SERIES	GMC
122	VOLVO	745	VOLVO	190D	MERCEDES-BENZ
124	FIAT	760	VOLVO	190E	MERCEDES-BENZ
131	FIAT	780	VOLVO	190SL	MERCEDES-BENZ
142	VOLVO	808	MAZDA	200 QUATTRO	AUDI
144	VOLVO	810	NISSAN	2000 GTX	DODGE
145	VOLVO	850	VOLVO	2000 GTX	EAGLE
150	INTERNATIONAL	880	DODGE	200D	MERCEDES-BENZ
164	VOLVO	900	SAAB	200SX	NISSAN
200	AUDI	924	PORSCHE	220D	MERCEDES-BENZ
200	CHRYSLER	929	MAZDA	230E	MERCEDES-BENZ
200	INTERNATIONAL	940	VOLVO	240D	MERCEDES-BENZ
206	PEUGEOT	944	PORSCHE	240SX	NISSAN
207	PEUGEOT	960	VOLVO	240Z	NISSAN
210	NISSAN	1010	INTERNATIONAL	2500 SERIES	GMC
220	MERCEDES-BENZ	1100	FIAT	250D	MERCEDES-BENZ
230	MERCEDES-BENZ	1110	INTERNATIONAL	260E	MERCEDES-BENZ
240	VOLVO	1200	NISSAN	260Z	NISSAN
242	VOLVO	1210	INTERNATIONAL	280C	MERCEDES-BENZ
244	VOLVO	1310	INTERNATIONAL	280CE	MERCEDES-BENZ
245	VOLVO	1500	FIAT	280E	MERCEDES-BENZ
250	MERCEDES-BENZ	1600	NISSAN	280S	MERCEDES-BENZ
262	VOLVO	1800	VOLVO	280SE	MERCEDES-BENZ
264	VOLVO	1900	OPEL	280SEL	MERCEDES-BENZ
265	VOLVO	2000	NISSAN	280Z	NISSAN
280	MERCEDES-BENZ	4000	AUDI	280ZX	NISSAN
300	CHRYSLER	5000	AUDI	3000GT	MINI
306	PEUGEOT	6000	PONTIAC	300D	MERCEDES-BENZ
307	PEUGEOT	9000	SAAB	300E	MERCEDES-BENZ
310	NISSAN	9-3	SAAB	300M	CHRYSLER
318	BMW	9-5	SAAB	300SD	MERCEDES-BENZ
323	MAZDA	100 QUATTRO	AUDI	300SDL	MERCEDES-BENZ
325	BMW	100 SERIES	AUDI	300SE	MERCEDES-BENZ
330	DODGE	1000 SERIES	GMC	300SEL	MERCEDES-BENZ
400	DODGE	1000B	INTERNATIONAL	300SL	MERCEDES-BENZ
403	PEUGEOT	1000C	INTERNATIONAL	300TD	MERCEDES-BENZ
404	PEUGEOT	1000D	INTERNATIONAL	300ZX	NISSAN
410	NISSAN	1100B	INTERNATIONAL	318I	BMW
411	NISSAN	1100C	INTERNATIONAL	318IS	BMW

ÍNDICE POR MARCA Y MODELO

318TI	BMW	635CSI	BMW	ASPIRE	FORD
320I	BMW	710 PICKUP	NISSAN	ASTRA	CHEVROLET
323CI	BMW	735I	BMW	ASTRA	SATURN
323I	BMW	735IL	BMW	ASTRE	PONTIAC
325CI	BMW	740I	BMW	ASTRO	CHEVROLET
325E	BMW	740IL	BMW	ATLANTIC	VOLKSWAGEN
325I	BMW	750IL	BMW	ATOS	DODGE
325IS	BMW	80 QUATTRO	AUDI	ATTITUDE	DODGE
325IX	BMW	90 QUATTRO	AUDI	AURA	SATURN
328CI	BMW	908B	INTERNATIONAL	AURORA	OLDSMOBILE
328I	BMW	908C	INTERNATIONAL	AVALANCHE 1500	CHEVROLET
330CI	BMW	93B	SAAB	AVALANCHE 2500	CHEVROLET
330I	BMW	9-7X	SAAB	AVALON	TOYOTA
335I	BMW	A100 SERIES	DODGE	AVANTI	STUDEBAKER
350SD	MERCEDES-BENZ	A3	AUDI	AVANZA	TOYOTA
350SDL	MERCEDES-BENZ	A3 QUATTRO	AUDI	AVENGER	DODGE
350SL	MERCEDES-BENZ	A4	AUDI	AVEO	CHEVROLET
350Z	NISSAN	A4 QUATTRO	AUDI	AVIATOR	LINCOLN
370Z	NISSAN	A6	AUDI	AXXESS	NISSAN
380SEC	MERCEDES-BENZ	A6 QUATTRO	AUDI	AZERA	HYUNDAI
380SEL	MERCEDES-BENZ	A8	AUDI	AZTEK	PONTIAC
380SL	MERCEDES-BENZ	ACADIA	GMC	B100	FORD
380SLC	MERCEDES-BENZ	ACADIAN	PONTIAC	B100 VAN	DODGE
380SE	MERCEDES-BENZ	ACCENT	HYUNDAI	B150	FORD
4000 QUATTRO	AUDI	ACCCLAIM	PLYMOUTH	B150 VAN	DODGE
400E	MERCEDES-BENZ	ACCORD	HONDA	B1500 VAN	DODGE
400SS PICKUP	CHEVROLET	ACHIEVA	OLDSMOBILE	B1600	MAZDA
420SEL	MERCEDES-BENZ	ADVENTURER PROSPECTOR	DODGE	B1800	MAZDA
450SE	MERCEDES-BENZ	AERIO	SUZUKI	B200	FORD
450SEL	MERCEDES-BENZ	AEROSTAR	FORD	B200 VAN	DODGE
450SL	MERCEDES-BENZ	ALERO	OLDSMOBILE	B2000	MAZDA
450SLC	MERCEDES-BENZ	ALHAMBRA	SEAT	B210	NISSAN
4RUNNER	TOYOTA	ALLANTE	CADILLAC	B2200	MAZDA
500SEC	MERCEDES-BENZ	ALLIANCE	RENAULT	B2300	MAZDA
500SEL	MERCEDES-BENZ	ALLURE	BUICK	B250 VAN	DODGE
500SL	MERCEDES-BENZ	ALMERA	NISSAN	B2500	MAZDA
521 PICKUP	NISSAN	ALTEA	SEAT	B2500 VAN	DODGE
524TD	BMW	ALTIMA	NISSAN	B2600	MAZDA
525I	BMW	AMANTI	KIA	B300 VAN	DODGE
528E	BMW	AMBASSADOR	AMERICAN MOTORS	B3000	MAZDA
528I	BMW	AMERICAN	AMERICAN MOTORS	B350 VAN	DODGE
530I	BMW	AMIGO	ISUZU	B3500 VAN	DODGE
533I	BMW	AMX	AMERICAN MOTORS	B4000	MAZDA
535I	BMW	APOLLO	BUICK	BAJA	SUBARU
535IS	BMW	APRIO	NISSAN	BARRACUDA	PLYMOUTH
540I	BMW	ARIES	DODGE	BEETLE	VOLKSWAGEN
560SEC	MERCEDES-BENZ	ARMADA	NISSAN	BELAIR	CHEVROLET
560SEL	MERCEDES-BENZ	ARROW	PLYMOUTH	BELVEDERE	PLYMOUTH
60 SPECIAL	CADILLAC	ASCENDER	ISUZU	BERETTA	CHEVROLET
600SL	MERCEDES-BENZ	ASPEN	CHRYSLER	BERMUDA	EDSEL
620 PICKUP	NISSAN	ASPEN	DODGE	BF300	DODGE

ÍNDICE POR MARCA Y MODELO

BF300	DODGE	CABALLERO	GMC	CIVIC DEL SOL	HONDA
BF350	DODGE	CABRIO	VOLKSWAGEN	CJ10	JEEP
BF350	DODGE	CABRIOLET	VOLKSWAGEN	CJ3	JEEP
BISCAYNE	CHEVROLET	CABSTAR	NISSAN	CJ5	JEEP
BLAZER	CHEVROLET	CALAIS	CADILLAC	CJ6	JEEP
BOBCAT	MERCURY	CALAIS	OLDSMOBILE	CJ7	JEEP
BONNEVILLE	PONTIAC	CALIBER	DODGE	CL	ACURA
BORA	VOLKSWAGEN	CAMARO	CHEVROLET	CLASSIC	AMERICAN MOTORS
BOSS TRUCK	CHEVROLET	CAMBRIDGE	PLYMOUTH	CLASSIC	CHEVROLET
BRASILIA	VOLKSWAGEN	CAMRY	TOYOTA	CLIO	RENAULT
BRAT	SUBARU	CANYON	GMC	CLK320	MERCEDES-BENZ
BRAVA	FIAT	CAPRI	MERCURY	CLK350	MERCEDES-BENZ
BRAVADA	OLDSMOBILE	CAPRICE	CHEVROLET	CLK430	MERCEDES-BENZ
BREEZE	PLYMOUTH	CAPTIVA	CHEVROLET	CLK500	MERCEDES-BENZ
BREEZEWAY	MERCURY	CARAVAN	DODGE	CLK550	MERCEDES-BENZ
BRONCO	FORD	CARAVELLE	PLYMOUTH	COBALT	CHEVROLET
BRONCO II	FORD	CARIBE	VOLKSWAGEN	COLONY PARK	MERCURY
BROOKWOOD	CHEVROLET	CARINA	TOYOTA	COLORADO	CHEVROLET
BROUGHAM	CADILLAC	CATALINA	PONTIAC	COLT	DODGE
BROUGHAM	MERCURY	CATERA	CADILLAC	COLT	PLYMOUTH
C10 SUBURBAN	CHEVROLET	CAVALIER	CHEVROLET	COMANCHE	JEEP
C10 TRUCK	CHEVROLET	CAYENNE	PORSCHE	COMBI	VOLKSWAGEN
C1405	CHEVROLET	CB300	DODGE	COMET	MERCURY
C15/C1500 PICKUP	GMC	CB400	DODGE	COMMANDER	JEEP
C15/C1500 SUBURBAN	GMC	CC	VOLKSWAGEN	COMMANDER	STUDEBAKER
C15/G1500 VAN	GMC	CELEBRITY	CHEVROLET	COMMERCIAL CHASSIS	BUICK
C1500 SUBURBAN	CHEVROLET	CELICA	TOYOTA	COMMERCIAL CHASSIS	CADILLAC
C1500 TRUCK	CHEVROLET	CENTURION	BUICK	COMMERCIAL CHASSIS	CHEVROLET
C20 SUBURBAN	CHEVROLET	CENTURY	BUICK	COMMUTER	MERCURY
C20 TRUCK	CHEVROLET	CENTURY	CHEVROLET	COMPASS	JEEP
C2000	CHEVROLET	CHALLENGER	DODGE	CONCORD	AMERICAN MOTORS
C20905	CHEVROLET	CHAMP	PLYMOUTH	CONCORD	PLYMOUTH
C220	MERCEDES-BENZ	CHAMPION	STUDEBAKER	CONCORDE	CHRYSLER
C230	MERCEDES-BENZ	CHARADE	DAIHATSU	CONQUEST	CHRYSLER
C240	MERCEDES-BENZ	CHARGER	DODGE	CONQUEST	DODGE
C25/C2500 PICKUP	GMC	CHEROKEE	JEEP	CONQUEST	PLYMOUTH
C25/C2500 SUBURBAN	GMC	CHEVELLE	CHEVROLET	CONTINENTAL	LINCOLN
C250	MERCEDES-BENZ	CHEVETTE	CHEVROLET	CONTOUR	FORD
C2500 SUBURBAN	CHEVROLET	CHEVY	CHEVROLET	COOPER	MINI
C2500 TRUCK	CHEVROLET	CHEVY II	CHEVROLET	CORDIA	MITSUBISHI
C280	MERCEDES-BENZ	CHEVY PICK UP	CHEVROLET	CORDOBA	CHRYSLER
C30	VOLVO	CHEYENE HUNTER	CHEVROLET	CORDOBA	SEAT
C30 TRUCK	CHEVROLET	CHEYENNE	CHEVROLET	COROLLA	TOYOTA
C300	MERCEDES-BENZ	CHIEFTAIN	PONTIAC	CORONA	TOYOTA
C3000	CHEVROLET	CIMARRON	CADILLAC	CORONET	DODGE
C320	MERCEDES-BENZ	CIRRUS	CHRYSLER	CORRADO	VOLKSWAGEN
C35/C3500 PICKUP	GMC	CITATION	CHEVROLET	CORSA	CHEVROLET
C350	MERCEDES-BENZ	CITATION	EDSEL	CORSAIR	EDSEL
C3500 TRUCK	CHEVROLET	CITATION II	CHEVROLET	CORSAR	VOLKSWAGEN
C3605	CHEVROLET	CITY	HONDA	CORSICA	CHEVROLET
C70	VOLVO	CIVIC	HONDA	CORVAIR	CHEVROLET

ÍNDICE POR MARCA Y MODELO

CORVETTE	CHEVROLET	DART K	DODGE	ELECTRA	BUICK
COUGAR	FORD	DAYTONA	CHRYSLER	ELEMENT	HONDA
COUGAR	MERCURY	DAYTONA	DODGE	ENCLAVE	BUICK
COUNTRY CRUISER	MERCURY	DEL RAY	CHEVROLET	ENTOURAGE	HYUNDAI
COUNTRY SEDAN	FORD	DEL RIO WAGON	FORD	ENVOY	GMC
COUNTRY SQUIRE	FORD	DELMONT 88	OLDSMOBILE	EOS	VOLKSWAGEN
COUPE	AUDI	DELTA 88	OLDSMOBILE	EQUINOX	CHEVROLET
COUPE QUATTRO	AUDI	DELUXE	FORD	ES250	LEXUS
COURIER	FORD	DERBY	VOLKSWAGEN	ES300	LEXUS
CRAFTER	VOLKSWAGEN	DEVILLE	CADILLAC	ES330	LEXUS
CRANBROOK	PLYMOUTH	DIAMANTE	MITSUBISHI	ES350	LEXUS
CRESSIDA	TOYOTA	DIPLOMAT	DODGE	ESCALADE	CADILLAC
CRESTLINE	FORD	DISCOVERY	LAND ROVER	ESCAPE	FORD
CROSSFOX	VOLKSWAGEN	DISPATCHER	JEEP	ESCORT	FORD
CROWN	TOYOTA	DJ5	JEEP	ESTATE WAGON	BUICK
CROWN VICTORIA	FORD	DJ6	JEEP	ESTEEM	SUZUKI
CR-V	HONDA	DL	SUBARU	EUROSPORT	CHEVROLET
CRX	HONDA	DL	VOLVO	EUROVAN	VOLKSWAGEN
CS1073	CHEVROLET	DTS	CADILLAC	EXCEL	HYUNDAI
CS31003	CHEVROLET	DURANGO	DODGE	EXCURSION	FORD
CTS	CADILLAC	DUSTER	PLYMOUTH	EXECUTIVE	PONTIAC
CUBE	NISSAN	DYNAMIC	OLDSMOBILE	EXECUTIVE LIMOUSINE	CHRYSLER
CUSTOM	DODGE	DYNASTY	CHRYSLER	EXECUTIVE SEDAN	CHRYSLER
CUSTOM	FORD	DYNASTY	DODGE	EXP	FORD
CUSTOM	MERCURY	E CLASS	CHRYSLER	EXPEDITION	FORD
CUSTOM	PLYMOUTH	E SERIES MOTORHOME	FORD	EXPLORER	FORD
CUSTOM 300	FORD	E100 VAN	FORD	EXPLORER SPORT TRAC	FORD
CUSTOM 500	FORD	E-150 VAN	FORD	EXPO	MITSUBISHI
CUSTOM CRUISER	OLDSMOBILE	E-200 VAN	FORD	EXPO	PLYMOUTH
CUSTOMLINE	FORD	E-250 SUPER DUTY	FORD	EXPO LRV	MITSUBISHI
CUTLASS	CHEVROLET	E-250 VAN	FORD	EXPRESS 1500	CHEVROLET
CUTLASS	OLDSMOBILE	E300	MERCEDES-BENZ	EXPRESS 2500	CHEVROLET
CUTLASS CALAIS	OLDSMOBILE	E-300 VAN	FORD	EXPRESS 3500	CHEVROLET
CUTLASS CIERA	OLDSMOBILE	E320	MERCEDES-BENZ	F SERIES	FORD
CUTLASS CRUISER	OLDSMOBILE	E-350 SUPER DUTY	FORD	F10	NISSAN
CUTLASS SALON	OLDSMOBILE	E-350 VAN	FORD	F-100	FORD
CUTLASS SUPREME	OLDSMOBILE	E420	MERCEDES-BENZ	F-150	FORD
CX7	MAZDA	E430	MERCEDES-BENZ	F-250	FORD
CX-9	MAZDA	E-450 SUPER DUTY	FORD	F-250 SUPER DUTY	FORD
D100 PICKUP	DODGE	E500	MERCEDES-BENZ	F-350	FORD
D150 PICKUP	DODGE	E-550 SUPER DUTY	FORD	F-350 SUPER DUTY	FORD
D200 PICKUP	DODGE	EAGLE	AMERICAN MOTORS	F-450 SUPER DUTY	FORD
D250 HEAVY DUTY	DODGE	ECHO	TOYOTA	F53	FORD
D250 PICKUP	DODGE	ECLIPSE	MITSUBISHI	F-550 SUPER DUTY	FORD
D300 PICKUP	DODGE	ECONOLINE	FORD	F59	FORD
D350 PICKUP	DODGE	ECOSPORT	FORD	F600	FORD
D50	DODGE	EDGE	FORD	F-700	FORD
DAKOTA	DODGE	EL	ACURA	F85	OLDSMOBILE
DART	CHRYSLER	EL CAMINO	CHEVROLET	FAIRLANE	FORD
DART	DODGE	ELANTRA	HYUNDAI	FAIRMONT	FORD
DART K	CHRYSLER	ELDORADO	CADILLAC		

ÍNDICE POR MARCA Y MODELO

FALCON	FORD	GL	SUBARU	I-280	ISUZU
FASTBACK	VOLKSWAGEN	GLADIATOR	JEEP	I-290	ISUZU
FC150	JEEP	GLC	MAZDA	I30	INFINITI
FC170	JEEP	GLE	VOLVO	I35	INFINITI
FESTIVA	FORD	GOL	VOLKSWAGEN	I-350	ISUZU
FIERO	PONTIAC	GOLDEN HAWK	STUDEBAKER	I-370	ISUZU
FIESTA	FORD	GOLF	VOLKSWAGEN	IBIZA	SEAT
FIESTA	OLDSMOBILE	GRAN FURY	PLYMOUTH	ICHIVAN	NISSAN
FIFTH AVENUE	CHRYSLER	GRAN SPORT	BUICK	II	AVANTI
FIREBIRD	PONTIAC	GRANADA	FORD	I-MARK	ISUZU
FIREBIRD TRANS AM	CHEVROLET	GRAND AM	PONTIAC	IMPALA	CHEVROLET
FIREFLY	PONTIAC	GRAND CARAVAN	DODGE	IMPERIAL	CHRYSLER
FIRENZA	OLDSMOBILE	GRAND CHEROKEE	JEEP	IMPENZA	SUBARU
FIT	HONDA	GRAND LEMANS	PONTIAC	IMPULSE	ISUZU
FIVE HUNDRED	FORD	GRAND MARQUIS	FORD	INTEGRA	ACURA
FJ CRUISER	TOYOTA	GRAND MARQUIS	MERCURY	INTREPID	CHRYSLER
FLEET SPECIAL	PLYMOUTH	GRAND PRIX	PONTIAC	INTREPID	DODGE
FLEETWOOD	CADILLAC	GRAND RAID	PEUGEOT	INTRIGUE	OLDSMOBILE
FOCUS	FORD	GRAND SAFARI	PONTIAC	INVICTA	BUICK
FORD	FORD	GRAND VITARA	SUZUKI	ION	SATURN
FORD 300	FORD	GRAND VOYAGER	CHRYSLER	ION-1	SATURN
FORENZA	SUZUKI	GRAND VOYAGER	PLYMOUTH	ION-2	SATURN
FORESTER	SUBARU	GRAND WAGONEER	JEEP	ION-3	SATURN
FORSA	SUZUKI	GRANDVILLE	PONTIAC	IS300	LEXUS
FOX	AUDI	GREMLIN	AMERICAN MOTORS	J SERIES	JEEP
FOX	VOLKSWAGEN	GS	BUICK	J10	JEEP
FREESTAR	FORD	GS 350	BUICK	J20	JEEP
FREESTYLE	FORD	GS 400	BUICK	J2000	PONTIAC
FREETRACK	SEAT	GS 445	BUICK	J2000 SUNBIRD	PONTIAC
FRONTIER	NISSAN	GS300	LEXUS	J-2500	JEEP
FURY	PLYMOUTH	GS400	LEXUS	JAVELIN	AMERICAN MOTORS
FUSION	FORD	GS430	LEXUS	JEEPSTER	JEEP
FX35	INFINITI	GT	ASUMA	JETFIRE	OLDSMOBILE
FX45	INFINITI	GT750	SAAB	JETSTAR 88	OLDSMOBILE
G1	PONTIAC	GT850	SAAB	JETTA	VOLKSWAGEN
G10 VAN	CHEVROLET	GTI	VOLKSWAGEN	JIMMY	GMC
G1000 SERIES	GMC	GTO	PONTIAC	JOURNEY	DODGE
G2	PONTIAC	GTX	PLYMOUTH	K10 SUBURBAN	CHEVROLET
G20	INFINITI	H-100	DODGE	K10 TRUCK	CHEVROLET
G20 VAN	CHEVROLET	H2	HUMMER	K15/K1500 SUBURBAN	GMC
G25/G2500 VAN	GMC	H3	HUMMER	K15/K1500 TRUCK	GMC
G3	PONTIAC	HAWK	STUDEBAKER	K1500 SUBURBAN	CHEVROLET
G30 VAN	CHEVROLET	HHR	CHEVROLET	K1500 TRUCK	CHEVROLET
G35	INFINITI	HIACE	TOYOTA	K20 SUBURBAN	CHEVROLET
G35/G3500 VAN	GMC	HIGHLANDER	TOYOTA	K20 TRUCK	CHEVROLET
G5	PONTIAC	HILUX	TOYOTA	K25/K2500 SUBURBAN	GMC
G6	PONTIAC	HOMBRE	ISUZU	K25/K2500 TRUCK	GMC
GALANT	MITSUBISHI	HORIZON	PLYMOUTH	K2500 SUBURBAN	CHEVROLET
GALAXIE	FORD	HORMIGA	VOLKSWAGEN	K2500 TRUCK	CHEVROLET
GALAXIE 500	FORD	HORNET	AMERICAN MOTORS	K30 TRUCK	CHEVROLET
GHIA	FORD	I10	HYUNDAI	K3500 TRUCK	CHEVROLET

ÍNDICE POR MARCA Y MODELO

KA	FORD	LW2	SATURN	MERIVA	CHEVROLET
KADETT	OPEL	LW200	SATURN	METEOR	MERCURY
KANGOO	RENAULT	LW300	SATURN	METRO	CHEVROLET
KINGSWOOD	CHEVROLET	LX450	LEXUS	METRO	GEO
L100	SATURN	LX470	LEXUS	MIATA	MAZDA
L200	SATURN	LYNX	MERCURY	MICRA	NISSAN
L300	SATURN	M SERIES VAN	INTERNATIONAL	MICROBUS	CHEVROLET
L300-1	SATURN	M1100	INTERNATIONAL	MICROBUS	DODGE
L300-2	SATURN	M1200	INTERNATIONAL	MICROBUS	GMC
L300-3	SATURN	M1400	INTERNATIONAL	MIGHTY MAX	MITSUBISHI
LACROSSE	BUICK	M3	BMW	MILAN	MERCURY
LANCER	DODGE	M300	DODGE	MILLENIA	MAZDA
LANCER	MITSUBISHI	M350	DODGE	MINI RAM	DODGE
LAND CRUISER	TOYOTA	M5	BMW	MIRADA	DODGE
LANOS	DAEWOO	M800	INTERNATIONAL	MIRAGE	MITSUBISHI
LARK	STUDEBAKER	MAGENTIS	KIA	MKX	LINCOLN
LASER	CHRYSLER	MAGNUM	CHRYSLER	MKZ	LINCOLN
LASER	PLYMOUTH	MAGNUM	DODGE	ML SERIES	MERCEDES-BENZ
LAURENTIAN	PONTIAC	MAGNUM K	CHRYSLER	MODELOS P	CHEVROLET
LEBARON	CHRYSLER	MAGNUM K	DODGE	MONACO	DODGE
LEBARON K	CHRYSLER	MAINLINE	FORD	MONARCH	MERCURY
LEGACY	SUBARU	MALIBU	CHEVROLET	MONDEO	FORD
LEGANZA	DAEWOO	MALIBU TODOS	CHEVROLET	MONTANA	PONTIAC
LEGEND	ACURA	MANTA	OPEL	MONTCLAIR	MERCURY
LEMANS	PONTIAC	MARAUDER	MERCURY	MONTE CARLO	CHEVROLET
LEON	SEAT	MARCH	NISSAN	MONTEGO	MERCURY
LESABRE	BUICK	MARINER	MERCURY	MONTEREY	MERCURY
LHS	CHRYSLER	MARK II	TOYOTA	MONTERO	MITSUBISHI
LIBERTY	JEEP	MARK III	LINCOLN	MONTERO SPORT	MITSUBISHI
LIMITED	BUICK	MARK IV	LINCOLN	MONZA	CHEVROLET
LN7	MERCURY	MARK LT	LINCOLN	MOTORHOME CHASSIS	FORD
LOBO PICK UP	FORD	MARK V	LINCOLN	MOUNTAINEER	MERCURY
LOYALE	SUBARU	MARK VI	LINCOLN	MPV	MAZDA
LS	LINCOLN	MARK VII	LINCOLN	MR2	TOYOTA
LS	SATURN	MARLIN	AMERICAN MOTORS	MULTI	NISSAN
LS1	SATURN	MARQUIS	MERCURY	MURANO	NISSAN
LS2	SATURN	MATADOR	AMERICAN MOTORS	MUSTANG	FORD
LS400	LEXUS	MATIZ	CHEVROLET	MUSTANG II	FORD
LS430	LEXUS	MATIZ G2	PONTIAC	MX-3	MAZDA
LSS	OLDSMOBILE	MATRIX	TOYOTA	MX-5	MAZDA
LTD	FORD	MAVERICK	FORD	MX-6	MAZDA
LTD CROWN VICTORIA	FORD	MAXIMA	NISSAN	MYSTIQUE	MERCURY
LTD II	FORD	MB300	DODGE	NASSAU	CHRYSLER
LUCERNE	BUICK	MB350	DODGE	NAVAJO	MAZDA
LUCINO	NISSAN	MB400	DODGE	NAVIGATOR	LINCOLN
LUMINA	CHEVROLET	MDX	ACURA	NEON	CHRYSLER
LUMINA APV	CHEVROLET	MEADOWBROOK	DODGE	NEON	DODGE
LUMINA VAN	CHEVROLET	MEDALIST	MERCURY	NEON	PLYMOUTH
LUPO	VOLKSWAGEN	MEDALLION	EAGLE	NEW YORKER	CHRYSLER
LUV PICKUP	CHEVROLET	MEGANE	RENAULT	NEWPORT	CHRYSLER
LW1	SATURN	MERCURY	MERCURY	NISSAN SEDAN	NISSAN

ÍNDICE POR MARCA Y MODELO

NITRO	DODGE	PB350	PLYMOUTH	R2500 SUBURBAN	CHEVROLET
NOVA	CHEVROLET	PHANTOM	CHRYSLER	R2500 SUBURBAN	GMC
NUBIRA	DAEWOO	PHOENIX	PONTIAC	R2500 TRUCK	CHEVROLET
NX	NISSAN	PICKUP	CHEVROLET	R2500 TRUCK	GMC
OASIS	ISUZU	PICKUP	GMC	R30 TRUCK	CHEVROLET
ODYSSEY	HONDA	PICKUP	ISUZU	R32	VOLKSWAGEN
OMEGA	OLDSMOBILE	PICKUP	JEEP	R3500 TRUCK	CHEVROLET
OMNI	DODGE	PICKUP	NISSAN	R3500 TRUCK	GMC
ONE-FIFTY SERIES	CHEVROLET	PICKUP	PLYMOUTH	RABBIT	VOLKSWAGEN
OPEL	OPEL	PICKUP	TOYOTA	RABBIT TRUCK	VOLKSWAGEN
OPTIMA	KIA	PILOT	HONDA	RAIDER	DODGE
OPTRA	CHEVROLET	PINTO	FORD	RAIDER	MITSUBISHI
OUTBACK	SUBARU	PLATINA	NISSAN	RAINIER	BUICK
OUTLANDER	MITSUBISHI	PLAZA	PLYMOUTH	RAM 1500 PICKUP	DODGE
OUTLOOK	SATURN	POINTER	VOLKSWAGEN	RAM 1500 VAN	DODGE
P MODELS FORWARD CONTROL	GMC	POINTER PICK UP	VOLKSWAGEN	RAM 2500 PICKUP	DODGE
P10 VAN	CHEVROLET	POLARA	DODGE	RAM 2500 VAN	DODGE
P100	DODGE	POLO	VOLKSWAGEN	RAM 3500 PICKUP	DODGE
P-100	FORD	PONY	HYUNDAI	RAM 3500 VAN	DODGE
P15/P1500 VAN	GMC	POWER HAWK	STUDEBAKER	RAM 50	DODGE
P20 VAN	CHEVROLET	PRECIS	MITSUBISHI	RAM 6500	DODGE
P200	DODGE	PRELUDE	HONDA	RAM 6500	DODGE
P25/P2500 VAN	GMC	PREMIER	EAGLE	RAM WAGON	DODGE
P30 VAN	CHEVROLET	PRESIDENT	STUDEBAKER	RAMBLER	AMERICAN MOTORS
P300	DODGE	PREVIA	TOYOTA	RAMCHARGER	DODGE
P31	CHEVROLET	PRIUS	TOYOTA	RAMPAGE	DODGE
P35/P3500 VAN	GMC	PRIUS C	TOYOTA	RANCH WAGON	FORD
P-350	FORD	PRIZM	CHEVROLET	RANCHERO	FORD
P-400	FORD	PRIZM	GEO	RANGE ROVER	LAND ROVER
PACER	AMERICAN MOTORS	PROBE	FORD	RANGER	EDSEL
PACER	EDSEL	PROTÉGÉ	MAZDA	RANGER	FORD
PACIFICA	CHRYSLER	PROTEGE5	MAZDA	RAV4	TOYOTA
PALIO	FIAT	PS300	CHEVROLET	RD200	DODGE
PALIO ADVENTURE	FIAT	PT CRUISER	CHRYSLER	RDX	ACURA
PARISIENNE	PONTIAC	PULSAR	NISSAN	REATAA	BUICK
PARK AVENUE	BUICK	PULSAR NX	NISSAN	REGAL	BUICK
PARK LANE	MERCURY	PURSUIT	PONTIAC	REGENCY	OLDSMOBILE
PARK LANE WAGON	FORD	PV444	VOLVO	RELAY-2	SATURN
PARTNER	PEUGEOT	Q3	AUDI	RELIANT	PLYMOUTH
PASAT CC	VOLKSWAGEN	Q45	INFINITI	RENDEZVOUS	BUICK
PASEO	TOYOTA	QUANTUM	VOLKSWAGEN	RENO	SUZUKI
PASSAT	VOLKSWAGEN	QUEST	NISSAN	RIDGELINE	HONDA
PASSPORT	HONDA	QX4	INFINITI	RIO	KIA
PATHFINDER	NISSAN	QX56	INFINITI	RIVIERA	BUICK
PATROIT	JEEP	R10 SUBURBAN	CHEVROLET	RL	ACURA
PB100	PLYMOUTH	R10 TRUCK	CHEVROLET	ROADMASTER	BUICK
PB1000 SERIES	GMC	R1500 SUBURBAN	CHEVROLET	ROADRUNNER	PLYMOUTH
PB150	PLYMOUTH	R1500 SUBURBAN	GMC	ROCKY	DAIHATSU
PB200	PLYMOUTH	R1500 TRUCK	GMC	RODEO	ISUZU
PB250	PLYMOUTH	R20 SUBURBAN	CHEVROLET	RODEO SPORT	ISUZU
PB300	PLYMOUTH	R20 TRUCK	CHEVROLET	RONDO	KIA

ÍNDICE POR MARCA Y MODELO

ROUGE	NISSAN	SCENIC	RENAULT	SLX	ACURA
ROUNDUP	EDSEL	SCIROCCO	VOLKSWAGEN	SOLARA	TOYOTA
ROUTAN	VOLKSWAGEN	SCOUPE	HYUNDAI	SOMERSET	BUICK
ROYAL MONACO	DODGE	SCOUT	INTERNATIONAL	SOMERSET REGAL	BUICK
RSX	ACURA	SCOUT II	INTERNATIONAL	SONATA	HYUNDAI
RX-3	MAZDA	SCRAMBLER	JEEP	SONOMA	GMC
RX300	LEXUS	SE	ASUMA	SONORA	CHEVROLET
RX330	LEXUS	SEBRING	CHRYSLER	SORENTO	KIA
RX350	LEXUS	SEDAN	VOLKSWAGEN	SPARK	CHEVROLET
RX-4	MAZDA	SEDONA	KIA	SPECIAL	BUICK
RX400H	LEXUS	SENTRA	NISSAN	SPECTRA	KIA
RX7	MAZDA	SEPHIA	KIA	SPECTRUM	CHEVROLET
S10	CHEVROLET	SEQUOIA	TOYOTA	SPECTRUM	GEO
S15 JIMMY	GMC	SERIES 60 FLEETWOOD	CADILLAC	SPIRIT	AMERICAN MOTORS
S2000	HONDA	SERIES 61	CADILLAC	SPIRIT	DODGE
S320	MERCEDES-BENZ	SERIES 62	CADILLAC	SPIRIT RT	CHRYSLER
S350	MERCEDES-BENZ	SERIES 70 FLEETWOOD	CADILLAC	SPIRIT RT	DODGE
S4	AUDI	SERIES 75 FLEETWOOD	CADILLAC	SPITFIRE	TRIUMPH
S40	VOLVO	SEVILLE	CADILLAC	SPORT WAGON	PLYMOUTH
S420	MERCEDES-BENZ	SHADOW	CHRYSLER	SPORTAGE	KIA
S500	MERCEDES-BENZ	SHADOW	DODGE	SPORTVAN	VOLKSWAGEN
S6	AUDI	SHARAN	VOLKSWAGEN	SPORTWAGON	BUICK
S60	VOLVO	SIDEKICK	SUZUKI	SPRINT	CHEVROLET
S600	MERCEDES-BENZ	SIENNA	TOYOTA	SPRINT	GMC
S70	VOLVO	SIERRA 1500	GMC	SPRINTER	MERCEDES-BENZ
S80	VOLVO	SIERRA 1500 HD	GMC	SPRINTER 2500	DODGE
S90	VOLVO	SIERRA 2500	GMC	SPRINTER 315	MERCEDES-BENZ
SABLE	FORD	SIERRA 2500 HD	GMC	SPRINTER 3500	DODGE
SABLE	MERCURY	SIERRA 3500	GMC	SPRINTER 415	MERCEDES-BENZ
SAFARI	GMC	SIGMA	MITSUBISHI	SPRINTER 515	MERCEDES-BENZ
SAFARI	PONTIAC	SILHOUETTE	OLDSMOBILE	SQUAREBACK	VOLKSWAGEN
SAFARI	VOLKSWAGEN	SILVER HAWK	STUDEBAKER	SSR	CHEVROLET
SAKURA	NISSAN	SILVERADO	CHEVROLET	ST REGIS	CHRYSLER
SAMURAI	NISSAN	SILVERADO 1500	CHEVROLET	ST. REGIS	DODGE
SAMURAI	SUZUKI	SILVERADO 1500 HD	CHEVROLET	STANZA	NISSAN
SANTA FE	HYUNDAI	SILVERADO 2500	CHEVROLET	STAR CHIEF	PONTIAC
SAPPORO	PLYMOUTH	SILVERADO 2500 HD	CHEVROLET	STARFIRE	OLDSMOBILE
SARATOGA	CHRYSLER	SILVERADO 3500	CHEVROLET	STARION	MITSUBISHI
SATELLITE	PLYMOUTH	SILVERADO 3500 HD	CHEVROLET	STARLET	TOYOTA
SAVANA 1500	GMC	SKY HAWK	STUDEBAKER	STARLINER	FORD
SAVANA 2500	GMC	SKYHAWK	BUICK	STATION WAGON	NISSAN
SAVANA 3500	GMC	SKYLARK	BUICK	STEALTH	DODGE
SAVEIRO	VOLKSWAGEN	SKYLINER	FORD	STORM	GEO
SAVOY	PLYMOUTH	SL	SATURN	STRATUS	DODGE
SC	SATURN	SL1	SATURN	STREAMLINER	PONTIAC
SC1	SATURN	SL2	SATURN	STYLELINE DELUXE	CHEVROLET
SC2	SATURN	SL320	MERCEDES-BENZ	STYLELINE SPECIAL	CHEVROLET
SC300	LEXUS	SL500	MERCEDES-BENZ	STYLUS	ISUZU
SC400	LEXUS	SL600	MERCEDES-BENZ	S-TYPE	JAGUAR
SC430	LEXUS	SLK230	MERCEDES-BENZ	SUBURBAN	CHEVROLET
SCAMP	PLYMOUTH	SLK320	MERCEDES-BENZ	SUBURBAN	PLYMOUTH

ÍNDICE POR MARCA Y MODELO

SUBURBAN 1500	CHEVROLET	TOWN CAR	LINCOLN	VALIANT DUSTER	PLYMOUTH
SUBURBAN 2500	CHEVROLET	TOWNSMAN	CHEVROLET	VALIANT SUPER BEE	PLYMOUTH
SUMMIT	EAGLE	TRACER	MERCURY	VAN	MITSUBISHI
SUNBIRD	PONTIAC	TRACKER	CHEVROLET	VAN	TOYOTA
SUNBURST	PONTIAC	TRACKER	GEO	VAN	VOLKSWAGEN
SUNDANCE	PLYMOUTH	TRACKER	GMC	VAN WAGON	TOYOTA
SUNFIRE	ASUMA	TRAFIC	RENAULT	VANAGON	VOLKSWAGEN
SUNFIRE	PONTIAC	TRAILBLAZER	CHEVROLET	VARIANT	VOLKSWAGEN
SUNLINER	FORD	TRAILDUSTER	PLYMOUTH	VECTRA	CHEVROLET
SUNRUNNER	ASUMA	TRANSPORTER	VOLKSWAGEN	VEGA	CHEVROLET
SUNRUNNER	PONTIAC	TRANS SPORT	PONTIAC	VEHICROSS	ISUZU
SUPER	BUICK	TRANSIT	FORD	VENTURA	PONTIAC
SUPER BEETLE	VOLKSWAGEN	TRAVELALL	INTERNATIONAL	VENTURE	CHEVROLET
SUPER CHIEF	PONTIAC	TRAVERSE	CHEVROLET	VENZA	TOYOTA
SUPER DELUXE	FORD	TRAX	CHEVROLET	VERACUZ	HYUNDAI
SUPERBIRD	PLYMOUTH	TREDIA	MITSUBISHI	VERNA	DODGE
SUPRA	TOYOTA	TRIBUTE	MAZDA	VERSA	NISSAN
SW1	SATURN	TROOPER	ISUZU	VERSAILLES	LINCOLN
SW3	SATURN	TRUCK	DODGE	VIBE	PONTIAC
SWIFT	SUZUKI	TSUBAME	NISSAN	VICTORIA	FORD
SYCLONE	GMC	TSURU	NISSAN	VIGOR	ACURA
T100	TOYOTA	TSX	ACURA	VILLAGER	EDSEL
T1000	PONTIAC	TT	AUDI	VILLAGER	MERCURY
TACOMA	TOYOTA	TT QUATTRO	AUDI	VIP	PLYMOUTH
TAHOE	CHEVROLET	TUCSON	HYUNDAI	VISION	EAGLE
TALON	EAGLE	TUNDRA	TOYOTA	VISTA	EAGLE
TAURUS	FORD	TURISMO	PLYMOUTH	VISTA CRUISER	OLDSMOBILE
TAURUS X	FORD	TURNPIKE CRUISER	MERCURY	VITARA	SUZUKI
TC	SCION	TWO-TEN SERIES	CHEVROLET	VOLARE	CHRYSLER
TEMPEST	PONTIAC	TYPHOON	GMC	VOLARE	PLYMOUTH
TEMPO	FORD	UNIVERSAL	JEEP	VOLARE K	PLYMOUTH
TERCEL	TOYOTA	UPLANDER	CHEVROLET	VOYAGER	CHRYSLER
TERRAIN	GMC	URVAN	NISSAN	VOYAGER	MERCURY
TERRAZA	BUICK	V10 TRUCK	CHEVROLET	VOYAGER	PLYMOUTH
THING	VOLKSWAGEN	V1500 SUBURBAN	GMC	VUE	SATURN
THUNDERBIRD	FORD	V1500 TRUCK	GMC	W100 PICKUP	DODGE
TIBURON	HYUNDAI	V20 SUBURBAN	CHEVROLET	W150 PICKUP	DODGE
TIGRA	CHEVROLET	V20 TRUCK	CHEVROLET	W200 PICKUP	DODGE
TIGUAN	VOLKSWAGEN	V2500 SUBURBAN	CHEVROLET	W250 PICKUP	DODGE
TIIDA	NISSAN	V2500 SUBURBAN	GMC	W300 PICKUP	DODGE
TITAN	NISSAN	V2500 TRUCK	GMC	W350 PICKUP	DODGE
TL	ACURA	V30 TRUCK	CHEVROLET	WAGONEER	JEEP
TOLEDO	SEAT	V3500 TRUCK	CHEVROLET	WAVE	PONTIAC
TOPAZ	FORD	V3500 TRUCK	GMC	WILDCAT	BUICK
TOPAZ	MERCURY	V40	VOLVO	WINDSOR	CHRYSLER
TORINO	FORD	V50	VOLVO	WINDSTAR	FORD
TORNADO	CHEVROLET	V70	VOLVO	WRANGLER	JEEP
TORONADO	OLDSMOBILE	V8 QUATTRO	AUDI	X3	BMW
TORRENT	PONTIAC	V90	VOLVO	X5	BMW
TOUAREG	VOLKSWAGEN	VAGONETA	FORD	X-90	SUZUKI
TOWN & COUNTRY	CHRYSLER	VALIANT	PLYMOUTH	XA	SCION
				XB	SCION

ÍNDICE POR MARCA Y MODELO

XC90	VOLVO
XG300	HYUNDAI
XG350	HYUNDAI
XJ12	JAGUAR
XJ6	JAGUAR
XJS	JAGUAR
XK150	JAGUAR
XKE	JAGUAR
XL-7	SUZUKI
XT	SUBARU
XTERRA	NISSAN
X-TRAIL	NISSAN
YARIS	TOYOTA
YUKON	GMC
Z3	BMW
ZAFIRA	CHEVROLET
ZEPHYR	LINCOLN
ZEPHYR	MERCURY

ÍNDICE DE PIES DE PÁGINA

- 1 Número de parte futuro, disponible el 1er trimestre de 2018.
- 2 Número de parte futuro, disponible el 2er trimestre de 2018.
- 3 Número de parte futuro, disponible el 3er trimestre del 2018.
- 4 Número de futuro, las cantidades disponibles Q4 2015
- 5 Use el kit 140719 para reemplazar partes del EO de montaje inferior cuando los pernos se rompan o los tornillos autoroscantes no se puedan utilizar más.
- 6 Se recomienda que cuando se reemplacen amortiguadores “quad”, los 4 sean de la misma serie.
- 7 Paquetes en pares kit de mangueras de aire incluido
- 8 Paquetes en pares
- 9 Vea Ref.D para los procedimientos de reemplazo de una Susp. Elect. Ajust. con un producto no ajust.
- 10 Los amortiguadores NIVOMAT son para aplicación trasera únicamente.
Si los resortes tocan los amortiguadores, gírelos 180°.
- 30 Para Vehículos GM equipados con sistemas de nivelación de fábrica, vea Ref. A.
- 31 Con Susp. NIVOMAT, reemplace el resorte con No. de OE. Volvo 1229052/4.
- 32 Con Susp. NIVOMAT, reemplace el resorte con el No. Volvo 1359710 o 1273977.
- 34 Si el resorte toca el amortiguador, gire el resorte 180°.
- 35 Es necesaria abertura en brazo de control para instalar el producto fabricado antes de agosto 1988.
- 36 Requiere una herramienta especial de instalación para struts.
- 37 Amortiguador con Asiento de Resorte sin carga de gas.
- 39 El strut de aire ajustable de EO puede reemplazarse con un strut convencional.
Sin embargo, el sistema de autonivelación debe desactivarse. Vea Ref. A.
- 40 Strut ReadyMount. Ensamble Completo
- 41 Strut ReadyMount. Ensamble Completo. Consulte la Ref. D para el procedimiento de reemplazo en una Susp. Elec. Ajustable con un producto no ajustable
- 42 Strut ReadyMount, no incluye resortes por el diseño del vehículo.
- 43 Strut ReadyMount, no incluye resortes por el diseño del vehículo. Consulte la Ref. D para el procedimiento de reemplazo en una Susp. Elec. Ajustable con un producto no ajustable
- 44 Este strut no está presurizado por lo que el vástago no se extenderá por sí solo.
- 50 Para proteger la barra del pistón, se recomienda utilizar el kit Bellows No.141242.
- 51 Protectores de Strut.
- 53 Montaje de Strut. Es probable reutilizar algunas partes del E.O.
- 54 Kit con Montaje y Rodamiento. Es probable que reutilizar algunas partes del E.O.
- 55 El Kit de Montaje incluye: Montaje, Asiento de Resorte, Rodamiento y Aislador.
Es probable reutilizar algunas partes del E.O.
- 56 El Kit de Montaje incluye: Montaje, Parachoques y Retenedores. Es probable reutilizar algunas partes del E.O.
- 57 El Kit de Montaje incluye: Asiento de Resorte Inferior con Rodamiento Interno y Aislador.
Es probable reutilizar algunas partes del E.O.
- 58 El Kit de Montaje incluye: Rodamiento de Suspensión. Es probable reutilizar algunas partes del E.O.
- 59 La Base de Strut contiene un Rodamiento de Plástico. Es probable reutilizar algunas partes del E.O.
- 60 La Base de Strut contiene un Rodamiento de Metal. Es probable reutilizar algunas partes del E.O.
- 61 El Kit de Montaje incluye: Asiento de Resorte Superior. Es probable reutilizar partes del E.O.
- 62 Kit de Montaje incluye Buje de Montaje Inferior. Es probable reutilizar algunas partes del E.O.
- 63 El Kit de Montaje incluye: Aislador Parachoques. Es probable reutilizar algunas partes del E.O.

ÍNDICE DE PIES DE PÁGINA

- 64 El Kit de Montaje incluye: Aislador de Goma del Asiento de Resorte.
Es probable reutilizar algunas partes del E.O.
- 65 El Kit de Montaje incluye: Asiento de Resorte Superior con Aislador.
Es probable reutilizar algunas partes del E.O.
- 66 Asiento de Resorte Superior con Espaciador. Es probable reutilizar algunas partes del E.O.
- 68 Kit de Accesorios de Montaje. Aislador de Goma del Asiento de Resorte.
Es probable reutilizar algunas partes del E.O.
- 70 Kit Buje y Camisa. Algunos accesorios del Equipo Original podrían ser necesarios
- 80 No requiere soportes para el montaje, instalar sobre montajes de EO Vea Ref. C para Botas.
- 82 Use kit si está señalado. Vea Ref. C para Botas.
- 84 Amortiguador de repuesto para los vehículos con el kit de montaje aftermarket GRC
- 98 Nota: El nivel de dificultad para instalar este producto es moderadamente alto.
Por favor revise las instrucciones cuidadosamente antes de comenzar.

CÓDIGOS DE MOVIMIENTO

- A** RÁPIDO
- B** BUENO
- C** RAZONABLE
- D** LENTO

- FF** NÚMERO DE PARTE NUEVO, DISPONIBILIDAD SERÁ ANUNCIADA
- N** NÚMERO DE PARTE NUEVO
- S** NÚMERO DE PARTE REEMPLAZADO - HASTA AGOTAR EXISTENCIAS

- W** EXTREMADAMENTE LENTO

- X** NÚMERO DE PARTE A DECONTINUAR CUANDO EL INVENTARIO ACTUAL SE TERMINE - EN EL CATÁLOGO DEL AÑO PASADO

NUEVO FORMATO DE CATÁLOGO

El catálogo GRC para vehículos ligeros presenta un nuevo formato. La sección de aplicaciones despliega la información en Delanteros y Traseros en cada una de nuestras líneas de producto. Si tiene alguna pregunta, por favor contacte al Experto al 01 800 1227 846.

DESCRIPCIONES CLAVE EN EL CATÁLOGO



$\frac{O}{O}$ Anillo
Anillo



$\frac{O}{\ominus}$ Anillo
Corbata



$\frac{O}{\vdash}$ Anillo
Espiga



$\frac{\vdash}{\vdash}$ Espiga
Espiga



$\frac{\vdash}{\ominus}$ Espiga
Corbata



$\frac{\vdash}{O}$ Espiga
Anillo



$\frac{\ominus}{\ominus}$ Corbata
Corbata



$\frac{\ominus}{\vdash}$ Corbata
Espiga



$\frac{\ominus}{O}$ Corbata
Anillo



$\frac{O}{\cap}$ Anillo
Horquilla



$\frac{\ominus}{\cap}$ Corbata
Horquilla



$\frac{\vdash}{\cap}$ Espiga
Horquilla

Las imágenes son solamente referenciales.

AMORTIGUADORES Y STRUTS

Año	Notas de Aplicación	Front					Rear				
		Ultra	ProGuard\ Guardian	LTV\ Max Control	Protector de Strut\ Bases de Strut	HiJacker\ Soporte\ Hidráulico	Ultra	ProGuard\ Guardian	LTV\ Max Control	Protector de Strut\ Bases de Strut	HiJacker\ Soporte\ Hidráulico

ACURA

ACURA

CL

01-03	Todos	G55870	142230 ⁵³	G55871	142231 ⁵³
97-99	Todos	G55877	142230 ⁵³	G55786	142231 ⁵³

EL

01-03	Izquierdo	G56621	G51700	142230 ⁵³
	Derecho	G56622	G51700	142230 ⁵³
97-00	Todos	G55909	142230 ⁵³	G55910	142230 ⁵³

EL READYMOUNTS

		Delantero		Trasero	
01-03	Izquierdo	G57028 ⁴⁰		
	Derecho	G57029 ⁴⁰		

INTEGRA

97-01	GS, GS-R, LS, Upper Mount orientation may be required	G55802	142230 ⁵³
94-01	Todos	142230 ⁵³
	Exc. Modelos RS y Type R	G55802	142230 ⁵³	G55803
95-96	GS-R, LS, Special Edition, Upper Mount orientation may be required	G55802	142230 ⁵³
94	GS-R, LS, Upper Mount orientation may be required	G55802	142230 ⁵³
90-93	Todos	G55787	142230 ⁵³	G55788	142230 ⁵³ 142300 ⁶²
86-89	Todos	G55731	G51034	142231 ⁵³

INTEGRA READYMOUNTS

		Delantero		Trasero	
94-01	Exc. Modelos RS y Type R Izquierdo	G56993 ⁴⁰		G56995 ⁴⁰	
	Exc. Modelos RS y Type R Derecho	G56994 ⁴⁰		G56995 ⁴⁰	

LEGEND

91-95	Izquierdo	G55958	G55952
	Derecho	G55951	G55952
89-90	Exc. Sistema de Autonivelación	G55770	142230 ⁵³	142231 ⁵³
87-88	Coupe	G55770	142230 ⁵³	142231 ⁵³
86-88	Todos	142230 ⁵³

MDX

12-13	Izquierdo Exc. Suspensión Activa	G52249
	Derecho Exc. Suspensión Activa	G52250
07-11	Izquierdo Exc. Suspensión Activa	G52249	G64080
	Derecho Exc. Suspensión Activa	G52250	G64080

40 Strut ReadyMount. Ensemble Completo

53 Montaje de Strut. Es probable reutilizar algunas partes del E.O.

62 Kit de Montaje incluye Buje de Montaje Inferior. Es probable reutilizar algunas partes del E.O.

Texto en Negritas - Número de Parte Nuevo / Futuro

AMORTIGUADORES Y STRUTS

Año	Notas de Aplicación	Front					Rear				
		Ultra	ProGuard\ Guardian	LTV\ Max Control	Protector de Strut\ Bases de Strut	HiJacker\ Soporte\ Hidráulico	Ultra	ProGuard\ Guardian	LTV\ Max Control	Protector de Strut\ Bases de Strut	HiJacker\ Soporte\ Hidráulico

ACURA

ACURA

MDX (cont)

03-06	Izquierdo	G52140	143315 ⁵³	...	G64003	61704
	Derecho	G52141	143315 ⁵³	...	G64003	61704
01-02	Izquierdo	G56759	143315 ⁵³	...	G64003	61704
	Derecho	G56758	143315 ⁵³	...	G64003	61704

MDX READYMOUNTS

		Delantero	Trasero
01-02	Izquierdo	G57119 ⁴⁰	...
	Derecho	G57120 ⁴⁰	...

RDX

07-12	Izquierdo	G52187	G51966
	Derecho	G52188	G51966

RL

05-11	Izquierdo	G51911	G51912
	Derecho	G51911	G51913
96-04	Izquierdo	G52057	G51829
	Derecho	G52058	G51829

RSX

05-06	Izquierdo	G52346	G51914	142230 ⁵³	...
	Derecho	G52347	G51914	142230 ⁵³	...
	Modelos Base y Type-S Izquierdo	143233 ⁶⁰
	Modelos Base y Type-S Derecho	143265 ⁶⁰
02-06	Modelos Base y Type-S	143353 ⁵³
02-04	Izquierdo	G56794	G51830	142230 ⁵³	...
	Derecho	G56793	G51830	142230 ⁵³	...

SLX

96-99	Todos	G63707	61607	G63708	61608 81909
-------	-------	--------	-------	-----	-----	-----	--------	----------------	-----	-----	-----

TL

09-14	Izquierdo	G51917	142230 ⁵³	...	G51919	142230 ⁵³	...
	Derecho	G51918	142230 ⁵³	...	G51919	142230 ⁵³	...
04-08	Todos	G51737	142230 ⁵³	...	G51738	142230 ⁵³	...
99-03	Todos	G55870	142230 ⁵³	...	G55871	142230 ⁵³	...

40 Strut ReadyMount. Ensamble Completo

53 Montaje de Strut. Es probable reutilizar algunas partes del E.O.

60 La Base de Strut contiene un Rodamiento de Metal. Es probable reutilizar algunas partes del E.O.

Texto en Negritas - Número de Parte Nuevo / Futuro

AMORTIGUADORES Y STRUTS

Año	Notas de Aplicación	Front					Rear				
		Ultra	ProGuard\ Guardian	LTV\ Max Control	Protector de Strut\ Bases de Strut	HiJacker\ Soporte\ Hidráulico	Ultra	ProGuard\ Guardian	LTV\ Max Control	Protector de Strut\ Bases de Strut	HiJacker\ Soporte\ Hidráulico

ACURA

ACURA

TL (cont)

95-98	Todos		142230 ⁵³
-------	-------	--	------	------	------	----------------------	------	--	------	------	------	------	------

TL READYMOUNTS

04-08	Todos							Delantero	Trasero				
								G57056				

TSX

09-14	Todos			G51919
04-08	Todos		G51737		G51847

VIGOR

92-94	Todos		142230 ⁵³	142231 ⁵³
-------	-------	--	------	------	------	----------------------	------	--	------	------	------	----------------------	------

AMERICAN MOTORS

AMERICAN MOTORS

AMBASSADOR

70-74	Todos	I	82126	81340
67-69	Todos	I	82155
60-66	Todos	I	82066

AMERICAN

64-68	Todos	I	82069	82155
59-62	Todos	I	82155

AMX

78-80	Todos	I	82126	82125
75	Todos	I	81340
70-74	Todos	I	82126	81340
68-69	Todos	I	82069	82155

CLASSIC

61-66	Todos	I	82066
-------	-------	---	------	------	------	------	------	--	------	-------	------	------	------

CONCORD

78-83	Todos	I	82126	82125
-------	-------	---	------	-------	------	------	------	--	------	-------	------	------	------

EAGLE

80-88	Todos	I	81491	81340
-------	-------	---	------	-------	------	------	------	--	------	-------	------	------	------

EAGLE ESTABILIZADORES DE DIRECCIÓN

80-88	Todos							Delantero	Trasero				
								6804SE ⁸⁰				

GREMLIN

71-78	Todos	I	82126	82125
70	Todos	I	82126	82051

HORNET

71-77	Todos	I	82126	82125
70	Todos	I	82126	82051

JAVELIN

70-74	Todos	I	82126	81340
-------	-------	---	------	-------	------	------	------	--	------	-------	------	------	------

53 Montaje de Strut. Es probable reutilizar algunas partes del E.O.

80 No requiere soportes para el montaje, instalar sobre montajes de EO Vea Ref. C para Botas.

AMORTIGUADORES Y STRUTS

Año	Notas de Aplicación	From					Rear				
		Ultra	ProGuard\ Guardian	LTV\ Max Control	Protector de Strut\ Bases de Strut	HiJacker\ Soporte\ Hidráulico	Ultra	ProGuard\ Guardian	LTV\ Max Control	Protector de Strut\ Bases de Strut	HiJacker\ Soporte\ Hidráulico

AMERICAN MOTORS JAVELIN (cont)

68-69	Todos	82069	82155
-------	-------	-------	-------	-------	-------	-------	-------	-------	-------	-------	-------

AMERICAN MOTORS

MARLIN

67	Todos	82155
65-66	Todos	82066

MATADOR

71-78	Todos	82126	81340
-------	-------	-------	-------	-------	-------	-------	-------	-------	-------	-------	-------

PACER

75-80	Todos	82025	81270	49105 ⁷
-------	-------	-------	-------	-------	-------	-------	-------	-------	-------	-------	--------------------

RAMBLER

69	Todos	82069	82155
59-60	Todos	82155

SPIRIT

79-83	Todos	82126	82125
-------	-------	-------	-------	-------	-------	-------	-------	-------	-------	-------	-------

ASUNA

ASUNA

GT, SE+C487

93	Todos	G44903	69749	81530	141974 ⁵³	49371 ⁷
----	-------	--------	-------	-------	-------	-------	-------	-------	-------	-------	----------------------	--------------------

SE

93	Todos	G44903	69749	81530	141974 ⁵³	49371 ⁷
----	-------	--------	-------	-------	-------	-------	-------	-------	-------	-------	----------------------	--------------------

SUNFIRE

93	Todos	G55780	142317 ⁵³
	Exc. Suspensión Lotus	G55780	142317 ⁵³	G55776

SUNRUNNER

92-93	Todos	142294 ⁵⁴	G63799	61560 81904	49613 ⁷
	Sin ABS	G56518	142294 ⁵⁴	G63799	61560 81904	49613 ⁷

AUDI

AUDI

80

88-92	Todos	G44902 ⁹⁸	142195 ⁵³	G51013
-------	-------	----------------------	-------	-------	----------------------	-------	-------	--------	-------	-------	-------	-------

80 QUATTRO

88-92	Todos	G44902 ⁹⁸	142195 ⁵³
-------	-------	----------------------	-------	-------	----------------------	-------	-------	-------	-------	-------	-------	-------

90

96-97	Todos	G44902
93-95	Todos	G44902 ⁹⁸	142195 ⁵³	G51013
88-91	Todos	G44902 ⁹⁸	142195 ⁵³	G51013





7 Paquetes en pares; kit de mangueras de aire incluido

54 Kit con Montaje y Rodamiento. Es probable que reutilizar algunas partes del E.O.

53 Montaje de Strut. Es probable reutilizar algunas partes del E.O.

98 Nota: El nivel de dificultad para instalar este producto es moderadamente alto. Por favor revise las instrucciones cuidadosamente antes de comenzar.



AMORTIGUADORES Y STRUTS

Año	Notas de Aplicación										
			Ultra	ProGuard\ Guardian	LTV\ Max Control	Protector de Strut\ Bases de Strut	HiJacker\ Soporte\ Hidráulico		Ultra	ProGuard\ Guardian	LTV\ Max Control

AUDI

AUDI

90 QUATTRO

93-95	Todos		G44902 ^{5B}	142195 ⁵³
88-91	Todos		G44902 ^{5B}	142195 ⁵³

100

89-94	Fab. a finales del 91		G44450 ^{9B}
-------	-----------------------	---	----------------------	------	------	------	------	------	------	------	------	------

100 QUATTRO

89-94	Todos		G44450 ^{9B}
-------	-------	---	----------------------	------	------	------	------	------	------	------	------	------



200

89-90	Todos		G44450 ^{9B}
-------	-------	---	----------------------	------	------	------	------	------	------	------	------	------

200 QUATTRO

89-90	Wagon		G44450 ^{9B}
-------	-------	---	----------------------	------	------	------	------	------	------	------	------	------

4000

80-87	Todos		G44902 ^{5B}	142195 ⁵³		G51013
-------	-------	---	----------------------	------	------	----------------------	------	---	--------	------	------	------	------

4000 QUATTRO

84-87	Todos		G44902 ^{5B}	142195 ⁵³
-------	-------	---	----------------------	------	------	----------------------	------	------	------	------	------	------









5000

78-88	Todos		G44450 ^{9B}
-------	-------	---	----------------------	------	------	------	------	------	------	------	------	------

A1

11-13	Exc. S Line		G52585
-------	-------------	---	--------	------	------	------	------	------	------	------	------	------



A3

04-12	Todos		143344 ⁵³	143345 ⁵³	
	Exc. S3 y suspensión electrónica		143344 ⁵³		G51799	
	Exc. S3 y suspensión electrónica, con cilindro exterior de 50 mm		G52311	143344 ⁵³	
	Exc. S3 y suspensión electrónica, con cilindro exterior de 55 mm		G56899	143344 ⁵³	
98-03	Todos			G69945
96-97	Todos		G56606	

53 Montaje de Strut. Es probable reutilizar algunas partes del E.O.

98 Nota: El nivel de dificultad para instalar este producto es moderadamente alto. Por favor revise las instrucciones cuidadosamente antes de comenzar.



AMORTIGUADORES Y STRUTS

Año	Notas de Aplicación										
		Ultra	ProGuard\ Guardian	LTV\ Max Control	Protector de Strut\ Bases de Strut	HiJacker\ Soporte\ Hidráulico	Ultra	ProGuard\ Guardian	LTV\ Max Control	Protector de Strut\ Bases de Strut	HiJacker\ Soporte\ Hidráulico



AUDI

AUDI

















A3 (cont)

96-97	1.6, 1.8 L	 G56606	 69945
-------	------------	--	------	------	------	------	---	------	------	------	------











A3 QUATTRO

96-99	Todos	 G56606	 69945
-------	-------	--	------	------	------	------	---	------	------	------	------











A4

09-12	Suspensión Deportiva	 G52626	 G511076
	Exc. Suspensión Deportiva RR	 G511072
01-08	Todos	 G51740	142652 ⁵⁴	 69586
00	Todos	 G51740	142652 ⁵⁴	 G51100
98-99	Avant, Suspensión Deportiva	 G51099	142652 ⁵⁴	 G51100
97-99	Exc. Suspensión Deportiva	 G51097	142652 ⁵⁴	 G51100
96-99	Todos		142652 ⁵⁴	 G51100
96-97	Suspensión Deportiva	 G51099	142652 ⁵⁴	 G51100
96	Base, Exc. Suspensión Deportiva	 G51097	142652 ⁵⁴	 G51100

A4 QUATTRO



09-12	Suspensión Deportiva	 G52626	 G511076
	Exc. Suspensión Deportiva RR	 G511072
02-08	Todos		 69586
	Fab. desde 11/00; Exc. Suspensión Deportiva	 G51740	 69586
00-01	Fab. desde 11/00; Exc. Suspensión Deportiva	 G51740
98-00	Avant, Suspensión Deportiva	 G51099
96-00	Base, Fab. hasta 11/00 Exc. Suspensión Deportiva	 G51097
96-97	Suspensión Deportiva	 G51099

A6

09-11	Exc. Suspensión deportiva y neumática		 G51968
06-08	Exc. Suspensión deportiva y neumática	 G51915	 G51968
98-04	Todos		142652 ⁵⁴	 69946
	Exc. Suspensión Deportiva	 G511057	142652 ⁵⁴	 69946
99-00	Avant, Suspensión Deportiva	 G51099	142652 ⁵⁴	 69946

54 Kit con Montaje y Rodamiento. Es probable que reutilizar algunas partes del E.O.



AMORTIGUADORES Y STRUTS

Año	Notas de Aplicación	Front					Rear				
			ProGuard\ Guardian	LTV\ Max Control	Protector de Strut\ Bases de Strut	HiJacker\ Soporte\ Hidráulico		ProGuard\ Guardian	LTV\ Max Control	Protector de Strut\ Bases de Strut	HiJacker\ Soporte\ Hidráulico













AUDI

AUDI

A6 (cont)

98	Suspensión Deportiva		G51099	142652 ⁵⁴		69946
----	----------------------	---	--------	------	------	----------------------	------	---	-------	------	------	------	------

A6 QUATTRO

09-11	Exc. Suspensión deportiva y neumática			G51968
08	Exc. Suspensión deportiva y neumática		G51915		G51968
05-07	Todos		142652 ⁵⁴	
	Exc. Suspensión deportiva y neumática		G51915	142652 ⁵⁴		G51968
98-04	Todos		G511057	142652 ⁵⁴		G51742
95-97	Todos		G44450 ⁹⁸		G51742



A6 QUATTRO READYMOUNTS

		Delantero	Trasero
00-04	Izquierdo	G57135 ⁴⁰
	Derecho	G57136 ⁴⁰



A6 READYMOUNTS

		Delantero	Trasero
00-04	Izquierdo	G57135 ⁴⁰
	Derecho	G57136 ⁴⁰



A8

97-99	Todos		142652 ⁵⁴	
-------	-------	---	------	------	------	----------------------	------	---	------	------	------	------	------



COUPE

83-87	Todos		G44902 ⁹⁸	142195 ⁵³		G51013
-------	-------	---	----------------------	------	------	----------------------	------	---	--------	------	------	------	------



COUPE QUATTRO

90-91	Todos		G44902 ⁹⁸	142195 ⁵³	
-------	-------	---	----------------------	------	------	----------------------	------	---	------	------	------	------	------





FOX

73-79	Todos		G44902 ⁹⁸	143059	
-------	-------	---	----------------------	------	------	--------	------	---	------	------	------	------	------



Q3

13-15	Todos		G56899		G51993
-------	-------	---	--------	------	------	------	------	---	--------	------	------	------	------





S4

00-02	Todos		142652 ⁵⁴	
92-94	Todos		G44450 ⁹⁸	

S6

95-97	Todos		G44450 ⁹⁸	
-------	-------	---	----------------------	------	------	------	------	---	------	------	------	------	------

TT

08-09	Todos		143344 ⁵³		143345 ⁵³
00-06	Todos		G56611	142651 ⁵⁴		69420	142654 ⁵³

40 Strut ReadyMount. Ensemble Completo



54 Kit con Montaje y Rodamiento. Es probable que reutilizar algunas partes del E.O.

53 Montaje de Strut. Es probable reutilizar algunas partes del E.O.

98 Nota: El nivel de dificultad para instalar este producto es moderadamente alto. Por favor revise las instrucciones cuidadosamente antes de comenzar.

Texto en Negritas - Número de Parte Nuevo / Futuro

AMORTIGUADORES Y STRUTS

Año	Notas de Aplicación										
		Ultra	ProGuard\ Guardian	LTV\ Max Control	Protector de Strut\ Bases de Strut	HiJacker\ Soporte\ Hidráulico	Ultra	ProGuard\ Guardian	LTV\ Max Control	Protector de Strut\ Bases de Strut	HiJacker\ Soporte\ Hidráulico

AUDI TT QUATTRO

AUDI

08-10	Todos	↓	143344 ⁵³	↓	143345 ⁵³
00-06	Todos	↓	G56611	142651 ⁶⁴	○	69416

V8 QUATTRO

90-94	Todos	↓	G44450 ⁹⁸	↓
-------	-------	---	----------------------	------	------	------	------	---	------	------	------	------	------

AVANTI II

AVANTI

89-91	Todos	○	69600	○	69724
87-88	Todos	○	69600	○	69604

BMW 118i

BMW

12-12	Izquierdo	↓	G52142	↓	70045
	Derecho	↓	G52143	↓	70045

128i

08-11	Izquierdo	↓	G52142	↓	70045
	Derecho	↓	G52143	↓	70045

125i 130i 135i

05-13	Exc. Suspension deportiva Izquierdo	↓	G52142	↓	70045
	Exc. Suspension deportiva Derecho	↓	G52143	↓	70045

318

86	1.8L 4Cyl (110) 2BBL	↓	G44745	○	69725
----	----------------------	---	--------	------	------	------	------	---	-------	------	------	------	------

318i

92-98	Izquierdo	↓	G56602	○	69863	142135 ⁵³
	Derecho	↓	G56603	○	69863	142135 ⁵³
91	Todos	↓	G44745 ⁹⁸	○	69725	142135 ⁵³
84-85	Todos	↓	G44745 ⁹⁸	○	69725	142135 ⁵³

318IS

92-98	Izquierdo	↓	G56602	○	69863	142135 ⁵³
	Derecho	↓	G56603	○	69863	142135 ⁵³
91	Todos	↓	G44745 ⁹⁸	○	69725	142135 ⁵³

318TI

95-99	Izquierdo	↓	G56602	○	69903	142135 ⁵³
	Derecho	↓	G56603	○	69903	142135 ⁵³

320i





77-83	Todos	↓	G44713 ⁹⁸	↓	G51007
-------	-------	---	----------------------	------	------	------	------	---	--------	------	------	------	------

53 Montaje de Strut. Es probable reutilizar algunas partes del E.O.

54 Kit con Montaje y Rodamiento. Es probable que reutilizar algunas partes del E.O.





98 Nota: El nivel de dificultad para instalar este producto es moderadamente alto. Por favor revise las instrucciones cuidadosamente antes de comenzar.

AMORTIGUADORES Y STRUTS







Año	Notas de Aplicación										
			Ultra	ProGuard\ Guardian	LTV\ Max Control	Protector de Strut\ Bases de Strut	HiJacker\ Soporte\ Hidráulico		Ultra	ProGuard\ Guardian	LTV\ Max Control

BMW 320I







BMW

01-05	Exc. Suspension deportiva Izquierdo		G52237
	Exc. Suspension deportiva Derecho		G52238
01-05	Con Suspension deportiva Izquierdo		G52235
	Con Suspension deportiva Derecho		G52236



323CI

00	Todos		69863
	Coupe		143082 ⁵³	69863
	Coupe Izquierdo Exc. Suspensión Deportiva		G52237 ³	69863
	Coupe Izquierdo Suspensión Deportiva		G52235	69863
	Coupe Derecho Exc. Suspensión Deportiva		G52238 ³	69863
	Coupe Derecho Suspensión Deportiva		G52236	69863





323I

00	Wagon Izquierdo Exc. Suspensión Deportiva		G52237	143082 ⁵³	69863
	Wagon Izquierdo Suspensión Deportiva		G56750	143082 ⁵³	69863
	Wagon Derecho Exc. Suspensión Deportiva		G52238	143082 ⁵³	69863
	Wagon Derecho Suspensión Deportiva		G56751	143082 ⁵³	69863
98-99	E36(Cdigo plataforma del fabricante) Izquierdo		G56604	69863	142135 ⁵³
	E36(Cdigo plataforma del fabricante) Derecho		G56605	69863	142135 ⁵³

325

87-88	Todos		69725	142135 ⁵³
	Exc. Suspensión Deportiva		G44775 ⁹⁸	69725	142135 ⁵³



325CI

01-06	Todos		69863
	Izquierdo Exc. Suspensión Deportiva		G52237	143082 ⁵³	69863
	Izquierdo Suspensión Deportiva		G52235	143082 ⁵³	69863
	Derecho Exc. Suspensión Deportiva		G52238	143082 ⁵³	69863
	Derecho Suspensión Deportiva		G52236	143082 ⁵³	69863

325E

84-87	Exc. Suspensión Deportiva		G44775 ⁹⁸	69725	142135 ⁵³
-------	---------------------------	---	----------------------	------	------	------	------	-------	------	------	----------------------	------

325I



07-14	Exc. Suspension deportiva Izquierdo		G52142	70045
	Exc. Suspension deportiva Derecho		G52143	70045

3 Número de parte futuro

53 Montaje de Strut. Es probable reutilizar algunas partes del E.O.

98 Nota: El nivel de dificultad para instalar este producto es moderadamente alto. Por favor revise las instrucciones cuidadosamente antes de comenzar.

AMORTIGUADORES Y STRUTS

Año	Notas de Aplicación										
		Ultra	ProGuard\ Guardian	LTV\ Max Control	Protector de Strut\ Bases de Strut	HiJacker\ Soporte\ Hidráulico	Ultra	ProGuard\ Guardian	LTV\ Max Control	Protector de Strut\ Bases de Strut	HiJacker\ Soporte\ Hidráulico

BMW

BMW

325I (cont)

06-14	Todos	70045
	Exc. Suspension deportiva Der	G52143
	Exc. Suspensión Deportiva M-Sport Pack II	143082 ⁵³
	Exc. Suspension deportiva Izquierdo	G52142
02-05	Sedan Derecho Exc. Suspensión Deportiva	G52238	69863
01-05	Todos	69863
	Exc. Suspensión Deportiva M-Sport Pack II	143082 ⁵³	69863
	Sedan Izquierdo Exc. Suspensión Deportiva	G52237	69863
	Sedan Derecho Fab. desde 11/01; Exc. Suspensión Deportiva	G52238	69863
	Sedan Izq Fab. hasta 9/01; Wagon Izq. Suspensión Deportiva	G56750	69863
	Sedan Der Fab. hasta 9/01; Wagon Der. Suspensión Deportiva	G56751	69863
95	E36(Cdigo plataforma del fabricante)	142135 ⁵³
	E36(Cdigo plataforma del fabricante) E36	69863
	E36(Cdigo plataforma del fabricante) Izquierdo	G56604
	E36(Cdigo plataforma del fabricante) Derecho	G56605
92-94	E36(Cdigo plataforma del fabricante) Izquierdo	G56604	69863	142135 ⁵³
	E36(Cdigo plataforma del fabricante) Derecho	G56605	69863	142135 ⁵³
92	E30(Cdigo plataforma del fabricante) Exc. Suspensión Deportiva	G44775 ⁹⁸	69725
87-91	Todos	142135 ⁵³
	E30(Cdigo plataforma del fabricante) Exc. Suspensión Deportiva	G44775 ⁹⁸	69725	142135 ⁵³

325IS

87-92	Todos	69725	142135 ⁵³
	Exc. Suspensión Deportiva	G44775 ⁹⁸	69725	142135 ⁵³

325IX

88-91	Todos	142135 ⁵³
-------	-------	------	------	------	------	------	------	------	------	----------------------	------



328CI

00	Todos	143082 ⁵³	69863
	Izquierdo Suspensión Deportiva	G52235	143082 ⁵³	69863
	Derecho Suspensión Deportiva	G52236	143082 ⁵³	69863

53 Montaje de Strut. Es probable reutilizar algunas partes del E.O.

98 Nota: El nivel de dificultad para instalar este producto es moderadamente alto. Por favor revise las instrucciones cuidadosamente antes de comenzar.





AMORTIGUADORES Y STRUTS

Año	Notas de Aplicación	Front					Rear				
			Ultra	ProGuard\ Guardian	LTV\ Max Control	Protector de Strut\ Bases de Strut	HiJacker\ Soporte\ Hidráulico		Ultra	ProGuard\ Guardian	LTV\ Max Control











BMW

BMW



















328Ci (cont)

00	Coupe Izquierdo Exc. Suspensión Deportiva		G52237 ³	143082 ⁵³		69863
	Coupe Derecho Exc. Suspensión Deportiva		G52238 ³	143082 ⁵³		69863











328i

07-13	Izquierdo		G52142		70045
	Derecho		G52143		70045
99-00	Todos		143082 ⁵³		69863
96-98	Izquierdo		G56604		69863	142135 ⁵³
	Derecho		G56605		69863	142135 ⁵³







330Ci

02-06	Derecho Suspensión Deportiva		G52236		69863
01-06	Todos			69863
	Exc. Suspensión Deportiva M-Sport Pack II		143082 ⁵³		69863
	Izquierdo Suspensión Deportiva		G52235		69863
	Convertible Izquierdo Exc. Suspensión Deportiva		G52237		69863
	Convertible Derecho Exc. Suspensión Deportiva		G52238		69863
01	Convertible Izquierdo Suspensión Deportiva		G56750		69863
	Convertible Derecho Suspensión Deportiva		G56751		69863
	Coupe Derecho Suspensión Deportiva		G52236		69863



330i

07-11	Izquierdo		G52142		70045
	Derecho		G52143		70045
02-05	Derecho Suspensión Deportiva		G52236		69863
01-05	Todos			69863
	Izquierdo Suspensión Deportiva		G52235		69863

335i

11-13	Derecho		G52143		70045
07-13	Izquierdo		G52142		70045
07-10	Todos			70045

524TD

85-86	Todos			G51330
-------	-------	---	------	------	------	------	------	---	--------	------	------	------	------

3 Número de parte futuro

53 Montaje de Strut. Es probable reutilizar algunas partes del E.O.

AMORTIGUADORES Y STRUTS

Año	Notas de Aplicación	Front					Rear				
		Ultra	ProGuard\ Guardian	LTV\ Max Control	Protector de Strut\ Bases de Strut	HiJacker\ Soporte\ Hidráulico	Ultra	ProGuard\ Guardian	LTV\ Max Control	Protector de Strut\ Bases de Strut	HiJacker\ Soporte\ Hidráulico

BMW

BMW

525i

08	Todos	↑	G51900
04-07	Todos	↑	G52314	↑	G51900
01-03	Sedan Exc. Suspensión Electrónica Ajustable	↑	G56608	↑	G51216
	Wagon Exc. Suspensión Electrónica Ajustable	↑	↑	69998
92-95	Todos	↑	↑	G51346
	Exc. Suspensión Electrónica Ajustable	↑	G44493 ⁹⁸	↑	G51346	142735 ⁵³
92	Fabricado antes de Sep/92	↑	G44497 ⁹⁸	↑	G51346
91	Todos	↑	G44497 ⁹⁸	↑	G51346	142735 ⁵³
90	Todos	↑	↑	142735 ⁵³
	Fab. desde 8/90	↑	G44497 ⁹⁸	↑	G51346	142735 ⁵³
	Fab. hasta 8/90	↑	G44991 ⁹⁸	↑	142735 ⁵³
89	Todos	↑	↑	G51346	142735 ⁵³
	Fab. hasta 8/90	↑	G44991 ⁹⁸	↑	G51346	142735 ⁵³
86	Todos	↑	G44991	↑

528E

82-88	Sistema Autonivelable	↑	G44920 ⁹⁸	↑	G51330
-------	-----------------------	---	----------------------	-------	-------	-------	---	--------	-------	-------	-------	-------

528i

08-10	Todos	↑	G52314	↑
99-00	Todos	↑	143082 ⁵³	↑
	Wagon	↑	143082 ⁵³	↑	69998
97-00	Sedan	↑	G56608	143082 ⁵³	↑	G51216
97-98	Todos	↑	143082 ⁵³	↑	G51216

530i

08	Todos	↑	↑	G51900
04-07	Todos	↑	G52314	↑	G51900
01-03	Exc. Suspensión Electrónica Ajustable	↑	G56608	↑	G51216
94-95	Sedan	↑	G44497 ⁹⁸	↑	G51346	142735 ⁵³



533i

83-84	Sistema Autonivelable	↑	G44920 ⁹⁸	↑	G51330
-------	-----------------------	---	----------------------	-------	-------	-------	---	--------	-------	-------	-------	-------

53 Montaje de Strut. Es probable reutilizar algunas partes del E.O.

98 Nota: El nivel de dificultad para instalar este producto es moderadamente alto. Por favor revise las instrucciones cuidadosamente antes de comenzar.













AMORTIGUADORES Y STRUTS

Año	Notas de Aplicación	Front					Rear				
			ProGuard\ Guardian	LTV\ Max Control	Protector de Strut\ Bases de Strut	HiJacker\ Soporte\ Hidráulico		ProGuard\ Guardian	LTV\ Max Control	Protector de Strut\ Bases de Strut	HiJacker\ Soporte\ Hidráulico







BMW

BMW







535I

08-10	Todos		G52314		
90-93	Fab. desde 8/90		G44497 ⁹⁸		G51346	142735 ⁵³
89-90	Fab. hasta 8/90		G44991 ⁹⁸
89	Fab. desde 8/90			G51346	142735 ⁵³
85-88	Sistema Autonivelable		G44920 ⁹⁸		G51330
88	Fab. desde 8/90			142735 ⁵³
	Fab. desde 8/90; Exc. Sistema de Autonivelación			G51346
	Fab. hasta 8/90; Exc. Sistema de Autonivelación		G44991 ⁹⁸

535IS

88	Todos			142735 ⁵³
	Exc. Sistema de Autonivelación		G44991 ⁹⁸		G51346	142735 ⁵³
	Sistema Autonivelable		G44920 ⁹⁸		G51330	142735 ⁵³

540I

00-03	Wagon Exc. Suspensión Electrónica Ajustable			69998
97-03	Fab. hasta 10/03, Exc. Suspensión Electrónica Ajustable		G56607		G51216
95	Fab. hasta 10/03, Exc. Suspensión Electrónica Ajustable		G44497 ⁹⁸		G51216
94	Fab. hasta 10/03, Exc. Suspensión Electrónica Ajustable		G44497 ⁹⁸



545I

04-05	Todos		G52314
-------	-------	---	--------	------	------	------	------	------	------	------	------	------	------	------	------

550I

06-10	Todos		G52314
-------	-------	---	--------	------	------	------	------	------	------	------	------	------	------	------	------

635CSI

85-89	Exc. Sistema de Autonivelación		G44920 ⁹⁸		G51330
-------	--------------------------------	---	----------------------	------	------	------	------	------	------	---	--------	------	------	------	------







735I

88-90	Todos		G44969 ⁹⁸
-------	-------	---	----------------------	------	------	------	------	------	------	------	------	------	------	------	------

735IL

88-92	Todos		G44969 ⁹⁸
-------	-------	---	----------------------	------	------	------	------	------	------	------	------	------	------	------	------

740I

97-01	Izquierdo Exc. Suspensión Electrónica Ajustable		G56771		G51744
	Derecho Exc. Suspensión Electrónica Ajustable		G56770		G51744
94-95	Izquierdo Exc. Suspensión Electrónica Ajustable		G56771		G51744

53 Montaje de Strut. Es probable reutilizar algunas partes del E.O.

98 Nota: El nivel de dificultad para instalar este producto es moderadamente alto. Por favor revise las instrucciones cuidadosamente antes de comenzar.

AMORTIGUADORES Y STRUTS

Año	Notas de Aplicación	Front					Rear				
		Ultra	ProGuard\ Guardian	LTV\ Max Control	Protector de Strut\ Bases de Strut	HiJacker\ Soporte\ Hidráulico	Ultra	ProGuard\ Guardian	LTV\ Max Control	Protector de Strut\ Bases de Strut	HiJacker\ Soporte\ Hidráulico

BMW

BMW

740I (cont)

94-95	Derecho Exc. Suspensión Electrónica Ajustable	G56770	G51744
-------	---	--------	------	------	------	------	--------	------	------	------	------

740IL

94-01	Izquierdo Exc. Suspensión Electrónica Ajustable	G56771	G51744
	Derecho Exc. Suspensión Electrónica Ajustable	G56770	G51744

745I

02-05	Todos	G511070
-------	-------	------	------	------	------	------	---------	------	------	------	------

745LI

02-05	Todos	G511070
-------	-------	------	------	------	------	------	---------	------	------	------	------

750I

06-08	Todos	G511070
-------	-------	------	------	------	------	------	---------	------	------	------	------

750IL

97-01	Izquierdo Exc. Suspensión Electrónica Ajustable	G56771
	Derecho Exc. Suspensión Electrónica Ajustable	G56770
94-96	Todos	G51744
	Izquierdo Exc. Suspensión Electrónica Ajustable	G56771	G51744
	Derecho Exc. Suspensión Electrónica Ajustable	G56770	G51744

750LI

06-08	Todos	G511070
-------	-------	------	------	------	------	------	---------	------	------	------	------

760I

04-06	Todos	G511070
-------	-------	------	------	------	------	------	---------	------	------	------	------

760LI

03-08	Todos	G511070
-------	-------	------	------	------	------	------	---------	------	------	------	------

M3

95-99	Izquierdo	142826 ⁵³
88-91	Todos	69725	142135 ⁵³

X3

04-10	Izquierdo	G52199	70034
	Derecho	G52200	70034

X5

00-06	Todos	G64046	143259 ⁵³
	AWD	143084 ⁵³	G64046	143259 ⁵³
	Coil(FrontSpringType) Izquierdo	G52144	G64046	143259 ⁵³

53 Montaje de Strut. Es probable reutilizar algunas partes del E.O.

AMORTIGUADORES Y STRUTS

Año	Notas de Aplicación	Front					Rear				
		Ultra	ProGuard\ Guardian	LTV\ Max Control	Protector de Strut\ Bases de Strut	HiJacker\ Soporte\ Hidráulico	Ultra	ProGuard\ Guardian	LTV\ Max Control	Protector de Strut\ Bases de Strut	HiJacker\ Soporte\ Hidráulico

BMW

BMW

X5 (cont)

00-06	Coil(FrontSpringType) Derecho	G52145	IO	G64046	143259 ⁵³
-------	-------------------------------	--------	------	------	------	------	----	--------	------	------	----------------------	------

Z3

96-02	Izquierdo	G56761	IO
	Derecho	G56760	IO

BUICK

BUICK

ALLURE

10	AWD, Izquierdo Exc. Suspensión Electrónica Ajustable	G52600	IO	G511074
	AWD, Derecho Exc. Suspensión Electrónica Ajustable	G52601	IO	G511074
	FWD	IO	70059
	FWD, Izquierdo Exc. Suspensión Electrónica Ajustable	G52278	IO
	FWD, Derecho Exc. Suspensión Electrónica Ajustable	G52279	IO
05-09	Todos	G55948	142524 ⁵⁸ 142525 ⁵³ 142526 ⁵⁴	IO
	Exc. Modelos c/ Ruedas de 17" o 18"	G55948	142524 ⁵⁸ 142525 ⁵³ 142526 ⁵⁴	IO	G55949
	Izquierdo	G55948	142524 ⁵⁸ 142525 ⁵³ 142526 ⁵⁴	IO	143073 ⁵³
	Modelos con Llantas de 17" o 18"	G55948	142524 ⁵⁸ 142525 ⁵³ 142526 ⁵⁴	IO	G52244
	Derecho	G55948	142524 ⁵⁸ 142525 ⁵³ 142526 ⁵⁴	IO	143074 ⁵³

ALLURE READYMOUNTS

							Delantero	Trasero
05-09	Todos						G57060 ⁴⁰
	Izquierdo Exc. Modelos c/ Ruedas de 17" o 18"						G57060 ⁴⁰	G56924 ⁴⁰
	Derecho Exc. Modelos c/ Ruedas de 17" o 18"						G57060 ⁴⁰	G56925 ⁴⁰

APOLLO

74-75	Todos	IO	69600	81494	34051 ⁸	IO	82093	49193 ⁷
73	Todos	IO	69600	81494	34051 ⁸	IO
	Exc. Suspensión HD	IO	69600	81494	34051 ⁸	IO	82093	49193 ⁷
	Suspensión HD	IO	69600	81494	34051 ⁸	IO	69724	81514	49157 ⁷

CENTURION

71-73	Todos	IO	69675 ⁵	81446	34073 ⁸	IO	69724 ⁵	81514	43049 ⁹ 49131 ⁹⁰
-------	-------	----	--------------------	-------	------	------	--------------------	----	--------------------	-------	------	------	---

CENTURY

97-05	Izquierdo	G55948	142524 ⁵⁸ 142525 ⁵³ 142526 ⁵⁴	IO	G55949	143073 ⁵³
	Derecho	G55948	142524 ⁵⁸ 142525 ⁵³ 142526 ⁵⁴	IO	G55949	143074 ⁵³

5 Use el kit 140719 para reemplazar partes del EO de montaje inferior cuando los pernos se rompan o los tornillos autoroscantes no se puedan utilizar más.

8 Paquetes en pares

40 Strut ReadyMount. Ensamble Completo

54 Kit con Montaje y Rodamiento. Es probable que reutilizar algunas partes del E.O.

Texto en Negritas - Número de Parte Nuevo / Futuro

7 Paquetes en pares; kit de mangueras de aire incluido

30 Para Vehículos GM equipados con sistemas de nivelación de fábrica, vea Ref. A.

53 Montaje de Strut. Es probable reutilizar algunas partes del E.O.

58 El Kit de Montaje incluye: Rodamiento de Suspensión. Es probable reutilizar algunas partes del E.O.

AMORTIGUADORES Y STRUTS

Año	Notas de Aplicación	Front					Rear				
		Ultra	ProGuard\ Guardian	LTV\ Max Control	Protector de Strut\ Bases de Strut	HiJacker\ Soporte\ Hidráulico	Ultra	ProGuard\ Guardian	LTV\ Max Control	Protector de Strut\ Bases de Strut	HiJacker\ Soporte\ Hidráulico

BUICK

BUICK

CENTURY (cont)

85-96	Todos	142223 ⁵³ 142749 ⁶⁵	69723	81517	141974 ⁵³	49370 ³⁰ 42517
84-96	Suspensión HD	G55514	42517
82-96	Todos	42517
84	Todos	142223 ⁵³	69723	81517	141974 ⁵³	49370 ³⁰ 42517
	Exc. Suspensión HD	G55505	42517
82-83	Todos	G55505	142223 ⁵³	69723	81517	141974 ⁵³	49370 ³⁰ 42517
78-81	Todos	69600	81494	34051 ⁸	69604	81492	43060 ⁸ 49334 ³⁰
73-77	Todos	69600	81494	34051 ⁸	69604	81492	43060 ⁸ 49152 ³⁰
58	Todos	81270	82156
57	Todos	82156
56	Todos	82087

CENTURY READYMOUNTS

		Delantero	Trasero
97-05	Izquierdo	G57060 ⁴⁰	G56924 ⁴⁰
	Derecho	G57060 ⁴⁰	G56925 ⁴⁰
85-96	Todos	G56908 ⁴⁰
84	Suspensión HD	G56908 ⁴⁰

COMMERCIAL CHASSIS

92-96	Todos	43049 ⁸
-------	-------	-------	-------	-------	-------	-------	-------	-------	-------	-------	--------------------

ELECTRA

85-90	Todos	G56701	142227 ⁵⁸	142132 ⁵³
	Air(RearSpringType) Reemplazo Tipo Convencional para Susp. Trasera Asistida por Aire	G56701	142227 ⁵⁸	G56707 ⁹	142132 ⁵³
	Air(RearSpringType) w/Air assist Rear Susp. Std. Equip. Strut Only	G56701	142227 ⁵⁸	G56903	142132 ⁵³
85-89	Estate Wagon	G56701	142227 ⁵⁸	34073 ⁸	142132 ⁵³
71-84	Todos	69675 ⁵	81446	34073 ⁸	69724	81514	43049 ⁸ 49131 ³⁰
65-70	Todos	82601	82602
61-64	Todos	82087	82609
59-60	Exc. Suspensión de Aire	82155

ELECTRA READYMOUNTS

		Delantero	Trasero
85-90	Todos	G56914 ⁴⁰
	Air(RearSpringType) c/ Strut Trasero de Aire c/ Montaje Superior	G56914 ⁴⁰	G56906 ⁴³
	Air(RearSpringType) Reemplazo Convencional para Strut Trasero de Aire c/ Montaje Superior	G56914 ⁴⁰	G56726 ⁴

4 Número de futuro, las cantidades disponibles Q4 2016.

8 Paquetes en pares

30 Para Vehículos GM equipados con sistemas de nivelación de fábrica, vea Ref. A.

43 Strut ReadyMount, no incluye resortes por el diseño del vehículo. Consulte la Ref.

D para el procedimiento de reemplazo en una Susp. Elec. Ajustable con un producto no ajustable

58 El Kit de Montaje incluye: Rodamiento de Suspensión. Es probable reutilizar algunas partes del E.O.

Texto en Negritas - Número de Parte Nuevo / Futuro

5 Use el kit 140719 para reemplazar partes del EO de montaje inferior cuando los pernos se rompan o los tornillos autoroscantes no se puedan utilizar más.



9 Vea Ref.D para los procedimientos de reemplazo de una Susp. Elect. Ajust. con un producto no ajust.

40 Strut ReadyMount. Ensamble Completo

53 Montaje de Strut. Es probable reutilizar algunas partes del E.O.

65 El Kit de Montaje incluye: Asiento de Resorte Superior con Aislador. Es probable reutilizar algunas partes del E.O.



AMORTIGUADORES Y STRUTS

Año	Notas de Aplicación	Front					Rear				
			ProGuard/ Guardian	LTV/ Max Control	Protector de Strut/ Bases de Strut	HiJacker/ Soporte/ Hidráulico		ProGuard/ Guardian	LTV/ Max Control	Protector de Strut/ Bases de Strut	HiJacker/ Soporte/ Hidráulico

BUICK

BUICK





ENCLAVE

13-16	Todos	 G64040
08-12	Todos	 G52125	143366	 G64040



ENCLAVE READYMOUNTS

							Delantero	Trasero
08-12	Todos						G57109⁴⁰



ESTATE WAGON

71-83	Todos	 69675 ⁵	81446	34073 ⁸	 69604	81492	43060 ⁹ 49152 ³⁰
70	Todos		82601	 69724	81514	49128 ³⁰





GRAN SPORT

65-67	Todos		82138	 69604	81492	43060 ⁹ 49152 ³⁰
-------	-------	---	-------	-------	-------	-------	---	-------	-------	-------	---















GS / GS350 / GS400 / GS455

68-72	Todos	 69600	81494	 69604	81492	43060 ⁹ 49152 ³⁰
-------	-------	---	-------	-------	-------	-------	---	-------	-------	-------	---

INVICTA

61-63	Todos		82087		82609
59-60	Exc. Suspensión de Aire			82155

LACROSSE

12-13	FWD, Exc. Suspensión Electrónica	 70059
10-12	AWD, Izquierdo Exc. Suspensión Electrónica Ajustable	 G52600	 G511074
	AWD, Derecho Exc. Suspensión Electrónica Ajustable	 G52601	 G511074
	FWD, Izquierdo Exc. Suspensión Electrónica Ajustable	 G52278
	FWD, Derecho Exc. Suspensión Electrónica Ajustable	 G52279
10-11	FWD	 70059
05-09	Todos	 G55948	142524 ⁵⁸ 142525 ⁵³ 142526 ⁵⁴
	Exc. Modelos c/ Ruedas de 17" o 18"	 G55948	142524 ⁵⁸ 142525 ⁵³ 142526 ⁵⁴	 G55949
	Izquierdo	 G55948	142524 ⁵⁸ 142525 ⁵³ 142526 ⁵⁴	143073 ⁵³
	Modelos con Llantas de 17" o 18"	 G55948	142524 ⁵⁸ 142525 ⁵³ 142526 ⁵⁴	 G52244
	Derecho	 G55948	142524 ⁵⁸ 142525 ⁵³ 142526 ⁵⁴	143074 ⁵³

LACROSSE READYMOUNTS

							Delantero	Trasero
05-09	Todos						G57060⁴⁰
	Izquierdo Exc. Modelos c/ Ruedas de 17" o 18"						G57060⁴⁰	G56924⁴⁰
	Derecho Exc. Modelos c/ Ruedas de 17" o 18"						G57060⁴⁰	G56925⁴⁰

5 Use el kit 140719 para reemplazar partes del EO de montaje inferior cuando los pernos se rompan o los tornillos autoroscantes no se puedan utilizar más.

30 Para Vehículos GM equipados con sistemas de nivelación de fábrica, vea Ref. A.

53 Montaje de Strut. Es probable reutilizar algunas partes del E.O.

58 El Kit de Montaje incluye: Rodamiento de Suspensión. Es probable reutilizar algunas partes del E.O.

8 Paquetes en pares

40 Strut ReadyMount. Ensamble Completo

54 Kit con Montaje y Rodamiento. Es probable que reutilizar algunas partes del E.O.

Texto en Negritas - Número de Parte Nuevo / Futuro

AMORTIGUADORES Y STRUTS

Año	Notas de Aplicación	Front					Rear				
		Ultra	ProGuard\ Guardian	LTV\ Max Control	Protector de Strut\ Bases de Strut	HiJacker\ Soporte\ Hidráulico	Ultra	ProGuard\ Guardian	LTV\ Max Control	Protector de Strut\ Bases de Strut	HiJacker\ Soporte\ Hidráulico

BUICK

BUICK

LESABRE

00-05	Todos	G56509	142524 ⁵⁸ 142640 ⁵⁴	↑	142647 ⁵³
	Con Entradas de Aire de EO	G56509	142524 ⁵⁸ 142640 ⁵⁴	↑	142647 ⁵³	49255
	sin conexión de aire OE Estilo	G56509	142524 ⁵⁸ 142640 ⁵⁴	↑	142647 ⁵³	49228 ³⁰
97-99	Todos	G56718 ⁹	142524 ⁵⁸ 142751 ⁶⁵	↑	142132 ⁵³
	Air(RearSpringType) Sistema de Autonivelación NIVOMAT de EO opcional	G56718 ⁹	142524 ⁵⁸ 142751 ⁶⁵	↑	G56903	142132 ⁵³
	Coil(RearSpringType)	G56718 ⁹	142524 ⁵⁸ 142751 ⁶⁵	↑	G56707 ⁹	142132 ⁵³
91-96	Todos	G56718 ⁹	142226 ⁵⁴ 142751 ⁶⁵	↑	142132 ⁵³
	Air(RearSpringType) Sistema de Autonivelación NIVOMAT de EO opcional	G56718 ⁹	142226 ⁵⁴ 142751 ⁶⁵	↑	G56903	142132 ⁵³
	Coil(RearSpringType)	G56718 ⁹	142226 ⁵⁴ 142751 ⁶⁵	↑	G56707 ⁹	142132 ⁵³
90	Todos	142226 ⁵⁴ 142227 ⁵⁸ 142752 ⁶⁵	↑	142132 ⁵³
	Strut Delantero de Diseño Inicial c/ Resorte de Seguridad	G56701	142226 ⁵⁴ 142227 ⁵⁸ 142752 ⁶⁵	↑	142132 ⁵³
	Strut Delantero de Segundo Diseño sin Resorte de Seguridad	G56718 ⁹	142226 ⁵⁴ 142227 ⁵⁸ 142752 ⁶⁵	↑	142132 ⁵³
	Air(RearSpringType) Sistema de Autonivelación NIVOMAT de EO opcional	142226 ⁵⁴ 142227 ⁵⁸ 142752 ⁶⁵	↑	G56903	142132 ⁵³
	Coil(RearSpringType)	142226 ⁵⁴ 142227 ⁵⁸ 142752 ⁶⁵	↑	G56707 ⁹	142132 ⁵³
88-89	Todos	G56701	142227 ⁵⁸ 142752 ⁶⁵	34073 ⁸	↑	142132 ⁵³
	Air(RearSpringType) Sistema de Autonivelación NIVOMAT de EO opcional	G56701	142227 ⁵⁸ 142752 ⁶⁵	34073 ⁸	↑	G56903	142132 ⁵³
	Coil(RearSpringType)	G56701	142227 ⁵⁸ 142752 ⁶⁵	34073 ⁸	↑	G56707 ⁹	142132 ⁵³
86-87	Todos	G56701	142227 ⁵⁸ 142752 ⁶⁵	↑	142132 ⁵³
	Air(RearSpringType) Sistema de Autonivelación NIVOMAT de EO opcional	G56701	142227 ⁵⁸ 142752 ⁶⁵	↑	G56903	142132 ⁵³
	Coil(RearSpringType)	G56701	142227 ⁵⁸ 142752 ⁶⁵	↑	G56707 ⁹	142132 ⁵³
71-85	Todos	69675 ⁵	81446	34073 ⁸	⊗	69724	81514	43049 ⁶ 49131 ³⁰
65-70	Todos	82601	⊗	82602
61-64	Todos	82087	⊗	82609
59-60	Exc. Suspensión de Aire	⊗	82155

LESABRE READYMOUNTS

		Delantero	Trasero
00-05	Exc. Suspensión Electrónica Ajustable	G57051¹⁰

5 Use el kit 140719 para reemplazar partes del EO de montaje inferior cuando los pernos se rompan o los tornillos autoroscantes no se puedan utilizar más.
 9 Vea Ref.D para los procedimientos de reemplazo de una Susp. Elect. Ajust. con un producto no ajust.
 40 Strut ReadyMount. Ensamble Completo
 54 Kit con Montaje y Rodamiento. Es probable que reutilizar algunas partes del E.O.
 65 El Kit de Montaje incluye: Asiento de Resorte Superior con Aislador. Es probable reutilizar algunas partes del E.O.

8 Paquetes en pares
 30 Para Vehículos GM equipados con sistemas de nivelación de fábrica, vea Ref. A.
 53 Montaje de Strut. Es probable reutilizar algunas partes del E.O.
 58 El Kit de Montaje incluye: Rodamiento de Suspensión. Es probable reutilizar algunas partes del E.O.

Texto en Negritas - Número de Parte Nuevo / Futuro

AMORTIGUADORES Y STRUTS

Año	Notas de Aplicación	Front					Rear				
		Ultra	ProGuard\ Guardian	LTV\ Max Control	Protector de Strut\ Bases de Strut	HiJacker\ Soporte\ Hidráulico	Ultra	ProGuard\ Guardian	LTV\ Max Control	Protector de Strut\ Bases de Strut	HiJacker\ Soporte\ Hidráulico

BUICK

BUICK

LESABRE READYMOUNTS (cont)

		Delantero	Trasero
91-99	Todos	G56909 ⁴
	Air(RearSpringType) Sistema de Autonivelación NIVOMAT de EO opcional	G56909 ⁴	G56906 ³³
	Coil(RearSpringType)	G56909 ⁴	G56726 ³³
90	Strut Delantero de Diseño Inicial c/ Resorte de Seguridad	G56914 ⁴⁰
	Strut Delantero de Diseño Tardío sin Resorte de Seguridad	G56909 ⁴
	Air(RearSpringType) Sistema de Autonivelación NIVOMAT de EO opcional	G56906 ³³
	Coil(RearSpringType)	G56726 ³³
86-89	Todos	G56914 ⁴⁰
	Air(RearSpringType) Sistema de Autonivelación NIVOMAT de EO opcional	G56914 ⁴⁰	G56906 ³³
	Coil(RearSpringType)	G56914 ⁴⁰	G56726 ³³

LIMITED

58	Todos	81270	82156
----	-------	-------	------	------	------	-------	------	------	------

LUCERNE

06-11	Todos	49228 ³⁰
	Exc. Suspensión Magnética de Control de Manejo	G52116	49228 ³⁰

PARK AVENUE

98-05	Todos	G56508	142524 ⁵⁸ 142640 ⁵⁴	142647 ⁵³
	Con Entradas de Aire de EO	G56508	142524 ⁵⁸ 142640 ⁵⁴	142647 ⁵³	49255
	sin conexión de aire OE Estilo	G56508	142524 ⁵⁸ 142640 ⁵⁴	142647 ⁵³	49228 ³⁰
97	Todos	G55878	142524 ⁵⁸	142647 ⁵³
	Con Entradas de Aire de EO	G55878	142524 ⁵⁸	142647 ⁵³	49255
	sin conexión de aire OE Estilo	G55878	142524 ⁵⁸	142647 ⁵³	49228 ³⁰
91-96	Todos	G56718 ⁹	142226 ⁵⁴ 142227 ⁵⁸ 142751 ⁶⁵	142132 ⁵³
	Air(RearSpringType) Exc. Suspensión Electrónica Ajustable	G56718 ⁹	142226 ⁵⁴ 142227 ⁵⁸ 142751 ⁶⁵	G56903 ⁹	142132 ⁵³
	Air(RearSpringType) Reemplazo Tipo Convencional para Susp. Trasera Asistida por Aire; Exc. Susp. Elect.	G56718 ⁹	142226 ⁵⁴ 142227 ⁵⁸ 142751 ⁶⁵	G56707 ⁹	142132 ⁵³

PARK AVENUE READYMOUNTS

		Delantero	Trasero
98-05	Todos	G56929 ⁴⁰
91-96	Manejo con Comando Computarizado (CCR)	G56909 ⁴
	Air(RearSpringType)	G56906 ³³
	Air(RearSpringType) Reemplazo Convencional para Suspensión Asistida; Exc. Susp. Elec. Ajustable	G56726 ³²

RAINIER

04-07	Todos	G51718	143241 ⁵³	61717
-------	-------	--------	------	------	----------------------	------	-------	------	------

4 Número de futuro, las cantidades disponibles Q4 2016.

30 Para Vehículos GM equipados con sistemas de nivelación de fábrica, vea Ref. A.

42 Strut ReadyMount, no incluye resortes por el diseño del vehículo.

53 Montaje de Strut. Es probable reutilizar algunas partes del E.O.

58 El Kit de Montaje incluye: Rodamiento de Suspensión. Es probable reutilizar algunas partes del E.O.

9 Vea Ref.D para los procedimientos de reemplazo de una Susp. Elect. Ajust. con un producto no ajust.

40 Strut ReadyMount. Ensamble Completo

43 Strut ReadyMount, no incluye resortes por el diseño del vehículo. Consulte la Ref.

D para el procedimiento de reemplazo en una Susp. Elec. Ajustable con un producto no ajustable

54 Kit con Montaje y Rodamiento. Es probable que reutilizar algunas partes del E.O.

65 El Kit de Montaje incluye: Asiento de Resorte Superior con Aislador. Es probable reutilizar algunas partes del E.O.

Texto en Negritas - Número de Parte Nuevo / Futuro

AMORTIGUADORES Y STRUTS

Año	Notas de Aplicación	From					Rear				
		Ultra	ProGuard\ Guardian	LTV\ Max Control	Protector de Strut\ Bases de Strut	HiJacker\ Soporte\ Hidráulico	Ultra	ProGuard\ Guardian	LTV\ Max Control	Protector de Strut\ Bases de Strut	HiJacker\ Soporte\ Hidráulico

BUICK

BUICK

RAINIER (cont)

04-07	Coil(FrontSpringType)	G51718	143241 ⁵³	G63842	61717
-------	-----------------------	--------	------	------	----------------------	------	--------	-------	------	------	------

RAINIER READYMOUNTS

04-07	Todos							Delantero		Trasero	
								G57022 ⁴⁰		

REATA

90-91	Todos	G56717 ⁹	142297 ⁵⁴	142405 ⁵³
88-89	Todos	G56717 ⁹	142298 ⁵⁴	142405 ⁵³

REGAL

11-12	Izquierdo Exc. Suspensión Activa	G52435	G51982
	Derecho Exc. Suspensión Activa	G52436	G51982
97-04	Todos	G55948	142524 ⁵⁸ 142525 ⁵³ 142526 ⁵⁴
	Exc. Modelos c/ Ruedas de 17" o 18"	G55948	142524 ⁵⁸ 142525 ⁵³ 142526 ⁵⁴	G55949
	Izquierdo	G55948	142524 ⁵⁸ 142525 ⁵³ 142526 ⁵⁴	143073 ⁵³
	Derecho	G55948	142524 ⁵⁸ 142525 ⁵³ 142526 ⁵⁴	143074 ⁵³
88-96	Todos	G44459 ³⁶	142143 ⁵³	G56708
78-87	Todos	69600	81494	34051 ⁸	69604	81492	43060 ⁸ 49334 ³⁰
73-77	Todos	69600	81494	34051 ⁸	69604	81492	43060 ⁸ 49152 ³⁰

REGAL READYMOUNTS

97-04	Izquierdo							Delantero		Trasero	
								G57060 ⁴⁰		G56924 ⁴⁰	
								G57060 ⁴⁰		G56925 ⁴⁰	
88-96	Todos								G56727 ⁴²	

RENDEZVOUS

02-07	Exc. Sistema de Autonivelación NIVOMAT	143091 ⁵³	G63868	61777
	Exc. Sistema de Autonivelación NIVOMAT	G55834

RIVIERA

98-99	Todos	G56508	142524 ⁵⁸ 142640 ⁵⁴	142647 ⁵³
	Con Entradas de Aire de EO	G56508	142524 ⁵⁸ 142640 ⁵⁴	142647 ⁵³	49255
	Debe usarse con el kit de mangueras incluido	G56508	142524 ⁵⁸ 142640 ⁵⁴	142647 ⁵³	49228 ³⁰
97	Todos	G55878	142751 ⁶⁵	142647 ⁵³

8 Paquetes en pares

30 Para Vehículos GM equipados con sistemas de nivelación de fábrica, vea Ref. A.

40 Strut ReadyMount. Ensamble Completo

53 Montaje de Strut. Es probable reutilizar algunas partes del E.O.

58 El Kit de Montaje incluye: Rodamiento de Suspensión. Es probable reutilizar algunas partes del E.O.

9 Vea Ref.D para los procedimientos de reemplazo de una Susp. Elect. Ajust. con un producto no ajust.

36 Requiere una herramienta especial de instalación para struts.





42 Strut ReadyMount, no incluye resortes por el diseño del vehículo.

54 Kit con Montaje y Rodamiento. Es probable que reutilizar algunas partes del E.O.

65 El Kit de Montaje incluye: Asiento de Resorte Superior con Aislador. Es probable reutilizar algunas partes del E.O.

Texto en Negritas - Número de Parte Nuevo / Futuro























AMORTIGUADORES Y STRUTS

Año	Notas de Aplicación										
			Ultra	ProGuard\ Guardian	LTV\ Max Control	Protector de Strut\ Bases de Strut	HiJacker\ Soporte\ Hidráulico		Ultra	ProGuard\ Guardian	LTV\ Max Control

BUICK

BUICK

RIVIERA (cont)

97	Con Entradas de Aire de EO		G55878	142751 ⁶⁵		142647 ⁵³	49255
	Debe usarse con el kit de mangueras incluido		G55878	142751 ⁶⁵		142647 ⁵³	49228 ³⁰
95-96	Todos		G56718 ⁹	142751 ⁶⁵		142647 ⁵³
	Con Entradas de Aire de EO		G56718 ⁹	142751 ⁶⁵		142647 ⁵³	49255
	Debe usarse con el kit de mangueras incluido		G56718 ⁹	142751 ⁶⁵		142647 ⁵³	49228 ³⁰
90-93	Todos		G56717 ⁹	142297 ⁵⁴		G56704 ⁹	142405 ⁵³
86-89	Todos		G56703	142298 ⁵⁴		G56704 ⁹	142405 ⁵³
79-85	Todos		69706	81445		49345 ³⁰
71-78	Todos		69675 ⁵	81446	34073 ⁸		69724	81514	43049 ⁸ 49131 ³⁰
66-70	Todos		82601		82618
63-65	Todos		82087		82609

















RIVIERA ESTABILIZADORES DE DIRECCIÓN

		Delantero	Trasero
79-85	Todos	14020











RIVIERA READYMOUNTS

		Delantero	Trasero
98-99	Todos	G56929⁴⁰

ROADMASTER

92-96	Todos		69675 ⁵	81446	34073 ⁸	
	Sedan		69675 ⁵	81446	34073 ⁸		69724	81514	43049 ⁸ 49131 ³⁰
	Wagon		69675 ⁵	81446	34073 ⁸		69604	81492	43060 ⁸ 49152 ³⁰
91	Todos		34073 ⁸	
	Wagon		69675 ⁵	81446	34073 ⁸		69604	81492	43060 ⁸ 49152 ³⁰
58	Exc. Suspensión de Aire		81270		82156
57	Exc. Suspensión de Aire			82156
56	Exc. Suspensión de Aire		82087		81147

SKYHAWK

87-89	Izquierdo		G56706	142762 ⁶⁵		69749	81530	141974 ⁵³	49371 ⁷
	Derecho		G56705	142762 ⁶⁵		69749	81530	141974 ⁵³	49371 ⁷
84-86	Izquierdo Struts de EO no reconstruibles		G56706	142762 ⁶⁵		69749	81530	141974 ⁵³	49371 ⁷
	Derecho Struts de EO no reconstruibles		G56705	142762 ⁶⁵		69749	81530	141974 ⁵³	49371 ⁷
	Struts Reconstruibles de EO		G44451 ⁹⁸	142762 ⁶⁵		69749	81530	141974 ⁵³	49371 ⁷

5 Use el kit 140719 para reemplazar partes del EO de montaje inferior cuando los pernos se rompan o los tornillos autoroscantes no se puedan utilizar más.

8 Paquetes en pares

30 Para Vehículos GM equipados con sistemas de nivelación de fábrica, vea Ref. A.

53 Montaje de Strut. Es probable reutilizar algunas partes del E.O.

65 El Kit de Montaje incluye: Asiento de Resorte Superior con Aislador. Es probable reutilizar algunas partes del E.O.

Texto en Negritas - Número de Parte Nuevo / Futuro

7 Paquetes en pares; kit de mangueras de aire incluido

9 Vea Ref.D para los procedimientos de reemplazo de una Susp. Elect. Ajust. con un producto no ajust.

40 Strut ReadyMount. Ensamble Completo

54 Kit con Montaje y Rodamiento. Es probable que reutilizar algunas partes del E.O.

98 Nota: El nivel de dificultad para instalar este producto es moderadamente alto. Por favor revise las instrucciones cuidadosamente antes de comenzar.

AMORTIGUADORES Y STRUTS

Año	Notas de Aplicación	From					Rear				
		Ultra	ProGuard\ Guardian	LTV\ Max Control	Protector de Strut\ Bases de Strut	HiJacker\ Soporte\ Hidráulico	Ultra	ProGuard\ Guardian	LTV\ Max Control	Protector de Strut\ Bases de Strut	HiJacker\ Soporte\ Hidráulico

BUICK

BUICK

SKYHAWK (cont)

82-86	Todos	142762 ⁶⁵	69749	81530	141974 ⁵³	49371 ⁷
75-80	Todos	82129	81438

SKYLARK

95-98	Izquierdo	G56720	142227 ⁵⁸	69407 ⁹	81790	141974 ⁵³	49614 ⁷
	Derecho	G56719	142227 ⁵⁸	69407 ⁹	81790	141974 ⁵³	49614 ⁷
92-94	Todos	69749	81530	141974 ⁵³	49371 ⁷
	Exc. FE3 y Control de Manejo Electrónico	142227 ⁵⁸	69749	81530	141974 ⁵³	49371 ⁷
	Izquierdo Exc. FE3 y Control de Manejo Electrónico	G56720 ⁹	69749	81530	141974 ⁵³	49371 ⁷
	Izquierdo Suspensión FE3	G56723	69749	81530	141974 ⁵³	49371 ⁷
	Derecho Exc. FE3 y Control de Manejo Electrónico	G56719 ⁹	69749	81530	141974 ⁵³	49371 ⁷
	Derecho Suspensión FE3	G56724	69749	81530	141974 ⁵³	49371 ⁷
86-91	Todos	142762 ⁶⁵	69749	81530	141974 ⁵³	49371 ⁷
	Izquierdo Struts de EO no reconstruibles	G56706	142762 ⁶⁵	69749	81530	141974 ⁵³	49371 ⁷
	Derecho Struts de EO no reconstruibles	G56705	142762 ⁶⁵	69749	81530	141974 ⁵³	49371 ⁷
	Struts Reconstruibles de EO	G44451 ⁹⁸	142762 ⁶⁵	69749	81530	141974 ⁵³	49371 ⁷
80-85	Todos	42517	
85	Todos	G55514	142223 ⁵³ 142749 ⁶⁵	69723	81517	141974 ⁵³	49370 ³⁰ 42517
84	Todos	142223 ⁵³	69723	81517	141974 ⁵³	49370 ³⁰ 42517
	Exc. Suspensión HD	G55505	42517
	Suspensión HD	G55514	42517
80-83	Todos	G55505	142223 ⁵³	69723	81517	49370 ³⁰ 42517
75-79	Todos	69600	81494	34051 ⁸	82093	49193 ⁷
69-72	Todos	69600	81494	34051 ⁸	69604	81492	43060 ⁸ 49152 ³⁰
68	Todos	69600	81494	69604	81492	43060 ⁸ 49152 ³⁰
	Suspensión HD Exc. Sportwagon	69600	81494	34051 ⁸	69604	81492	43060 ⁸ 49152 ³⁰
64-67	Exc. Suspensión HD	69724	81514	43049 ⁸ 49131 ³⁰
	Suspensión HD Exc. Sportwagon	82138	69604	81492	43060 ⁸ 49152 ³⁰
61-63	Todos	81495

7 Paquetes en pares; kit de mangueras de aire incluido

9 Vea Ref.D para los procedimientos de reemplazo de una Susp. Elect. Ajust. con un producto no ajust.

53 Montaje de Strut. Es probable reutilizar algunas partes del E.O.

65 El Kit de Montaje incluye: Asiento de Resorte Superior con Aislador. Es probable reutilizar algunas partes del E.O.



8 Paquetes en pares

30 Para Vehículos GM equipados con sistemas de nivelación de fábrica, vea Ref. A.

58 El Kit de Montaje incluye: Rodamiento de Suspensión. Es probable reutilizar algunas partes del E.O.

98 Nota: El nivel de dificultad para instalar este producto es moderadamente alto. Por favor revise las instrucciones cuidadosamente antes de comenzar.

AMORTIGUADORES Y STRUTS

Año	Notas de Aplicación	Front					Rear				
			Ultra	ProGuard\ Guardian	LTV\ Max Control	Protector de Strut\ Bases de Strut	HiJacker\ Soporte\ Hidráulico		Ultra	ProGuard\ Guardian	LTV\ Max Control









BUICK

BUICK















SKYLARK READYMOUNTS

		Delantero	Trasero
95-98	Izquierdo	G56917 ⁴⁰
	Derecho	G56916 ⁴⁰
92-94	Izquierdo Exc. FE3 y Control de Manejo Electrónico	G56919 ⁴
85	Todos	G56908 ⁴⁰
84	Suspensión HD	G56908 ⁴⁰







SOMERSET / SOMERSET REGAL

85-87	Todos		142762 ⁶⁵		69749	81530	141974 ⁵³	49371 ⁷
	Izquierdo Struts de EO no reconstruibles		G56706	142762 ⁶⁵		69749	81530	141974 ⁵³	49371 ⁷
	Derecho Struts de EO no reconstruibles		G56705	142762 ⁶⁵		69749	81530	141974 ⁵³	49371 ⁷
	Struts Reconstruibles de EO		G44451 ⁸⁸	142762 ⁶⁵		69749	81530	141974 ⁵³	49371 ⁷









SPECIAL

68-69	Todos		69600	81494	34051 ⁸		69604	81492	43060 ⁸ 49152 ³⁰
64-67	Exc. Suspensión HD			69724	81514	43049 ⁸ 49131 ³⁰
	Suspensión HD Exc. Sportwagon		82138		69604	81492	43060 ⁸ 49152 ³⁰
61-63	Todos			81495
58	Exc. Suspensión de Aire		81270		82156
57	Exc. Suspensión de Aire			82156
56	Todos		82087		81147











SPORTWAGON

70-72	Todos		69600	81494	34051 ⁸		69604	81492	43060 ⁸ 49152 ³⁰
68-69	Todos		69600	81494	34051 ⁸		69606	81495	49114 ⁷
64-67	Todos		82138		69606	81495	49114 ⁷

SUPER

58	Exc. Suspensión de Aire		81270		82156
57	Exc. Suspensión de Aire			82156
56	Todos			81147
	Exc. Suspensión de Aire		82087		81147

TERRAZA

05-07	Exc. Suspensión con Nivelación Neumática		G52025	
	FWD		142526 ⁵⁴	
	FWD, Exc. Suspensión con Nivelación Neumática			G63776
	FWD, Suspensión con Nivelación Neumática; Exc. Suspensión Trasera Independiente			49230 ⁷
05-06	AWD		G55948	

4 Número de futuro, las cantidades disponibles Q4 2016.

8 Paquetes en pares

40 Strut ReadyMount. Ensemble Completo

54 Kit con Montaje y Rodamiento. Es probable que reutilizar algunas partes del E.O.

98 Nota: El nivel de dificultad para instalar este producto es moderadamente alto. Por favor revise las instrucciones cuidadosamente antes de comenzar.

7 Paquetes en pares; kit de mangueras de aire incluido

30 Para Vehículos GM equipados con sistemas de nivelación de fábrica, vea Ref. A.

53 Montaje de Strut. Es probable reutilizar algunas partes del E.O.

65 El Kit de Montaje incluye: Asiento de Resorte Superior con Aislador. Es probable reutilizar algunas partes del E.O.

Texto en Negritas - Número de Parte Nuevo / Futuro

AMORTIGUADORES Y STRUTS

Año	Notas de Aplicación	Front					Rear				
		Ultra	ProGuard\ Guardian	LTV\ Max Control	Protector de Strut\ Bases de Strut	HiJacker\ Soporte\ Hidráulico	Ultra	ProGuard\ Guardian	LTV\ Max Control	Protector de Strut\ Bases de Strut	HiJacker\ Soporte\ Hidráulico

BUICK

BUICK

TERRAZA READYMOUNTS

		Delantero	Trasero
05-07	FWD	G57142 ³

VERANO

12-16	Izquierdo	G52432
	Derecho	G52433

WILDCAT

65-70	Todos	82601	82602
63-64	Todos	82087	82609

CADILLAC

CADILLAC

60 SPECIAL

93	Todos	G56718 ⁹	142226 ⁵⁴ 142227 ⁵⁸ 142751 ⁶⁵	142132 ⁵³
	Coil(RearSpringType) Reemplazo Tipo Convencional para Susp. Trasera Asistida por Aire	G56718 ⁹	142226 ⁵⁴ 142227 ⁵⁸ 142751 ⁶⁵	G56707 ⁹	142132 ⁵³

60 SPECIAL READYMOUNTS

		Delantero	Trasero
93	Todos	G56909 ¹⁰
	Equipamiento Estándar para Suspensión Trasera Asistida por Aire	G56909 ¹⁰	G56906 ⁴²
	Coil(RearSpringType) Reemplazo Tipo Convencional para Susp. Trasera Asistida por Aire	G56909 ¹⁰	G56726 ⁴²

ALLANTE

87-93	Todos	142227 ⁵⁸
89-92	Exc. Suspensión Electrónica Ajustable	G56717	142297 ⁵⁴ 142227 ⁵⁸	142405 ⁵³
87-88	Exc. Suspensión Electrónica Ajustable	G56703	142297 ⁵⁴ 142227 ⁵⁸	142405 ⁵³

ATS

13-16	AWD, Izquierdo	G52622 ²
	AWD, Derecho	G52623 ²

BROUGHAM

91-92	Todos	69675 ⁵	81446	142226 ⁵⁴	34073 ⁸	69724	81514	43049 ⁸ 49131 ³⁰
87-90	Todos	69675 ⁵	81446	34073 ⁸	69724	81514	43049 ⁸ 49131 ³⁰

BROUGHAM ESTABILIZADORES DE DIRECCIÓN

		Delantero	Trasero
87-92	Todos	14019

CALAIS

71-76	Todos	82601	82602
69-70	Todos	82601	82610

2 Número de parte futuro

5 Use el kit 140719 para reemplazar partes del EO de montaje inferior cuando los pernos se rompan o los tornillos autoroscantes no se puedan utilizar más.

9 Vea Ref.D para los procedimientos de reemplazo de una Susp. Elect. Ajust. con un producto no ajust.

40 Strut ReadyMount. Ensamble Completo

53 Montaje de Strut. Es probable reutilizar algunas partes del E.O.

58 El Kit de Montaje incluye: Rodamiento de Suspensión. Es probable reutilizar algunas partes del E.O.

Texto en Negritas - Número de Parte Nuevo / Futuro

3 Número de parte futuro



8 Paquetes en pares

30 Para Vehículos GM equipados con sistemas de nivelación de fábrica, vea Ref. A. 42 Strut ReadyMount, no incluye resortes por el diseño del vehículo.

54 Kit con Montaje y Rodamiento. Es probable que reutilizar algunas partes del E.O.

65 El Kit de Montaje incluye: Asiento de Resorte Superior con Aislador. Es probable reutilizar algunas partes del E.O.



AMORTIGUADORES Y STRUTS

Año	Notas de Aplicación	Front					Rear				
			Ultra	ProGuard\ Guardian	LTV\ Max Control	Protector de Strut\ Bases de Strut	HiJacker\ Soporte\ Hidráulico		Ultra	ProGuard\ Guardian	LTV\ Max Control



CADILLAC

CADILLAC















CALAIS (cont)

65-68	Todos		82601		82060
-------	-------	---	-------	-------	-------	-------	-------	---	-------	-------	-------	-------	-------























CATERA

97-01	Todos		G56769	
-------	-------	---	--------	-------	-------	-------	-------	---	-------	-------	-------	-------	-------

CIMARRON

87-88	Izquierdo		G56706	142762 ⁵⁵		69749	81530	141974 ⁵³	49371 ⁷
	Derecho		G56705	142762 ⁵⁵		69749	81530	141974 ⁵³	49371 ⁷
84-86	Todos		142762 ⁵⁵		69749	81530	141974 ⁵³	49371 ⁷
	Izquierdo Struts de EO no reconstruibles		G56706	142762 ⁵⁵		69749	81530	141974 ⁵³	49371 ⁷
	Derecho Struts de EO no reconstruibles		G56705	142762 ⁵⁵		69749	81530	141974 ⁵³	49371 ⁷
	Struts Reconstruibles de EO		G44451 ⁹⁸	142762 ⁵⁵		69749	81530	141974 ⁵³	49371 ⁷
82-83	Todos		142762 ⁵⁵		69749	81530	49371 ⁷

COMMERCIAL CHASSIS

92-96	RWD		69675 ⁵	81446	34073 ⁸		69724	81514	43049 ⁹ 49131 ³⁰
91-93	FWD		G56718 ⁸	142226 ⁵⁴ 142227 ⁵⁸ 142751 ⁵⁵	
	FWD; Reemplazo Convencional para Suspensión Trasera Asistida; Exc. Suspensión Electrónica			G56707 ⁹
	FWD; Suspensión Trasera Asistida; Exc. Suspensión Electrónica Ajustable			G56903	142132 ⁵³
85-90	Todos		G56701	142752 ⁵⁵	
	Equipamiento Estándar para Suspensión Trasera Asistida por Aire		G56701	142752 ⁵⁵		142132 ⁵³
	FWD		G56701	142227 ⁵⁸ 142752 ⁵⁵	
	FWD; Equipamiento Estándar para Suspensión Trasera Asistida por Aire		G56701	142752 ⁵⁵		G56903
	FWD; Reemplazo Convencional para Suspensión Trasera Asistida; Exc. Suspensión Electrónica		G56701	142752 ⁵⁵		G56707 ⁹
77-84	Todos		69675 ⁵	81446	34073 ⁸		69724	81514	43049 ⁹ 49131 ³⁰
75-76	Todos		82601		82125

COMMERCIAL CHASSIS ESTABILIZADORES DE DIRECCIÓN

		Delantero	Trasero
92-96	RWD	14019
77-84	Todos	14019

5 Use el kit 140719 para reemplazar partes del EO de montaje inferior cuando los pernos se rompan o los tornillos autoroscantes no se puedan utilizar más.

8 Paquetes en pares

30 Para Vehículos GM equipados con sistemas de nivelación de fábrica, vea Ref. A.

54 Kit con Montaje y Rodamiento. Es probable que reutilizar algunas partes del E.O.

65 El Kit de Montaje incluye: Asiento de Resorte Superior con Aislador. Es probable reutilizar algunas partes del E.O.

7 Paquetes en pares; kit de mangueras de aire incluido

9 Vea Ref.D para los procedimientos de reemplazo de una Susp. Elect. Ajust. con un producto no ajust.

53 Montaje de Strut. Es probable reutilizar algunas partes del E.O.

58 El Kit de Montaje incluye: Rodamiento de Suspensión. Es probable reutilizar algunas partes del E.O.

98 Nota: El nivel de dificultad para instalar este producto es moderadamente alto. Por favor revise las instrucciones cuidadosamente antes de comenzar.

AMORTIGUADORES Y STRUTS

Año	Notas de Aplicación	Front					Rear				
		Ultra	ProGuard\ Guardian	LTV\ Max Control	Protector de Strut\ Bases de Strut	HiJacker\ Soporte\ Hidráulico	Ultra	ProGuard\ Guardian	LTV\ Max Control	Protector de Strut\ Bases de Strut	HiJacker\ Soporte\ Hidráulico

CADILLAC

CADILLAC

COMMERCIAL CHASSIS READYMOUNTS

		Delantero	Trasero
91-93	FWD	G56909⁴
85-90	Todos	G56914⁴⁰

CTS

12-13	Exc. Suspensión Magnética de Control de Manejo	70031
09-11	Todos	G51901
	Exc. Suspensión Magnética de Control de Manejo	G51901	70031
08	Exc. Suspensión Magnética de Control de Manejo	70031
03-07	Todos	143092 ⁵³
	Exc. Suspensión Magnética de Control de Manejo	G51746	143092 ⁵³	70031

DEVILLE

00-05	Con Entradas de Aire de EO	49255
	Exc. Suspensión Electrónica Ajustable	G56509	142640 ⁵⁴	142647 ⁵³
00-02	Debe usarse con el kit de mangueras incluido	49228 ³⁰
98-99	Exc. Suspensión Electrónica Ajustable	142640 ⁵⁴	G56664
97-99	Control de Manejo Electrónico	142527 ⁵⁴
94-97	Air(RearSpringType) Exc. Suspensión Electrónica Ajustable	G56664
97	Exc. Suspensión Electrónica Ajustable	142640 ⁵⁴
94-95	Izquierdo Exc. Suspensión Electrónica Ajustable	G56669
	Derecho Exc. Suspensión Electrónica Ajustable	G56670
91-93	Todos	142227 ⁵⁸ 142751 ⁶⁵	142132 ⁵³
	Exc. Suspensión Electrónica Ajustable	G56718 ⁹	142226 ⁵⁴ 142227 ⁵⁸ 142751 ⁶⁵	142132 ⁵³
	Air(RearSpringType) Manejo con Comando Computarizado (CCR)	142227 ⁵⁸ 142751 ⁶⁵	G56903	142132 ⁵³
	Air(RearSpringType) Reemplazo Tipo Convencional para Susp. Trasera Asistida por Aire	142227 ⁵⁸ 142751 ⁶⁵	G56707 ⁹	142132 ⁵³
85-90	Todos	G56701	142227 ⁵⁸ 142752 ⁶⁵	142132 ⁵³
	Air(RearSpringType) Equipamiento Estándar para Suspensión Trasera Asistida por Aire	G56701	142227 ⁵⁸ 142752 ⁶⁵	G56903	142132 ⁵³
	Air(RearSpringType) Reemplazo Tipo Convencional para Susp. Trasera Asistida por Aire	G56701	142227 ⁵⁸ 142752 ⁶⁵	G56707 ⁹	142132 ⁵³
77-84	Todos	69675 ⁵	81446	34073 ⁸	69724	81514	43049 ⁸ 49131 ³⁰

4 Número de futuro, las cantidades disponibles Q4 2016.

8 Paquetes en pares

30 Para Vehículos GM equipados con sistemas de nivelación de fábrica, vea Ref. A.

53 Montaje de Strut. Es probable reutilizar algunas partes del E.O.

58 El Kit de Montaje incluye: Rodamiento de Suspensión. Es probable reutilizar algunas partes del E.O.

5 Use el kit 140719 para reemplazar partes del EO de montaje inferior cuando los pernos se rompan o los tornillos autoroscantes no se puedan utilizar más.

9 Vea Ref.D para los procedimientos de reemplazo de una Susp. Elect. Ajust. con un producto no ajust.



40 Strut ReadyMount. Ensamble Completo

54 Kit con Montaje y Rodamiento. Es probable que reutilizar algunas partes del E.O.

65 El Kit de Montaje incluye: Asiento de Resorte Superior con Aislador. Es probable reutilizar algunas partes del E.O.

Texto en Negritas - Número de Parte Nuevo / Futuro



















AMORTIGUADORES Y STRUTS

Año	Notas de Aplicación	Front					Rear				
			Ultra	ProGuard\ Guardian	LTV\ Max Control	Protector de Strut\ Bases de Strut	HiJacker\ Soporte\ Hidráulico		Ultra	ProGuard\ Guardian	LTV\ Max Control

CADILLAC

CADILLAC





DEVILLE (cont)

71-76	Todos		82601		82602
69-70	Todos		82601		82610
65-68	Todos		82601		82060
61-64	Todos		82109		82125
58-60	Todos		82099		82125
56	Todos		82099		82034
55	Todos			82034
54	Todos			82066
53	Todos		82026		82066

























DEVILLE READYMOUNTS

		Delantero		Trasero	
00-05	Exc. Suspensión Electrónica Ajustable	G57051⁴⁰		
91-93	Exc. Suspensión Electrónica Ajustable	G56909⁴		
	Air(RearSpringType) Manejo con Comando Computarizado (CCR)		G56906⁴³	
	Air(RearSpringType) Reemplazo Tipo Convencional para Susp. Trasera Asistida por Aire		G56726 ⁴³	
85-90	Todos	G56914⁴⁰		
	Air(RearSpringType) Equipamiento Estándar para Suspensión Trasera Asistida por Aire	G56914⁴⁰		G56906⁴³	
	Air(RearSpringType) Reemplazo Tipo Convencional para Susp. Trasera Asistida por Aire	G56914⁴⁰		G56726 ⁴³	

DTS

06-11	Todos			49228 ³⁰
	Exc. Suspensión Magnética de Control de Manejo		G52116		49228 ³⁰

ELDORADO

97-02	Control de Manejo Electrónico		142527 ⁵⁴ 142227 ⁵⁸ 142297 ⁵⁴	
	Exc. Control de Manejo Electrónico		142227 ⁵⁸ 142297 ⁵⁴		49254 ⁸
	Izquierdo Exc. Suspensión Electrónica Ajustable		G56775	142227 ⁵⁸ 142297 ⁵⁴	
	Derecho Exc. Suspensión Electrónica Ajustable		G56776	142227 ⁵⁸ 142297 ⁵⁴	
94-02	Todos		142227 ⁵⁸ 142297 ⁵⁴	
91-93	Todos		G56717 ⁹	142227 ⁵⁸ 142297 ⁵⁴		G56704 ⁹	142405 ⁵³
90	Todos		G56717 ⁹	142297 ⁵⁴		G56704 ⁹	142405 ⁵³
87-89	Todos		G56703	142297 ⁵⁴		G56704 ⁹	142405 ⁵³
86	Todos		G56703	142298 ⁵⁴		G56704 ⁹	142405 ⁵³
79-85	Todos		69706	81445		49345 ³⁰
71-78	Todos		82010	
68-70	Montado Verticalmente		82010		82040	49122 ⁷

4 Número de futuro, las cantidades disponibles Q4 2016.

8 Paquetes en pares

30 Para Vehículos GM equipados con sistemas de nivelación de fábrica, vea Ref. A.
43 Strut ReadyMount, no incluye resortes por el diseño del vehículo. Consulte la Ref. D para el procedimiento de reemplazo en una Susp. Elec. Ajustable con un producto no ajustable

54 Kit con Montaje y Rodamiento. Es probable que reutilizar algunas partes del E.O.

Texto en Negritas - Número de Parte Nuevo / Futuro

7 Paquetes en pares; kit de mangueras de aire incluido



9 Vea Ref.D para los procedimientos de reemplazo de una Susp. Elect. Ajust. con un producto no ajust.

40 Strut ReadyMount. Ensamble Completo

53 Montaje de Strut. Es probable reutilizar algunas partes del E.O.

58 El Kit de Montaje incluye: Rodamiento de Suspensión. Es probable reutilizar algunas partes del E.O.

AMORTIGUADORES Y STRUTS

Año	Notas de Aplicación										
		Ultra	ProGuard\ Guardian	LTV\ Max Control	Protector de Strut\ Bases de Strut	HiJacker\ Soporte\ Hidráulico	Ultra	ProGuard\ Guardian	LTV\ Max Control	Protector de Strut\ Bases de Strut	HiJacker\ Soporte\ Hidráulico

CADILLAC

CADILLAC

ELDORADO (cont)

67	Montado Verticalmente	○	82010	○	82034
----	-----------------------	---	------	-------	------	------	------	---	------	-------	------	------	------

ELDORADO ESTABILIZADORES DE DIRECCIÓN

										Delantero	Trasero		
79-85	Todos											14020
67-78	Todos											14010

ESCALADE

11-13	Todos	○	○	G63866
	Exc. Control de Manejo Electrónico	↓	G51891	143316 ⁵³	○	G63866
07-10	Exc. Control de Manejo Electrónico	↓	G51891	143316 ⁵³	○	G63866	61675	58930 77953
02-10	Todos	○	○	G63866	58930 77953
02-06	Exc. Control de Manejo Electrónico	↓	G63803	77803	○	G63866	61675	58930 77953
99-00	Todos	○	G63609	61542 81726	58609 77609	○	G63638	61565 81789	58638 77638	43180 ⁹ 49231 ⁷

ESCALADE ESV

11-13	Exc. Control de Manejo Electrónico	↓	G51891	143316 ⁵³	○
07-10	Exc. Control de Manejo Electrónico	↓	G51891	143316 ⁵³	○	61675
03-06	Exc. Control de Manejo Electrónico	↓	G63803	77803	○	61675

ESCALADE EXT

11-13	Exc. Control de Manejo Electrónico	↓	G51891	143316 ⁵³	○
07-10	Exc. Control de Manejo Electrónico	↓	G51891	143316 ⁵³	○	61675
02-06	Exc. Control de Manejo Electrónico	↓	G63803	77803	○	61675

FLEETWOOD

94-96	Todos	○	34073 ⁸	○
	RWD	○	69675 ⁵	81446	34073 ⁸	○	69724	81514	43049 ⁹ 49131 ³⁰
93	Todos	↓	G56718 ⁹	142226 ⁵⁴ 142227 ⁵⁸ 142751 ⁶⁵	34073 ⁸	○
	Exc. Suspensión Electrónica Ajustable	↓	G56718 ⁹	142226 ⁵⁴ 142227 ⁵⁸ 142751 ⁶⁵	34073 ⁸	↓	142132 ⁵³
	Reemplazo Tipo Convencional para Susp. Trasera Asistida por Aire	↓	G56718 ⁹	142226 ⁵⁴ 142227 ⁵⁸ 142751 ⁶⁵	34073 ⁸	↓	G56707 ⁹
	Suspensión Trasera Asistida por Aire; Exc. Suspensión Electrónica Ajustable	↓	G56718 ⁹	142226 ⁵⁴ 142227 ⁵⁸ 142751 ⁶⁵	34073 ⁸	↓	G56903
	RWD	○	69675 ⁵	81446	142226 ⁵⁴ 142227 ⁵⁸ 142751 ⁶⁵	34073 ⁸	○	69724	81514	43049 ⁹ 49131 ³⁰
91-92	Todos	↓	G56718 ⁹	142226 ⁵⁴ 142227 ⁵⁸ 142751 ⁶⁵	○

5 Use el kit 140719 para reemplazar partes del EO de montaje inferior cuando los pernos se rompan o los tornillos autoroscantes no se puedan utilizar más.

8 Paquetes en pares

30 Para Vehículos GM equipados con sistemas de nivelación de fábrica, vea Ref. A.

54 Kit con Montaje y Rodamiento. Es probable que reutilizar algunas partes del E.O.

65 El Kit de Montaje incluye: Asiento de Resorte Superior con Aislador. Es probable reutilizar algunas partes del E.O.

7 Paquetes en pares; kit de mangueras de aire incluido

9 Vea Ref.D para los procedimientos de reemplazo de una Susp. Elect. Ajust. con un producto no ajust.

53 Montaje de Strut. Es probable reutilizar algunas partes del E.O.

58 El Kit de Montaje incluye: Rodamiento de Suspensión. Es probable reutilizar algunas partes del E.O.

AMORTIGUADORES Y STRUTS

Año	Notas de Aplicación										
		Ultra	ProGuard\ Guardian	LTV\ Max Control	Protector de Strut\ Bases de Strut	HiJacker\ Soporte\ Hidráulico	Ultra	ProGuard\ Guardian	LTV\ Max Control	Protector de Strut\ Bases de Strut	HiJacker\ Soporte\ Hidráulico

CADILLAC

CADILLAC

FLEETWOOD (cont)

91-92	Exc. Suspensión Electrónica Ajustable		G56718 ⁸	142226 ⁵⁴ 142227 ⁵⁸ 142751 ⁶⁵	142132 ⁵³
	Reemplazo Tipo Convencional para Susp. Trasera Asistida por Aire		G56718 ⁸	142226 ⁵⁴ 142227 ⁵⁸ 142751 ⁶⁵		G56707 ⁹
	Suspensión Trasera Asistida por Aire; Exc. Suspensión Electrónica Ajustable		G56718 ⁸	142226 ⁵⁴ 142227 ⁵⁸ 142751 ⁶⁵		G56903
87-90	Todos		G56701	142227 ⁵⁸ 142752 ⁶⁵
	Equipamiento Estándar para Suspensión Trasera Asistida por Aire		G56701	142227 ⁵⁸ 142752 ⁶⁵		G56903	142132 ⁵³
	Reemplazo Tipo Convencional para Susp. Trasera Asistida por Aire		G56701	142227 ⁵⁸ 142752 ⁶⁵		G56707 ⁹
86	Todos		G56701	142227 ⁶⁵
	Equipamiento Estándar para Suspensión Trasera Asistida por Aire		G56701	142227 ⁶⁵		G56903
	Exc. Suspensión Electrónica Ajustable		G56701	142227 ⁶⁵	142132 ⁵³
	Reemplazo Tipo Convencional para Susp. Trasera Asistida por Aire		G56701	142227 ⁶⁵		G56707 ⁹
	RWD		69675 ⁵	81446	142227 ⁶⁵	34073 ⁸		69724	81514	43049 ⁸ 49131 ³⁰
85	Todos		G56701	142227 ⁵⁸
	Equipamiento Estándar para Suspensión Trasera Asistida por Aire		G56701	142227 ⁵⁸		G56903
	Exc. Suspensión Electrónica Ajustable		G56701	142227 ⁵⁸	142132 ⁵³
	Reemplazo Tipo Convencional para Susp. Trasera Asistida por Aire		G56701	142227 ⁵⁸		G56707 ⁹
	RWD		69675 ⁵	81446	142227 ⁵⁸	34073 ⁸		69724	81514	43049 ⁸ 49131 ³⁰
77-84	RWD		69675 ⁵	81446	34073 ⁸		69724	81514	43049 ⁸ 49131 ³⁰
71-76	Todos		82601	82602
69-70	Todos		82601	82610
65-68	Todos		82601	82060

FLEETWOOD / 60 SERIES / 70 SERIES

61-64	Todos		82109	82125
57-60	Todos		82099	82125
56	Todos		82099	82034
55	Todos		82034
54	Todos		82066
52-53	Todos		82026	82066
50-51	Todos		82026	82060

5 Use el kit 140719 para reemplazar partes del EO de montaje inferior cuando los pernos se rompan o los tornillos autoroscantes no se puedan utilizar más.

9 Vea Ref.D para los procedimientos de reemplazo de una Susp. Elect. Ajust. con un producto no ajust.

53 Montaje de Strut. Es probable reutilizar algunas partes del E.O.

58 El Kit de Montaje incluye: Rodamiento de Suspensión. Es probable reutilizar algunas partes del E.O.



8 Paquetes en pares

30 Para Vehículos GM equipados con sistemas de nivelación de fábrica, vea Ref. A.

54 Kit con Montaje y Rodamiento. Es probable que reutilizar algunas partes del E.O.

65 El Kit de Montaje incluye: Asiento de Resorte Superior con Aislador. Es probable reutilizar algunas partes del E.O.

AMORTIGUADORES Y STRUTS

Año	Notas de Aplicación	From 					Rear 				
		Ultra	ProGuard\ Guardian	LTV\ Max Control	Protector de Strut\ Bases de Strut	HiJacker\ Soporte\ Hidráulico	Ultra	ProGuard\ Guardian	LTV\ Max Control	Protector de Strut\ Bases de Strut	HiJacker\ Soporte\ Hidráulico

CADILLAC

CADILLAC

FLEETWOOD ESTABILIZADORES DE DIRECCIÓN

		Delantero	Trasero
85-96	RWD	14019

FLEETWOOD READYMOUNTS

		Delantero	Trasero
91-93	Todos	G56909⁴
	Equipamiento Estándar para Suspensión Trasera Asistida por Aire	G56909⁴	G56906⁴³
	Reemplazo Tipo Convencional para Susp. Trasera Asistida por Aire	G56909⁴	G56726 ⁴³
85-90	Todos	G56914⁴⁰
	Equipamiento Estándar para Suspensión Trasera Asistida por Aire	G56914⁴⁰	G56906⁴³
	Reemplazo Tipo Convencional para Susp. Trasera Asistida por Aire	G56914⁴⁰	G56726 ⁴³

SEVILLE

98-04	Todos	142524 ⁵⁸
	Con Entradas de Aire de EO	142524 ⁵⁸	49255
	Exc. Suspensión Electrónica Ajustable	G56509	142640 ⁵⁴ 142524 ⁵⁸	142647 ⁵³
	sin conexión de aire OE Estilo	142524 ⁵⁸	49228 ³⁰
94-97	Todos	142227 ⁵⁸ 142527 ⁵⁴
93	Todos	142227 ⁵⁸ 142527 ⁵⁴	142405 ⁵³
	Suspensión c/ Sensor de Velocidad (SSS) o Manejo con Comando Computarizado (CCR); No ajustable	G56717 ⁹	142227 ⁵⁸ 142527 ⁵⁴	G56704 ⁹	142405 ⁵³
90-92	Todos	142227 ⁵⁸ 142297 ⁵⁴	142405 ⁵³
	Suspensión c/ Sensor de Velocidad (SSS) o Manejo con Comando Computarizado (CCR); No ajustable	G56717 ⁹	142227 ⁵⁸ 142297 ⁵⁴	G56704 ⁹	142405 ⁵³
87-89	Todos	G56703	142227 ⁵⁸ 142297 ⁵⁴	G56704 ⁹	142405 ⁵³
86	Todos	G56703	142298 ⁵⁴	G56704 ⁹	142405 ⁵³
80-85	Todos	69706	81445	49345 ³⁰
76-79	Todos	69600	81494	34051 ⁸

SEVILLE ESTABILIZADORES DE DIRECCIÓN

		Delantero	Trasero
80-85	Todos	14020
76-79	Todos	14018

SEVILLE READYMOUNTS

		Delantero	Trasero
98-04	Exc. Suspensión Electrónica Ajustable	G57051⁴⁰

CHEVROLET

CHEVROLET

400SS PICKUP

98	5.7L 8Cyl (350) MFI	61543
92-96	5.7L 8Cyl (350) MFI	G63489	61544 81668	61543
								81667

4 Número de futuro, las cantidades disponibles Q4 2016.

9 Vea Ref.D para los procedimientos de reemplazo de una Susp. Elect. Ajust. con un producto no ajust.

40 Strut ReadyMount. Ensamble Completo

53 Montaje de Strut. Es probable reutilizar algunas partes del E.O.

58 El Kit de Montaje incluye: Rodamiento de Suspensión. Es probable reutilizar algunas partes del E.O.





Texto en Negritas - Número de Parte Nuevo / Futuro

8 Paquetes en pares

30 Para Vehículos GM equipados con sistemas de nivelación de fábrica, vea Ref. A. 43 Strut ReadyMount, no incluye resortes por el diseño del vehículo. Consulte la Ref. D para el procedimiento de reemplazo en una Susp. Elec. Ajustable con un producto no ajustable

54 Kit con Montaje y Rodamiento. Es probable que reutilizar algunas partes del E.O.



AMORTIGUADORES Y STRUTS

Año	Notas de Aplicación										
			Ultra	ProGuard\ Guardian	LTV\ Max Control	Protector de Strut\ Bases de Strut	HiJacker\ Soporte\ Hidráulico		Ultra	ProGuard\ Guardian	LTV\ Max Control





CHEVROLET

CHEVROLET





ASTRA

00-06	Izquierdo		G56649
	Derecho		G56650

ASTRO

90-05	Todos	
	AWD		G63818	61542 81726	58609 77609	43161 ⁸ 49215 ⁷
	RWD		G63375 ⁵	61555 81713 ⁵	77375	43161 ⁸ 49215 ⁷
85-89	RWD		G63375 ⁵	61555 81713 ⁵	77375	43161 ⁸ 49215 ⁷

AVALANCHE 1500

12-13	Exc. Suspensión Z55 o ZW7		G51891
07-13	Exc. Control de Manejo Electrónico		143316 ⁵³
11	Exc. Suspensión Z55 o ZW7		G51891
07-10	Exc. Suspensión Z55 o ZW7	
02-06	Exc. Control de Manejo Electrónico		G63803	61643 81922	58803 77803









AVALANCHE 1500 READYMOUNTS

								Delantero		Trasero			
07-13	Exc. Suspensión Z55 o ZW7									G57125 ⁴⁰		

AVALANCHE 2500

02-06	Exc. Control de Manejo Electrónico		G63817	61663 81925	58817 77817
-------	------------------------------------	---	--------	----------------	----------------	------	------	------	------	------	------	------

AVEO

13-15	Izquierdo		G56886
	Derecho		G56887
12	Izquierdo		G56886	143239 ⁵³
	Derecho		G56887	143239 ⁵³
10-11	Izquierdo		G56886	143239 ⁵³	143375 ⁵³
	Derecho		G56887	143239 ⁵³	143375 ⁵³
04-09	Todos		143309
	Izquierdo		G56886	143239 ⁵³ 143309	143375 ⁵³
	Derecho		G56887	143239 ⁵³ 143309	143375 ⁵³

AVEO READYMOUNTS

								Delantero		Trasero			
12-15	Izquierdo									G57130		
	Derecho									G57131		
04-11	Izquierdo									G57130 ⁴⁰		
	Derecho									G57131 ⁴⁰		

5 Use el kit 140719 para reemplazar partes del EO de montaje inferior cuando los pernos se rompan o los tornillos autoroscantes no se puedan utilizar más. 7 Paquetes en pares; kit de mangueras de aire incluido

8 Paquetes en pares

53 Montaje de Strut. Es probable reutilizar algunas partes del E.O.

40 Strut ReadyMount. Ensamble Completo

Texto en Negritas - Número de Parte Nuevo / Futuro

AMORTIGUADORES Y STRUTS

Año	Notas de Aplicación	From					Rear				
		Ultra	ProGuard\ Guardian	LTV\ Max Control	Protector de Strut\ Bases de Strut	HiJacker\ Soporte\ Hidráulico	Ultra	ProGuard\ Guardian	LTV\ Max Control	Protector de Strut\ Bases de Strut	HiJacker\ Soporte\ Hidráulico

CHEVROLET BEL AIR

CHEVROLET

81	Todos	81446	77375	34073 ⁸	69724	81514	43049 ⁸ 49131 ³⁰
	Sedan Exc. Modelos Policía y Taxi	69675 ⁵	81446	77375	34073 ⁸	69724	81514	43049 ⁸ 49131 ³⁰
	Sedan Modelos Policía y Taxi	G63375 ⁵	61555 81446	77375	34073 ⁸	69724	81514	43049 ⁸ 49131 ³⁰
75	Todos	77375	69724	81514
	Sedan	81446	77375	34073 ⁸	69724	81514	43049 ⁸ 49131 ³⁰
	Sedan Exc. Modelos Policía y Taxi	69675 ⁵	77375	69724	81514
	Sedan Modelos Policía y Taxi	G63375 ⁵	61555	77375	69724	81514
	Wagon	81713 ⁵	77375	69724	81514
71-74	Todos	77375	34073 ⁸	69724	81514	43049 ⁸ 49131 ³⁰
	Sedan	81446	77375	34073 ⁸	69724	81514	43049 ⁸ 49131 ³⁰
	Sedan Exc. Modelos Policía y Taxi	69675 ⁵	77375	34073 ⁸	69724	81514	43049 ⁸ 49131 ³⁰
	Sedan Modelos Policía y Taxi	G63375 ⁵	61555	77375	34073 ⁸	69724	81514	43049 ⁸ 49131 ³⁰
	Wagon	81713 ⁵	77375	34073 ⁸	69724	81514	43049 ⁸ 49131 ³⁰
65-70	Todos	69675 ⁵	81446	34073 ⁸	69724	81514	43049 ⁸ 49131 ³⁰
58-64	Todos	82118	82051
55-57	Todos	69625	82099	82066
50-54	Todos	82026	82155

BERETTA

95-96	Izquierdo	G56720	142227 ⁵⁸	69407 ⁹	81790	141974 ⁵³	49614 ⁷
	Derecho	G56719	142227 ⁵⁸	69407 ⁹	81790	141974 ⁵³	49614 ⁷
92-94	Todos	142227 ⁵⁸
	Base, Izquierdo Exc. Suspensión FE7	G56720 ⁹	142227 ⁵⁸	69749	81530	141974 ⁵³	49371 ⁷
	Base, Derecho Exc. Suspensión FE7	G56719 ⁹	142227 ⁵⁸	69749	81530	141974 ⁵³	49371 ⁷
94	Z26, Izquierdo Suspensión FE7	G56723	142227 ⁵⁸
	Z26, Derecho Suspensión FE7	G56724	142227 ⁵⁸
92-93	GT, GTZ, Izquierdo Suspensión FE7	G56723	142227 ⁵⁸
	GT, GTZ, Derecho Suspensión FE7	G56724	142227 ⁵⁸
87-91	Izquierdo	G56706	142762 ⁶⁵	69749	81530	141974 ⁵³	49371 ⁷
	Derecho	G56705	142762 ⁶⁵	69749	81530	141974 ⁵³	49371 ⁷

5 Use el kit 140719 para reemplazar partes del EO de montaje inferior cuando los pernos se rompan o los tornillos autoroscantes no se puedan utilizar más.

8 Paquetes en pares

30 Para Vehículos GM equipados con sistemas de nivelación de fábrica, vea Ref. A.

58 El Kit de Montaje incluye: Rodamiento de Suspensión. Es probable reutilizar algunas partes del E.O.



7 Paquetes en pares; kit de mangueras de aire incluido

9 Vea Ref.D para los procedimientos de reemplazo de una Susp. Elect. Ajust. con un producto no ajust.

53 Montaje de Strut. Es probable reutilizar algunas partes del E.O.

65 El Kit de Montaje incluye: Asiento de Resorte Superior con Aislador. Es probable reutilizar algunas partes del E.O.

AMORTIGUADORES Y STRUTS

Año	Notas de Aplicación										
		Ultra	ProGuard\ Guardian	LTV\ Max Control	Protector de Strut\ Bases de Strut	HiJacker\ Soporte\ Hidráulico	Ultra	ProGuard\ Guardian	LTV\ Max Control	Protector de Strut\ Bases de Strut	HiJacker\ Soporte\ Hidráulico

CHEVROLET

CHEVROLET

BERETTA READYMOUNTS

		Delantero	Trasero
95-96	Izquierdo	G56917 ⁴⁰
	Derecho	G56916 ⁴⁰
92-94	Exc. Suspensión FE7 Izquierdo	G56919 ⁴
87-91	Izquierdo	G56921 ⁴⁰
	Derecho	G56920 ⁴⁰

BISCAYNE

71-72	Todos	I/O 69675 ⁵	77375	34073 ⁸	O/O 69724	81514	43049 ⁸ 49131 ³⁰
	Exc. Modelos Policía y Taxi	I/O 69675 ⁵	81446	77375	34073 ⁸	O/O 69724	81514	43049 ⁸ 49131 ³⁰
	Modelos Policía y Taxi	I/O 69675 ⁵	61555 81713 ⁵	77375	34073 ⁸	O/O 69724	81514	43049 ⁸ 49131 ³⁰
65-70	Todos	I/O	34073 ⁸	O/O 69724	81514	43049 ⁸ 49131 ³⁰
	Exc. Modelos Policía y Taxi	I/O	81446	34073 ⁸	O/O 69724	81514	43049 ⁸ 49131 ³⁰
58-64	Todos	I/O	82118	O/O	82051

BLAZER

73-91	Todos	I/O	70165
-------	-------	------	------	------	------	------	-----------	------	------	------	-------

BLAZER 2WD

95-05	RWD; Modelo S, Exc. Xtreme Models	I/O G63421	61504 81750	58421 77421	34051 ⁸	O/O G63422	61528 81482	58422 77422	43162 ⁸ 49213 ⁷
87-91	Automóvil Grande; Exc. Suspensión Quad y Kit de Levantamiento	O/O G63349	61524 81164	58349 ⁵⁰ 77349	43111 ⁸ 49155 ⁷
73-86	Exc. Kit de Levantamiento	O/O G63349	61524 81164	58349 77349	43111 ⁸ 49155 ⁷
75-84	RWD	O/O G63355	61525 81039	58355 77355	34036 ⁸
73-74	4WD; Con Kit de Levantamiento de 4"; Exc. Suspensión Quad	58437 ⁵⁰
69-74	RWD	O/O G63355	61525 81039	58355 77355	34036 ⁸
69-72	Resorte Trasero	O/O	82003	49107 ⁷
	Resorte Trasero de Hojas Múltiples	O/O	82006	49162 ⁷
	RWD; Resorte Trasero	O/O	43062 ⁸
	RWD; Resorte Trasero de Hojas Múltiples	O/O	43093 ⁸
	RWD	O/O G63306

BLAZER 4WD

95-05	4WD; Modelo S; Exc. ZR2	O/O G63423	61531 81516	58423 77423	O/O G63422	61528 81482	58422 77422	43162 ⁸ 49213 ⁷
92-94	4WD, Automóvil Grande	O/O G63609	61542 81726	58609 77609	O/O G63638 ⁵⁰	61565 81789	58638 77638	43180 ⁸ 49231 ⁷
	4WD, Full Size	O/O	77638
87-91	Automóvil Grande; Exc. Suspensión Quad y Kit de Levantamiento	O/O G63349	61524 81164	58349 ⁵⁰ 77349	43111 ⁸ 49155 ⁷
	4WD, Automóvil Grande; Exc. Suspensión Quad y Kit de Levantamiento	O/O G63347	58347 ⁵⁰	43107 ⁸
	4WD, Automóvil Grande; Suspensión Quad Amortiguador Corto; Exc. Kit de Levantamiento	O/O G63908 ⁸	61516 ⁸ 81113 ⁸	58908 ⁸

4 Número de futuro, las cantidades disponibles Q4 2016.

6 Se recomienda que cuando se reemplacen amortiguadores "quad", los 4 sean de la misma serie.

8 Paquetes en pares

40 Strut ReadyMount. Ensamble Completo

Texto en Negritas - Número de Parte Nuevo / Futuro

5 Use el kit 140719 para reemplazar partes del EO de montaje inferior cuando los pernos se rompan o los tornillos autoroscantes no se puedan utilizar más.

7 Paquetes en pares; kit de mangueras de aire incluido

30 Para Vehículos GM equipados con sistemas de nivelación de fábrica, vea Ref. A.

50 Para proteger la barra del pistón, se recomienda utilizar el kit Bellows No.141242.

AMORTIGUADORES Y STRUTS

Año	Notas de Aplicación	Front					Rear				
		Ultra	ProGuard\ Guardian	LTV\ Max Control	Protector de Strut\ Bases de Strut	HiJacker\ Soporte\ Hidráulico	Ultra	ProGuard\ Guardian	LTV\ Max Control	Protector de Strut\ Bases de Strut	HiJacker\ Soporte\ Hidráulico

CHEVROLET

CHEVROLET

BLAZER 4WD (cont)

87-91	4WD, Automóvil Grande; Suspensión Quad Amortiguador Largo; Exc. Kit de Levantamiento	○ ○	G63906 ⁶	61522 ⁶ 81496 ⁶	58906 ⁶	
91	4WD, Automóvil Grande; Kit de Levantamiento de 4"; Exc. Suspensión Quad	○ ○	G63437 ⁵⁰	58437 ⁵⁰	
87-90	4WD, Automóvil Grande; Kit de Levantamiento de 4"; Exc. Suspensión Quad	○ ○	G63437 ⁵⁰	58437 ⁵⁰	○ ○	G63438 ⁵⁰	58438 ⁵⁰
81-86	4WD, Exc. Suspensión Quad y Kit de Levantamiento	○ ○	G63347	58347 ⁵⁰	
	4WD, Suspensión Quad Amortiguador Corto; Exc. Kit de Levantamiento	○ ○	G63908 ⁶	61516 81113 ⁶	58908 ⁶	
	4WD, Suspensión Quad Amortiguador Largo; Exc. Kit de Levantamiento	○ ○	G63906 ⁶	61522 ⁶ 81496 ⁶	58906 ⁶	
75-86	4WD, Con Kit de Levantamiento de 4"; Exc. Suspensión Quad	○ ○	G63437 ⁵⁰	58437 ⁵⁰	○ ○	G63438 ⁵⁰	58438 ⁵⁰
73-86	Exc. Kit de Levantamiento	○ ○	○ ○	G63349	61524 81164	58349 77349 43111 ⁸ 49155 ⁷
75-80	4WD, Exc. Suspensión Quad y Kit de Levantamiento	○ ○	G63347	61516 81113	58347 ⁵⁰	
73-74	4WD; Con Kit de Levantamiento de 4"; Exc. Suspensión Quad	○ ○	58437 ⁵⁰	
	4WD, Con Kit de Levantamiento de 4"; Exc. Suspensión Quad	○ ○	G63437 ⁵⁰	○ ○	G63438 ⁵⁰	58438 ⁵⁰
	4WD, Exc. Kit de Levantamiento	○ ○	G63347	61516 81113	58347	
69-74	RWD	○ ○	G63355	61525 81039	58355 77355	
69-72	Resorte Trasero	○ ○	○ ○	82003 49107 ⁷
	Resorte Trasero de Hojas Múltiples	○ ○	○ ○	82006 49162 ⁷
	RWD; Resorte Trasero	○ ○	○ ○ 43062 ⁸
	RWD; Resorte Trasero de Hojas Múltiples	○ ○	○ ○ 43093 ⁸
	4WD	○ ○	G63347	61516 81113	58347	○ ○	G63371

BLAZER ESTABILIZADORES DE DIRECCIÓN 2WD

			Delantero	Trasero
79-84	RWD, Estabilizador de Dirección Sistema Dual		6802SE ⁸⁴
75-84	RWD		14017
	RWD, Estabilizador de Dirección Sistema Sencillo		6804SE ⁸⁰
69-72	Estabilizador de Dirección Sistema Sencillo		6803SE ⁸⁴

BLAZER ESTABILIZADORES DE DIRECCIÓN 4WD

			Delantero	Trasero
87-91	4WD, Full Size		14017
79-86	4WD, Estabilizador de Dirección Sistema Dual		6802SE ⁸⁴
75-86	4WD		14017
	4WD, Estabilizador de Dirección Sistema Sencillo		6804SE ⁸⁰
69-72	Estabilizador de Dirección Sistema Sencillo		6803SE ⁸⁴

BLAZER, S MODELS

83-05	Todos	↑	70173
	RWD	↑	70173
90-94	RWD 3.1L 2BBL	↑	42968 70173

6 Se recomienda que cuando se reemplacen amortiguadores "quad", los 4 sean de la misma serie.

8 Paquetes en pares



80 No requiere soportes para el montaje, instalar sobre montajes de EO Veá Ref. C para Botas.

7 Paquetes en pares; kit de mangueras de aire incluido

50 Para proteger la barra del pistón, se recomienda utilizar el kit Bellows No.141242.

84 Amortiguador de repuesto para los vehículos con el kit de montaje aftermarket GRC









AMORTIGUADORES Y STRUTS

Año	Notas de Aplicación	Front					Rear				
			ProGuard\ Guardian	LTV\ Max Control	Protector de Strut\ Bases de Strut	HiJacker\ Soporte\ Hidráulico		ProGuard\ Guardian	LTV\ Max Control	Protector de Strut\ Bases de Strut	HiJacker\ Soporte\ Hidráulico

CHEVROLET

CHEVROLET



BLAZER, S MODELS (cont)

88-94	4WD, Barra de Torsion(FrontSpringType)		142316 ⁵³		70173
83-94	Todos			G63422	61528 81482	58422 77422	43162 ⁸ 49213 ⁷ 70173
	4WD		G63423	61531 81516	58423 77423		70173
	RWD		G63421	61504 81750	58421 77421	34051 ⁸		70173





BLAZER, S MODELS ESTABILIZADORES DE DIRECCIÓN

		Delantero			Trasero	
83-94	Estabilizador de Dirección Sistema Sencillo; con orificio de montaje de EO en brazo de dirección	6801SE			



BOSS TRUCK

96-97	5.7L 8Cyl (350) MFI		G63489	61544 81668		61543 81667
-------	---------------------	---	--------	----------------	------	------	------	---	------	----------------	------	------	------



BROOKWOOD

71-72	Todos		69675 ⁵	81446	34073 ⁸		69604	81492
69-70	Todos		69675 ⁵	81446	34073 ⁸		69724	81514	43049 ⁸ 49131 ⁹⁰





C25

73-91	Todos		70164		70165
-------	-------	--	------	------	------	------	-------	--	------	------	------	------	-------



C35

73-91	Todos		70164	
-------	-------	---	------	------	------	------	-------	---	------	------	------	------	------



C1405

65-66	4.7L 8Cyl (283) 4WD; MFI		61525 81039	42961		82004
	4.8L 6Cyl (292) DOHC; MFI		61525 81039	42961		82004







C2000

73-91	Todos		70164		70165
-------	-------	---	------	------	------	------	-------	---	------	------	------	------	-------





C3000

73-91	Todos		70164	
-------	-------	---	------	------	------	------	-------	---	------	------	------	------	------



C3605

67	4.7L 8Cyl (283) 4WD; MFI		G63355	61525 81039		82003
	4.7L MFI		42961	
	4.8L 6Cyl (292) DOHC; MFI		61525 81039	42961		82003

C20905

65-67	4.7L 8Cyl (283) 4WD; MFI		G63355	61525 81039	42961		82003
	4.8L 6Cyl (292) DOHC; MFI		61525 81039	42961		82003

CAMARO

14-15	Exc. Electronic			G51916
-------	-----------------	---	------	------	------	------	------	---	--------	------	------	------	------

5 Use el kit 140719 para reemplazar partes del EO de montaje inferior cuando los pernos se rompan o los tornillos autoroscantes no se puedan utilizar más. 7 Paquetes en pares; kit de mangueras de aire incluido

30 Para Vehículos GM equipados con sistemas de nivelación de fábrica, vea Ref. A.

8 Paquetes en pares

53 Montaje de Strut. Es probable reutilizar algunas partes del E.O.

AMORTIGUADORES Y STRUTS

Año	Notas de Aplicación	From					Rear				
		Ultra	ProGuard\ Guardian	LTV\ Max Control	Protector de Strut\ Bases de Strut	HiJacker\ Soporte\ Hidráulico	Ultra	ProGuard\ Guardian	LTV\ Max Control	Protector de Strut\ Bases de Strut	HiJacker\ Soporte\ Hidráulico

CHEVROLET

CAMARO (cont)

CHEVROLET

13-15	SS, Izquierdo	↓	G52395
	SS, Derecho	↓	G52396
10-13	3.6L V6 Izquierdo	↓	G52280	↓	G51916
	3.6L V6 Derecho	↓	G52281	↓	G51916
11-12	Izquierdo	↓	143460 ⁵³	↓	143461 ⁵³
10-12	Derecho	↓	143460 ⁵³	↓	143462 ⁵³
	SS, Izquierdo	↓	G52395	↓	G51975
	SS, Derecho	↓	G52396	↓	G51975
10	Izquierdo	↓	143460 ⁵³	↓	143461
93-02	Todos	↓	G51204	142412 ⁶³	↓	69676	81481 75676
82-92	Todos	↓	G56700	↓	69676	81481 75676
70-81	Todos	↓	69675 ⁵	81446	34073 ⁸	↓	69624	81095
68-69	Todos	↓	69600	81494	↓
	Resorte Trasero de Hoja Sencilla	↓	69600	81494	↓	82040
	Resorte Trasero de Hojas Múltiples	↓	69600	81494	↓	69606	81495
67	Todos	↓	69600	81494	↓	82040

CAMARO READYMOUNTS

		Delantero	Trasero
93-02	Izquierdo	G57107 ⁴⁰
	Derecho	G57108 ⁴⁰

CAPRICE

91-96	Exc. Modelos Policía y Taxi	↓	69675 ⁵	81446	34073 ⁸	↓
81-96	Sedan Modelos Policía y Taxi	↓	G63375 ⁵	61555 81713 ⁵	77375	34073 ⁸	↓	69724	81514
77-96	Wagon	↓	69675 ⁵	34073 ⁸	↓	69604	81492
71-96	Todos	↓	69675 ⁵	34073 ⁸	↓
73-90	Wagon Exc. Modelos Policía y Taxi	↓	69675 ⁵	81446	34073 ⁸	↓
81	5.7L 8Cyl V (350)	↓	69675 ⁵	42446 34073 ⁸	↓
75-80	Exc. Wagon	↓	69675 ⁵	34073 ⁸	↓
80	Sedan Modelos Policía y Taxi	↓	G63375 ⁵	61555 81713 ⁵	77375	34073 ⁸	↓	69724	81514
78-79	Sedan	↓	69675 ⁵	77375	34073 ⁸	↓
	Sedan Modelos Policía y Taxi	↓	G63375 ⁵	61555 81713 ⁵	34073 ⁸	↓	69724	81514
75-77	Sedan Modelos Policía y Taxi	↓	G63375 ⁵	61555 81713 ⁵	77375	34073 ⁸	↓	69724	81514

5 Use el kit 140719 para reemplazar partes del EO de montaje inferior cuando los pernos se rompan o los tornillos autoroscantes no se puedan utilizar más.

8 Paquetes en pares

40 Strut ReadyMount. Ensamble Completo

63 El Kit de Montaje incluye: Aislador Parachoques. Es probable reutilizar algunas partes del E.O.



Texto en Negritas - Número de Parte Nuevo / Futuro

7 Paquetes en pares; kit de mangueras de aire incluido

30 Para Vehículos GM equipados con sistemas de nivelación de fábrica, vea Ref. A.

53 Montaje de Strut. Es probable reutilizar algunas partes del E.O.



















AMORTIGUADORES Y STRUTS

Año	Notas de Aplicación	Front					Rear				
			Ultra	ProGuard\ Guardian	LTV\ Max Control	Protector de Strut\ Bases de Strut	HiJacker\ Soporte\ Hidráulico		Ultra	ProGuard\ Guardian	LTV\ Max Control



CHEVROLET

CHEVROLET





CAPRICE (cont)

71-76	Wagon		69675 ⁵	34073 ⁸		69604	81492	49152 ³⁰
73-74	Sedan Modelos Policía y Taxi		G63375 ⁵	61555 81713 ⁵	77375	34073 ⁸		69724	81514	43049 ⁸ 49131 ³⁰
71-72	Modelos Policía y Taxi		G63375 ⁵	61555	34073 ⁸		43049 ⁸ 49131 ³⁰
	Sedan; Modelos Policía y Taxi		69675 ⁵	77375	34073 ⁸	
	Hardtop Exc. Modelos Policía y Taxi		69675 ⁵	81446	34073 ⁸	
	Hardtop Modelos Policía y Taxi		69675 ⁵	81713 ⁵	34073 ⁸		69724	81514
70	Todos		69675 ⁵	34073 ⁸		69724	81514	43049 ⁸ 49131 ³⁰
	Hardtop		69675 ⁵	81446	34073 ⁸		69724	81514	43049 ⁸ 49131 ³⁰
66-69	Todos		69675 ⁵	81446	34073 ⁸		69724	81514	43049 ⁸ 49131 ³⁰





















CAPTIVA

07-12	Todos			G63872
-------	-------	---	------	------	------	------	------	---	--------	------	------	------	------

CAPTIVA SPORT

07-12	Izquierdo		G52127	
	Derecho		G52128	

CAVALIER

99-05	Todos		G55698	143035 ⁵⁴		G55825	142413 ⁵³
95-98	Todos		G55698	142227 ⁵⁸		G55825	142413 ⁵³
90-94	2BBL 2.8L			42530
87-94	Izquierdo		G56706	142762 ⁵⁵		69749	81530	141974 ⁵³	49371 ⁷
	Derecho		G56705	142762 ⁵⁵		69749	81530	141974 ⁵³	49371 ⁷
84-86	Todos		142762 ⁵⁵		69749	81530	49371 ⁷
	Izquierdo Struts de EO no reconstruibles		G56706	142762 ⁵⁵		69749	81530	49371 ⁷
	Derecho Struts de EO no reconstruibles		G56705	142762 ⁵⁵		69749	81530	49371 ⁷
	Struts Reconstruibles de EO		G44451 ⁹⁸	142762 ⁵⁵		69749	81530	141974 ⁵³	49371 ⁷
82-83	Todos		142762 ⁵⁵		69749	81530	141974 ⁵³	49371 ⁷

CAVALIER READYMOUNTS

		Delantero	Trasero
99-05	Todos	G56951⁴⁰	G56938⁴⁰
95-98	Todos	G56939⁴⁰	G56938⁴⁰
92-94	Izquierdo	G56921⁴⁰
	Derecho	G56920⁴⁰

5 Use el kit 140719 para reemplazar partes del EO de montaje inferior cuando los pernos se rompan o los tornillos autoroscantes no se puedan utilizar más.

8 Paquetes en pares

40 Strut ReadyMount. Ensemble Completo

54 Kit con Montaje y Rodamiento. Es probable que reutilizar algunas partes del E.O.

65 El Kit de Montaje incluye: Asiento de Resorte Superior con Aislador. Es probable reutilizar algunas partes del E.O.

7 Paquetes en pares; kit de mangueras de aire incluido

30 Para Vehículos GM equipados con sistemas de nivelación de fábrica, vea Ref. A.



53 Montaje de Strut. Es probable reutilizar algunas partes del E.O.

58 El Kit de Montaje incluye: Rodamiento de Suspensión. Es probable reutilizar algunas partes del E.O.

98 Nota: El nivel de dificultad para instalar este producto es moderadamente alto. Por favor revise las instrucciones cuidadosamente antes de comenzar.

Texto en Negritas - Número de Parte Nuevo / Futuro

















AMORTIGUADORES Y STRUTS

Año	Notas de Aplicación										
		Ultra	ProGuard\ Guardian	LTV\ Max Control	Protector de Strut\ Bases de Strut	HiJacker\ Soporte\ Hidráulico	Ultra	ProGuard\ Guardian	LTV\ Max Control	Protector de Strut\ Bases de Strut	HiJacker\ Soporte\ Hidráulico

CHEVROLET

CHEVROLET















CELEBRITY

85-90	Todos	 G55514	142223 ⁶⁵ 142749 ⁶⁵	 69723	81517	141974 ⁵³	49370 ³⁰ 42517
82-90	Todos			42517
90	2.8L 2BBL		55514		42517
84	Todos		142223 ⁶⁵ 142749 ⁶⁵	 69723	81517	141974 ⁵³	49370 ³⁰ 42517
	Exc. Suspensión HD	 G55505		42517
	Suspensión HD	 G55514		42517
83	Todos	 G55505	142223 ⁶⁵	 69723	81517	141974 ⁵³	49370 ³⁰ 42517
82	Todos	 G55505	142223 ⁶⁵	55514	 69723	81517	141974 ⁵³	49370 ³⁰ 42517













CELEBRITY READYMOUNTS

		Delantero	Trasero
85-90	Todos	G56908⁶⁰
84	Suspensión HD	G56908⁶⁰



CENTURY

97	3.1L 6Cyl (191) RWD; 2BBL			81517	42517
91-96	3.1L 6Cyl (191) RWD; 2BBL		55514		81517	42517
95	2.2L 4Cyl (134) 2BBL		55514		81517	42517
90	2.8L 6Cyl (173) RWD; 2BBL		55514		81517	42517
89	3.1L 6Cyl (191) RWD; 2BBL		55514		81517	42517
85-86	2.8L 6Cyl (173) RWD; 2BBL		55514		81517	42517
83-84	2.8L 6Cyl (173) RWD; 2BBL		55514		81517



CHEVELLE

68-73	Todos	 69600	81494	34051 ⁸	 69604	81492	43060 ⁸ 49152 ³⁰
	4.8L DOHC, MFI	 69600	81494	42494 34051 ⁸	 69604	81492	43060 ⁸ 49152 ³⁰
70	3.8L 4BBL	 69600	81494	42494 34051 ⁸	 69604	81492	43060 ⁸ 49152 ³⁰
64-67	Todos		82138	
	Exc. Suspensión HD		82138	 69724	81514	43049 ⁸ 49131 ³⁰
	Suspensión HD		82138	 69604	81492	43060 ⁸ 49152 ³⁰

CHEVETTE

76-87	Todos		81322		81340
-------	-------	--	-------	------	------	------	--	-------	------	------	------

CHEVY

94-12	Todos	 G35098	56630	 69726	42520
-------	-------	--	------	------	------	-------	---	------	------	------	-------

8 Paquetes en pares

40 Strut ReadyMount. Ensemble Completo





65 El Kit de Montaje incluye: Asiento de Resorte Superior con Aislador. Es probable reutilizar algunas partes del E.O.

Texto en Negritas - Número de Parte Nuevo / Futuro

30 Para Vehículos GM equipados con sistemas de nivelación de fábrica, vea Ref. A.

53 Montaje de Strut. Es probable reutilizar algunas partes del E.O.





AMORTIGUADORES Y STRUTS

Año	Notas de Aplicación										
			Ultra	ProGuard\ Guardian	LTV\ Max Control	Protector de Strut\ Bases de Strut	HiJacker\ Soporte\ Hidráulico		Ultra	ProGuard\ Guardian	LTV\ Max Control

CHEVROLET

CHEVROLET

CHEVY II

68	Todos		69600	81494		
	Resorte Trasero de Hojas Múltiples		69600	81494	69724	81514	43049 ⁸ 49157 ⁷
	Resorte Trasero de Hoja Sencilla		69600	81494	82093	49193 ⁷
62-67	Todos		82070	82074





CHEVY PICK UP

98-06	Todos		G35098	56630	42577
-------	-------	---	--------	------	------	------	------	-------	------	------	------	------	------	-------

CHEYENE HUNTER

73-91	Todos		70164	70165
-------	-------	---	------	------	------	------	------	-------	------	------	------	------	------	-------









CHEYENNE

14-15	Todos.Exc. Suspensión Electrónica Ajustable		G51949	G63959	61690
07-13	Exc. Suspensión Electrónica Ajustable		G51870	G63959	61690
03-06	4WD; Exc. Suspensión Electrónica Ajustable		G63803	58803 77803	G63675	58412 77412
	RWD; Exc. Suspensión Electrónica Ajustable		G63783	58783 77783	G63662	58662 77662	43181

CHEYENNE READYMOUNTS

		Delantero	Trasero
07-13	4WD. RWD; Crew Cab & Extended Cab	G57000



CITATION / CITATION II

87-88	2.8L 2BBL		G55514	42517
86-88	Todos		G55514
	2.8L 6Cyl (173) RWD; 2BBL		G55514	55514	81517
86	X-11 2.8L 6Cyl (173) RWD; 2BBL		G55514	55514	81517	42517
84-85	Todos		142223 ⁵³ 142749 ⁶⁵	69723	81517	141974 ⁶³	49370 ³⁰ 42517
	Exc. Suspensión HD		G55505	42517
	Suspensión HD		G55514	42517
80-85	Todos		42517
80-83	Todos		G55505	142223 ⁵³	69723	81517	49370 ³⁰ 42517

CITATION / CITATION II READYMOUNTS

		Delantero	Trasero
84-85	Suspensión HD	G56908 ⁴⁰

CITY EXPRESS

15-16	Izquierdo		G52591	G64146
	Derecho		G52592	G64146

7 Paquetes en pares; kit de mangueras de aire incluido

30 Para Vehículos GM equipados con sistemas de nivelación de fábrica, vea Ref. A.

53 Montaje de Strut. Es probable reutilizar algunas partes del E.O.



8 Paquetes en pares

40 Strut ReadyMount. Ensamble Completo

65 El Kit de Montaje incluye: Asiento de Resorte Superior con Aislador. Es probable reutilizar algunas partes del E.O.



Texto en Negritas - Número de Parte Nuevo / Futuro

AMORTIGUADORES Y STRUTS

Año	Notas de Aplicación										
		Ultra	ProGuard\ Guardian	LTV\ Max Control	Protector de Strut\ Bases de Strut	HiJacker\ Soporte\ Hidráulico	Ultra	ProGuard\ Guardian	LTV\ Max Control	Protector de Strut\ Bases de Strut	HiJacker\ Soporte\ Hidráulico

CHEVROLET CLASSIC

CHEVROLET





04-05	Todos	 G55974	 G56501	142532 ⁵³
-------	-------	--	------	------	------	------	--	------	------	----------------------	------

CLASSIC READYMOUNTS

Delantero	Trasero
G56927⁴⁰	G56928⁴⁰

04-05	Todos						G56927⁴⁰		G56928⁴⁰		
-------	-------	--	--	--	--	--	----------------------------	--	----------------------------	--	--

COBALT





05-10	Exc. modelos SS		 69587
	Exc. Modelos SS y Sport	 G56810	143323 ⁵³	

COBALT READYMOUNTS





Delantero	Trasero
G57047⁴⁰
G57048⁴⁰

05-10	Exc. Modelos SS y Sport Izquierdo						G57047⁴⁰			
	Exc. Modelos SS y Sport Derecho						G57048⁴⁰			



















COLORADO

04-12	RWD, Suspensión de resorte Exc. Paquete Z71 Off Road	 G51850	 G63882
	Barra de Torsión	 G63884	 G63879

CORSA

02-08	Sedan Izquierdo	 G56979	
	Sedan Derecho	 G56978	

CORSICA

95-96	Izquierdo	 G56720	142227 ⁵⁸	 69407 ⁹	81790	141974 ⁵³	49614 ⁷
	Derecho	 G56719	142227 ⁵⁸	 69407 ⁹	81790	141974 ⁵³	49614 ⁷
92-94	Todos		142227 ⁵⁸	 69749	81530	141974 ⁵³
	Exc. Suspensión FE7 Izquierdo	 G56720 ⁹	142227 ⁵⁸	 69749	81530	141974 ⁵³	49371 ⁷
	Exc. Suspensión FE7 Derecho	 G56719 ⁹	142227 ⁵⁸	 69749	81530	141974 ⁵³	49371 ⁷
	Suspensión FE7 Izquierdo	 G56723	142227 ⁵⁸	 69749	81530	141974 ⁵³
	Suspensión FE7 Derecho	 G56724	142227 ⁵⁸	 69749	81530	141974 ⁵³
87-91	Izquierdo	 G56706	142762 ⁶⁵	 69749	81530	141974 ⁵³	49371 ⁷
	Derecho	 G56705	142762 ⁶⁵	 69749	81530	141974 ⁵³	49371 ⁷

CORSICA READYMOUNTS

Delantero	Trasero
G56917⁴⁰
G56916⁴⁰
G56919 ⁴⁰
G56921⁴⁰
G56920⁴⁰

95-96	Izquierdo						G56917⁴⁰			
	Derecho						G56916⁴⁰			
92-94	Exc. Suspensión FE7 Izquierdo						G56919 ⁴⁰			
87-91	Izquierdo						G56921⁴⁰			
	Derecho						G56920⁴⁰			

7 Paquetes en pares; kit de mangueras de aire incluido

40 Strut ReadyMount. Ensemble Completo

58 El Kit de Montaje incluye: Rodamiento de Suspensión. Es probable reutilizar algunas partes del E.O.



9 Vea Ref.D para los procedimientos de reemplazo de una Susp. Elect. Ajust. con un producto no ajust.

53 Montaje de Strut. Es probable reutilizar algunas partes del E.O.

65 El Kit de Montaje incluye: Asiento de Resorte Superior con Aislador. Es probable reutilizar algunas partes del E.O.

Texto en Negritas - Número de Parte Nuevo / Futuro

AMORTIGUADORES Y STRUTS

Año	Notas de Aplicación										
		Ultra	ProGuard\ Guardian	LTV\ Max Control	Protector de Strut\ Bases de Strut	HiJacker\ Soporte\ Hidráulico	Ultra	ProGuard\ Guardian	LTV\ Max Control	Protector de Strut\ Bases de Strut	HiJacker\ Soporte\ Hidráulico

CHEVROLET

CHEVROLET







CORVAIR

60-64	Todos		82099
-------	-------	---	-------	-------	-------	-------	-------	-------	-------	-------









CORVAIR TRUCK

61-64	Todos		82099
-------	-------	---	-------	-------	-------	-------	-------	-------	-------	-------

CORVETTE

97-04	Exc. Suspensión Electrónica Ajustable		G51904	G51871
89-96	Exc. Suspensión Electrónica Ajustable		69811 ⁹	81792	75811 ⁹	69795 ⁹	81791	75795
88	Todos		69794 ⁹	69795 ⁹	81791	75795
84-87	Todos		69714	75811 ⁹	69715
63-82	Todos		69625	69622	81880	49304 ⁷
60-62	Todos		82026	82155
53-59	Todos		82026	82039











CRUZE

16	Izquierdo		G52432
	Derecho		G52433
14-15	Izquierdo		G52432	143473	G51971	143474
	Derecho		G52433	143473	G51971	143474
11-13	Izquierdo		G52432	143473	G51971	143474 ⁸³
	Derecho		G52433	143473	G51971	143474 ⁸³
	Strut Mount		143473	143474
10	Todos		143473	143474

CRUZE LIMITED

16	Todos		143473	G51971	143474
----	-------	---	-------	-------	-------	--------	-------	--------	-------	-------	--------	-------

CS1073

79-84	Todos		77349
73-78	Todos		G63349
	4.1L 6Cyl (250) 4BBL		G63355	61525 81039	42961	G63349	61524 81164
	4.8L 6Cyl (292) DOHC, MFI		42961	G63349
	4.8L 6Cyl (292) DOHC; MFI		61525 81039	G63349	61524 81164
	5.7L MFI		G63349	61649
67-72	4.1L 6Cyl (250) 4BBL		G63355	61525 81039	42961	G63306	82006
64-72	Todos		G63306
	4.8L 6Cyl (292) DOHC, MFI		42961	G63306
	4.8L 6Cyl (292) DOHC; MFI		61525 81039	G63306	82006

7 Paquetes en pares; kit de mangueras de aire incluido
53 Montaje de Strut. Es probable reutilizar algunas partes del E.O.

9 Vea Ref.D para los procedimientos de reemplazo de una Susp. Elect. Ajust. con un producto no ajust.

Texto en Negritas - Número de Parte Nuevo / Futuro

AMORTIGUADORES Y STRUTS

Año	Notas de Aplicación	Front					Rear				
		Ultra	ProGuard\ Guardian	LTV\ Max Control	Protector de Strut\ Bases de Strut	HiJacker\ Soporte\ Hidráulico	Ultra	ProGuard\ Guardian	LTV\ Max Control	Protector de Strut\ Bases de Strut	HiJacker\ Soporte\ Hidráulico

CHEVROLET

CHEVROLET

CS1073 (cont)

69	5.4L 8Cyl (327) MFI	○	61525 81039	42961	○	G63306	82006
68	5.4L 8Cyl (327) MFI	○	G63355	61525 81039	42961	○	G63306	82006
64-67	5.4L 8Cyl (327) MFI	○	61525 81039	42961	○	G63306	82006
67	4.7L 8Cyl (283) 4WD; TBI	○	G63355	61525 81039	42961	○	G63306	82006
66	4.1L 6Cyl (250) 4BBL	○	61525 81039	42961	○	G63306	82006
	4.7L 8Cyl (283) 4WD; SOHC; FI	○	G63355	61525	○	G63306
	4.7L 8Cyl (283) 4WD; SOHC; SFI	○	81039	○	G63306
	4.7L 8Cyl (283) 4WD; TBI	○	○	G63306	82006
	4.7L SOHC, FI	○	42961	○	G63306
65	4.7L 8Cyl (283) 4WD; SFI	○	G63355	61525 81039	○	G63306	82006
	SFI	○	42961	○	G63306
64	4.7L 8Cyl (283) 4WD; MFI	○	G63355	61525	○	G63306
	4.7L 8Cyl (283) 4WD; SFI	○	81039	○	G63306	82006
	4.7L MFI	○	42961	○	G63306

CS31003

73-78	4.8L 6Cyl (292) DOHC; SFI	○	61525 81039	○	61649 81174
	4.8L DOHC, SFI	○	42961	○	81164
	4.8L DOHC; SFI	○	G63355	○	G63366
	5.7L 8Cyl (350) MFI	○	G63355	61525 81039	○	61649 81174
	5.7L MFI	○	G63355	42961	○	G63366	81164
70-72	5.4L MFI	○	○	G63306
	5.7L 8Cyl (350) MFI	○	G63355	61525 81039	○	G63306	82006
	5.7L MFI	○	G63355	42961	○	G63306
64-72	Todos	○	○	G63306
72	4.8L 6Cyl (292) DOHC; MFI	○	61525	○	G63306
	4.8L 6Cyl (292) DOHC; SFI	○	81039	○	G63306	82006
	4.8L DOHC, SFI	○	42961	○	G63306
	4.8L DOHC; SFI	○	○	G63306
	4.8L DOHC; SFI	○	G63355	○	G63306
64-71	4.8L 6Cyl (292) DOHC; MFI	○	61525 81039	○	G63306	82006
	4.8L DOHC; MFI	○	42961	○	G63306
	4.8L DOHC; MFI	○	G63355	○	G63306
68-69	5.4L 8Cyl (327) MFI	○	G63355	61525 81039	○	G63306	82006
64-69	5.4L MFI	○	G63355	42961	○	G63306
66-67	4.7L TBI	○	G63355	42961	○	G63306
64-67	5.4L 8Cyl (327) MFI	○	61525 81039	○	G63306	82006
67	4.7L 8Cyl (283) 4WD; TBI	○	G63355	61525 81039	○	G63306	82006

AMORTIGUADORES Y STRUTS

Año	Notas de Aplicación	Front					Rear				
		Ultra	ProGuard\ Guardian	LTV\ Max Control	Protector de Strut\ Bases de Strut	HiJacker\ Soporte\ Hidráulico	Ultra	ProGuard\ Guardian	LTV\ Max Control	Protector de Strut\ Bases de Strut	HiJacker\ Soporte\ Hidráulico

CHEVROLET

CHEVROLET

CS31003 (cont)

66	4.7L 8Cyl (283) 4WD; TBI	○	61525 81039	○	G63306	82006
64-65	4.7L 8Cyl (283) 4WD; TBI	○	G63355	61525 81039	42961	○	G63306	82006
	4.7L TBI	○	G63355	○	G63306

CUTLASS

95-97	3.1L 6Cyl (191) RWD; 2BBL		G55514	55514		69723	81517	42517
86-97	Todos		G55514
95-96	2.2L 4Cyl (134) 2BBL		G55514		69723	81517	42517
90-94	3.1L 6Cyl (191) RWD; 2BBL		G55514	55514		69723	81517
87-94	RWD; 2BBL 2.8L 6Cyl (173)		G55514	42517
94	2.2L 4Cyl (134) 2BBL		G55514		69723	81517
87-89	2.8L 6Cyl (173) RWD; 2BBL		G55514	55514		69723	81517
86	2.8L 6Cyl (173) RWD; 2BBL		G55514	55514		69723	81517	42517

DEL RAY

58	Todos		82118	82051
----	-------	--	------	-------	------	------	------	--	------	-------	------	------	------

EL CAMINO

78-87	Todos		61504 81750	34051 ⁸		81492	43060 ⁹ 49334 ³⁰
68-77	Todos		61504 81750	34051 ⁸		81492	43060 ⁹ 49152 ³⁰
64-67	Todos		82138	81514	43049 ⁹
59-60	Todos		82118	82051

EL CAMINO ESTABILIZADORES DE DIRECCIÓN

		Delantero		Trasero	
73-77	Todos	14019		

EQUINOX

14-16	Todos			G64140
12-13	Todos			G64015	61718
12	Izquierdo Exc. Suspensión Deportiva		G52127		G64015	61718
	Derecho Exc. Suspensión Deportiva		G52128		G64015	61718
07-11	Todos		143469 ⁵³		G64015	61718
	Izquierdo Exc. Suspensión Deportiva		G52127	143469 ⁵³		G64015	61718
	Derecho Exc. Suspensión Deportiva		G52128	143469 ⁵³		G64015	61718
05-06	Izquierdo		G56773	143363 ⁵³		G64015	61718
	Derecho		G56774	143363 ⁵³		G64015	61718



8 Paquetes en pares

30 Para Vehículos GM equipados con sistemas de nivelación de fábrica, vea Ref. A.

53 Montaje de Strut. Es probable reutilizar algunas partes del E.O.

Texto en Negritas - Número de Parte Nuevo / Futuro

AMORTIGUADORES Y STRUTS

Año	Notas de Aplicación										
		Ultra	ProGuard\ Guardian	LTV\ Max Control	Protector de Strut\ Bases de Strut	HiJacker\ Soporte\ Hidráulico	Ultra	ProGuard\ Guardian	LTV\ Max Control	Protector de Strut\ Bases de Strut	HiJacker\ Soporte\ Hidráulico

CHEVROLET

CHEVROLET

EQUINOX READYMOUNTS

		Delantero	Trasero
05-06	Izquierdo	G57110 ⁴⁰
	Derecho	G57111 ⁴⁰

EUROSPORT

93-96	3.1L 6Cyl (191) RWD; 4BBL	G55514	55514	69723	81517	42517
91-96	Todos	G55514	69723
92	3.1L 6Cyl (191) RWD; 2BBL	G55514	69723	81517
	3.1L 6Cyl (191) RWD; 4BBL	G55514	55514	69723	42517
91	3.1L 6Cyl (191) RWD; 2BBL	G55514	69723	81517	42517
	3.1L 6Cyl (191) RWD; 4BBL	G55514	55514	69723

EXPRESS 4500

10-15	Todos	G63897	61687
-------	-------	------	------	------	------	------	--------	-------	------	------	------

FIREBIRD TRANS AM

98-01	5.7L 8Cyl (350) MFI	69676	81481
94-96	5.7L 8Cyl (350) MFI	69676	81481

HHR

06-11	Todos	143323 ⁵³
	Exc. Modelo SS	G56810	143323 ⁵³
	Exc. modelos SS	143323 ⁵³	69587

HHR READYMOUNTS

		Delantero	Trasero
06-11	Exc. Modelo SS Izquierdo	G57047 ⁴⁰
	Exc. Modelo SS Derecho	G57048 ⁴⁰

IMPALA

12-16	Todos	G55948	142525 ⁵³ 142526 ⁵⁴	G55949
04-11	Modelos con Ruedas de 17" o 18"	G55948	142524 ⁵⁸ 142525 ⁵³ 142526 ⁵⁴	G52244
00-11	Todos	G55948	142524 ⁵⁸ 142525 ⁵³ 142526 ⁵⁴
	Exc. Modelos c/ Ruedas de 17" o 18"	G55948	142524 ⁵⁸ 142525 ⁵³ 142526 ⁵⁴	G55949
	Izquierdo	G55948	142524 ⁵⁸ 142525 ⁵³ 142526 ⁵⁴	143073 ⁵³
	Derecho	G55948	142524 ⁵⁸ 142525 ⁵³ 142526 ⁵⁴	143074 ⁵³

40 Strut ReadyMount. Ensemble Completo



54 Kit con Montaje y Rodamiento. Es probable que reutilizar algunas partes del E.O.

53 Montaje de Strut. Es probable reutilizar algunas partes del E.O.

58 El Kit de Montaje incluye: Rodamiento de Suspensión. Es probable reutilizar algunas partes del E.O.

Texto en Negritas - Número de Parte Nuevo / Futuro

AMORTIGUADORES Y STRUTS

Año	Notas de Aplicación										
		Ultra	ProGuard/ Guardian	LTV/ Max Control	Protector de Strut/ Bases de Strut	HiJacker/ Soporte/ Hidráulico	Ultra	ProGuard/ Guardian	LTV/ Max Control	Protector de Strut/ Bases de Strut	HiJacker/ Soporte/ Hidráulico

CHEVROLET

IMPALA (cont)

CHEVROLET

94-96	Todos	69675 ⁵	34073 ⁸	69724	81514	43049 ⁹ 49131 ³⁰
	Exc. Modelos Policía y Taxi	69675 ⁵	81446	34073 ⁸	69724	81514	43049 ⁹ 49131 ³⁰
83-85	Todos	69675 ⁵	34073 ⁸	69724	81514	43049 ⁹ 49131 ³⁰
	Exc. Modelos Policía y Taxi	69675 ⁵	81446	34073 ⁸	69724	81514	43049 ⁹ 49131 ³⁰
	Modelos Policía y Taxi	G63375 ⁵	61555 81713 ⁵	34073 ⁸	69724	81514	43049 ⁹ 49131 ³⁰
	Sedan Modelos Policía y Taxi	69675 ⁵	77375	34073 ⁸	69724	81514	43049 ⁹ 49131 ³⁰
82	Exc. Modelos Policía y Taxi	81446
	Exc. Wagon	69724	81514	43049 ⁹ 49131 ³⁰
	Sedan	69675 ⁵	34073 ⁸
	Sedan Modelos Policía y Taxi	G63375 ⁵	61555 81713 ⁵	77375
	Wagon	69604	81492	43060 ⁹ 49152 ³⁰
71-81	Todos	69675 ⁵	34073 ⁸
	Exc. Modelos Policía y Taxi	69675 ⁵	81446	34073 ⁸
	Sedan Modelos Policía y Taxi	G63375 ⁵	61555 81713 ⁵	77375	34073 ⁸
	Wagon	69675 ⁵	34073 ⁸	69604	81492	43060 ⁹ 49152 ³⁰
65-81	Exc. Wagon	69675 ⁵	34073 ⁸	69724	81514	43049 ⁹ 49131 ³⁰
76	4.1L 4BBL	69675 ⁵	42446 34073 ⁸	42514
75	4.1L 4BBL	69675 ⁵	42446 34073 ⁸
72	4.8L FI	69675 ⁵	42446 34073 ⁸	42514
71	4.8L DOHC, SFI	69675 ⁵	42446 34073 ⁸	42514
70	Todos	69675 ⁵	34073 ⁸	69724
	Exc. Modelos Policía y Taxi	69675 ⁵	81446	34073 ⁸	69724
	4.8L DOHC, SFI	69675 ⁵	42446 34073 ⁸	69724	42514
65-69	Todos	69675 ⁵	34073 ⁸	69724	49131 ³⁰
	Exc. Modelos Policía y Taxi	69675 ⁵	81446	34073 ⁸	69724	49131 ³⁰
	4.8L DOHC, SFI	69675 ⁵	42446 34073 ⁸	69724	42514 49131 ³⁰
65	4.1L 4BBL	69675 ⁵	42446 34073 ⁸	69724	42514 49131 ³⁰
59-64	Todos	82118	82051

IMPALA READYMOUNTS

		Delantero		Trasero	
12-16	Izquierdo	G57060 ⁴⁰		G56924 ⁴⁰	
	Derecho	G57060 ⁴⁰		G56925 ⁴⁰	
00-11	Todos	G57060 ⁴⁰		
	Izquierdo Exc. Modelos c/ Ruedas de 17" o 18"	G57060 ⁴⁰		G56924 ⁴⁰	
	Derecho Exc. Modelos c/ Ruedas de 17" o 18"	G57060 ⁴⁰		G56925 ⁴⁰	

KINGSWOOD

71-72	Todos	69675 ⁵	81446	34073 ⁸	69604	81492
-------	-------	--------------------	-------	------	------	--------------------	-------	-------	------	------	------

5 Use el kit 140719 para reemplazar partes del EO de montaje inferior cuando los pernos se rompan o los tornillos autoroscantes no se puedan utilizar más. 8 Paquetes en pares

40 Strut ReadyMount. Ensamble Completo

30 Para Vehículos GM equipados con sistemas de nivelación de fábrica, vea Ref. A.

Texto en Negritas - Número de Parte Nuevo / Futuro

AMORTIGUADORES Y STRUTS

Año	Notas de Aplicación	Front					Rear				
		Ultra	ProGuard\ Guardian	LTV\ Max Control	Protector de Strut\ Bases de Strut	HiJacker\ Soporte\ Hidráulico	Ultra	ProGuard\ Guardian	LTV\ Max Control	Protector de Strut\ Bases de Strut	HiJacker\ Soporte\ Hidráulico

CHEVROLET

CHEVROLET

KINGSWOOD (cont)

69-70	Todos	69675 ⁵	81446	34073 ⁸	69724	81514	43049 ⁸ 49131 ³⁰
-------	-------	--------------------	-------	------	------	--------------------	-------	-------	------	------	---

LUMINA

97-01	Todos	G44459 ³⁶	142143 ⁵³	G55831
	Izquierdo	G44459 ³⁶	142143 ⁵³	G55831	143073 ⁵³
95-96	Todos	G44459 ³⁶	142143 ⁵³	G55817
	Izquierdo	G44459 ³⁶	142143 ⁵³	G55817	143073 ⁵³
90-94	Todos	G44459 ³⁶	142143 ⁵³	G56708

LUMINA APV

90-96	Todos	G55992	142223 ⁵³ 142749 ⁶⁵	G63914	61503	141974 ⁵³	49370 ³⁰
-------	-------	--------	------	------	--	------	--------	-------	------	----------------------	---------------------

LUMINA READYMOUNTS

							Delantero	Trasero
95-96	Izquierdo						G56952 ⁴⁰
	Derecho						G56953 ⁴⁰
90-94	Todos						G56727 ⁴²

LUMINA VAN

97	3.3L 6Cyl (204) RWD; 4BBL	G44459
----	---------------------------	--------	------	------	------	------	------	------	------	------	------

LUV PICKUP

97	Todos	81478	81318
81-82	4WD	G63909	61508 81507	77909	G63492	61506 81318	77492	49311 ⁷
82	Todos	G63492	61506 81318	77492	49311 ⁷
	RWD	G63902	61501 81478	77902	70161	G63492	61506 81318	77492	49311 ⁷
81	Todos	77909	G63492	61506 81318	77492	49311 ⁷
	RWD	G63902	61501 81478	77909	70161	G63492	61506 81318	77492	49311 ⁷
75-80	Todos	G63909	61508 81507	77909	G63907	61500 81147	77907	43048 ⁸ 49151 ⁷ 70163
72-74	Todos	70163
	Todos	G63909	61508 81507	77909	G63907	61500 81147	77907	43048 ⁸ 49151 ⁷

LUV PICKUP ESTABILIZADORES DE DIRECCIÓN

							Delantero	Trasero
79-82	4WD, Estabilizador de Dirección Sistema Sencillo; con orificio de montaje de EO en brazo de dirección						6801SE ⁸⁰

MALIBU

13-15	Izquierdo	G52742
	Derecho	G52743

5 Use el kit 140719 para reemplazar partes del EO de montaje inferior cuando los pernos se rompan o los tornillos autoroscantes no se puedan utilizar más.

8 Paquetes en pares

36 Requiere una herramienta especial de instalación para struts.

42 Strut ReadyMount, no incluye resortes por el diseño del vehículo.

65 El Kit de Montaje incluye: Asiento de Resorte Superior con Aislador. Es probable reutilizar algunas partes del E.O.

Texto en Negritas - Número de Parte Nuevo / Futuro

7 Paquetes en pares; kit de mangueras de aire incluido





30 Para Vehículos GM equipados con sistemas de nivelación de fábrica, vea Ref. A.

40 Strut ReadyMount. Ensemble Completo

53 Montaje de Strut. Es probable reutilizar algunas partes del E.O.

80 No requiere soportes para el montaje, instalar sobre montajes de EO Vea Ref. C para Botas.









































AMORTIGUADORES Y STRUTS

Año	Notas de Aplicación										
			Ultra	ProGuard\ Guardian	LTV\ Max Control	Protector de Strut\ Bases de Strut	HiJacker\ Soporte\ Hidráulico		Ultra	ProGuard\ Guardian	LTV\ Max Control

CHEVROLET

CHEVROLET



MALIBU (cont)

09-12	Exc. Modelos Classic Izquierdo		143354 ⁵³	
	Exc. Modelos Classic Derecho		143355 ⁵³	
08-12	Exc. Modelo Classic			69590
04-12	Izquierdo		G52028	
	Derecho		G52029	
08	Exc. Modelos Classic Izquierdo		143354 ⁵³		143425 ⁵³
	Exc. Modelos Classic Derecho		143355 ⁵³		143425 ⁵³
	Modelo Classic			69589
04-07	Exc. Modelo Maxx			69589
	Exc. Modelos Classic Izquierdo		143354 ⁵³	
	Exc. Modelos Classic Derecho		143355 ⁵³	
	Modelo Maxx			69590	143425 ⁵³
98-03	Struts Traseros con orificios en Montaje Inferior separados a 2.4"		G55974		G56501	142532 ⁵³
97-03	Todos		G55974		142532 ⁵³
97-98	Struts Traseros con orificios en Montaje Inferior separados a 3.2"		G55974		G55975	142532 ⁵³
78-83	Todos		69600	81494	34051 ⁸		69604	81492	43060 ⁸ 49334 ³⁰
73-77	Todos		69600	81494	34051 ⁸		69604	81492	43060 ⁸ 49152 ³⁰
64-67	Todos		82138	
	Exc. Suspensión HD		82138		69724	81514	43049 ⁸ 49131 ³⁰
	Suspensión HD		82138		69604	81492	43060 ⁸ 49152 ³⁰





MALIBU READYMOUNTS

		Delantero		Trasero	
09-12	Exc. Modelo Hybrid Izquierdo	G57069 ⁴⁰		
	Exc. Modelo Hybrid Derecho	G57070 ⁴⁰		
08-10	4Cyl: Exc. Classic y Hybrid Models Izquierdo	G57121		
	4Cyl: Exc. Classic y Hybrid Models Derecho	G57122		
04-08	Exc. Modelo Hybrid Izquierdo	G57069		
	Exc. Modelo Hybrid Derecho	G57070		
00-03	Struts Traseros con orificios en Montaje Inferior separados a 2.4" y 3.2"	G56927 ⁴⁰		G56928 ⁴⁰	
97-03	Todos	G56927 ⁴⁰		
99	Struts Traseros con orificios en Montaje Inferior separados a 2.4"	G56927 ⁴⁰		G56928 ⁴⁰	
98	Struts Traseros con orificios en Montaje Inferior separados a 2.4" y 3.2"	G56927 ⁴⁰		G56928 ⁴⁰	

MALIBU TODOS

08-12	Todos			69590
-------	-------	---	------	------	------	------	---	-------	------	------	------	------

MATIZ

00-05	G1 Izquierdo		G52053		70019
	G1 Derecho		G52052		70019

8 Paquetes en pares

40 Strut ReadyMount. Ensamble Completo

Texto en Negritas - Número de Parte Nuevo / Futuro

30 Para Vehículos GM equipados con sistemas de nivelación de fábrica, vea Ref. A.

53 Montaje de Strut. Es probable reutilizar algunas partes del E.O.

AMORTIGUADORES Y STRUTS

Año	Notas de Aplicación	From					Rear				
		Ultra	ProGuard\ Guardian	LTV\ Max Control	Protector de Strut\ Bases de Strut	HiJacker\ Soporte\ Hidráulico	Ultra	ProGuard\ Guardian	LTV\ Max Control	Protector de Strut\ Bases de Strut	HiJacker\ Soporte\ Hidráulico

CHEVROLET

MATIZ G2

CHEVROLET

06-15	Izquierdo	G52223	G70015
	Derecho	G52224	G70015

MERIVA

03-08	Izquierdo	G56979	G69583
	Derecho	G56978	G69583

METRO

98-01	Non-ABS	G55891	142293 ⁵⁴	...	G55772	142295 ⁵³	...
-------	---------	--------	-----	-----	----------------------	-----	--------	-----	-----	----------------------	-----

MICROBUS

90-96	5.7L 8Cyl (350) MFI	G63489	61544 81668	G61543 81667
-------	---------------------	--------	----------------	-----	-----	-----	-----------------	-----	-----	-----	-----

MONTE CARLO

07	Todos	G55948	142526 ⁵⁴
	Exc. Modelos c/ Ruedas de 17" o 18"	G55948	142526 ⁵⁴	...	G55949
	Izquierdo	G55948	142526 ⁵⁴	143073 ⁵³	...
	Modelos con Llantas de 17" o 18"	G55948	142526 ⁵⁴	...	G52244
	Derecho	G55948	142526 ⁵⁴	143074 ⁵³	...
05-06	Modelos con Llantas de 17" o 18"	G55948	142524 ⁵⁸ 142525 ⁵³ 142526 ⁵⁴	...	G52244
00-06	Todos	G55948	142524 ⁵⁸ 142525 ⁵³ 142526 ⁵⁴
	Exc. Modelos c/ Ruedas de 17" o 18"	G55948	142524 ⁵⁸ 142525 ⁵³ 142526 ⁵⁴	...	G55949
	Izquierdo	G55948	142524 ⁵⁸ 142525 ⁵³ 142526 ⁵⁴	143073 ⁵³	...
	Derecho	G55948	142524 ⁵⁸ 142525 ⁵³ 142526 ⁵⁴	143074 ⁵³	...
97-99	Todos	G44459 ³⁶	G55831
	Exc. Suspensión HD	G44459 ³⁶	142143 ⁵³	...	G55831
	Izquierdo	G44459 ³⁶	G55831	143073 ⁵³	...
	Derecho	G44459 ³⁶	G55831	143074 ⁵³	...
95-96	Todos	G44459 ³⁶	G55817
	Exc. Suspensión HD	G44459 ³⁶	142143 ⁵³	...	G55817
	Izquierdo	G44459 ³⁶	G55817	143073 ⁵³	...
73-88	Todos	G69600	81494	34051 ⁸	G69604	81492	43060 ⁸ 49334 ³⁰

8 Paquetes en pares

36 Requiere una herramienta especial de instalación para struts.





54 Kit con Montaje y Rodamiento. Es probable que reutilizar algunas partes del E.O.

30 Para Vehículos GM equipados con sistemas de nivelación de fábrica, vea Ref. A.

53 Montaje de Strut. Es probable reutilizar algunas partes del E.O.

58 El Kit de Montaje incluye: Rodamiento de Suspensión. Es probable reutilizar algunas partes del E.O.



AMORTIGUADORES Y STRUTS

Año	Notas de Aplicación										
			Ultra	ProGuard\ Guardian	LTV\ Max Control	Protector de Strut\ Bases de Strut	HiJacker\ Soporte\ Hidráulico		Ultra	ProGuard\ Guardian	LTV\ Max Control

CHEVROLET

CHEVROLET

MONTE CARLO (cont)

70-72	Todos		69600	81494	34051 ⁸		69604	81492	43060 ⁹ 49152 ³⁰
-------	-------	---	-------	-------	------	------	--------------------	---	-------	-------	------	------	---



MONTE CARLO ESTABILIZADORES DE DIRECCIÓN

										Delantero	Trasero		
73-77	Todos											14019

















MONTE CARLO READYMOUNTS

										Delantero	Trasero		
00-07	Todos											G57060 ⁴⁰
	Izquierdo Exc. Modelos c/ Ruedas de 17" o 18"											G57060 ⁴⁰	G56924 ⁴⁰
	Derecho Exc. Modelos c/ Ruedas de 17" o 18"											G57060 ⁴⁰	G56925 ⁴⁰





MONZA

75-80	Todos		82129		81438
-------	-------	---	------	-------	------	------	------	---	------	-------	------	------	------





NOVA

85-88	Todos		G55715		G55752	142249 ⁵³
74-79	Todos		69600	81494	34051 ⁸		82093
69-73	Todos		69600	81494	34051 ⁸	
73	Exc. Suspensión HD		69600	81494	34051 ⁸		82093	49193 ⁷
	Suspensión HD		69600	81494	34051 ⁸		69724	81514	49157 ⁷
69-72	Resorte Trasero de Hoja Sencilla		69600	81494	34051 ⁸		49193 ⁷
	Resorte Trasero de Hojas Múltiples		69600	81494	34051 ⁸		69724	81514	43049 ⁸ 49157 ⁷
	Leaf(RearSpringType) Resorte Trasero de Hoja Sencilla		69600	81494	34051 ⁸		82093



ONE-FIFTY SERIES

55-57	Todos		69625	82099		82066
53-54	Todos		82026		82155



















OPTRA

04-10	Izquierdo		G56882	143349 ⁵³		G56884	143350 ⁵³
	Derecho		G56883	143349 ⁵³		G56885	143350 ⁵³

P31

99	5.7L 8Cyl (350) SFI			61649 81174
----	---------------------	---	------	------	------	------	------	---	------	----------------	------	------	------

PICKUP

60	Todos		82035		82086
57-58	Todos		82047	
	3800 2nd Series		82047		82155
	Modelos 3100, 3200 y 3600		82047		82060
55-56	Todos		G63405	
	3100, 3124, 3800 2nd Series		G63405	43048	
	3200		G63405	77405	
	3200 y 3600 2nd Series		G63405	81147	
	3800 2nd Series		G63405	61500 81147	77405		82155

7 Paquetes en pares; kit de mangueras de aire incluido

30 Para Vehículos GM equipados con sistemas de nivelación de fábrica, vea Ref. A.

53 Montaje de Strut. Es probable reutilizar algunas partes del E.O.

Texto en Negritas - Número de Parte Nuevo / Futuro

8 Paquetes en pares

40 Strut ReadyMount. Ensemble Completo

AMORTIGUADORES Y STRUTS

Año	Notas de Aplicación	Front					Rear				
		Ultra	ProGuard/ Guardian	LTV/ Max Control	Protector de Strut/ Bases de Strut	HiJacker/ Soporte/ Hidráulico	Ultra	ProGuard/ Guardian	LTV/ Max Control	Protector de Strut/ Bases de Strut	HiJacker/ Soporte/ Hidráulico

CHEVROLET

CHEVROLET

PICKUP (cont)

55	Primeras Series	○	G63405	81270
	3100, 3124 2nd Series	○	G63405	61500 81147	77405
54	Todos	⊥	81270
50-53	3100, 3200, 3600 y 3800	⊥	81270

PICKUP 1/2 TON, C10

87-91	Todos	⊥	70164	
87	5.7L MFI	⊥	42961 70164	42958	
79-86	Todos	○	G63355	61525 81039	58355 77355	34036 ⁶ 42961 70164	○	G63349	61524 81164	58349 77349 42958 43111 ⁸ 49155 ⁷
75-78	Todos	○	G63355	61525 81039	58355 77355	34036 ⁶	○	G63349	61524 81164	58349 77349 43111 ⁸ 49155 ⁷
73-74	Todos	○	G63355	61525 81039	58355 77355	34036 ⁶ 70164	○	61524 81164	58349 77349 43111 ⁸ 49155 ⁷
67-72	Resorte Trasero	○	G63355	61525 81039	58355 77355	34036 ⁶ 70164	○	82003 43062 ⁸ 49107 ⁷
63-72	Todos	○	G63355	61525 81039	58355 77355	34036 ⁶ 70164	○
	Resorte Trasero de Hojas Múltiples	○	G63355	61525 81039	58355 77355	34036 ⁶ 70164	○	G63306	82006 43093 ⁸ 49162 ⁷
61-62	Todos	○	82035	○	82086

PICKUP 1/2 TON, C10 ESTABILIZADORES DE DIRECCIÓN

		Delantero	Trasero
73-86	Estabilizador de Dirección Sistema Sencillo	6802SE ⁸⁴

PICKUP 1/2 TON, C15 / C1500

92-99	Todos	⊥	G63489	61544 81668	58489 77489	⊥	G63488	61543 81667	58488 77488 43163 ⁸ 49218 ⁷
88-91	Todos	⊥	G63489	61544 81668	58489 77489	70164	⊥	G63488	61543 81667	58488 77488 43163 ⁸ 49218 ⁷ 70165
73-91	Todos	⊥	70164	⊥ 70165

PICKUP 1/2 TON, C15 / C1500 ESTABILIZADORES DE DIRECCIÓN

		Delantero	Trasero
92-99	Exc. Estabilizador de Dirección de EO	6853SE ⁸²

PICKUP 1/2 TON, K10

81-86	Suspensión Estándar; Exc. Kit de Levantamiento	○	G63347	81113	58347	43107 ⁸	○	58349 49155 ⁷
	Suspensión Quad Amortiguador Corto; Exc. Kit de Levantamiento	○	G63908 ⁶	61516	58908 ⁶	○
	Suspensión Quad Amortiguador Largo; Exc. Kit de Levantamiento	○	G63906 ⁶	61522 ⁶ 81496 ⁶	58906 ⁶	○
75-86	Exc. Suspensión Quad y Kit de Levantamiento	○	○	G63349	61524 81164	77349 43111 ⁸
73-86	Con Kit de Levantamiento de 4"; Exc. Suspensión Quad	○	G63437 ⁵⁰	58437 ⁵⁰	○	G63438 ⁵⁰	58438 ⁵⁰
75-80	Exc. Kit de Levantamiento	○	G63347	61516 81113	58347	43107 ⁸	○	58349 49155 ⁷
74	Exc. Kit de Levantamiento	○	61516 81113	58347	43107 ⁸	○	58349 49155 ⁷
	Exc. Suspensión Quad y Kit de Levantamiento	○	G63347	○	G63349	61524 81164	77349 43111 ⁸
73	Exc. Kit de Levantamiento	○	81113	58347	43107 ⁸	○	58349 49155 ⁷

6 Se recomienda que cuando se reemplacen amortiguadores "quad", los 4 sean de la misma serie.

8 Paquetes en pares





82 Use kit si está señalado. Vea Ref. C para Botas.

7 Paquetes en pares; kit de mangueras de aire incluido

50 Para proteger la barra del pistón, se recomienda utilizar el kit Bellows No.141242.

84 Amortiguador de repuesto para los vehículos con el kit de montaje aftermarket GRC







AMORTIGUADORES Y STRUTS

Año	Notas de Aplicación										
			Ultra	ProGuard\ Guardian	LTV\ Max Control	Protector de Strut\ Bases de Strut	HiJacker\ Soporte\ Hidráulico		Ultra	ProGuard\ Guardian	LTV\ Max Control

CHEVROLET

CHEVROLET









PICKUP 1/2 TON, K10 (cont)

73	Exc. Suspensión Quad y Kit de Levantamiento		G63347	61516		G63349	61524 81164	77349	43111 ⁸
69-72	Todos		G63347		G63371
	Exc. Kit de Levantamiento		G63347	61516 81113	58347	43107 ⁸		G63371

PICKUP 1/2 TON, K10 ESTABILIZADORES DE DIRECCIÓN

		Delantero		Trasero	
73-86	Todos	14017		
	Estabilizador de Dirección Sistema Dual	6802SE ⁸⁴		
	Estabilizador de Dirección Sistema Sencillo	6804SE ⁸⁰		
67-72	Estabilizador de Dirección Sistema Dual	6802SE ⁸⁴		
61-72	Estabilizador de Dirección Sistema Sencillo	6803SE ⁸⁴		



PICKUP 1/2 TON, K15 / K1500

00	5.7L 8Cyl (350) MFI			61642
88-99	Todos		G63818	58901 77609		G63488	61543 81667	58488 77488	43163 ⁸ 49218 ⁷
88	Suspensión Quad Amortiguador Corto; Exc. Kit de Levantamiento		G63818	61516 ⁶	58901 77609		G63488	61543 81667	58488 77488	43163 ⁸ 49218 ⁷
	Suspensión Quad Amortiguador Largo; Exc. Kit de Levantamiento		G63818	61522 ⁶	58901 77609		G63488	61543 81667	58488 77488	43163 ⁸ 49218 ⁷

PICKUP 1/2 TON, K15 / K1500 ESTABILIZADORES DE DIRECCIÓN

		Delantero		Trasero	
88-99	Estabilizador de Dirección Sistema Sencillo	6807SE ⁸⁰		
92-97	Exc. Estabilizador de Dirección de EO	6853SE ⁸⁰		





















PICKUP 1/2 TON, R10

87	Todos		G63355	61525 81039	58355 77355	34036 ⁸		G63349	61524 81164	58349 77349	43111 ⁸ 49155 ⁷
----	-------	---	--------	----------------	----------------	------	--------------------	---	--------	----------------	----------------	------	--

PICKUP 1/2 TON, R10 ESTABILIZADORES DE DIRECCIÓN

		Delantero		Trasero	
87	Estabilizador de Dirección Sistema Sencillo	6802SE ⁸⁴		

PICKUP 1/2 TON, SILVERADO 1500

14-15	Todos		G51949	
	Exc. Suspensión Electrónica Ajustable		G51949		G63959
15	Exc. Suspensión Electrónica Ajustable		G51949		61690
	Plataforma K2XX		G51949		77974
14	Exc. Modelo Classic y Suspensión Electrónica Ajustable		G51949		G63959
	Exc. Modelo Classic y Suspensión Electrónica Ajustable		G51949		61690
07-13	Todos			77976
	Exc. Modelo Classic y Suspensión Electrónica Ajustable		G51870	143316 ⁸³		G63959	61690	77976
07	RWD; Classic Models Only; Exc. Suspensión Electrónica Ajustable			61600	77976
	RWD; Sólo Modelos Classic; Exc. Suspensión Electrónica Ajustable			58412 77976

6 Se recomienda que cuando se reemplacen amortiguadores "quad", los 4 sean de la misma serie.

8 Paquetes en pares

80 No requiere soportes para el montaje, instalar sobre montajes de EO Vea Ref. C para Botas.

7 Paquetes en pares; kit de mangueras de aire incluido

53 Montaje de Strut. Es probable reutilizar algunas partes del E.O.

84 Amortiguador de repuesto para los vehículos con el kit de montaje aftermarket

GRC

AMORTIGUADORES Y STRUTS

Año	Notas de Aplicación	From					Rear				
		Ultra	ProGuard\ Guardian	LTV\ Max Control	Protector de Strut\ Bases de Strut	HiJacker\ Soporte\ Hidráulico	Ultra	ProGuard\ Guardian	LTV\ Max Control	Protector de Strut\ Bases de Strut	HiJacker\ Soporte\ Hidráulico

CHEVROLET

CHEVROLET

PICKUP 1/2 TON, SILVERADO 1500 (cont)

99-06	4WD; Classic y Old Body Style; Exc. Suspensión Electrónica Ajustable	⊥ ⊕	G63803	61643 81922	58803 77803	⊕ ⊕	G63675	61642 81921	58412 77412
	RWD; Sólo Modelos Classic; Exc. Suspensión Electrónica Ajustable	⊥ ⊕	G63783	61641 81920	58783 77783	⊕ ⊕	G63662	61600 81873	58662 77662	43181 ⁶ 49235 ⁷

PICKUP 1/2 TON, SILVERADO 1500 HD

05-06	Todos	⊥ ⊕	G63817	61663 81925	58817 77817	⊕ ⊕	G63675	61642 81921	58412 77412
01-03	Todos	⊥ ⊕	G63817	61663 81925	58817 77817	⊕ ⊕	G63675	61642 81921	58412 77412

PICKUP 1/2 TON, SILVERADO 1500 READYMOUNTS

		Delantero		Trasero	
07-13	4WD, Exc. Control de Manejo Electrónico	G57000 ⁴⁰		
	RWD, Crew Cab Pickup Exc. Control de Manejo Electrónico	G57000 ⁴⁰		
	RWD, Extended Cab Pickup Exc. Control de Manejo Electrónico	G57000 ⁴⁰		
	RWD; Exc. Modelo Classic y Electronic Ride	G57023⁴⁰		

PICKUP 1/2 TON, V10

87	Todos	⊥ ⊕	⊕ ⊕	49155 ⁷
	Con Kit de Levantamiento de 4"; Exc. Suspensión Quad	⊕ ⊕	G63437 ⁵⁰	58437 ⁵⁰	⊕ ⊕	G63438 ⁵⁰	58438 ⁵⁰	49155 ⁷
	Exc. Suspensión Quad y Kit de Levantamiento	⊕ ⊕	G63347	58347	43107 ⁸	⊕ ⊕	G63349	61524 81164	58349 77349	43111 ⁸ 49155 ⁷
	Suspensión Quad Amortiguador Corto; Exc. Kit de Levantamiento	⊕ ⊕	G63908 ⁶	61516 ⁶ 81113 ⁶	58908 ⁶	⊕ ⊕	49155 ⁷
	Suspensión Quad Amortiguador Largo; Exc. Kit de Levantamiento	⊕ ⊕	G63906 ⁶	61522 ⁶ 81496 ⁶	58906 ⁶	⊕ ⊕	49155 ⁷

PICKUP 1/2 TON, V10 ESTABILIZADORES DE DIRECCIÓN

		Delantero		Trasero	
87	Todos	14017		
	Estabilizador de Dirección Sistema Dual	6802SE ⁸⁴		
	Estabilizador de Dirección Sistema Sencillo	6804SE ⁸⁰		

PICKUP 3/4 TON, C20

75-91	Todos	⊥ ⊕	70164	⊥ ⊕	70165
85-87	5.7L MFI	⊥ ⊕	42961 70164	⊥ ⊕	42958 70165
75-86	Crew Cab Pickup	⊕ ⊕	G63355	61525 81039	58355 77355	34036 ⁶ 70164	⊕ ⊕	G63366	61649 81174	58366	70165
	Standard Cab Pickup	⊕ ⊕	G63355	61525 81039	58355 77355	34036 ⁶ 70164	⊕ ⊕	G63349	61524 81164	58349 77349	43111 ⁸ 49155 ⁷ 70165
73-74	Todos	⊥ ⊕	⊥ ⊕	70165
	Todos	⊥ ⊕	70164	⊥ ⊕	70165
	Crew Cab Pickup	⊕ ⊕	G63355	61525 81039	58355 77355	34036 ⁶	⊕ ⊕	61649 81174	58366	70165
	Standard Cab Pickup	⊕ ⊕	⊕ ⊕	61524 81164	58349 77349	43111 ⁸ 49155 ⁷ 70165
67-72	Todos	⊕ ⊕	G63355	61525 81039	58355 77355	34036 ⁶ 70164	⊕ ⊕	G63306
	Resorte Trasero	⊕ ⊕	G63355	61525 81039	58355 77355	34036 ⁶ 70164	⊕ ⊕	G63306	82003	43062 ⁸ 49107 ⁷
	Resorte Trasero de Hojas Múltiples	⊕ ⊕	G63355	61525 81039	58355 77355	34036 ⁶ 70164	⊕ ⊕	G63306	82006	43093 ⁸ 49162 ⁷

6 Se recomienda que cuando se reemplacen amortiguadores "quad", los 4 sean de la misma serie. 7 Paquetes en pares; kit de mangueras de aire incluido

8 Paquetes en pares

50 Para proteger la barra del pistón, se recomienda utilizar el kit Bellows No.141242.

84 Amortiguador de repuesto para los vehículos con el kit de montaje aftermarket

GRC





Texto en Negritas - Número de Parte Nuevo / Futuro

40 Strut ReadyMount. Ensemble Completo

80 No requiere soportes para el montaje, instalar sobre montajes de EO Vea Ref. C para

Botas.





AMORTIGUADORES Y STRUTS

Año	Notas de Aplicación										
			Ultra	ProGuard\ Guardian	LTV\ Max Control	Protector de Strut\ Bases de Strut	HiJacker\ Soporte\ Hidráulico		Ultra	ProGuard\ Guardian	LTV\ Max Control

CHEVROLET

CHEVROLET









PICKUP 3/4 TON, C20 (cont)

63-66	Todos		G63355	61525 81039	58355 77355	34036 ⁸ 70164		G63306	43093 ⁸ 49162 ⁷
61-62	Todos		82035		82086

PICKUP 3/4 TON, C20 ESTABILIZADORES DE DIRECCIÓN

63-86	Estabilizador de Dirección Sistema Sencillo	Delantero	Trasero
		6802SE ⁸⁴



























PICKUP 3/4 TON, C25 / C2500

92-00	Todos		G63489	61544 81668	58489 77489		G63488	61543 81667	58488 77488	43163 ⁸ 49218 ⁷
88-91	Todos		G63489	61544 81668	58489 77489	70164		G63488	61543 81667	58488 77488	43163 ⁸ 49218 ⁷ 70165
	5.7L MFI		42961 70164		70165
73-91	Todos		70164		70165

PICKUP 3/4 TON, C25 / C2500 ESTABILIZADORES DE DIRECCIÓN

92-99	Exc. Estabilizador de Dirección de EO	Delantero	Trasero
		6853SE ⁸²

PICKUP 3/4 TON, K20

81-86	Suspensión Estándar; Exc. Kit de Levantamiento		G63347	81113	58347	43107 ⁸		58349	49155 ⁷
	Suspensión Quad Amortiguador Corto; Exc. Kit de Levantamiento		G63908 ⁶	61516	58908 ⁶	
	Suspensión Quad Amortiguador Largo; Exc. Kit de Levantamiento		G63906 ⁶	61522 ⁶ 81496 ⁶	58906 ⁶	
75-86	Exc. Suspensión Quad y Kit de Levantamiento			G63349	61524 81164	77349	43111 ⁸
73-86	Con Kit de Levantamiento de 4"; Exc. Suspensión Quad		G63437 ⁵⁰	58437 ⁵⁰		G63438 ⁵⁰	58438 ⁵⁰
75-80	Exc. Kit de Levantamiento		G63347	61516 81113	58347	43107 ⁸		58349	49155 ⁷
73-74	Exc. Kit de Levantamiento		61516 81113	58347		58349	49155 ⁷
	Exc. Suspensión Quad y Kit de Levantamiento		G63347	43107 ⁸		61524 81164	77349	43111 ⁸
71-72	Todos			G63371
	Exc. Kit de Levantamiento		61516 81113	58347		G63371
	Exc. Suspensión Quad y Kit de Levantamiento		G63347		G63371
69-70	Exc. Kit de Levantamiento		61516 81113	58347	
	Exc. Suspensión Quad y Kit de Levantamiento		G63347	

PICKUP 3/4 TON, K20 ESTABILIZADORES DE DIRECCIÓN

73-86	Todos	Delantero	Trasero
	Estabilizador de Dirección Sistema Dual	14017
	Estabilizador de Dirección Sistema Sencillo	6802SE ⁸⁴
	Estabilizador de Dirección Sistema Sencillo	6804SE ⁸⁰
67-72	Estabilizador de Dirección Sistema Dual	6802SE ⁸⁴
61-72	Estabilizador de Dirección Sistema Sencillo	6803SE ⁸⁴

6 Se recomienda que cuando se reemplacen amortiguadores "quad", los 4 sean de la misma serie.

8 Paquetes en pares

80 No requiere soportes para el montaje, instalar sobre montajes de EO Vea Ref. C para Botas.



84 Amortiguador de repuesto para los vehículos con el kit de montaje aftermarket GRC

7 Paquetes en pares; kit de mangueras de aire incluido

50 Para proteger la barra del pistón, se recomienda utilizar el kit Bellows No.141242.

82 Use kit si está señalado. Vea Ref. C para Botas.

AMORTIGUADORES Y STRUTS

Año	Notas de Aplicación										
		Ultra	ProGuard\ Guardian	LTV\ Max Control	Protector de Strut\ Bases de Strut	HiJacker\ Soporte\ Hidráulico	Ultra	ProGuard\ Guardian	LTV\ Max Control	Protector de Strut\ Bases de Strut	HiJacker\ Soporte\ Hidráulico

CHEVROLET

CHEVROLET

PICKUP 3/4 TON, K25 / K2500

88-00	Todos	○	G63609	61542 81726	58609 77609	○	G63488	61543 81667	58488 77488	43163 ⁸ 49218 ⁷
-------	-------	---	--------	----------------	----------------	------	------	---	--------	----------------	----------------	------	--

PICKUP 3/4 TON, K25 / K2500 ESTABILIZADORES DE DIRECCIÓN

99-00	Exc. Estabilizador de Dirección de EO	Delantero										Trasero
88-99	Estabilizador de Dirección Sistema Sencillo	6853SE ⁸²									
		6807SE ⁸⁰									

PICKUP 3/4 TON, R20

87-88	Crew Cab Pickup	○	G63355	61525 81039	58355 77355	34036 ⁸	○	G63366	61649 81174	58366
87	Standard Cab Pickup	○	58355	○	G63349	61524 81164	58349 77349	43111 ⁸ 49155 ⁷

PICKUP 3/4 TON, R20 ESTABILIZADORES DE DIRECCIÓN

87-88	Estabilizador de Dirección Sistema Sencillo	6802SE ⁸⁴										Trasero
											

PICKUP 3/4 TON, R2500

89	Todos	○	61525 81039	58355 77355	○	G63366	61649 81174	58366
	RWD	○	G63355	61525 81039	58355 77355	34036 ⁸	○	G63366	61649 81174	58366

PICKUP 3/4 TON, R2500 ESTABILIZADORES DE DIRECCIÓN

89	Estabilizador de Dirección Sistema Sencillo	6802SE ⁸⁴										Trasero
											

PICKUP 3/4 TON, SILVERADO 2500

14	Todos	○	○	G64121
11-13	Todos	○	○	G64121	58943
05-08	Todos	○	G63817	61663 81925	58817 77817	○	G63675	61642 81921	58412 77412
05-06	RWD, PBV 8600 Lb.; Exc. Suspensión Quadrateer	○	G63817	61663 81925	58783 58817 77817	○	G63675	61642 81921	58412 77412
99-04	Todos	○	○	G63675	61642 81921	58412 77412
	4WD	○	G63817	61663 81925	58817 77817	○	G63675	61642 81921	58412 77412
	RWD, PBV 8600 Lb.; Exc. Suspensión Quadrateer	○	G63783	61641 81920	58783 77783	○	G63675	61642 81921	58412 77412

PICKUP 3/4 TON, SILVERADO 2500 HD

11-13	Todos	○	○	58943
01-10	RWD	○	G63783	61641 81920	58783 77783	○	G63675	61642 81921	58412 77412
	PBV 9200	○	G63817	61663 81925	58817 77817	○	G63675	61642 81921	58412 77412

PICKUP 3/4 TON, SILVERADO 2500 HD ESTABILIZADORES DE DIRECCIÓN

11-13	Todos	14075										Trasero
01-09	9200# PBV sin Unidad de EO - 15059138 15155638	6803SE ⁸⁴									
	4WD, PBV 9200 con Amortiguador de EO 15059138, 15155638	6853SE ⁸²									

PICKUP 3/4 TON, V20

87	Todos	○	○	49155 ⁷
----	-------	---	------	------	------	------	------	---	------	------	------	------	--------------------

7 Paquetes en pares; kit de mangueras de aire incluido

80 No requiere soportes para el montaje, instalar sobre montajes de EO Vea Ref. C para Botas.





84 Amortiguador de repuesto para los vehiculos con el kit de montaje aftermarket

GRC

8 Paquetes en pares

82 Use kit si está señalado. Vea Ref. C para Botas.









AMORTIGUADORES Y STRUTS

Año	Notas de Aplicación										
			Ultra	ProGuard\ Guardian	LTV\ Max Control	Protector de Strut\ Bases de Strut	HiJacker\ Soporte\ Hidráulico		Ultra	ProGuard\ Guardian	LTV\ Max Control

CHEVROLET

CHEVROLET

















PICKUP 3/4 TON, V20 (cont)

87	Con Kit de Levantamiento de 4"; Exc. Suspensión Quad		G63437 ⁵⁰	58437 ⁵⁰		G63438 ⁵⁰	58438 ⁵⁰	49155 ⁷
	Exc. Suspensión Quad y Kit de Levantamiento		G63347	61516	58347	43107 ⁸		G63349	61524 81164	58349 77349	43111 ⁸ 49155 ⁷
	Suspensión Quad Amortiguador Corto; Exc. Kit de Levantamiento		G63908 ⁶	58908 ⁶		49155 ⁷
	Suspensión Quad Amortiguador Largo; Exc. Kit de Levantamiento		G63906 ⁶	61522 ⁶ 81496 ⁶	58906 ⁶		49155 ⁷

PICKUP 3/4 TON, V20 ESTABILIZADORES DE DIRECCIÓN

		Delantero	Trasero
87	Todos	14017
	Estabilizador de Dirección Sistema Dual	6802SE ⁸⁴
	Estabilizador de Dirección Sistema Sencillo	6804SE ⁸⁰

























PICKUP 1 TON, C30

63-91	Todos		70164		
87	5.7L MFI		42961 70164		
79-86	5.7L MFI		42961 70164		42958	
75-86	Todos		G63355	61525 81039	58355 77355	34036 ⁸ 70164		G63366	61649 81174	58366
73-74	Todos		G63355	61525 81039	58355 77355	34036 ⁸ 70164		61649 81174	58366
67-72	Exc. Eje Trasero 11,000#		70164		G63306	82006	43093 ⁸ 49162 ⁷
63-72	Todos		G63355	61525 81039	58355 77355	34036 ⁸ 70164	
61-62	Todos		82035	

PICKUP 1 TON, C30 ESTABILIZADORES DE DIRECCIÓN

		Delantero	Trasero
73-86	Estabilizador de Dirección Sistema Sencillo c/ Cooler	6802SE ⁸⁴
61-72	Estabilizador de Dirección Sistema Sencillo	6802SE ⁸⁴

PICKUP 1 TON, C35/3500

01-03	Base, Eje Delantero Rígido HD		77489	
	Eje Delantero Rígido HD			G63488	61543 81667	58488 77488	43163 ⁸ 49218 ⁷
01-02	Eje Delantero Rígido HD		G63812	
98-00	Crew Cab Pickup Eje Delantero Rígido HD		G63489	61544	58489		G63488	77488
	Eje Delantero Rígido HD		G63812	81668	58812 77489		61543	58488 77488	43163 ⁸ 49218 ⁷
	Extended Cab Pickup Eje Delantero Rígido HD		G63489	61544	58489		G63488	81667	77488
	Standard Cab Pickup Eje Delantero Rígido HD		G63489	61544	58489		81667	77488
92-00	Todos			77488
92-97	Crew Cab Pickup Eje Delantero Rígido HD		G63489	61544	58489 77489		G63488	77488
	Eje Delantero Rígido HD		G63812	81668	58812		61543	58488 77488	43163 ⁸ 49218 ⁷
	Extended Cab Pickup Eje Delantero Rígido HD		G63489	61544	58489 77489		G63488	81667	77488
	Standard Cab Pickup Eje Delantero Rígido HD		G63489	61544	58489 77489		81667	77488

6 Se recomienda que cuando se reemplacen amortiguadores "quad", los 4 sean de la misma serie.

8 Paquetes en pares

80 No requiere soportes para el montaje, instalar sobre montajes de EO Ve a Ref. C para Botas.

7 Paquetes en pares; kit de mangueras de aire incluido

50 Para proteger la barra del pistón, se recomienda utilizar el kit Bellows No.141242.

84 Amortiguador de repuesto para los vehículos con el kit de montaje aftermarket

GRC

AMORTIGUADORES Y STRUTS

Año	Notas de Aplicación	From					Rear				
		Ultra	ProGuard\ Guardian	LTV\ Max Control	Protector de Strut\ Bases de Strut	HiJacker\ Soporte\ Hidráulico	Ultra	ProGuard\ Guardian	LTV\ Max Control	Protector de Strut\ Bases de Strut	HiJacker\ Soporte\ Hidráulico

CHEVROLET

CHEVROLET

PICKUP 1 TON, C35/3500 (cont)

89-91	5.7L MFI	↓	42961 70164	↓
88-91	Cab & Chassis	○	61525 81039	77355	34036 ⁸ 70164	○
	Cab & Chassis Exc. Eje Rígido Delantero HD	○	G63355	58355	70164	○	G63366	61649 81174	58366
73-91	Todos	↓	70164	↓
91	Todos	↓	70164	↓	77488	42958
	Eje Delantero Rígido HD	○	G63812	58812	70164	○	61543	58488	43163 ⁸ 49218 ⁷
	Extended Cab Pickup Eje Delantero Rígido HD	↓	G63489	61544 81668	58489 77489	70164	↓	G63488	81667
	Standard Cab Pickup Eje Delantero Rígido HD	↓	G63489	61544 81668	58489 77489	70164	↓	81667
89-90	Todos	↓	70164	↓	42958
88-90	Extended Cab Pickup Eje Delantero Rígido HD	↓	G63489	61544 81668	58489 77489	70164	↓	G63488	61543 81667	58488 77488	43163 ⁸ 49218 ⁷
	Standard Cab Pickup Eje Delantero Rígido HD	↓	G63489	61544 81668	58489 77489	70164	↓	G63488	61543 81667	58488 77488	43163 ⁸ 49218 ⁷

PICKUP 1 TON, C35/3500 ESTABILIZADORES DE DIRECCIÓN

		Delantero		Trasero	
91-03	Estabilizador de Dirección Sistema Sencillo Pickup HD	6807SE ⁸⁰		

PICKUP 1 TON, K30

77-86	Todos	○	G63411	58411	○	G63675	61642 81921	58412 77412
-------	-------	---	--------	------	-------	------	------	---	--------	----------------	----------------	------	------

PICKUP 1 TON, K30 ESTABILIZADORES DE DIRECCIÓN

		Delantero		Trasero	
77-86	Todos	14017		
	Estabilizador de Dirección Sistema Dual	6802SE ⁸⁴		
	Estabilizador de Dirección Sistema Sencillo	6804SE ⁸⁰		
73-74	Todos	14017		

PICKUP 1 TON, K35 / K3500

88-00	Todos	○	G63609	61542 81726	58609 77609	○	G63488	61543 81667	58488 77488	43163 ⁸ 49218 ⁷
-------	-------	---	--------	----------------	----------------	------	------	---	--------	----------------	----------------	------	--

PICKUP 1 TON, K35 / K3500 ESTABILIZADORES DE DIRECCIÓN

		Delantero		Trasero	
95-00	Exc. Estabilizador de Dirección de EO	6853SE		
88-00	Estabilizador de Dirección Sistema Sencillo	6807SE ⁸⁰		

PICKUP 1 TON, R30

87-88	Todos	○	G63355	61525 81039	58355 77355	34036 ⁸	○	G63366	61649 81174	58366
-------	-------	---	--------	----------------	----------------	------	--------------------	---	--------	----------------	-------	------	------

PICKUP 1 TON, R30 ESTABILIZADORES DE DIRECCIÓN

		Delantero		Trasero	
87-88	Estabilizador de Dirección Sistema Sencillo c/ Cooler	6802SE ⁸⁴		

PICKUP 1 TON, R3500

90-91	Todos	○	G63411	81039	58411	○	G63675	61642 81921	58412 77412
89	Exc. Standard Cab	○	G63411	58411	○	G63675	61642 81921	58412 77412
	Standard Cab Pickup	○	G63355	61525 81039	58355 77355	34036 ⁸	○	G63366	61649 81174	58366





7 Paquetes en pares; kit de mangueras de aire incluido

8 Paquetes en pares

80 No requiere soportes para el montaje, instalar sobre montajes de EO Veá Ref. C para Botas.

84 Amortiguador de repuesto para los vehículos con el kit de montaje aftermarket GRC

AMORTIGUADORES Y STRUTS

Año	Notas de Aplicación										
			Ultra	ProGuard\ Guardian	LTV\ Max Control	Protector de Strut\ Bases de Strut	HiJacker\ Soporte\ Hidráulico		Ultra	ProGuard\ Guardian	LTV\ Max Control





CHEVROLET

CHEVROLET



PICKUP 1 TON, R3500 ESTABILIZADORES DE DIRECCIÓN

							Delantero		Trasero	
89-91	Todos						14017		
		Estabilizador de Dirección Sistema Sencillo c/ Cooler					6802SE ⁸⁴		

PICKUP 1 TON, SILVERADO 3500

11-13	Todos			G64121	58943	
01-09	Todos		G63817	61663 81925	58817 77817		G63675	61642 81921	58412 77412



PICKUP 1 TON, SILVERADO 3500 HD

11-13	Todos		58943	
07-10	Todos		G63817	61663 81925	58817 77817		G63675	61642 81921	58412 77412

PICKUP 1 TON, SILVERADO 3500 HD ESTABILIZADORES DE DIRECCIÓN

							Delantero		Trasero	
11-13	Todos						14075		



PICKUP 1 TON, V30

87-88	Todos		G63411	58411		G63675	61642 81921	58412 77412
-------	-------	---	--------	------	-------	------	------	---	--------	----------------	----------------	------	------

PICKUP 1 TON, V30 ESTABILIZADORES DE DIRECCIÓN

							Delantero		Trasero	
87-88	Todos						14017		

PICKUP 1 TON, V3000 / V3500

89-91	Todos		G63411	58411		G63675	61642 81921	58412 77412
-------	-------	---	--------	------	-------	------	------	---	--------	----------------	----------------	------	------





PICKUP 1 TON, V3000 / V3500 ESTABILIZADORES DE DIRECCIÓN

							Delantero		Trasero	
89-91	Todos						14017		

PICKUP ESTABILIZADORES DE DIRECCIÓN

							Delantero		Trasero	
60	Truck Eje Dana 60 hasta 3 1/2" de Ø ext. o Eje Napco hasta 3 3/8" de Ø ext.						6803SE ⁸⁴		
57-58	Truck Eje Dana 60 hasta 3 1/2" de Ø ext. o Eje Napco hasta 3 3/8" de Ø ext.						6803SE ⁸⁴		
50-58	Truck Estabilizador de Dirección Sistema Sencillo c/ Eje de Viga en I						6802SE ⁸⁴		



PRIZM

98-02	Izquierdo		G55999	143281 ⁵³		G55661
	Derecho		G55999	143281 ⁵³		G55662	142229 ⁵³





PRIZM READYMOUNTS

							Delantero		Trasero	
98-02	Izquierdo						G56948 ⁴⁰		G56949 ⁴⁰	
	Derecho						G56948 ⁴⁰		G56950 ⁴⁰	

PS300

63-72	Todos		70164	
-------	-------	---	------	------	------	------	-------	---	------	------	------	------

S10

99-04	4WD; Exc. ZR2, ZR5 or Sport Chassis		G63423	61531 81516	58423 77423		G63422	61528 81482	58422 77422	43162 ³ 49213 ⁷
88-04	4WD, Barra de Torsion(FrontSpringType)		142316 ⁵³	

7 Paquetes en pares; kit de mangueras de aire incluido

40 Strut ReadyMount. Ensamble Completo



84 Amortiguador de repuesto para los vehículos con el kit de montaje aftermarket GRC

Texto en Negritas - Número de Parte Nuevo / Futuro

8 Paquetes en pares

53 Montaje de Strut. Es probable reutilizar algunas partes del E.O.

AMORTIGUADORES Y STRUTS

Año	Notas de Aplicación										
		Ultra	ProGuard\ Guardian	LTV\ Max Control	Protector de Strut\ Bases de Strut	HiJacker\ Soporte\ Hidráulico	Ultra	ProGuard\ Guardian	LTV\ Max Control	Protector de Strut\ Bases de Strut	HiJacker\ Soporte\ Hidráulico

CHEVROLET

CHEVROLET

S10 (cont)

99-03	RWD; Exc. Sport Chassis or Xtreme Chassis	⊥ ⊕	G63421	61504 81750	58421 77421	34051 ⁸	⊕ ⊖	G63422	61528 81482	58422 77422	43162 ⁸ 49213 ⁷
92-98	4WD; Exc. ZR2, ZR5 or Sport Chassis	⊖	G63423	61531 81516	58423 77423	⊖
	Exc. ZR2, ZR5 or Sport Chassis	⊖	⊕ ⊖	G63422	61528 81482	58422 77422	43162 ⁸ 49213 ⁷
91	RWD; Exc. Sport Chassis or Xtreme Chassis	⊥ ⊕	G63421	61504 81750	58421 77421	34051 ⁸	⊖
	4WD; Exc. ZR2, Baja y Sport Chassis	⊖	G63423	61531 81516	58423 77423	⊖
	Exc. ZR2, Baja y Sport Chassis	⊖	⊕ ⊖	G63422	61528 81482	58422 77422	43162 ⁸ 49213 ⁷
83-90	RWD; Exc. ZR2, Baja y Sport Chassis	⊥ ⊕	G63421	61504 81750	58421 77421	34051 ⁸	⊖
	4WD; Exc. ZR2, ZR5 or Sport Chassis	⊖	G63423	61531 81516	58423 77423	⊖
82-90	Exc. ZR2, ZR5 or Sport Chassis	⊖	⊕ ⊖	G63422	61528 81482	58422 77422	43162 ⁸ 49213 ⁷
	RWD; Exc. Sport Chassis or Xtreme Chassis	⊥ ⊕	G63421	61504 81750	58421 77421	34051 ⁸	⊖

S10 ESTABILIZADORES DE DIRECCIÓN

		Delantero	Trasero
83-04	4WD, Estabilizador de Dirección Sistema Sencillo; con orificio de montaje de EO en brazo de dirección	6801SE
	4WD, Estabilizador de Dirección Sistema Sencillo; sin orificio de montaje de EO en brazo de dirección	6851SE
82-03	RWD, Estabilizador de Dirección Sistema Sencillo	6802SE ⁸⁴

SILVERADO 1500 CLASSIC

07	4WD; Classic y Old Body Style; Exc. Suspensión Electrónica Ajustable	⊥ ⊕	G63803	61643 81922	58803 77803	⊖ ⊕	G63675	61642 81921	77412
	RWD	⊖	⊖	61600
	RWD; Sólo Modelos Classic; Exc. Suspensión Electrónica Ajustable	⊥ ⊕	G63783	61641 81920	58783 77783	⊖	G63662	61600 81873	58662 77662	43181 49235

SONORA

00-06	Exc. Suspensión Z55	⊥ ⊕	G63803	61643 81922	58803 77803	⊖	G63866	61675 81930	58930 77953
-------	---------------------	--------	--------	----------------	----------------	------	------	---	--------	----------------	----------------	------	------

SPARK

11-15	Izquierdo	⊥ ⊕	G52312	⊥ ⊕	70063
	Derecho	⊥ ⊕	G52313	⊥ ⊕	70063

SPECTRUM

85-88	Todos	⊥ ⊕	G55719	⊥ ⊕	81558
-------	-------	--------	--------	------	------	------	------	--------	------	-------	------	------	------

SPRINT

89-91	Todos	⊥ ⊕	G55891	142293 ⁵⁴	⊥ ⊕	G55772	142295 ⁵³
85-88	Todos	⊥ ⊕	G55749	⊥ ⊕

SSR

03-06	Todos	⊥ ⊕	G51718	143241 ⁵³	⊥ ⊕	G63842
-------	-------	--------	--------	------	------	----------------------	------	--------	--------	------	------	------	------

STYLELINE DELUXE

49-52	Todos	⊥ ⊕	82026	⊥ ⊕	82155
-------	-------	--------	------	-------	------	------	------	--------	------	-------	------	------	------

7 Paquetes en pares; kit de mangueras de aire incluido

53 Montaje de Strut. Es probable reutilizar algunas partes del E.O.





84 Amortiguador de repuesto para los vehículos con el kit de montaje aftermarket

GRC

8 Paquetes en pares

54 Kit con Montaje y Rodamiento. Es probable que reutilizar algunas partes del E.O.



AMORTIGUADORES Y STRUTS

Año	Notas de Aplicación										
			Ultra	ProGuard\ Guardian	LTV\ Max Control	Protector de Strut\ Bases de Strut	HiJacker\ Soporte\ Hidráulico		Ultra	ProGuard\ Guardian	LTV\ Max Control





























CHEVROLET

CHEVROLET

STYLELINE SPECIAL

49-52	Todos		82026		82155
-------	-------	---	------	-------	------	------	------	---	------	-------	------	------	------

SUBURBAN 1/2 TON, 1500

14	Todos			G64101	77975
	Exc. Suspensión Z55 o ZW7		G51891		G64101	77975
12-13	Todos			G64101
	Exc. Suspensión Z55 o ZW7		G51891	143316 ⁵³		G64101
09-11	Exc. Suspensión Z55 Auto Ride			58930
	Exc. Suspensión Z55 o ZW7		G51891	143316 ⁵³		G63866	61675 81930	77953
08	Exc. Suspensión Z55 o ZW7		G51891	143316 ⁵³		G63866	61675 81930	58930 77953
07	Exc. Suspensión Z55 Auto Ride			58930
	Exc. Suspensión Z55 o ZW7		G51891	143316 ⁵³		G63866	61675 81930	77953
00-06	Todos			49616
	Exc. Suspensión Z55 Auto Ride		G63803	61643 81922	58803 77803		G63866	61675 81930	58930 77953	43182 49616
63-66	Todos		G63355	61525 81039	58355 77355	34036 ⁸		G63306	82006	43093 ⁸ 49162 ⁷
61-62	Todos		82035		82086
60	Todos			82086











SUBURBAN 1/2 TON, 1500 ESTABILIZADORES DE DIRECCIÓN

		Delantero		Trasero	
00-05	4WD, Exc. Estabilizador de Dirección de EO	6853SE ⁸²		

SUBURBAN 1/2 TON, 1500 READYMOUNTS

		Delantero		Trasero	
07-13	Exc. Suspensión Z55 o ZW7	G57125 ⁴⁰		



SUBURBAN 1/2 TON, C10

87-91	RWD		70164		70165
73-86	Todos		G63355	61525 81039	58355 77355	34036 ⁸		G63349	61524 81164	58349 77349	43111 ⁸ 49155 ⁷
	RWD		G63355	61525 81039	58355 77355	70164 34036 ⁸		G63349	61524 81164	58349 77349	70165 43111 ⁸ 49155 ⁷
68-72	Todos		G63355	61525 81039	58355 77355	34036 ⁸		82003	43062 ⁸ 49107 ⁷
67	Todos		G63355	61525 81039	58355 77355	34036 ⁸		43062 ⁸

SUBURBAN 1/2 TON, C10 ESTABILIZADORES DE DIRECCIÓN

		Delantero		Trasero	
68-86	Estabilizador de Dirección Sistema Sencillo	6802SE ⁸⁴		

SUBURBAN 1/2 TON, C15 / C1500

92-99	Todos		G63489	61544 81668	58489 77489		G63896	61565 81789	58638 77638	43180 ⁸ 49231 ⁷
-------	-------	---	--------	----------------	----------------	------	------	---	--------	----------------	----------------	------	--

7 Paquetes en pares; kit de mangueras de aire incluido
40 Strut ReadyMount. Ensamble Completo
82 Use kit si está señalado. Vea Ref. C para Botas.

8 Paquetes en pares
53 Montaje de Strut. Es probable reutilizar algunas partes del E.O.
84 Amortiguador de repuesto para los vehículos con el kit de montaje aftermarket GRC

Texto en Negritas - Número de Parte Nuevo / Futuro

AMORTIGUADORES Y STRUTS

Año	Notas de Aplicación	Front					Rear				
		Ultra	ProGuard\ Guardian	LTV\ Max Control	Protector de Strut\ Bases de Strut	HiJacker\ Soporte\ Hidráulico	Ultra	ProGuard\ Guardian	LTV\ Max Control	Protector de Strut\ Bases de Strut	HiJacker\ Soporte\ Hidráulico

CHEVROLET

CHEVROLET

SUBURBAN 1/2 TON, C15 / C1500 ESTABILIZADORES DE DIRECCIÓN

		Delantero	Trasero
92-99	RWD	6852SE ⁸²

SUBURBAN 1/2 TON, K10

81-86	Suspensión Estándar; Exc. Kit de Levantamiento	<input type="radio"/> G63347	81113	58347 77355	43107 ⁸	<input type="radio"/>	58349	49155 ⁷
	Suspensión Quad Amortiguador Corto; Exc. Kit de Levantamiento	<input type="radio"/> G63908 ⁶	61516	58908 ⁶ 77355	<input type="radio"/>
	Suspensión Quad Amortiguador Largo; Exc. Kit de Levantamiento	<input type="radio"/> G63906 ⁶	61522 ⁶ 81496 ⁶	58906 ⁶ 77355	<input type="radio"/>
75-86	Exc. Suspensión Quad y Kit de Levantamiento	<input type="radio"/>	77355	<input type="radio"/> G63349	61524 81164	77349	43111 ⁸
73-86	Todos	<input type="radio"/>	77355	<input type="radio"/>
	Con Kit de Levantamiento de 4"; Exc. Suspensión Quad	<input type="radio"/> G63437 ⁵⁰	58437 ⁵⁰ 77355	<input type="radio"/> G63438 ⁵⁰	58438 ⁵⁰
73-80	Exc. Kit de Levantamiento	<input type="radio"/> G63347	61516 81113	58347 77355	43107 ⁸	<input type="radio"/>	58349	49155 ⁷
73-74	Exc. Suspensión Quad y Kit de Levantamiento	<input type="radio"/>	77355	<input type="radio"/> G63349	61524	77349	43111 ⁸
71-72	Todos	<input type="radio"/>	77355	<input type="radio"/> G63371
	Exc. Kit de Levantamiento	<input type="radio"/> G63347	61516 81113	58347 77355	43107 ⁸	<input type="radio"/> G63371
69-70	Exc. Kit de Levantamiento	<input type="radio"/> G63347	61516 81113	58347 77355	43107 ⁸	<input type="radio"/>
68-70	Todos	<input type="radio"/>	77355	<input type="radio"/>

SUBURBAN 1/2 TON, K10 ESTABILIZADORES DE DIRECCIÓN

		Delantero	Trasero
73-86	Todos	14017
	Estabilizador de Dirección Sistema Dual	6802SE ⁸⁴
	Estabilizador de Dirección Sistema Sencillo	6804SE ⁸⁰
68-72	Estabilizador de Dirección Sistema Dual	6802SE ⁸⁴
	Estabilizador de Dirección Sistema Sencillo	6803SE ⁸⁴

SUBURBAN 1/2 TON, K15 / K1500

92-99	Todos	<input type="radio"/> G63609	61542 81726	58609 77609	<input type="radio"/> G63638	61565 81789	58638 77638	43180 ⁶ 49231 ⁷
-------	-------	------------------------------	----------------	----------------	------	------	------------------------------	----------------	----------------	------	--

SUBURBAN 1/2 TON, K15 / K1500 ESTABILIZADORES DE DIRECCIÓN

		Delantero	Trasero
92-97	Estabilizador de Dirección Sistema Sencillo	6807SE ⁸⁰

SUBURBAN 1/2 TON, R10

87-88	Todos	<input type="radio"/> G63355	61525 81039	58355 77355	34036 ⁶	<input type="radio"/> G63349	61524 81164	58349 77349	43111 ⁸ 49155 ⁷
	Exc. Suspensión Quad y Kit de Levantamiento	<input type="radio"/> G63355	61525 81039	58355 77355	43107 ⁸ 34036 ⁶	<input type="radio"/> G63349	61524 81164	58349 77349	43111 ⁸ 49155 ⁷

SUBURBAN 1/2 TON, R10 ESTABILIZADORES DE DIRECCIÓN

		Delantero	Trasero
87-88	Todos	14017
	Estabilizador de Dirección Sistema Dual	6802SE ⁸⁴
	Estabilizador de Dirección Sistema Sencillo	6804SE ⁸⁰

SUBURBAN 1/2 TON, R1500

89-91	Todos	<input type="radio"/> G63355	61525 81039	58355 77355	34036 ⁶	<input type="radio"/> G63349	61524 81164	58349 77349	43111 ⁸ 49155 ⁷
-------	-------	------------------------------	----------------	----------------	------	--------------------	------------------------------	----------------	----------------	------	--

6 Se recomienda que cuando se reemplacen amortiguadores "quad", los 4 sean de la misma serie.

8 Paquetes en pares

80 No requiere soportes para el montaje, instalar sobre montajes de EO Vea Ref. C para Botas.





84 Amortiguador de repuesto para los vehículos con el kit de montaje aftermarket GRC

7 Paquetes en pares; kit de mangueras de aire incluido

50 Para proteger la barra del pistón, se recomienda utilizar el kit Bellows No.141242.

82 Use kit si está señalado. Vea Ref. C para Botas.

AMORTIGUADORES Y STRUTS

Año	Notas de Aplicación										
			Ultra	ProGuard\ Guardian	LTV\ Max Control	Protector de Strut\ Bases de Strut	HiJacker\ Soporte\ Hidráulico		Ultra	ProGuard\ Guardian	LTV\ Max Control



CHEVROLET

CHEVROLET





SUBURBAN 1/2 TON, R1500 ESTABILIZADORES DE DIRECCIÓN

		Delantero					Trasero				
89-91	Estabilizador de Dirección Sistema Sencillo	6802SE ⁸⁴								

SUBURBAN 1/2 TON, V10

87-88	Exc. Suspensión Quad y Kit de Levantamiento	58349
	Suspensión Quad Amortiguador Corto; Exc. Kit de Levantamiento		61516 ⁶ 81113 ⁶
	Suspensión Quad Amortiguador Largo; Exc. Kit de Levantamiento		61522 ⁶ 81496 ⁶

SUBURBAN 1/2 TON, V1500

89-91	Todos	49155 ⁷
	Exc. Kit de Levantamiento	81164	49155 ⁷
	Exc. Suspensión Quad y Kit de Levantamiento		61516	G63349	61524	58349 77349	43111 ⁸ 49155 ⁷
	Suspensión Quad Amortiguador Corto; Exc. Kit de Levantamiento		G63908 ⁶	49155 ⁷
	Suspensión Quad Amortiguador Largo; Exc. Kit de Levantamiento		G63906 ⁶	49155 ⁷
	4WD, Con Kit de Levantamiento de 4"; Exc. Suspensión Quad		G63437 ⁵⁰	58437 ⁵⁰	49155 ⁷







SUBURBAN 3/4 TON, 2500

00-11	Exc. Suspensión Auto Ride Z55 y Quadrasteer		G63817	61663 81925	58817 77817	G63866	61675 81930	58930 77953
-------	---	--	--------	----------------	----------------	------	------	--------	----------------	----------------	------	------

SUBURBAN 3/4 TON, 2500 ESTABILIZADORES DE DIRECCIÓN

		Delantero					Trasero				
00-05	4WD, Exc. Estabilizador de Dirección de EO	6853SE ⁸²								



SUBURBAN 3/4 TON, C20

73-86	Todos		G63355	61525 81039	58355 77355	34036 ⁸		G63349	61524 81164	58349 77349	43111 ⁸ 49155 ⁷
68-72	Todos		G63355	61525 81039	58355 77355	34036 ⁸		82003	43062 ⁸ 49107 ⁷
67	Todos		61525	34036 ⁸	

SUBURBAN 3/4 TON, C20 ESTABILIZADORES DE DIRECCIÓN

		Delantero					Trasero				
68-86	Estabilizador de Dirección Sistema Sencillo	6802SE ⁸⁴								





SUBURBAN 3/4 TON, C25 / C2500

92-99	Todos		G63489	61544 81668	58489 77489		G63896	61565 81789	58638 77638	43180 ⁸ 49231 ⁷
-------	-------	---	--------	----------------	----------------	------	------	---	--------	----------------	----------------	------	--

SUBURBAN 3/4 TON, C25 / C2500 ESTABILIZADORES DE DIRECCIÓN

		Delantero					Trasero				
92-99	RWD	6852SE ⁸²								

SUBURBAN 3/4 TON, K20

81-86	Exc. Kit de Levantamiento	81164
	Suspensión Estándar; Exc. Kit de Levantamiento		G63347	81113	58347	58349	49155 ⁷
	Suspensión Quad Amortiguador Corto; Exc. Kit de Levantamiento		G63908 ⁶	61516	58908 ⁶
	Suspensión Quad Amortiguador Largo; Exc. Kit de Levantamiento		G63906 ⁶	61522 ⁶ 81496 ⁶	58906 ⁶
73-86	Con Kit de Levantamiento de 4"; Exc. Suspensión Quad		G63437 ⁵⁰	58437 ⁵⁰	G63438 ⁵⁰	58438 ⁵⁰

6 Se recomienda que cuando se reemplacen amortiguadores "quad", los 4 sean de la misma serie.

8 Paquetes en pares

82 Use kit si está señalado. Vea Ref. C para Botas.

7 Paquetes en pares; kit de mangueras de aire incluido

50 Para proteger la barra del pistón, se recomienda utilizar el kit Bellows No.141242.

84 Amortiguador de repuesto para los vehículos con el kit de montaje aftermarket

GRC

AMORTIGUADORES Y STRUTS

Año	Notas de Aplicación	From					Rear				
		Ultra	ProGuard\ Guardian	LTV\ Max Control	Protector de Strut\ Bases de Strut	HiJacker\ Soporte\ Hidráulico	Ultra	ProGuard\ Guardian	LTV\ Max Control	Protector de Strut\ Bases de Strut	HiJacker\ Soporte\ Hidráulico

CHEVROLET

CHEVROLET

SUBURBAN 3/4 TON, K20 (cont)

73-86	Exc. Suspensión Quad y Kit de Levantamiento	<input type="radio"/>	77355	<input type="radio"/>	G63349	61524	77349	43111 ⁸
73-80	Exc. Kit de Levantamiento	<input type="radio"/>	G63347	61516 81113	58347	<input type="radio"/>	81164	58349	49155 ⁷
71-72	Exc. Suspensión Quad y Kit de Levantamiento	<input type="radio"/>	77355	<input type="radio"/>	G63371
69-72	Exc. Kit de Levantamiento	<input type="radio"/>	G63347	61516 81113	58347	<input type="radio"/>
68-70	Exc. Suspensión Quad y Kit de Levantamiento	<input type="radio"/>	77355	<input type="radio"/>

SUBURBAN 3/4 TON, K20 ESTABILIZADORES DE DIRECCIÓN

		Delantero			Trasero		
73-86	Todos	14017				
	Estabilizador de Dirección Sistema Dual	6802SE ⁸⁴				
	Estabilizador de Dirección Sistema Sencillo	6804SE ⁸⁰				
68-72	Estabilizador de Dirección Sistema Dual	6802SE ⁸⁴				
	Estabilizador de Dirección Sistema Sencillo	6803SE ⁸⁴				

SUBURBAN 3/4 TON, K25 / K2500

92-99	Todos	<input type="radio"/>	G63609	61542 81726	58609 77609	<input type="radio"/>	G63638	61565 81789	58638 77638	43180 ⁸ 49231 ⁷
-------	-------	-----------------------	--------	----------------	----------------	------	------	-----------------------	--------	----------------	----------------	------	--

SUBURBAN 3/4 TON, K25 / K2500 ESTABILIZADORES DE DIRECCIÓN

		Delantero			Trasero		
95-99	Exc. Estabilizador de Dirección de EO	6853SE ⁸²				
92-97	Estabilizador de Dirección Sistema Sencillo	6807SE ⁸⁰				

SUBURBAN 3/4 TON, R20

87-88	Todos	<input type="radio"/>	G63355	61525 81039	58355 77355	34036 ⁸	<input type="radio"/>	G63349	61524 81164	58349 77349	43111 ⁸ 49155 ⁷
-------	-------	-----------------------	--------	----------------	----------------	------	--------------------	-----------------------	--------	----------------	----------------	------	--

SUBURBAN 3/4 TON, R20 ESTABILIZADORES DE DIRECCIÓN

		Delantero			Trasero		
87-88	Estabilizador de Dirección Sistema Sencillo	6802SE ⁸⁴				

SUBURBAN 3/4 TON, R2500

89-91	Todos	<input type="radio"/>	G63355	61525 81039	58355 77355	34036 ⁸	<input type="radio"/>	G63349	61524 81164	58349 77349	43111 ⁸ 49155 ⁷
-------	-------	-----------------------	--------	----------------	----------------	------	--------------------	-----------------------	--------	----------------	----------------	------	--

SUBURBAN 3/4 TON, R2500 ESTABILIZADORES DE DIRECCIÓN

		Delantero			Trasero		
89-91	Estabilizador de Dirección Sistema Sencillo	6802SE ⁸⁴				

SUBURBAN 3/4 TON, V20

87-88	Todos	<input type="radio"/>	<input type="radio"/>	49155 ⁷
	Con Kit de Levantamiento de 4"; Exc. Suspensión Quad	<input type="radio"/>	G63437 ⁵⁰	58437 ⁵⁰	<input type="radio"/>	G63438 ⁵⁰	58438 ⁵⁰	49155 ⁷
	Exc. Suspensión Quad y Kit de Levantamiento	<input type="radio"/>	G63347	58347	<input type="radio"/>	G63349	61524 81164	58349 77349	43111 ⁸ 49155 ⁷
	Suspensión Quad Amortiguador Corto; Exc. Kit de Levantamiento	<input type="radio"/>	G63908 ⁶	61516 81113 ⁶	58908 ⁶	<input type="radio"/>	49155 ⁷
	Suspensión Quad Amortiguador Largo; Exc. Kit de Levantamiento	<input type="radio"/>	G63906 ⁶	61522 ⁶ 81496 ⁶	58906 ⁶	<input type="radio"/>	49155 ⁷

SUBURBAN 3/4 TON, V20 ESTABILIZADORES DE DIRECCIÓN

		Delantero			Trasero		
87-88	Todos	14017				

6 Se recomienda que cuando se reemplacen amortiguadores "quad", los 4 sean de la misma serie.

8 Paquetes en pares

80 No requiere soportes para el montaje, instalar sobre montajes de EO Vea Ref. C para Botas.





84 Amortiguador de repuesto para los vehículos con el kit de montaje aftermarket GRC

7 Paquetes en pares; kit de mangueras de aire incluido

50 Para proteger la barra del pistón, se recomienda utilizar el kit Bellows No.141242.

82 Use kit si está señalado. Vea Ref. C para Botas.

AMORTIGUADORES Y STRUTS

Año	Notas de Aplicación										
			Ultra	ProGuard\ Guardian	LTV\ Max Control	Protector de Strut\ Bases de Strut	HiJacker\ Soporte\ Hidráulico		Ultra	ProGuard\ Guardian	LTV\ Max Control







CHEVROLET

CHEVROLET

SUBURBAN 3/4 TON, V20 ESTABILIZADORES DE DIRECCIÓN (cont)

		Delantero	Trasero
87-88	Estabilizador de Dirección Sistema Dual	6802SE ⁸⁴
	Estabilizador de Dirección Sistema Sencillo	6804SE ⁸⁰



























SUBURBAN 3/4 TON, V2500

89-91	Todos	49155 ⁷		
	Con Kit de Levantamiento de 4"; Exc. Suspensión Quad	 G63437 ⁵⁰	58437 ⁵⁰	 G63438 ⁵⁰	58438 ⁵⁰	49155 ⁷
	Exc. Suspensión Quad y Kit de Levantamiento	 G63347	58347	 G63349	61524 81164	58349 77349	43111 ⁸ 49155 ⁷
	Suspensión Quad Amortiguador Corto; Exc. Kit de Levantamiento	 G63908 ⁶	61516 81113 ⁶	58908 ⁶	49155 ⁷
	Suspensión Quad Amortiguador Largo; Exc. Kit de Levantamiento	 G63906 ⁶	61522 ⁶ 81496 ⁶	58906 ⁶	49155 ⁷

SUBURBAN 3/4 TON, V2500 ESTABILIZADORES DE DIRECCIÓN

		Delantero	Trasero
89-91	Todos	14017
	Estabilizador de Dirección Sistema Dual	6802SE ⁸⁴
	Estabilizador de Dirección Sistema Sencillo	6804SE ⁸⁰

TAHOE

15	Todos	 G51960	 G64107
12-14	Todos	 G64101	77975
14	Exc. Suspensión Z55 o ZW7	 G51891	 G64101	77975
12-13	Exc. Suspensión Z55 o ZW7	 G51891	143316 ⁵³	 G64101	77975
07-11	Exc. Suspensión Z55 o ZW7	 G51891	143316 ⁵³	 G63866	61675 81930	58930 77953
02-06	Exc. Suspensión Z55 Auto Ride	 G63803	61643 81922	58803 77803		61675 81930	77953	43182 49616
	Exc. Suspensión Z55 o ZW7	 G63866	58930	49616
00-06	Todos		49616
00-01	Estilo New Body, Exc. Suspensión Z55	 G63803	61643 81922	58803 77803	 G63866	61675 81930	58930 77953	49616
	Exc. Suspensión Z55 Auto Ride		43182 49616
00	Old Body Style		61565 81789	58638 77638	43180 ⁸ 49231 ⁷ 49616
	4WD, Old Body Style	 G63609	61542 81726	58901 77609	 G63638	49616
	RWD, Old Body Style	 G63489	61544 81668	58489 77489	 G63896	49616
95-99	Old Body Style		61565 81789	58638 77638	43180 ⁸ 49231 ⁷
	4WD, Old Body Style	 G63609	61542 81726	58901 77609	 G63638
	RWD, Old Body Style	 G63489	61544 81668	58489 77489	 G63896

TAHOE ESTABILIZADORES DE DIRECCIÓN

		Delantero	Trasero
01-05	4WD, Estilo New Body, Exc. Suspensión Z55	6853SE ⁸²
95-00	4WD, Old Body Style	6853SE ⁸²

6 Se recomienda que cuando se reemplacen amortiguadores "quad", los 4 sean de la misma serie.

8 Paquetes en pares

53 Montaje de Strut. Es probable reutilizar algunas partes del E.O.

82 Use kit si está señalado. Vea Ref. C para Botas.

7 Paquetes en pares; kit de mangueras de aire incluido

50 Para proteger la barra del pistón, se recomienda utilizar el kit Bellows No.141242.

80 No requiere soportes para el montaje, instalar sobre montajes de EO Vea Ref. C para Botas.

84 Amortiguador de repuesto para los vehículos con el kit de montaje aftermarket GRC

AMORTIGUADORES Y STRUTS

Año	Notas de Aplicación										
		Ultra	ProGuard\ Guardian	LTV\ Max Control	Protector de Strut\ Bases de Strut	HiJacker\ Soporte\ Hidráulico	Ultra	ProGuard\ Guardian	LTV\ Max Control	Protector de Strut\ Bases de Strut	HiJacker\ Soporte\ Hidráulico

CHEVROLET

CHEVROLET

		TAHOE ESTABILIZADORES DE DIRECCIÓN (cont)					Delantero		Trasero	
95-99	RWD						6852SE ⁸²		

		TAHOE READYMOUNTS					Delantero		Trasero	
07-14	Exc. Suspensión Z55 o ZW7						G57125 ⁴⁰		

TIGRA

99-01	Todos	G35098	56630	69726	42520
-------	-------	--------	------	------	------	-------	-------	------	------	------	-------

TORNADO

11-15	Todos	G52900	G64064
04-10	Izquierdo	G52225	G64064
	Derecho	G52226	G64064

TOWNSMAN

71-72	Todos	69675 ⁵	81446	34073 ⁶	69604	81492
69-70	Todos	69675 ⁵	81446	34073 ⁶	69724	81514	43049 ⁶ 49131 ³⁰

TRACKER

05-08	Izquierdo	G52837	G63799
	Derecho	G52838	G63799
04	Non-ABS	G56518	143204 ⁵³	G63799	61560 81904	49613 ⁷
99-03	Non-ABS	G56518	142294 ⁵⁴ 143204 ⁵³	G63799	61560 81904	49613 ⁷
98	Non-ABS	G56518	142294 ⁵⁴	G63799	61560 81904	49613 ⁷

TRAILBLAZER

06-09	Todos		143241 ⁵³
	Coil(RearSpringType)		143241 ⁵³	G63842	77971
	Exc. Modelo SS	G51718	143241 ⁵³
	Suspensión de Resorte de Aire Trasera		143241 ⁵³	G64014	61717
02-05	Todos	G51718	143241 ⁵³
	Coil(RearSpringType)	G51718	143241 ⁵³	G63842	77971

5 Use el kit 140719 para reemplazar partes del EO de montaje inferior cuando los pernos se rompan o los tornillos autoroscantes no se puedan utilizar más.

8 Paquetes en pares

40 Strut ReadyMount. Ensamble Completo

54 Kit con Montaje y Rodamiento. Es probable que reutilizar algunas partes del E.O.

Texto en Negritas - Número de Parte Nuevo / Futuro





7 Paquetes en pares; kit de mangueras de aire incluido

30 Para Vehículos GM equipados con sistemas de nivelación de fábrica, vea Ref. A.

53 Montaje de Strut. Es probable reutilizar algunas partes del E.O.

82 Use kit si está señalado. Vea Ref. C para Botas.



AMORTIGUADORES Y STRUTS

Año	Notas de Aplicación										
			Ultra	ProGuard\ Guardian	LTV\ Max Control	Protector de Strut\ Bases de Strut	HiJacker\ Soporte\ Hidráulico		Ultra	ProGuard\ Guardian	LTV\ Max Control



CHEVROLET

CHEVROLET

TRAILBLAZER (cont)

02-05	Suspensión de Resorte de Aire Trasera		G51718	143241 ³³		G64014	61717
-------	---------------------------------------	---	--------	------	------	----------------------	------	---	--------	-------	------	------	------

TRAILBLAZER EXT

02-06	Todos		G51718		77971
-------	-------	---	--------	------	------	------	------	---	------	------	-------	------	------







TRAILBLAZER EXT READYMOUNTS

										Delantero	Trasero		
02-06	Todos											G57022 ⁴⁰

TRAILBLAZER READYMOUNTS

										Delantero	Trasero		
06-09	Exc. Modelo SS											G57022
02-05	Todos											G57022





TRAVERSE

15-16	Todos			G64040
13-14	Todos		143486		G64040
09-12	Todos		G52125	143366		G64040





TRAVERSE READYMOUNTS

										Delantero	Trasero		
09-12	Todos											G57109 ⁴⁰









TRAX

13-14	Izquierdo		G52494 ⁴		G511030
	Derecho		G52495 ⁴		G511030

TWO-TEN SERIES

55-57	Todos		69625	82099		82066
53-54	Todos		82026		82155











UPLANDER

05-09	Exc. Suspensión con Nivelación Neumática		G52025	
	FWD		142526 ⁵⁴	
	FWD; Exc. Suspensión con Nivelación Neumática			G63776
05-08	FWD, Suspensión con Nivelación Neumática; Exc. Suspensión Trasera Independiente			49230 ⁷

UPLANDER READYMOUNTS

										Delantero	Trasero		
05-09	FWD											G57142 ³

VAN 1/2 TON, G / EXPRESS

12-14	Todos			77638
	AWD, Barra de Torsion(FrontSpringType)		61683		77638
	RWD, Coil(FrontSpringType)		61684		77638
10-11	Barra de Torsion (FrontSpringType)		61683		G63896	61686 81789	58638 77638	43180 ⁸ 49231 ⁷
07-11	Barra de Torsión (Suspensión de Resorte Delantera)		G63893		G63896	61686 81789	58638 77638	43180 ⁸ 49231 ⁷

3 Número de parte futuro

7 Paquetes en pares; kit de mangueras de aire incluido

40 Strut ReadyMount. Ensamble Completo

54 Kit con Montaje y Rodamiento. Es probable que reutilizar algunas partes del E.O.

Texto en Negritas - Número de Parte Nuevo / Futuro

4 Número de futuro, las cantidades disponibles Q4 2016.

8 Paquetes en pares

53 Montaje de Strut. Es probable reutilizar algunas partes del E.O.

AMORTIGUADORES Y STRUTS

Año	Notas de Aplicación	Front					Rear				
		Ultra	ProGuard\ Guardian	LTV\ Max Control	Protector de Strut\ Bases de Strut	HiJacker\ Soporte\ Hidráulico	Ultra	ProGuard\ Guardian	LTV\ Max Control	Protector de Strut\ Bases de Strut	HiJacker\ Soporte\ Hidráulico

CHEVROLET

CHEVROLET

VAN 1/2 TON, G / EXPRESS (cont)

07-11	Barra de Torsion(FrontSpringType)	U	61683	G63896	61686 81789	58638 77638	43180 ⁶ 49231 ⁷
03-11	Todos		G63896	61686 81789	58638 77638	43180 ⁶ 49231 ⁷
	Exc. Upfitter Package y Cutaway Chassis		G63896	61565 61686 81789	58638 77638	43180 ⁶ 49231 ⁷
	RWD, Coil(FrontSpringType)	U	G63894	61684	G63896	61686 81789	58638 77638	43180 ⁶ 49231 ⁷
03-06	Barra de Torsión (Suspensión de Resorte Delantera)	U	G63893	61683	G63896	61686 81789	58638 77638	43180 ⁶ 49231 ⁷
96-02	Todos	U	G63375 ⁵	61555 81713 ⁵	77375	G63896	61565 81789	58638 77638	43180 ⁶ 49231 ⁷
78-95	Todos	U	G63357	61517 81108	58357 77357	G63413	61522 81496	58413 77413	49212 ⁷
71-77	Todos	U	G63357	61517 81108	58357 77357	G63306	82006	43093 ⁸ 49162 ⁷
70	Todos		G63306	82006	43093 ⁸ 49162 ⁷
	Eje Delantero Rígido		82062	G63306	82006	43093 ⁸ 49162 ⁷
	Suspensión Delantera Independiente	U	G63357	61517 81108	58357 77357	G63306	82006	43093 ⁸ 49162 ⁷
67-69	Todos	U	82062	G63306	82006	43093 ⁸ 49162 ⁷
64-66	Todos	U	82062	82003

VAN 1/2 TON, G / EXPRESS ESTABILIZADORES DE DIRECCIÓN

		Delantero	Trasero
70-95	Estabilizador de Dirección Sistema Sencillo	6802SE ⁸⁴

VAN 1/2 TON, P SERIES

74-80	Todos	U	G63355	61525 81039	58355 77355	34036 ⁶	G63366	61649 81174	58366 77662
73	Todos	U	G63355	61525 81039	58355 77355	34036 ⁶	G63349	61524 81164	58349 77349	43111 ⁶ 49155 ⁷
67-72	Todos	U	G63355	61525 81039	58355 77355	34036 ⁶ 70164	82003	43062 ⁶ 49107 ⁷
63-66	Todos	U	G63355	61525 81039	58355 77355	34036 ⁶ 70164	G63306	82006	43093 ⁸ 49162 ⁷
62	Todos	U	82035	82086

VAN 3/4 TON, G / EXPRESS

10-16	Todos		G63897	61687	77638
	Coil(FrontSpringType)	U	G63895	61685	G63897	61687	77638
10-12	Barra de Torsión (Suspensión de Resorte Delantera)	U	G63893	61683	G63897	61687	77638
	Barra de Torsion (FrontSpringType)	U	61683	G63897	61687	77638
07-09	Todos		G63897	61687 81789	58638 77638
	Barra de Torsión (Suspensión de Resorte Delantera)	U	G63893	61683	G63897	61687 81789	58638 77638
	Coil(FrontSpringType)	U	G63895	61685	G63897	61687 81789	58638 77638
	Barra de Torsion (FrontSpringType)	U	61683	G63897	61687 81789	58638 77638
03-06	Todos		G63897	61687	77638
	Barra de Torsión (Suspensión de Resorte Delantera)	U	G63893	61683	G63897	61687	77638
	Coil(FrontSpringType)	U	G63895	61685	G63897	61687	77638
06	Barra de Torsion (FrontSpringType)	U	61683	G63897	61687	77638



5 Use el kit 140719 para reemplazar partes del EO de montaje inferior cuando los pernos se rompan o los tornillos autoroscantes no se puedan utilizar más.

8 Paquetes en pares

7 Paquetes en pares; kit de mangueras de aire incluido

84 Amortiguador de repuesto para los vehículos con el kit de montaje aftermarket GRC

AMORTIGUADORES Y STRUTS

Año	Notas de Aplicación										
		Ultra	ProGuard\ Guardian	LTV\ Max Control	Protector de Strut\ Bases de Strut	HiJacker\ Soporte\ Hidráulico	Ultra	ProGuard\ Guardian	LTV\ Max Control	Protector de Strut\ Bases de Strut	HiJacker\ Soporte\ Hidráulico

CHEVROLET

CHEVROLET

VAN 3/4 TON, G / EXPRESS (cont)

96-02	Exc. 8600# GVW		77638		
	Exc. PBV 8600 #	I	G63375 ⁵	61555 81713 ⁵	77375	G63638	61565 81789	58638 77638	43180 ⁸ 49231 ⁷
78-95	Todos	O	G63357 ⁵	
	Exc. PBV 8600 #	O	G63357	61517 81108	58357 77357	G63413	61522 81496	58413 77413	49212 ⁷
71-77	Todos	O	G63357	61517 81108	58357 77357	G63306	82006	43093 ⁸ 49162 ⁷
70	Todos	O	58357	G63306	82006	43093 ⁸ 49162 ⁷
	Eje Delantero Rígido	O	82062	58357	G63306	82006	43093 ⁸ 49162 ⁷
	Suspensión Delantera Independiente	O	G63357	61517 81108	77357 58357	G63306	82006	43093 ⁸ 49162 ⁷
67-69	Todos	O	82062	G63306	82006	43093 ⁸ 49162 ⁷

VAN 3/4 TON, G / EXPRESS ESTABILIZADORES DE DIRECCIÓN

		Delantero	Trasero
70-95	Estabilizador de Dirección Sistema Sencillo	6802SE ⁸⁴

VAN 3/4 TON, P SERIES

79-89	Todos	O	G63355	61525 81039	58355 77355	34036 ⁸	O	G63366	61649 81174	58366 77662
73-78	Todos	O	G63355	61525 81039	58355 77355	34036 ⁸	O	G63349	61524 81164	58349 77349	43111 ⁸ 49155 ⁷
68-72	Todos	O	G63355	61525 81039	58355 77355	34036 ⁸ 70164	O	G63306	82006	43093 ⁸ 49162 ⁷
63-72	Todos	I	70164		
63-67	Todos	O	82047	70164		
61-62	Todos	O	82047	I	82155

VAN 1 TON, G / EXPRESS

13-16	Todos		O	G63897	61687	77638
	Coil(FrontSpringType)	I	G63895	61685	G63897	61687	77638
10-12	Todos		O	81789	58638 77638
	Barra de Torsión (Suspensión de Resorte Delantera)	I	G63893	81789	58638 77638
	Rodada Trasera Sencilla		O	G63897	61687 81789	58638 77638
	Single Rear Wheels		O	G63897	61687 81789	58638 77638
	Coil(FrontSpringType)	I	G63895	61685	81789	58638 77638
07-09	Todos		O	77638
	Barra de Torsión (Suspensión de Resorte Delantera)	I	G63893	77638
	Rodada Trasera Sencilla		O	G63897	61687	77638
	Single Rear Wheels		O	G63897	61687	77638
	Coil(FrontSpringType)	I	G63895	61685	77638
03-06	Todos		O	81789	58638 77638
	Barra de Torsión (Suspensión de Resorte Delantera)	I	G63893	81789	58638 77638
	Doble Rodada Trasera		O	G63898	61688 81789	58638 77638

5 Use el kit 140719 para reemplazar partes del EO de montaje inferior cuando los pernos se rompan o los tornillos autoroscantes no se puedan utilizar más.

7 Paquetes en pares; kit de mangueras de aire incluido

84 Amortiguador de repuesto para los vehículos con el kit de montaje aftermarket

8 Paquetes en pares

GRC

AMORTIGUADORES Y STRUTS

Año	Notas de Aplicación	Front					Rear				
		Ultra	ProGuard\ Guardian	LTV\ Max Control	Protector de Strut\ Bases de Strut	HiJacker\ Soporte\ Hidráulico	Ultra	ProGuard\ Guardian	LTV\ Max Control	Protector de Strut\ Bases de Strut	HiJacker\ Soporte\ Hidráulico

CHEVROLET

CHEVROLET

VAN 1 TON, G / EXPRESS (cont)

03-06	Rodada Trasera Sencilla	⊖	G63897	61687 81789	58638 77638
	Single Rear Wheels	⊖	G63897	61687 81789	58638 77638
	Coil(FrontSpringType)	⊖	G63895	61685	81789	58638 77638
97-02	Todos	⊖	G63375 ⁵	61555 81713 ⁵	77375	61565 81789	77638	43180 ⁸ 49231 ⁷
	Exc. PBV 8600 #	⊖	G63375 ⁵	61555 81713 ⁵	77375	G63638	61565 81789	77638	43180 ⁸ 49231 ⁷
96	Todos	⊖	G63357	61517 81108	58357	77638	43180 ⁸ 49231 ⁷
	Exc. PBV 8600 #	⊖	G63357	61517 81108	77375 58357	61565	77638	43180 ⁸ 49231 ⁷
	Cutaway Van	⊖	G63357	61517 81108	58357	G63671	77638	43180 ⁸ 49231 ⁷
92-95	PBV 9200	⊖	G63357	61517 81108	58357 77357	77403
	Cutaway Van	⊖	G63357	61517 81108	58357 77357	G63671	61522 81496	58403	49212 ⁷
	Exc. Cutaway Van	⊖	G63357	61517 81108	58357 77357	G63413
78-95	Todos	⊖	G63357	61517 81108	58357 77357
79-91	PBV 9200	⊖	G63357	61517 81108	58357 77357	G63403	77403
	Cutaway Van	⊖	G63357	61517 81108	58357 77357	61522 81496	58403	49212 ⁷
78-91	Exc. Chassis Cab	⊖	G63357	61517 81108	58357 77357	77413
	Exc. Cutaway Van	⊖	G63357	61517 81108	58357 77357	G63413	58413
78	Cutaway Van	⊖	G63357	61517 81108	58357 77357	61522 81496	49212 ⁷
76-77	Todos	⊖	G63357	81108	G63306	82006	43093 ⁸ 49162 ⁷
75	110.0(WheelBase)	⊖	G63306	82006	43093 ⁸ 49162 ⁷
	125.0(WheelBase)	⊖	G63306	82006	43093 ⁸ 49162 ⁷
	146.0(WheelBase)	⊖	G63357	61517 81108	58357 77357
71-74	Todos	⊖	G63357	61517 81108	58357 77357	G63306	82006	43093 ⁸ 49162 ⁷

VAN 1 TON, G / EXPRESS ESTABILIZADORES DE DIRECCIÓN

		Delantero	Trasero
94-95	Estabilizador de Dirección Sistema Sencillo HD c/ Eje Delantero Rígido y Tilt Hood	6804SE ⁸⁰
71-95	Estabilizador de Dirección Sistema Sencillo	6802SE ⁸⁴

VAN 1 TON, P SERIES

92-99	Todos	⊖	G63366	61649 81174	58366	
	Chasis Motorhome c/ Eje de Viga Delantero en I	⊖	G63625	G63366	61649 81174	58366	
	Chasis Motorhome c/ Suspensión Delantera Independiente	⊖	G63394	58394	G63366	61649 81174	58366	
86-91	Chasis Motorhome c/ Eje de Viga Delantero en I	⊖	G63625	70164	
85-91	Chasis Motorhome c/ Suspensión Delantera Independiente	⊖	G63394	58394	70164	
73-91	Todos	⊖	70164	⊖	G63366	61649 81174	58366

5 Use el kit 140719 para reemplazar partes del EO de montaje inferior cuando los pernos se rompan o los tornillos autoroscantes no se puedan utilizar más.

8 Paquetes en pares

84 Amortiguador de repuesto para los vehículos con el kit de montaje aftermarket GRC

7 Paquetes en pares; kit de mangueras de aire incluido

80 No requiere soportes para el montaje, instalar sobre montajes de EO Vea Ref. C para Botas.

AMORTIGUADORES Y STRUTS

Año	Notas de Aplicación	Front					Rear				
		Ultra	ProGuard\ Guardian	LTV\ Max Control	Protector de Strut\ Bases de Strut	HiJacker\ Soporte\ Hidráulico	Ultra	ProGuard\ Guardian	LTV\ Max Control	Protector de Strut\ Bases de Strut	HiJacker\ Soporte\ Hidráulico

CHEVROLET

CHEVROLET

VAN 1 TON, P SERIES (cont)

63-91	Todos		70164	
73-90	Exc. Chasis Motorhome	O	G63355	61525 81039	58355 77355	34036 ⁸ 70164	
90	5.7L OHC, FI		70164		42958
	5.7L SFI		42961 70164	
89	5.7L OHC, FI		42961 70164		42958
85	Chasis Motorhome c/ Eje de Viga Delantero en I	O	G63403	58403 77403	70164	
75-84	Chasis Motorhome	O	G63394	58394	70164	
74	Chasis Motorhome	O	G63394	58394	70164	
68-72	Todos	O	58355 77355	34036 ⁸ 70164	
	Exc. Chasis Motorhome	O	G63355	61525 81039	70164	
	Exc. Eje Trasero 11,000#		70164	O	G63306	82006	43093 ⁸ 49162 ⁷
63-67	Todos	O	82047	70164	
61-62	Todos	O	82047	82155

VAN 1 TON, P SERIES ESTABILIZADORES DE DIRECCIÓN

		Delantero	Trasero
85-93	Estabilizador de Dirección Sistema Sencillo c/ Suspensión Delantero de Viga en I	6804SE ⁸⁰
75-93	Chasis Motorhome	6805SE ⁸⁰

VECTRA

03-08	Izquierdo		G52044	143290		70005
	Derecho		G52045	143290		70005

VEGA

72-77	Todos	I	82129		81438
71	Todos	I	82129

VENTURE

02-05	Todos		G55948	142524 ⁵⁸ 142525 ⁵³ 142526 ⁵⁴		G63776	61659 81924
	FWD		G55948	142524 ⁵⁸ 142525 ⁵³ 142526 ⁵⁴		G63776	61659 81924	49230 ⁷
97-01	Todos			G63776
	FWD		G55948	142524 ⁵⁸ 142525 ⁵³ 142526 ⁵⁴		G63776	61659 81924	49230 ⁷

VENTURE READYMOUNTS

		Delantero	Trasero
02-05	Todos	G57060⁴⁰
97-01	FWD	G57060⁴⁰

7 Paquetes en pares; kit de mangueras de aire incluido

40 Strut ReadyMount. Ensemble Completo

54 Kit con Montaje y Rodamiento. Es probable que reutilizar algunas partes del E.O.

80 No requiere soportes para el montaje, instalar sobre montajes de EO Vea Ref. C para Botas.

8 Paquetes en pares



53 Montaje de Strut. Es probable reutilizar algunas partes del E.O.

58 El Kit de Montaje incluye: Rodamiento de Suspensión. Es probable reutilizar

algunas partes del E.O.

Texto en Negritas - Número de Parte Nuevo / Futuro

AMORTIGUADORES Y STRUTS

Año	Notas de Aplicación	From 					Rear 				
		Ultra	ProGuard\ Guardian	LTV\ Max Control	Protector de Strut\ Bases de Strut	HiJacker\ Soporte\ Hidráulico	Ultra	ProGuard\ Guardian	LTV\ Max Control	Protector de Strut\ Bases de Strut	HiJacker\ Soporte\ Hidráulico

CHEVROLET ZAFIRA

CHEVROLET

00-07	Izquierdo	G56649
	Derecho	G56650

CHRYSLER 200

CHRYSLER

11-14	Todos	143336 ⁵³	143337 ⁵³
	Izquierdo Suspensión Estándar	G52117	143336 ⁵³	143337 ⁵³
	Derecho Suspensión Estándar	G52118	143336 ⁵³	143337 ⁵³
	Suspensión Estándar	143336 ⁵³	G51863	143337 ⁵³

300

14-16	RWD, Izquierdo Includes Police	G511031
	RWD, Derecho Includes Police	G511032
11-13	Todos	143468 ⁵³
	RWD, Izquierdo Includes Police	G511031	143468 ⁵³
	RWD, Derecho Includes Police	G511032	143468 ⁵³
05-10	Todos	70086	143335 ⁵³
	AWD	G51970	70086	143335 ⁵³
	RWD	143369 ⁵³	70086	143335 ⁵³
	RWD, Izquierdo	G51761	70086	143335 ⁵³
	RWD, Izquierdo Performance Suspensión	G51947	70086	143335 ⁵³
	RWD, Derecho	G51760	70086	143335 ⁵³
	RWD, Derecho Performance Suspensión	G51948	70086	143335 ⁵³
10	Exc. Suspensión Nivomat	G51721 70086	143335 ⁵³
05-09	RWD, Exc. Suspensión Nivomat	G51721 70086	143335 ⁵³
70-71	Todos	82011	43067 ⁸ 49149 ⁷
65-69	Todos	82011	82131	43096 ⁸ 49106 ⁷
57-64	Todos	82072	81469	49110 ⁷

300 READYMOUNTS

		Delantero	Trasero
05-10	RWD, Izquierdo	G57071 ⁴⁰
	RWD, Derecho	G57072 ⁴⁰

7 Paquetes en pares; kit de mangueras de aire incluido

40 Strut ReadyMount. Ensemble Completo





63 El Kit de Montaje incluye: Aislador Parachoques. Es probable reutilizar algunas partes del E.O.

Texto en Negritas - Número de Parte Nuevo / Futuro

8 Paquetes en pares





53 Montaje de Strut. Es probable reutilizar algunas partes del E.O.

AMORTIGUADORES Y STRUTS

Año	Notas de Aplicación										
			Ultra	ProGuard\ Guardian	LTV\ Max Control	Protector de Strut\ Bases de Strut	HiJacker\ Soporte\ Hidráulico		Ultra	ProGuard\ Guardian	LTV\ Max Control

CHRYSLER 300M



CHRYSLER

99-04	Izquierdo		G55663	142827 ⁵⁵		G55856	142828 ⁵³
	Derecho		G55664	142827 ⁵⁵		G55856	142828 ⁵³











300M READYMOUNTS

		Delantero		Trasero	
99-04	Izquierdo	G56962 ⁴⁰		G56964 ⁴⁰	
	Derecho	G56963 ⁴⁰		G56964 ⁴⁰	

ASPEN

07-09	Todos		G64016	61720		G63892
-------	-------	---	--------	-------	------	------	------	---	--------	------	------	------	------









CIRRUS

99-00	Todos			G51268	143328 ⁶³
	J2(Cdigo plataforma del fabricante)		G51267		G51268	143328 ⁶³
97-98	Todos			G51078
	JA(Cdigo plataforma del fabricante)		G51796		G51078
95-96	Todos		G55818		G51078

CIRRUS READYMOUNTS

		Delantero		Trasero	
99-00	Todos		G57025 ⁴⁰	



CONCORDE

98-04	Izquierdo		G55663	142827 ⁵⁵		G55856	142828 ⁵³
	Derecho		G55664	142827 ⁵⁵		G55856	142828 ⁵³
93-97	Izquierdo		G55663	142755 ⁶ 142842 ⁵⁴		G55665
	Derecho		G55664	142755 ⁶ 142842 ⁵⁴		G55665







CONCORDE READYMOUNTS

		Delantero		Trasero	
98-04	Izquierdo	G56962 ⁴⁰		G56964 ⁴⁰	
	Derecho	G56963 ⁴⁰		G56964 ⁴⁰	
93-97	Izquierdo	G56956 ⁴⁰		G56960 ⁴⁰	
	Derecho	G56959 ⁴⁰		G56960 ⁴⁰	

CONQUEST

87-89	Exc. Suspensión Electrónica Ajustable		G44937 ⁹⁸	
-------	---------------------------------------	---	----------------------	------	------	------	------	---	------	------	------	------	------

CORDOBA

80-83	Todos		69704	81406		69703	81338	43138 ⁸
77-79	Todos		81153		69703	81338	43138 ⁸
75-76	Todos		81153		82131	43096 ⁸ 49106 ⁷

6 Se recomienda que cuando se reemplacen amortiguadores "quad", los 4 sean de la misma serie.

8 Paquetes en pares

53 Montaje de Strut. Es probable reutilizar algunas partes del E.O.

55 El Kit de Montaje incluye: Montaje, Asiento de Resorte, Rodamiento y Aislador. Es probable reutilizar algunas partes del E.O.

98 Nota: El nivel de dificultad para instalar este producto es moderadamente alto. Por favor revise las instrucciones cuidadosamente antes de comenzar.

Texto en Negritas - Número de Parte Nuevo / Futuro

7 Paquetes en pares; kit de mangueras de aire incluido

40 Strut ReadyMount. Ensamble Completo

54 Kit con Montaje y Rodamiento. Es probable que reutilizar algunas partes del E.O.

63 El Kit de Montaje incluye: Aislador Parachoques. Es probable reutilizar algunas partes del E.O.

AMORTIGUADORES Y STRUTS

Año	Notas de Aplicación	Front					Rear				
		Ultra	ProGuard\ Guardian	LTV\ Max Control	Protector de Strut\ Bases de Strut	HiJacker\ Soporte\ Hidráulico	Ultra	ProGuard\ Guardian	LTV\ Max Control	Protector de Strut\ Bases de Strut	HiJacker\ Soporte\ Hidráulico

CHRYSLER

CHRYSLER

DART

86-89	2.2L 4Cyl (135) 2BBL	55526	○	69632	81459
83-85	2.2L 4Cyl (135) 2BBL	○	81459
82	Todos	69704	81406	○
	2.2L 4Cyl (135) 2BBL	69704	81406	○	81459
77-81	Todos	69704	81406	○	81338

DART K

86-89	Todos	G55526	○	69632	42459
84-85	Todos	G55511	○	69632	42459
82-83	Todos	G55507	○	69632	42459

DAYTONA

86-93	Todos	G55526	142567 142568 ⁶⁴ 142880 ⁵⁴ 142933 ⁵⁶ 142940 ⁶⁶	○	69632	81459	49369 ⁷
84-85	Todos	G55511	○	69632	81459	49369 ⁷

DYNASTY

88-93	Todos	142880 ⁵⁴ 142933 ⁵⁶	○
	Exc. Sistema de Autonivelación NIVOMAT	142567 142568 ⁶⁴ 142940 ⁶⁶ 142880 ⁵⁴ 142933 ⁵⁶	○
	Sistema Hidráulico de Autonivelación	142880 ⁵⁴ 142933 ⁵⁶	○	81793
	Exc. Sistema de Autonivelación NIVOMAT	G55526	142880 ⁵⁴ 142933 ⁵⁶	○

E CLASS

84	Todos	G55511	○	69632	81459	49369 ⁷
83	Todos	G55507	○	69632	81459	49369 ⁷

EXECUTIVE LIMOUSINE

85	Todos	G55511	○	69632	81459	49369 ⁷
----	-------	-------	--------	-------	-------	-------	-------	---	-------	-------	-------	-------	--------------------

EXECUTIVE SEDAN

84	Todos	G55511	○	69632	81459	49369 ⁷
83	Todos	G55507	○	69632	81459	49369 ⁷

FIFTH AVENUE

90-93	Todos	○	69632	81459
83-89	Todos	69704	81406	○	69703	81338	43138 ⁸ 49346 ⁷

7 Paquetes en pares; kit de mangueras de aire incluido

54 Kit con Montaje y Rodamiento. Es probable que reutilizar algunas partes del E.O.

64 El Kit de Montaje incluye: Aislador de Goma del Asiento de Resorte. Es probable reutilizar algunas partes del E.O.

8 Paquetes en pares

56 El Kit de Montaje incluye: Montaje, Parachoques y Retenedores. Es probable reutilizar algunas partes del E.O.

66 Asiento de Resorte Superior con Espaciador. Es probable reutilizar algunas partes del E.O.

AMORTIGUADORES Y STRUTS

Año	Notas de Aplicación	Front					Rear				
		Ultra	ProGuard\ Guardian	LTV\ Max Control	Protector de Strut\ Bases de Strut	HiJacker\ Soporte\ Hidráulico	Ultra	ProGuard\ Guardian	LTV\ Max Control	Protector de Strut\ Bases de Strut	HiJacker\ Soporte\ Hidráulico

CHRYSLER

IMPERIAL

90-93	Todos	142567 ⁶ 142880 ⁵⁴ 142933 ⁵⁶	
	Exc. Sistema de Autonivelación NIVOMAT	142567 ⁶ 142568 ⁵⁴ 142940 ⁵⁶ 142567 ⁶ 142880 ⁵⁴ 142933 ⁵⁶	69632	81459	49369 ⁷	
	Exc. Sistema de Autonivelación NIVOMAT	G55526	142567 ⁶ 142880 ⁵⁴ 142933 ⁵⁶	
81-83	Todos	I	69704	81406	O	69703	81338	43138 ⁸ 49346 ⁷
74-75	Todos	I	69704	81406	O	82131	43096 ⁸ 49106 ⁷
67-73	Todos	O	82011	O	81091	43067 ⁸ 49149 ⁷
57-66	Todos	O	82072	O	81469
55	Todos	O	O	81469

CHRYSLER

IMPERIAL READYMOUNTS

		Delantero	Trasero
90-93	Exc. Sistema de Autonivelación NIVOMAT	G56985 ⁴⁰

INTREPID

98-04	Izquierdo	G55663	142827 ⁵⁵	G55856	142828 ⁵³
	Derecho	G55664	142827 ⁵⁵	G55856	142828 ⁵³
93-97	Izquierdo	G55663	142842 ⁵⁴	G55665
	Derecho	G55664	142842 ⁵⁴	G55665

INTREPID READYMOUNTS

		Delantero	Trasero
98-04	Izquierdo	G56962 ⁴⁰
	Derecho	G56963 ⁴⁰

LASER

86	Todos	G55526	142567 ⁶ 142568 ⁵⁴ 142880 ⁵⁴ 142933 ⁵⁶	69632	81459	49369 ⁷
	Fab. desde 02/Enero/86	G55526	142940 ⁵⁶ 142567 ⁶ 142568 ⁵⁴ 142880 ⁵⁴ 142933 ⁵⁶	69632	81459	49369 ⁷
84-85	Todos	G55511	69632	81459	49369 ⁷

LEBARON

89-95	2.2L 4Cyl	55526
87-95	Todos	G55526	142567 ⁶ 142568 ⁵⁴ 142880 ⁵⁴ 142933 ⁵⁶ 142940 ⁵⁶	69632	81459	49369 ⁷

6 Se recomienda que cuando se reemplacen amortiguadores "quad", los 4 sean de la misma serie.

8 Paquetes en pares

53 Montaje de Strut. Es probable reutilizar algunas partes del E.O.

55 El Kit de Montaje incluye: Montaje, Asiento de Resorte, Rodamiento y Aislador. Es probable reutilizar algunas partes del E.O.

64 El Kit de Montaje incluye: Aislador de Goma del Asiento de Resorte. Es probable reutilizar algunas partes del E.O.

7 Paquetes en pares; kit de mangueras de aire incluido

40 Strut ReadyMount. Ensamble Completo

54 Kit con Montaje y Rodamiento. Es probable que reutilizar algunas partes del E.O.

56 El Kit de Montaje incluye: Montaje, Parachoques y Retenedores. Es probable reutilizar algunas partes del E.O.

66 Asiento de Resorte Superior con Espaciador. Es probable reutilizar algunas partes del E.O.

Texto en Negritas - Número de Parte Nuevo / Futuro

AMORTIGUADORES Y STRUTS

Año	Notas de Aplicación	Front					Rear				
		Ultra	ProGuard\ Guardian	LTV\ Max Control	Protector de Strut\ Bases de Strut	HiJacker\ Soporte\ Hidráulico	Ultra	ProGuard\ Guardian	LTV\ Max Control	Protector de Strut\ Bases de Strut	HiJacker\ Soporte\ Hidráulico

CHRYSLER

CHRYSLER

LEBARON (cont)

86-88	2.2L 4Cyl	↓	55526	↓	42459
86	Todos	↓	G55526	142567 ⁶ 142568 ⁶⁴ 142880 ⁵⁴ 142933 ⁵⁶	↓	69632	81459	49369 ⁷
	Fab. desde 02/Enero/86	↓	G55526	142940 ⁶⁶ 142567 ⁶ 142568 ⁶⁴ 142880 ⁵⁴ 142933 ⁵⁶	↓	69632	81459	49369 ⁷
84-85	Todos	↓	G55511	↓	69632	81459	49369 ⁷
83	Todos	↓	G55507	↓	69632	81459	49369 ⁷
82	Todos	↓	69704	81406	↓	69632	81459	49369 ⁷
81	Todos	↓	69704	81406	↓	69632	81338	43138 ⁸
	Carrocería M	↓	69704	81406	↓	69632	81338	49346 ⁷ 43138 ⁸
	Exc. Carrocería M	↓	69704	81406	↓	69632	81338	49369 ⁷ 43138 ⁸
	Exc. M Body	↓	69704	81406	↓	69632	81459 81338	43138 ⁸
77-80	Todos	↓	69704	81406	↓	69703	81338	43138 ⁸
	Carrocería M	↓	69704	81406	↓	69703	81338	49346 ⁷ 43138 ⁸

LEBARON K

86-89	Todos	↓	55526	↓
-------	-------	---	-------	-------	-------	-------	-------	---	-------	-------	-------	-------	-------

LEBARON READYMOUNTS

										Delantero	Trasero		
89-94	Todos											G56985 ⁴⁰

LHS

99-01	Izquierdo	↓	G55663	142827 ⁵⁵	↓	G55856	142828 ⁵³
	Derecho	↓	G55664	142827 ⁵⁵	↓	G55856	142828 ⁵³
94-97	Izquierdo	↓	G55663	142755 ⁶ 142842 ⁵⁴	↓	G55665
	Derecho	↓	G55664	142755 ⁶ 142842 ⁵⁴	↓	G55665

LHS READYMOUNTS

										Delantero	Trasero		
99-01	Izquierdo											G56962 ⁴⁰	G56964 ⁴⁰
	Derecho											G56963 ⁴⁰	G56964 ⁴⁰
94-97	Izquierdo											G56958 ⁴⁰
	Derecho											G56959 ⁴⁰

MAGNUM

77-82	Todos	↓	69704	81406	↓	81338
-------	-------	---	-------	-------	-------	-------	-------	---	-------	-------	-------	-------	-------

6 Se recomienda que cuando se reemplacen amortiguadores "quad", los 4 sean de la misma serie.

8 Paquetes en pares

53 Montaje de Strut. Es probable reutilizar algunas partes del E.O.

55 El Kit de Montaje incluye: Montaje, Asiento de Resorte, Rodamiento y Aislador. Es probable reutilizar algunas partes del E.O.

64 El Kit de Montaje incluye: Aislador de Goma del Asiento de Resorte. Es probable reutilizar algunas partes del E.O.

7 Paquetes en pares; kit de mangueras de aire incluido

40 Strut ReadyMount. Ensemble Completo





54 Kit con Montaje y Rodamiento. Es probable que reutilizar algunas partes del E.O.

56 El Kit de Montaje incluye: Montaje, Parachoques y Retenedores. Es probable reutilizar algunas partes del E.O.

66 Asiento de Resorte Superior con Espaciador. Es probable reutilizar algunas partes del E.O.

Texto en Negritas - Número de Parte Nuevo / Futuro







AMORTIGUADORES Y STRUTS

Año	Notas de Aplicación										
			Ultra	ProGuard\ Guardian	LTV\ Max Control	Protector de Strut\ Bases de Strut	HiJacker\ Soporte\ Hidráulico		Ultra	ProGuard\ Guardian	LTV\ Max Control



CHRYSLER

CHRYSLER





MAGNUM K

86-89	Todos		G55526	55526		69632	81459	42459 49369
84-85	Todos		G55511		69632	81459	49369
82-83	Todos		G55507		69632	81459	49369

NASSAU

55-56	Todos			81469	49110 ⁷
-------	-------	---	------	------	------	------	------	---	------	-------	------	------	--------------------



























NEON

00-02	Izquierdo		G55892	142932 ⁵⁵		G55894	143256 ⁵³
	Derecho		G55892	142932 ⁵⁵		G55893	143256 ⁵³

NEON READYMOUNTS

		Delantero		Trasero	
00-02	Izquierdo	G56975 ⁴⁰		G56973 ⁴⁰	
	Derecho	G56975 ⁴⁰		G56974 ⁴⁰	

NEW YORKER

94-96	Izquierdo		G55663	142755 ⁶ 142842 ⁵⁴		G55665
	Derecho		G55664	142755 ⁶ 142842 ⁵⁴		G55665
92-93	3L 2BBL		55526		42459
89-93	Todos		G55526	142567 ⁶ 142568 ⁵⁴ 142880 ⁵⁴ 142933 ⁵⁶ 142940 ⁶⁶		42459
	2.2L 4Cyl		55526		42459
88-93	Exc. Sistema de Autonivelación NIVOMAT			69632	81459	49369 ⁷ 42459
85-93	Todos			42459
88	Todos		G55526	142567 ⁶ 142568 ⁵⁴ 142880 ⁵⁴ 142933 ⁵⁶ 142940 ⁶⁶	55526		42459
87	Todos		G55526	142567 ⁶ 142568 ⁵⁴ 142880 ⁵⁴ 142933 ⁵⁶ 142940 ⁶⁶	55526		69632	81459	49369 ⁷ 42459
86	Todos		G55526	142567 ⁶ 142568 ⁵⁴ 142880 ⁵⁴ 142933 ⁵⁶	55526		69632	81459	49369 ⁷ 42459
	Fab. desde 02/Enero/86		142940 ⁶⁶		42459
85	Todos		G55511		69632	81459	49369 ⁷ 42459
84	Todos		G55511		69632	81459	49369 ⁷

6 Se recomienda que cuando se reemplacen amortiguadores "quad", los 4 sean de la misma serie.

40 Strut ReadyMount. Ensemble Completo

54 Kit con Montaje y Rodamiento. Es probable que reutilizar algunas partes del E.O.

56 El Kit de Montaje incluye: Montaje, Parachoques y Retenedores. Es probable reutilizar algunas partes del E.O.

66 Asiento de Resorte Superior con Espaciador. Es probable reutilizar algunas partes del E.O.

7 Paquetes en pares; kit de mangueras de aire incluido

53 Montaje de Strut. Es probable reutilizar algunas partes del E.O.

55 El Kit de Montaje incluye: Montaje, Asiento de Resorte, Rodamiento y Aislador. Es probable reutilizar algunas partes del E.O.

64 El Kit de Montaje incluye: Aislador de Goma del Asiento de Resorte. Es probable reutilizar algunas partes del E.O.

Texto en Negritas - Número de Parte Nuevo / Futuro

AMORTIGUADORES Y STRUTS

Año	Notas de Aplicación	From					Rear				
		Ultra	ProGuard\ Guardian	LTV\ Max Control	Protector de Strut\ Bases de Strut	HiJacker\ Soporte\ Hidráulico	Ultra	ProGuard\ Guardian	LTV\ Max Control	Protector de Strut\ Bases de Strut	HiJacker\ Soporte\ Hidráulico

CHRYSLER

CHRYSLER

NEW YORKER (cont)

83	Todos	↓	G55507	○	69632	81459	49369 ⁷
79-82	Todos	↓	69704	81406	○	69703	81338	43138 ⁸
74-78	Todos	↓	69704	81406	○	82131	43096 ⁸ 49106 ⁷
70-73	Todos	↓	82011	○	81091	43067 ⁸ 49149 ⁷
65-69	Todos	↓	82011	○	82131	43096 ⁸ 49106 ⁷
57-64	Todos	↓	82072	○	81469	49110 ⁷
51-56	Todos	↓	○	81469	49110 ⁷

NEW YORKER READYMOUNTS

		Delantero	Trasero
94-96	Izquierdo	G56958 ⁴⁰
	Derecho	G56959 ⁴⁰
90-93	Exc. Sistema de Autonivelación NIVOMAT	G56985 ⁴⁰

NEWPORT

79-81	Todos	↓	81153	○	69703	81338	43138 ⁸
74-78	Todos	↓	69704	81406	○	82131	43096 ⁸ 49106 ⁷
70-73	Todos	↓	82011	○	81091	43067 ⁸ 49149 ⁷
65-69	Todos	↓	82011	○	82131	43096 ⁸ 49106 ⁷
57-64	Todos	↓	82072	○	81469	49110 ⁷
51-56	Todos	↓	○	81469	49110 ⁷

PACIFICA

04-08	Todos	↓	G56772	142931 ⁵⁴	○
-------	-------	---	--------	------	------	----------------------	------	---	------	------	------	------	------

PACIFICA READYMOUNTS

		Delantero	Trasero
07-08	Izquierdo	G57112
	Derecho	G57113
04-06	Izquierdo	G57112 ⁴⁰
	Derecho	G57113 ⁴⁰

PHANTOM

91-94	2.5L y 2.2L; 4cyl 2.5L RWD; 2BBL	↓	○	42459
86-94	2.5L y 2.2L; 4cyl RWD; 2BBL	↓	55526	○	69632	81459
87-90	2BBL 2.5L	↓	○	42459
90	2.5L y 2.2L; 4cyl 2.2L RWD; 2BBL	↓	○	42459
87-89	2BBL 2.2L	↓	○	42459

PT CRUISER

01-10	Todos	↓	G55896	142932 ⁵⁵	○	69473
-------	-------	---	--------	------	------	----------------------	------	---	-------	------	------	------	------

PT CRUISER READYMOUNTS

		Delantero	Trasero
01-10	Todos	G56965 ⁴⁰

7 Paquetes en pares; kit de mangueras de aire incluido

40 Strut ReadyMount. Ensemble Completo



55 El Kit de Montaje incluye: Montaje, Asiento de Resorte, Rodamiento y Aislador. Es probable reutilizar algunas partes del E.O.

Texto en Negritas - Número de Parte Nuevo / Futuro

8 Paquetes en pares

54 Kit con Montaje y Rodamiento. Es probable que reutilizar algunas partes del E.O.





AMORTIGUADORES Y STRUTS

Año	Notas de Aplicación	Front					Rear				
			Ultra	ProGuard\ Guardian	LTV\ Max Control	Protector de Strut\ Bases de Strut	HiJacker\ Soporte\ Hidráulico		Ultra	ProGuard\ Guardian	LTV\ Max Control





























CHRYSLER

SARATOGA

CHRYSLER

57-60	Todos		82072		81469	49110 ⁷
51-52	Todos			81469	49110 ⁷







SEBRING

08-10	Izquierdo		G52117	143336 ⁵³		G51863	143337 ⁵³
	Derecho		G52118	143336 ⁵³		G51863	143337 ⁵³
07	Todos		143336 ⁵³		G51863	143337 ⁵³
03-06	Sedan y Convertible ; JR (Cdigo plataforma del fabricante)		G51267	143423		G51268	143423
01-06	Sedan, JR(Cdigo plataforma del fabricante)			143321 ⁵³
01-05	Coupe, ST(Cdigo plataforma del fabricante) Izquierdo		G56552	143087 ⁵³		G51254	142419 ⁵³
	Coupe, ST(Cdigo plataforma del fabricante) Derecho		G56551	143087 ⁵³		G51254	142419 ⁵³
01-02	Sedan y Convertible ; JR (Cdigo plataforma del fabricante)		G51267		G51268	143423
99-00	Sedan y Convertible ; JR (Cdigo plataforma del fabricante)		G51267		G51268
96-00	Coupe		G55820	142419 ⁵³		G51254	142419 ⁵³
97-98	Convertible		G51796		G51078
96	Convertible		G55818		G51078
95	Todos		142419 ⁵³		142419 ⁵³
	Coupe		G55820	142419 ⁵³		G51254	142419 ⁵³





SEBRING READYMOUNTS

		Delantero	Trasero
01-06	Sedan, JR(Cdigo plataforma del fabricante)	G57026 ⁴⁰
01-05	Coupe, ST(Cdigo plataforma del fabricante) Izquierdo	G57073 ⁴⁰	G57075 ⁴⁰
	Coupe, ST(Cdigo plataforma del fabricante) Derecho	G57074 ⁴⁰	G57075 ⁴⁰



SHADOW

88-94	Todos		G55526	
	2.5L 2BBL		G55526		42459
	2.5L y 2.2L; 4cyl RWD; 2BBL		G55526	55526		69632	81459



SPIRIT RT

89-95	2.5L 2BBL			42459
	2.5L 4Cyl (153) RWD; 2BBL		55526		69632	81459

ST REGIS

55-56	Todos			81469	49110 ⁷
-------	-------	---	------	------	------	------	------	---	------	-------	------	------	--------------------

TOWN & COUNTRY

13-16	Exc. Suspensión Autonivelable		143463 ⁵³		G64042
-------	-------------------------------	---	------	------	------	-----------------------------	------	---	--------	------	------	------	------

7 Paquetes en pares; kit de mangueras de aire incluido

40 Strut ReadyMount. Ensemble Completo

53 Montaje de Strut. Es probable reutilizar algunas partes del E.O.

Texto en Negritas - Número de Parte Nuevo / Futuro

AMORTIGUADORES Y STRUTS

Año	Notas de Aplicación	From					Rear				
		Ultra	ProGuard\ Guardian	LTV\ Max Control	Protector de Strut\ Bases de Strut	HiJacker\ Soporte\ Hidráulico	Ultra	ProGuard\ Guardian	LTV\ Max Control	Protector de Strut\ Bases de Strut	HiJacker\ Soporte\ Hidráulico

CHRYSLER

CHRYSLER

TOWN & COUNTRY (cont)

13-16	Exc. Modelo S	G52131	143463 ⁵³
08-16	Todos	143463 ⁵³
08-12	Exc. Suspensión Autonivelable	G52131	143463 ⁵³	G64042
01-07	Todos	G56620	142931 ⁵⁴	61605 ³⁴ 81878	49236 ⁷ 43186
96-07	Exc. Sistema de Autonivelación NIVOMAT	G63690 ¹⁰	43186
95-07	Todos	43186
96-00	Todos	G55697	142753 ⁶ 142841 ⁵⁴	61605 ³⁴ 81878	49236 ⁷ 43186
95	Todos	G55525	142567 ⁶ 142568 ⁶⁴ 142880 ⁵⁴ 142933 ⁵⁶ 142940 ⁶⁶	G63426	61538 81529	43186
90-94	Todos	G55525	142567 ⁶ 142568 ⁶⁴ 142880 ⁵⁴ 142933 ⁵⁶ 142940 ⁶⁶	G63426	61538 81529
86-88	Todos	G55526	142567 ⁶ 142568 ⁶⁴ 142880 ⁵⁴	G69632	81459	49369 ⁷
79-81	Todos	81153	G69703	81338	43138 ⁸
74-78	Todos	G69704	81406	82131	43096 ⁸ 49106 ⁷
71-73	Todos	82011	81091	43067 ⁸ 49149 ⁷
65-70	Todos	82011	82131	43096 ⁸ 49106 ⁷
57-64	Todos	82072	81469	49110 ⁷
51-56	Todos	81469	49110 ⁷

TOWN & COUNTRY READYMOUNTS

		Delantero	Trasero
08-10	Todos	G57206 ¹⁰
01-07	Izquierdo	G56956 ¹⁰
	Derecho	G56957 ¹⁰
96-00	Todos	G56910 ¹⁰
90-95	Todos	G56907 ¹⁰

VOLARE

86-89	3.7L 6Cyl (225) RWD; 4BBL	55526	G69632	81459	42459
-------	---------------------------	------	------	------	-------	--------	-------	------	------	-------

VOYAGER / GRAND VOYAGER

08	Todos	G63690
04-07	Todos	G56620	142931 ⁵⁴	G63690
01-03	Exc. Sistema de Autonivelación NIVOMAT	61605 ³⁴ 81878	49236 ⁷ 43186

6 Se recomienda que cuando se reemplacen amortiguadores "quad", los 4 sean de la misma serie.

8 Paquetes en pares

34 Si el resorte toca el amortiguador, gire el resorte 180°.

53 Montaje de Strut. Es probable reutilizar algunas partes del E.O.

56 El Kit de Montaje incluye: Montaje, Parachoques y Retenedores. Es probable reutilizar algunas partes del E.O.

66 Asiento de Resorte Superior con Espaciador. Es probable reutilizar algunas partes del E.O.

Texto en Negritas - Número de Parte Nuevo / Futuro

7 Paquetes en pares; kit de mangueras de aire incluido

10 Los amortiguadores NIVOMAT son para aplicación trasera únicamente. Si los resortes tocan los amortiguadores, gírelos 180°.

40 Strut ReadyMount. Ensamble Completo

54 Kit con Montaje y Rodamiento. Es probable que reutilizar algunas partes del E.O.

64 El Kit de Montaje incluye: Aislador de Goma del Asiento de Resorte. Es probable reutilizar algunas partes del E.O.

AMORTIGUADORES Y STRUTS

Año	Notas de Aplicación	Front					Rear				
		Ultra	ProGuard\ Guardian	LTV\ Max Control	Protector de Strut\ Bases de Strut	HiJacker\ Soporte\ Hidráulico	Ultra	ProGuard\ Guardian	LTV\ Max Control	Protector de Strut\ Bases de Strut	HiJacker\ Soporte\ Hidráulico

CHRYSLER

CHRYSLER

VOYAGER / GRAND VOYAGER (cont)

01-03	Non-ABS Exc. Sistema de Autonivelación NIVOMAT	○	G63690 ¹⁰	43186
00-03	Todos	○	43186
03	Todos	↓	G56620	142931 ⁵⁴	43186
01-02	Todos	↓	G56620	142931 ⁵⁴	G63690	43186
01	3.3L 6Cyl (201) RWD; 4BBL	○	61538	43186
00	Todos	↓	G55697	142753 ⁶ 142841 ⁵⁴	G63690	61605 ³⁴ 81878	49236 ⁷ 43186
	Non-ABS	↓	G55697	81878	43186
	Non-ABS Exc. Sistema de Autonivelación NIVOMAT	G63690 ¹⁰	61605 ³⁴	43186
96-99	Todos	○	G63690	61605 ³⁴ 81878
95	Todos	○	G63690
	3.8L 6Cyl (231) RWD; MFI	○	G63690	61538 81529
93-94	3.3L 6Cyl (201) RWD; 4BBL	○	61538 81529
91-94	3.8L 6Cyl (231) RWD; MFI	○	61538 81529
90-94	2.5L 4Cyl (153) RWD; 2BBL	○	61538 81529

VOYAGER / GRAND VOYAGER READYMOUNTS

		Delantero		Trasero	
01-07	Izquierdo	G56956 ⁴⁰		
	Derecho	G56957 ⁴⁰		
00	Todos	G56910 ⁴⁰		
	Exc. Sistema de Autonivelación NIVOMAT	G56910 ⁴⁰		

WINDSOR

57-61	Todos	○	82072	○	81469	49110 ⁷
51-56	Todos	○	○	81469	49110 ⁷

DAEWOO

DAEWOO

LANOS

99-02	Todos	↓	G44903 ⁹⁸	○	69749
-------	-------	---	----------------------	-------	-------	-------	-------	---	-------	-------	-------	-------	-------

LEGANZA

99-02	Izquierdo	↓	G56762	↓	G56764
	Derecho	↓	G56762	↓	G56763

NUBIRA

99-02	Non-ABS Derecho	↓	G56765	↓	G56767
-------	-----------------	---	--------	-------	-------	-------	-------	---	--------	-------	-------	-------	-------

6 Se recomienda que cuando se reemplacen amortiguadores "quad", los 4 sean de la misma serie.

10 Los amortiguadores NIVOMAT son para aplicación trasera únicamente. Si los resortes tocan los amortiguadores, gírelos 180°.

40 Strut ReadyMount. Ensemble Completo

98 Nota: El nivel de dificultad para instalar este producto es moderadamente alto. Por favor revise las instrucciones cuidadosamente antes de comenzar.

Texto en Negritas - Número de Parte Nuevo / Futuro

7 Paquetes en pares; kit de mangueras de aire incluido

34 Si el resorte toca el amortiguador, gire el resorte 180°.

54 Kit con Montaje y Rodamiento. Es probable que reutilizar algunas partes del E.O.

AMORTIGUADORES Y STRUTS

Año	Notas de Aplicación	Front					Rear				
		Ultra	ProGuard\ Guardian	LTV\ Max Control	Protector de Strut\ Bases de Strut	HiJacker\ Soporte\ Hidráulico	Ultra	ProGuard\ Guardian	LTV\ Max Control	Protector de Strut\ Bases de Strut	HiJacker\ Soporte\ Hidráulico

DAIHATSU

DAIHATSU

CHARADE

88-92	Todos	142626 ⁵³
-------	-------	-------	-------	-------	-------	-------	-------	-------	-------	-------	-------	----------------------	-------

ROCKY

90-92	Todos	G63611	81872
-------	-------	--------	-------	-------	-------	-------	-------	-------	-------	-------	-------	-------	-------

DODGE

DODGE

330

63-64	Todos	82090	49106 ⁷
-------	-------	-------	-------	-------	-------	-------	-------	-------	-------	-------	-------	-------	--------------------

400

82-83	Todos	G55507	49369 ⁷
-------	-------	--------	-------	-------	-------	-------	-------	-------	-------	-------	-------	-------	--------------------

440

63-64	Todos	82090	49106 ⁷
-------	-------	-------	-------	-------	-------	-------	-------	-------	-------	-------	-------	-------	--------------------

600

88	Todos	G55526	142567 142568 ⁶⁴ 142880 ⁵⁴ 142933 ⁵⁶ 142940 ⁶⁶	49369 ⁷
87	Todos	G55526	142567 142568 ⁶⁴ 142880 ⁵⁴ 142933 ⁵⁶	49369 ⁷
	Fab. desde 02/Enero/86	G55526	142940 ⁶⁶ 142567 142568 ⁶⁴ 142880 ⁵⁴ 142933 ⁵⁶	49369 ⁷
86	Todos	G55526	142567 142568 ⁶⁴ 142880 ⁵⁴ 142933 ⁵⁶	49369 ⁷
	Fab. desde 02/Enero/86	G55526	142940 ⁶⁶ 142567 142568 ⁶⁴ 142880 ⁵⁴ 142933 ⁵⁶	49369 ⁷
	Fab. hasta 2/86	G55526	142567 142568 ⁶⁴ 142880 ⁵⁴ 142933 ⁵⁶	49369 ⁷
84-85	Todos	G55511	49369 ⁷
83	Todos	G55507	49369 ⁷

880

65	Todos	82011	43096 ⁶ 49106 ⁷
62-64	Todos	82072	49110 ⁷

2000 GTX

89-90	Todos	G55945
90	Exc. Sistema de Autonivelación	G55945	142219 ⁵³
89	Exc. Sistema de Autonivelación	G55945	142219 ⁵³	142419 ⁵³

7 Paquetes en pares; kit de mangueras de aire incluido

53 Montaje de Strut. Es probable reutilizar algunas partes del E.O.

56 El Kit de Montaje incluye: Montaje, Parachoques y Retenedores. Es probable reutilizar algunas partes del E.O.



66 Asiento de Resorte Superior con Espaciador. Es probable reutilizar algunas partes del E.O.

8 Paquetes en pares

54 Kit con Montaje y Rodamiento. Es probable que reutilizar algunas partes del E.O.

64 El Kit de Montaje incluye: Aislador de Goma del Asiento de Resorte. Es probable reutilizar algunas partes del E.O.

AMORTIGUADORES Y STRUTS

Año	Notas de Aplicación										
		Ultra	ProGuard\ Guardian	LTV\ Max Control	Protector de Strut\ Bases de Strut	HiJacker\ Soporte\ Hidráulico	Ultra	ProGuard\ Guardian	LTV\ Max Control	Protector de Strut\ Bases de Strut	HiJacker\ Soporte\ Hidráulico

DODGE

DODGE

A100 TRUCK ESTABILIZADORES DE DIRECCIÓN

		Delantero	Trasero
70	Estabilizador de Dirección Sistema Dual c/ Eje de Viga en I	6802SE ⁸⁴
	Estabilizador de Dirección Sistema Sencillo c/ Eje de Viga en I	6803SE ⁸⁴
64-69	Sistema Dual	6802SE ⁸⁴

ADVENTURER PROSPECTOR

72-93	susp. Del c/resorte 2da. Serie 72	70166	70167
-------	-----------------------------------	------	------	------	------	-------	------	------	------	------	-------

ARIES

86-89	Todos	G55526	142567 142568 ⁵⁴ 142880 ⁵⁴ 142933 ⁵⁶ 142940 ⁵⁶	69632	81459	49369 ⁷
84-85	Todos	G55511	69632	81459	49369 ⁷
81-83	Todos	G55507	69632	81459	49369 ⁷

ASPEN

76-80	Todos	69704	81406	69703	81338	43138 ⁸ 49346 ⁷
-------	-------	-------	-------	------	------	------	-------	-------	------	------	--

ATOS

00-12	Todos	56980	42954
-------	-------	------	------	------	------	-------	------	------	------	------	-------

ATTITUDE

12-14	Izquierdo	G52353	70095
	Derecho	G52354	70095
09-11	Izquierdo	G52154	70036
	Derecho	G52155	70036
06-08	Izquierdo	G52154	143352	70036
	Derecho	G52155	143352	70036
05-08	Todos	143352

AVENGER

08-14	Izquierdo	G52117	143336 ⁵³	G51863	143337 ⁵³
	Derecho	G52118	143336 ⁵³	G51863	143337 ⁵³
95-00	Todos	G55820	142419 ⁵³	G51254	142419 ⁵³

CALIBER

12	Izquierdo	G52081	G51842	143337 ⁵³
	Derecho	G52082	G51842	143337 ⁵³

7 Paquetes en pares; kit de mangueras de aire incluido

53 Montaje de Strut. Es probable reutilizar algunas partes del E.O.

56 El Kit de Montaje incluye: Montaje, Parachoques y Retenedores. Es probable reutilizar algunas partes del E.O.

66 Asiento de Resorte Superior con Espaciador. Es probable reutilizar algunas partes del E.O.

8 Paquetes en pares

54 Kit con Montaje y Rodamiento. Es probable que reutilizar algunas partes del E.O.

64 El Kit de Montaje incluye: Aislador de Goma del Asiento de Resorte. Es probable reutilizar algunas partes del E.O.

84 Amortiguador de repuesto para los vehículos con el kit de montaje aftermarket GRC

AMORTIGUADORES Y STRUTS

Año	Notas de Aplicación	From					Rear				
		Ultra	ProGuard\ Guardian	LTV\ Max Control	Protector de Strut\ Bases de Strut	HiJacker\ Soporte\ Hidráulico	Ultra	ProGuard\ Guardian	LTV\ Max Control	Protector de Strut\ Bases de Strut	HiJacker\ Soporte\ Hidráulico

DODGE

DODGE

CALIBER (cont)

07-11	Izquierdo	G52081	143495 ⁵⁴	G51842	143337 ⁵³
	Derecho	G52082	143495 ⁵⁴	G51842	143337 ⁵³

CALIBER READYMOUNTS

		Delantero	Trasero
07-12	SXT, Izquierdo	G57176 ⁴⁰	G57178 ⁴⁰
	SXT, Derecho	G57177 ⁴⁰	G57178 ⁴⁰

CARAVAN / GRAND CARAVAN

13-16	Exc. Suspensión Autonivelable	143463 ⁵³	G64042
	Exc. Modelo R/T	G52131	143463 ⁵³
08-16	Todos	143463 ⁵³
08-12	Exc. Suspensión Autonivelable	G52131	143463 ⁵³	G64042
06-07	Todos	G56620	142931 ⁵⁴	43186
01-07	Exc. Sistema de Autonivelación NIVOMAT	G63690 ¹⁰	61605 ³⁴ 81878	49236 ⁷ 43186
95-07	Todos	43186
05	Todos	G56620	142931 ⁵⁴	G63690 ¹⁰	43186
01-04	Todos	G56620	142931 ⁵⁴	43186
96-00	Todos	142753 ⁶	43186
	Exc. Sistema de Autonivelación NIVOMAT	142753 ⁶ 142841 ⁵⁴	G63690 ¹⁰	61605 ³⁴ 81878	49236 ⁷ 43186
	Exc. Sistema de Autonivelación NIVOMAT	G55697	43186
95	Todos	G55525	142567 142568 ⁶⁴ 142880 ⁵⁴ 142933 ⁵⁶ 142940 ⁶⁶	G63426	61538 81529	43186
	Fab. desde 1/86	142568 ⁶⁴	43186
89-94	Fab. desde 1/86	G55525	142568 ⁶⁴ 142567 142880 ⁵⁴ 142933 ⁵⁶ 142940 ⁶⁶	G63426	61538 81529
87-94	Todos	G55525	142567 142568 ⁶⁴ 142880 ⁵⁴ 142933 ⁵⁶ 142940 ⁶⁶	G63426	61538 81529
90	Fab. desde 02/Enero/86	G55525	142940 ⁶⁶ 142567 142568 ⁶⁴ 142880 ⁵⁴ 142933 ⁵⁶	G63426	61538 81529

6 Se recomienda que cuando se reemplacen amortiguadores "quad", los 4 sean de la misma serie.

10 Los amortiguadores NIVOMAT son para aplicación trasera únicamente. Si los resortes tocan los amortiguadores, gírelos 180°.

40 Strut ReadyMount. Ensamble Completo

54 Kit con Montaje y Rodamiento. Es probable que reutilizar algunas partes del E.O.

64 El Kit de Montaje incluye: Aislador de Goma del Asiento de Resorte. Es probable reutilizar algunas partes del E.O.

7 Paquetes en pares; kit de mangueras de aire incluido

34 Si el resorte toca el amortiguador, gire el resorte 180°.



53 Montaje de Strut. Es probable reutilizar algunas partes del E.O.

56 El Kit de Montaje incluye: Montaje, Parachoques y Retenedores. Es probable reutilizar algunas partes del E.O.

66 Asiento de Resorte Superior con Espaciador. Es probable reutilizar algunas partes del E.O.

Texto en Negritas - Número de Parte Nuevo / Futuro









AMORTIGUADORES Y STRUTS

Año	Notas de Aplicación	Front					Rear				
			Ultra	ProGuard\ Guardian	LTV\ Max Control	Protector de Strut\ Bases de Strut	HiJacker\ Soporte\ Hidráulico		Ultra	ProGuard\ Guardian	LTV\ Max Control

DODGE

DODGE



CARAVAN / GRAND CARAVAN (cont)

86	Todos		142567 142568 ⁵⁴ 142880 ⁵⁴ 142933 ⁵⁶ 142940 ⁵⁶		G63426	61538 81529
	Fab. desde 1/86		G55525	142567 142568 ⁵⁴ 142880 ⁵⁴ 142933 ⁵⁶ 142940 ⁵⁶		G63426	61538 81529
	Fab. hasta 2/86		G55509	142567 142568 ⁵⁴ 142880 ⁵⁴ 142933 ⁵⁶ 142940 ⁵⁶		G63426	61538 81529
84-85	Todos		G55509		G63426	61538 81529



CARAVAN / GRAND CARAVAN READYMOUNTS

		Delantero		Trasero	
08-10	Todos	G57206 ⁴⁰		
01-07	Izquierdo	G56956 ⁴⁰		
	Derecho	G56957 ⁴⁰		
96-00	Exc. Sistema de Autonivelación NIVOMAT	G56910 ⁴⁰		
00	Todos	G56910 ⁴⁰		
87-95	Todos	G56907 ⁴⁰		
86	Fabricado desde Ene/86	G56907 ⁴⁰		





CARVAN

95-07	Todos			43186
-------	-------	---	------	------	------	------	---	------	------	------	------	------	-------

















CB-300

70-80	Todos		70176	
-------	-------	---	------	------	------	-------	---	------	------	------	------	------	------

CHALLENGER

08-10	Todos		143369 ⁵³		143335 ⁵³
70-74	Todos		82090		82131	43096 49106 ⁷

CHARGER

11-16	RWD, Izquierdo Includes Police		G511031	
	RWD, Derecho Includes Police		G511032	
11-13	AWD		143468 ⁵³	
07-10	AWD		G51970		143335 ⁵³
06-10	Todos			143335 ⁵³
	RWD		143369 ⁵³		143335 ⁵³
	RWD, Izquierdo		G51761		143335 ⁵³
	RWD, Izquierdo Modelo Policía		G51947		143335 ⁵³

7 Paquetes en pares; kit de mangueras de aire incluido

53 Montaje de Strut. Es probable reutilizar algunas partes del E.O.

56 El Kit de Montaje incluye: Montaje, Parachoques y Retenedores. Es probable reutilizar algunas partes del E.O.

64 El Kit de Montaje incluye: Aislador de Goma del Asiento de Resorte. Es probable reutilizar algunas partes del E.O.

40 Strut ReadyMount. Ensamble Completo

54 Kit con Montaje y Rodamiento. Es probable que reutilizar algunas partes del E.O.

63 El Kit de Montaje incluye: Aislador Parachoques. Es probable reutilizar algunas partes del E.O.

66 Asiento de Resorte Superior con Espaciador. Es probable reutilizar algunas partes del E.O.

Texto en Negritas - Número de Parte Nuevo / Futuro

AMORTIGUADORES Y STRUTS

Año	Notas de Aplicación	From					Rear				
		Ultra	ProGuard\ Guardian	LTV\ Max Control	Protector de Strut\ Bases de Strut	HiJacker\ Soporte\ Hidráulico	Ultra	ProGuard\ Guardian	LTV\ Max Control	Protector de Strut\ Bases de Strut	HiJacker\ Soporte\ Hidráulico

DODGE

DODGE

CHARGER (cont)

06-10	RWD, Derecho	↓	G51760	143335 ⁶³
	RWD, Derecho Modelo Policía	↓	G51948	143335 ⁶³
06-09	Exc. Paquete Policía w/Suspensión Nivomat	↓	G51721	143335 ⁶³
83-87	Todos	↓	G55507	G51047	142173 ⁶³
77-78	Todos	↓	81153	69703	81338	43138 ⁸
73-76	Todos	↓	81153	82131	43096 ⁸ 49106 ⁷
66-72	Todos	↓	82090	82131	43096 ⁸ 49106 ⁷

CHARGER READYMOUNTS

		Delantero	Trasero
06-10	RWD, Izquierdo	G57071 ⁴⁰
	RWD, Derecho	G57072 ⁴⁰

COLT

93-95	Todos	↓	G55911	142329 ⁶³	G51063	142419 ⁶³
92	Todos	↓	142419 ⁶³
	Hatchback	↓	G55592	G51249	142419 ⁶³
89-91	Hatchback	↓	G55592	G51249	142419 ⁶³
86-91	Vista, 4WD	↓	81739
84-91	Vista, FWD, Wagon	↓	69689	81464
87-88	Hatchback	↓	G55561
	Sedan	↓	G55561
79-83	Hatchback	↓	69689	81464
75-80	Wagon	↓	82156	43048 ⁸ 49151 ⁷
77-79	Exc. Wagon y Hatchback	↓	81676
71-74	Todos	↓	82156	43048 ⁸ 49151 ⁷

CORONET

73-76	Todos	↓	81153	82131	43096 ⁸ 49106 ⁷
65-72	Todos	↓	82090	82131	43096 ⁸ 49106 ⁷
57-59	Todos	↓	82072	81469	49110 ⁷
51-56	Todos	↓	81469	49110 ⁷

CUSTOM

57-61	Todos	↓	82072	81469	49110 ⁷
54-56	Todos	↓	81469	49110 ⁷

7 Paquetes en pares; kit de mangueras de aire incluido

40 Strut ReadyMount. Ensemble Completo



63 El Kit de Montaje incluye: Aislador Parachoques. Es probable reutilizar algunas partes del E.O.

Texto en Negritas - Número de Parte Nuevo / Futuro

8 Paquetes en pares

53 Montaje de Strut. Es probable reutilizar algunas partes del E.O.





AMORTIGUADORES Y STRUTS

Año	Notas de Aplicación	Front					Rear				
			Ultra	ProGuard\ Guardian	LTV\ Max Control	Protector de Strut\ Bases de Strut	HiJacker\ Soporte\ Hidráulico		Ultra	ProGuard\ Guardian	LTV\ Max Control

DODGE

DODGE



D50

79-82	RWD		G63950	61556 81714		G63907	61500 81147	77907	43048 ⁸ 49310 ⁷ 70163
82	4WD		G63418	61529	77418		G63419	61532 81538



D50 ESTABILIZADORES DE DIRECCIÓN

		Delantero	Trasero
79-82	RWD, Estabilizador de Dirección Sistema Sencillo	6802SE ⁸⁴





D200 HEAVY DUTY

72-80	Susp. Del. con resortes		70176	
-------	-------------------------	---	------	------	------	------	-------	---	------	------	------	------	------





















D250 HEAVY DUTY

72-93	Susp. Del. con resortes		70176	
-------	-------------------------	---	------	------	------	------	-------	---	------	------	------	------	------

D350 MINIBUS

81-93	Todos			70167
	susp. Del. C/resortes		70166		70167















DAKOTA

10	4WD			G63891
	RWD			G63890
05-09	Todos		G51815	143385⁵³	
	4WD		G51815	143385⁵³		G63891
	RWD		G51815	143385⁵³		G63890
97-04	Todos			G63403	61658 81923	58403 77403
	4WD		G63905	61601 81836	77905		G63403	61658 81923	58403 77403
	RWD		G63915	61512 81559	77915		G63403	61658 81923	58403 77403
87-96	4WD		G63881	61679 81902	77958		G63499	61584 81837
	RWD		G63915	61512 81559	77915		G63460	61511 81560

DAKOTA ESTABILIZADORES DE DIRECCIÓN

		Delantero	Trasero
87-94	4WD, Estabilizador de Dirección Sistema Sencillo	6804SE ⁸⁰

DART

13-16	Izquierdo Touring Suspensión		G52502	
	Derecho Touring Suspensión		G52503	
81-82	5.9L 8Cyl (360) Turbocharged; DOHC		69704	81406		81338
77-82	3.7L 6Cyl (225) RWD; 4BBL		69704	81406		81338
80	5.9L 8Cyl (360) Turbocharged; DIESEL		69704	81406		81338
77-78	5.9L 8Cyl (360) Turbocharged; DIESEL		69704	81406		81338
63-76	Todos		82090		81469	49110 ⁷

7 Paquetes en pares; kit de mangueras de aire incluido

53 Montaje de Strut. Es probable reutilizar algunas partes del E.O.

84 Amortiguador de repuesto para los vehículos con el kit de montaje aftermarket GRC

Texto en Negritas - Número de Parte Nuevo / Futuro

8 Paquetes en pares

80 No requiere soportes para el montaje, instalar sobre montajes de EO Veá Ref. C para Botas.

AMORTIGUADORES Y STRUTS

Año	Notas de Aplicación	Front					Rear				
		Ultra	ProGuard\ Guardian	LTV\ Max Control	Protector de Strut\ Bases de Strut	HiJacker\ Soporte\ Hidráulico	Ultra	ProGuard\ Guardian	LTV\ Max Control	Protector de Strut\ Bases de Strut	HiJacker\ Soporte\ Hidráulico

DODGE

DODGE

DART (cont)

62	Todos	82090	82131	49106 ⁷
60-61	Todos	82072	81469	49110 ⁷

DART K

86-89	2.2L 4Cyl (135) 2BBL	G55526	55526	69632	81459	42459
84-85	Todos	G55511
	2.2L 4Cyl (135) 2BBL	G55511	69632	81459	42459
82-83	2.2L 4Cyl (135) 2BBL	G55507	69632	81459	42459

DAYTONA

89-93	Todos	142567 ⁶ 142568 ⁶⁴ 142880 ⁵⁴ 142933 ⁵⁶
	Exc. Modelos Shelby Base	142567 ⁶ 142568 ⁶⁴ 142880 ⁵⁴ 142933 ⁵⁶	69632	81459	49369 ⁷
	Exc. Modelos Shelby y Base	G55526	142567 ⁶ 142568 ⁶⁴ 142880 ⁵⁴ 142933 ⁵⁶
	Exc. Modelos Shelby y Base	142940 ⁶⁶ 142567 ⁶ 142568 ⁶⁴ 142880 ⁵⁴ 142933 ⁵⁶
87-88	Todos	142567 ⁶
	Exc. Modelos Shelby Base	142567 ⁶	69632	81459	49369 ⁷
	Exc. Modelos Shelby y Base	G55526	142567 ⁶
	Exc. Modelos Shelby y Base	142940 ⁶⁶ 142567 ⁶
	Pacifica	142568 ⁶⁴ 142880 ⁵⁴ 142933 ⁵⁶ 142567 ⁶
86	Todos	G55526	142567 ⁶ 142568 ⁶⁴ 142880 ⁵⁴ 142933 ⁵⁶ 142940 ⁶⁶
	Exc. Modelos Shelby Base	G55526	142567 ⁶ 142568 ⁶⁴ 142880 ⁵⁴ 142933 ⁵⁶ 142940 ⁶⁶	69632	81459	49369 ⁷
84-85	Todos	G55511
	Exc. Modelos Shelby Base	G55511	69632	81459	49369 ⁷

DIPLOMAT

77-89	Todos	69704	81406	69703	81338	43138 ⁸ 49346 ⁷
-------	-------	-------	-------	-------	-------	-------	-------	-------	-------	-------	-------	--

6 Se recomienda que cuando se reemplacen amortiguadores "quad", los 4 sean de la misma serie.

8 Paquetes en pares

56 El Kit de Montaje incluye: Montaje, Parachoques y Retenedores. Es probable reutilizar algunas partes del E.O.



66 Asiento de Resorte Superior con Espaciador. Es probable reutilizar algunas partes del E.O.

7 Paquetes en pares; kit de mangueras de aire incluido

54 Kit con Montaje y Rodamiento. Es probable que reutilizar algunas partes del E.O.

64 El Kit de Montaje incluye: Aislador de Goma del Asiento de Resorte. Es probable reutilizar algunas partes del E.O.



















AMORTIGUADORES Y STRUTS

Año	Notas de Aplicación	Front					Rear				
			Ultra	ProGuard\ Guardian	LTV\ Max Control	Protector de Strut\ Bases de Strut	HiJacker\ Soporte\ Hidráulico		Ultra	ProGuard\ Guardian	LTV\ Max Control









DODGE

DODGE

DURANGO

04-09	Todos		G64016	61720		G63892	61734
01-03	Todos			G63403	77403
	4WD		G63905	61601 81836	77905		G63403	77403
	4WD, RWD			G63403	61658 81923	58403 77403
	RWD		G63915	61512 81559	77915		G63403	77403
99-00	Todos			G63403	61658 81923	58403 77403
	RWD		G63915	61512 81559	77915		G63403	61658 81923	58403 77403
98-00	4WD		G63905	61601 81836	77905		G63403	61658 81923	58403 77403
98	Todos			G63403	58403 77403



DYNASTY

88-93	Todos		142880 ⁵⁴ 142933 ⁵⁶	
	Exc. Sistema de Autonivelación NIVOMAT		142567 142568 ⁵⁴ 142940 ⁵⁶ 142880 ⁵⁴ 142933 ⁵⁶	
	Sistema Hidráulico de Autonivelación		142880 ⁵⁴ 142933 ⁵⁶		81793
	Exc. Sistema de Autonivelación NIVOMAT		G55526	142880 ⁵⁴ 142933 ⁵⁶	















DYNASTY READYMOUNTS

		Delantero		Trasero	
88-93	Exc. Sistema de Autonivelación NIVOMAT	G56985 ⁴⁰		







H-100 DIESEL

02-07	Todos		G64001		G63965
-------	-------	---	--------	------	------	------	------	---	--------	------	------	------	------

H100

11-13	Diesel		G64129		G64128
	Gas Izquierdo		G52459		G64130
	Gas Derecho		G52460		G64130
08-09	Diesel		G64129		G64128
	Gas Izquierdo		G52459		G64130
	Gas Derecho		G52460		G64130
02-07	2.5L 94 HP		G63909		G63949

H100 TRUCK

10	Diesel		G64129		G64128
	Gas Izquierdo		G52459		G64130
	Gas Derecho		G52460		G64130

40 Strut ReadyMount. Ensemble Completo

56 El Kit de Montaje incluye: Montaje, Parachoques y Retenedores. Es probable reutilizar algunas partes del E.O.



66 Asiento de Resorte Superior con Espaciador. Es probable reutilizar algunas partes del E.O.

Texto en Negritas - Número de Parte Nuevo / Futuro

54 Kit con Montaje y Rodamiento. Es probable que reutilizar algunas partes del E.O.

64 El Kit de Montaje incluye: Aislador de Goma del Asiento de Resorte. Es probable reutilizar algunas partes del E.O.



AMORTIGUADORES Y STRUTS

Año	Notas de Aplicación	From 					Rear 				
		Ultra	ProGuard\ Guardian	LTV\ Max Control	Protector de Strut\ Bases de Strut	HiJacker\ Soporte\ Hidráulico	Ultra	ProGuard\ Guardian	LTV\ Max Control	Protector de Strut\ Bases de Strut	HiJacker\ Soporte\ Hidráulico









DODGE

DODGE

H100 VAN

10	Gas Izquierdo		G52459
	Gas Derecho		G52460





INTREPID

98-04	Izquierdo		G55663	142827 ⁵⁵		G55856	142828 ⁵³
	Derecho		G55664	142827 ⁵⁵		G55856	142828 ⁵³
93-97	Izquierdo		G55663	142755 ⁶ 142842 ⁵⁴		G55665
	Derecho		G55664	142755 ⁶ 142842 ⁵⁴		G55665











INTREPID READYMOUNTS

				Delantero	Trasero
98-04	Izquierdo			G56962 ⁴⁰	G56964 ⁴⁰
	Derecho			G56963 ⁴⁰	G56964 ⁴⁰
93-97	Izquierdo			G56958 ⁴⁰	G56960 ⁴⁰
	Derecho			G56959 ⁴⁰	G56960 ⁴⁰





JOURNEY

09-15	Izquierdo		G52148		
	Derecho		G52149		
09-10	FWD			G51848





LANCER

87-89	Todos		G55526	142567 142568 ⁶⁴ 142880 ⁵⁴ 142933 ⁵⁶ 142940 ⁶⁶		69632	81459	49369 ⁷
86	Todos		G55526	142567 142568 ⁶⁴ 142880 ⁵⁴ 142933 ⁵⁶		69632	81459	49369 ⁷
	Fab. desde 02/Enero/86		G55526	142940 ⁶⁶ 142567 142568 ⁶⁴ 142880 ⁵⁴ 142933 ⁵⁶		69632	81459	49369 ⁷
85	Todos		G55511		69632	81459	49369 ⁷
61-62	Todos		82090		81469	49110 ⁷

M300

74	Todos		G63605		G63183	70175
	H3, M3, M-375 H4, M4		G63605		G63183	82065	70175

M350

74	Todos		G63605	
	H3, M3, M-375 H4, M4		G63605		82065

6 Se recomienda que cuando se reemplacen amortiguadores "quad", los 4 sean de la misma serie.

40 Strut ReadyMount. Ensemble Completo

54 Kit con Montaje y Rodamiento. Es probable que reutilizar algunas partes del E.O.

56 El Kit de Montaje incluye: Montaje, Parachoques y Retenedores. Es probable reutilizar algunas partes del E.O.

66 Asiento de Resorte Superior con Espaciador. Es probable reutilizar algunas partes del E.O.

Texto en Negritas - Número de Parte Nuevo / Futuro



7 Paquetes en pares; kit de mangueras de aire incluido

53 Montaje de Strut. Es probable reutilizar algunas partes del E.O.

55 El Kit de Montaje incluye: Montaje, Asiento de Resorte, Rodamiento y Aislador. Es probable reutilizar algunas partes del E.O.

64 El Kit de Montaje incluye: Aislador de Goma del Asiento de Resorte. Es probable reutilizar algunas partes del E.O.























AMORTIGUADORES Y STRUTS

Año	Notas de Aplicación	Front					Rear				
			Ultra	ProGuard\ Guardian	LTV\ Max Control	Protector de Strut\ Bases de Strut	HiJacker\ Soporte\ Hidráulico		Ultra	ProGuard\ Guardian	LTV\ Max Control













DODGE

DODGE

MAGNUM

05-08	Todos		143335 ⁵³	
	Exc. Suspensión Nivomat		G51721	143335 ⁵³	
	AWD		G51970		143335 ⁵³
	RWD		143369 ⁵³		143335 ⁵³
	RWD, Izquierdo		G51761		143335 ⁵³
	RWD, Izquierdo Performance Suspensión		G51947		143335 ⁵³
	RWD, Derecho		G51760		143335 ⁵³
	RWD, Derecho Performance Suspensión		G51948		143335 ⁵³
80-82	Todos		69704		
	5.9L 8Cyl (360) Turbocharged; DOHC		69704	81406		81338	
78-79	Todos		69704	81153		69703	81338	43138 ⁵
77	Todos		69704		



MAGNUM K

89	2.2L 4Cyl (135) 2BBL			69632
86-88	2.2L 4Cyl (135) 2BBL		55526		69632	81459	42459
84-85	Todos		G55511	
	2.2L 4Cyl (135) 2BBL		G55511		81459	42459
83	2.2L 4Cyl (135) 2BBL			69632	81459	42459
82	2.2L 4Cyl (135) 2BBL			69632



MAGNUM READYMOUNTS

		Delantero		Trasero	
05-08	RWD, Izquierdo	G57071 ⁴⁰		
	RWD, Derecho	G57072 ⁴⁰		



MB-300

81-93	Susp. Del. con resortes		70176	
-------	-------------------------	---	-------	-------	-------	-------	---	-------	-------	-------	-------



MB-350

81-93	Susp. Del. con resortes		70176	
-------	-------------------------	---	-------	-------	-------	-------	---	-------	-------	-------	-------



MB-400

70-80	Todos		70176	
-------	-------	---	-------	-------	-------	-------	---	-------	-------	-------	-------

MEADOWBROOK

51-54	Todos			81469	49110 ⁷
-------	-------	---	-------	-------	-------	-------	---	-------	-------	-------	-------	--------------------

MICROBUS

94-97	5.9L 8Cyl (360) Turbocharged; DOHC		G63661	61599		61600
-------	------------------------------------	---	--------	-------	-------	-------	---	-------	-------	-------	-------	-------

7 Paquetes en pares; kit de mangueras de aire incluido

40 Strut ReadyMount. Ensemble Completo

63 El Kit de Montaje incluye: Aislador Parachoques. Es probable reutilizar algunas partes del E.O.

8 Paquetes en pares

53 Montaje de Strut. Es probable reutilizar algunas partes del E.O.

Texto en Negritas - Número de Parte Nuevo / Futuro

AMORTIGUADORES Y STRUTS

Año	Notas de Aplicación	From					Rear				
		Ultra	ProGuard\ Guardian	LTV\ Max Control	Protector de Strut\ Bases de Strut	HiJacker\ Soporte\ Hidráulico	Ultra	ProGuard\ Guardian	LTV\ Max Control	Protector de Strut\ Bases de Strut	HiJacker\ Soporte\ Hidráulico

DODGE

DODGE

MICROBUS (cont)

88-93	5.9L 8Cyl (360) Turbocharged; DOHC	⊥	G63360	61650 81834	42963	⊕	61526 81091
-------	------------------------------------	---	--------	----------------	------	------	-------	---	------	----------------	------	------	------

MINI RAM

87-88	Todos	⊥	G55525	⊕	G63426	61538 81529
84-86	Todos	⊥	G63359 ³⁵	61523 ³⁵ 81096 ³⁵	58359 ³⁵ 77359 ³⁵	34052 ²	⊕	G63413 ³⁵	61522 ⁵ 81496	58413 77413	43085 ⁵ 49212 ⁷

MINI RAM READYMOUNTS

											Delantero	Trasero
87-88	Todos										G56907 ⁴⁰

MIRADA

80-83	Todos	⊥	69704	81406	⊕	69703	81338	43138 ⁶ 49346 ⁷
-------	-------	---	-------	-------	------	------	------	---	-------	-------	------	------	--

MONACO

77-78	Todos	⊥	81153	⊕	69703	81338 82131	49106 ⁷
	Exc. Paquete Policía	⊥	81153	⊕	69703	81338 82131	43138 ⁶ 49106 ⁷
	Paquete Policía	⊥	81153	⊕	69703	81338 82131	43096 ⁶ 49106 ⁷
74-76	Todos	⊥	69704	81406	⊕	82131	43096 ⁶ 49106 ⁷
73	Todos	⊥	82011	⊕	81091 82131	43096 ⁶
	Exc. Wagon	⊥	82011	⊕	81091 82131	49106 ⁷ 43096 ⁶
	Wagon	⊥	82011	⊕	81091 82131	49149 ⁷ 43096 ⁶
72	Todos	⊥	82011	⊕	82131	43096 ⁶ 49106 ⁷
71	Todos	⊥	82011	⊕	81091	43067 ⁸
	Wagon	⊥	82011	⊕	81091	49149 ⁷ 43067 ⁸
65-70	Todos	⊥	82011	⊕	82131	43096 ⁶ 49106 ⁷

NEON

00-05	Todos	⊥	142932 ⁵⁵	⊥	143256 ⁵³
	Exc. Modelo SRT4 Izquierdo	⊥	G55892	142932 ⁵⁵	⊥	G55894	143256 ⁵³
	Exc. Modelo SRT4 Derecho	⊥	G55892	142932 ⁵⁵	⊥	G55893	143256 ⁵³
95-99	Todos	⊥	G55679	142840 ⁵⁴	⊥	G55680	142393 ⁵³

NEON READYMOUNTS

											Delantero	Trasero
00-05	Exc. Modelo SRT4 Izquierdo										G56975 ⁴	G56973 ⁴⁰
	Exc. Modelo SRT4 Derecho										G56975 ⁴	G56974 ⁴⁰
95-99	Todos										G56966 ⁴⁰	G56967 ⁴⁰

NITRO

07-11	Todos	⊥	G51728	⊕	G63844
-------	-------	---	--------	------	------	------	------	---	--------	------	------	------	------

4 Número de futuro, las cantidades disponibles Q4 2016.

7 Paquetes en pares; kit de mangueras de aire incluido

35 Es necesaria abertura en brazo de control para instalar el producto fabricado antes de agosto 1988.

53 Montaje de Strut. Es probable reutilizar algunas partes del E.O.

55 El Kit de Montaje incluye: Montaje, Asiento de Resorte, Rodamiento y Aislador. Es probable reutilizar algunas partes del E.O.

Texto en Negritas - Número de Parte Nuevo / Futuro

6 Se recomienda que cuando se reemplacen amortiguadores "quad", los 4 sean de la misma serie.

8 Paquetes en pares

40 Strut ReadyMount. Ensamble Completo

54 Kit con Montaje y Rodamiento. Es probable que reutilizar algunas partes del E.O.

AMORTIGUADORES Y STRUTS

Año	Notas de Aplicación	Front					Rear						
				Ultra	ProGuard\ Guardian	LTV\ Max Control	Protector de Strut\ Bases de Strut	HiJacker\ Soporte\ Hidráulico			Ultra	ProGuard\ Guardian	LTV\ Max Control

DODGE

DODGE

NITRO READYMOUNTS

		Delantero	Trasero
07-11	Izquierdo	G57007 ⁴⁰
	Derecho	G57008 ⁴⁰

OMNI

90	Todos		G55594		G51047	142173 ⁵³
81-89	Todos		G55507		G51047	142173 ⁵³
78-80	Todos		G55507	142173 ⁵³

PB300 VAN

74-80	Todos		70176	
-------	-------	--	------	------	------	------	-------	--	------	------	------	------	------

PB350 VAN

81-83	Todos		70176	
-------	-------	--	------	------	------	------	-------	--	------	------	------	------	------

PICKUP 1/2 TON, D100 SERIES

91-93	Todos		70166		70167
	Todos		G63359	61523 ³⁵ 81096 ³⁵	58359 ³⁵ 77359 ³⁵	34052 ⁸ 70166		G63353	61526 81091	58353	43067 ⁸ 49149 ⁷ 70167
89-90	Todos		42962 70166		70167
	Todos		G63359	61523 ³⁵ 81096 ³⁵	58359 ³⁵ 77359 ³⁵	34052 ⁸ 42962 70166		G63353	61526 81091	58353	43067 ⁸ 49149 ⁷ 70167
	5.9L Turbocharged		42962 70166		42960 70167
88-90	3.7L 4BBL		42962 70166		42960 70167
72-88	Todos		70166		70167
	Todos		G63359	61523 ³⁵ 81096 ³⁵	58359 ³⁵ 77359 ³⁵	34052 ⁸ 70166		G63353	61526 81091	58353	43067 ⁸ 49149 ⁷ 70167
83	5.9L Turbocharged		42962 70166		70167
82	5.9L TBI		42962 70166		42960 70167
80	3.7L 4BBL		42962 70166		42960 70167
	5.9L TBI		42962 70166		42960 70167
73-74	3.7L 4BBL		42962 70166		42960 70167
72	3.7L 4BBL		42957 70166		42957 70167
	Susp. Del. con muelles hasta 1a. Serie 72		70166		70175 70167
70-71	Todos		61523 82046	82054
	3.7L 4BBL		61523 82046	42957		82054	42957
	Susp. Del. con muelles hasta 1a. Serie 72		61523 82046	82054	70175

7 Paquetes en pares; kit de mangueras de aire incluido

35 Es necesaria abertura en brazo de control para instalar el producto fabricado antes de agosto 1988.

53 Montaje de Strut. Es probable reutilizar algunas partes del E.O.

Texto en Negritas - Número de Parte Nuevo / Futuro

8 Paquetes en pares

40 Strut ReadyMount. Ensamble Completo

AMORTIGUADORES Y STRUTS

Año	Notas de Aplicación	From					Rear				
		Ultra	ProGuard\ Guardian	LTV\ Max Control	Protector de Strut\ Bases de Strut	HiJacker\ Soporte\ Hidráulico	Ultra	ProGuard\ Guardian	LTV\ Max Control	Protector de Strut\ Bases de Strut	HiJacker\ Soporte\ Hidráulico

DODGE

DODGE

PICKUP 1/2 TON, D100 SERIES (cont)

61-69	Todos	○	82046	○	82054
	Susp. Del. con muelles hasta 1a. Serie 72	○	82046	○	82054	70175
60	Todos	○	○	82054

PICKUP 1/2 TON, D100 SERIES ESTABILIZADORES DE DIRECCIÓN

		Delantero	Trasero
86-89	Estabilizador de Dirección Sistema Sencillo	6802SE ⁸⁴
72-79	Estabilizador de Dirección Sistema Sencillo	6802SE ⁸⁴
60-71	Estabilizador de Dirección Sistema Sencillo c/ Eje de Viga en I	6802SE ⁸⁴

PICKUP 1/2 TON, RAM 1500

11-14	Todos	○	○	G64044
	4WD	○	G51856	○	G64044
	RWD	○	G64043	○	G64044
09-10	Todos	○	○	G64044
	4WD	○	G51856	143389 ⁸³	○	G64044
	RWD	○	G64043	○	G64044
06-08	4WD w/5.7L	○	77980	○
	4WD, Mega Cab	○	61712	○
	4WD; Exc. Mega Cab	○	G51758	143324 ⁸³	○	G63961	61691 81931
	RWD; Exc. Mega Cab	○	G63958	81933	77954	○	G63962	61692
06-07	Exc. Mega Cab	○	○	58412 77412
02-05	Todos	○	○	G63675	58412 77412
	4WD	○	G63848	81932	77947	○	G63675	61691 81931	58412 77412
	RWD	○	G63958	81933	77954	○	G63675	61692	58412 77412
94-01	Todos	○	○	G63662	61600 81873	58662 77662	43181 ⁸ 49235 ⁷
	4WD	○	G63673	61634 81919	58673 77673	○	G63662	61600 81873	58662 77662	43181 ⁸ 49235 ⁷
	RWD	○	G63661	61599 81928	58661 77661	○	G63662	61600 81873	58662 77662	43181 ⁸ 49235 ⁷

PICKUP 1/2 TON, RAM 1500 ESTABILIZADORES DE DIRECCIÓN

		Delantero	Trasero
00-07	4WD, Con Número de EO 52106909AB, AC, AD	6847SE ⁸²
94-01	RWD, GAS Estabilizador de Dirección para Suspensión con Resortes Helicoidales	6859SE ⁸²
97-99	4WD, Con Número de EO 52039280	6846SE ⁸²
94-97	4WD, Con Número de EO 52038276	6804SE ⁸⁰

PICKUP 1/2 TON, RAM 1500 READYMOUNTS

		Delantero	Trasero
09-10	4WD	G57147³
06-08	4WD; Exc. Mega Cab	G57053¹⁰

3 Número de parte futuro
 8 Paquetes en pares
 53 Montaje de Strut. Es probable reutilizar algunas partes del E.O.
 82 Use kit si está señalado. Vea Ref. C para Botas.

7 Paquetes en pares; kit de mangueras de aire incluido
 40 Strut ReadyMount. Ensamble Completo
 80 No requiere soportes para el montaje, instalar sobre montajes de EO Vea Ref. C para Botas.
 84 Amortiguador de repuesto para los vehículos con el kit de montaje aftermarket GRC

Texto en Negritas - Número de Parte Nuevo / Futuro

AMORTIGUADORES Y STRUTS

Año	Notas de Aplicación	Front					Rear				
		Ultra	ProGuard\ Guardian	LTV\ Max Control	Protector de Strut\ Bases de Strut	HiJacker\ Soporte\ Hidráulico	Ultra	ProGuard\ Guardian	LTV\ Max Control	Protector de Strut\ Bases de Strut	HiJacker\ Soporte\ Hidráulico

DODGE

DODGE

PICKUP 1/2 TON, W100 SERIES

90-93	Exc. Kit de Levantamiento	○	G63183	61632 81825	58183 77183	○	G63389	61633 81342	58389 77389
81-93	Exc. Kit de Levantamiento	↑	70175	↑
86-89	Exc. Kit de Levantamiento	○	G63183	61632 81825	58183 77183	70175	○	G63389	61633 81342	58389 77389
81-85	Exc. Kit de Levantamiento	○	G63183	61632 81825	58183 77183	○	G63389	61633 81342	58389 77389
75-80	Todos	↑	70175	↑
72-80	Todos	○	G63183	61632 81825	58183 77183	70175	○	G63389	61633 81342	58389 77389
61-71	Todos	○	G63183	61632 81825	58183 77183	70175	○	82054
60	Todos	○	82065	○	82054

PICKUP 1/2 TON, W100 SERIES ESTABILIZADORES DE DIRECCIÓN

		Delantero	Trasero
90-93	Estabilizador de Dirección Sistema Sencillo	6802SE ⁸⁴
60-89	Estabilizador de Dirección Sistema Sencillo	6803SE ⁸⁴
60-86	Estabilizador de Dirección Sistema Dual; Exc. Servofreno montado del lado del Eje del Conductor	6802SE ⁸⁴

PICKUP 3/4 TON, D200 SERIES

90-93	Todos	↑	70166	○	G63353	61526 81091	58353	43067 ⁸ 49149 ⁷ 70167
	Exc. Paquete HD	↑	G63359 ³⁵	61523 ³⁵ 81096 ³⁵	58359 ³⁵ 77359 ³⁵	34052 ⁸ 70166	↑	70167
82-93	Paquete HD	↑	G63360 ³⁵	61650 81834	58360	70166	↑	70167
72-93	Todos	↑	70166	↑	70167
90	5.9L Turbocharged, Diesel	↑	42962 70166	↑	42960 70167
82-89	Todos	↑	77359 ³⁵	70166	○	G63353	61526 81091	58353	43067 ⁸ 49149 ⁷ 70167
	Exc. Paquete HD	↑	G63359 ³⁵	61523 ³⁵ 81096 ³⁵	58359 ³⁵	34052 ⁸ 70166	↑	70167
89	5.9L Turbocharged	↑	42962 70166	↑	70167
	5.9L Turbocharged, Diesel	↑	70166	↑	42960 70167
81	Todos	↑	70166	○	G63353	61526 81091	58353	43067 ⁸ 70167
	Exc. Paquete HD	↑	G63359 ³⁵	61523 ³⁵ 81096 ³⁵	58359 ³⁵ 77359 ³⁵	34052 ⁸ 70166	↑	49149 ⁷ 70167
	Paquete HD	↑	G63360 ³⁵	70166	↑	70167
	165.0(WheelBase) Paquete HD	↑	61650 81834	58360	70166	↑	70167
77-80	Paquete HD	↑	G63360 ³⁵	61650	58360	70166	↑	70167
	165.0(WheelBase) Paquete HD	↑	81834	70166	↑	70167
72-80	Todos	↑	70166	○	G63353	61526 81091	58353	43067 ⁸ 49149 ⁷ 70167
	Exc. Paquete HD	↑	G63359 ³⁵	61523 ³⁵ 81096 ³⁵	58359 ³⁵ 77359 ³⁵	34052 ⁸ 70166	↑	70167



7 Paquetes en pares; kit de mangueras de aire incluido

35 Es necesaria abertura en brazo de control para instalar el producto fabricado antes de agosto 1988.

8 Paquetes en pares

84 Amortiguador de repuesto para los vehículos con el kit de montaje aftermarket
GRG













AMORTIGUADORES Y STRUTS

Año	Notas de Aplicación										
		Ultra	ProGuard\ Guardian	LTV\ Max Control	Protector de Strut\ Bases de Strut	HiJacker\ Soporte\ Hidráulico	Ultra	ProGuard\ Guardian	LTV\ Max Control	Protector de Strut\ Bases de Strut	HiJacker\ Soporte\ Hidráulico

DODGE

DODGE











































PICKUP 3/4 TON, D200 SERIES (cont)

75-76	Paquete HD		G63360 ³⁵	70166		70167
	165.0(WheelBase) Paquete HD		61650 81834	58360	70166		70167
72-74	Paquete HD		G63360 ³⁵	61650 81834	58360	70166		70167
61-71	Todos		82046		82054
	Susp. Del. con muelles hasta 1a. Serie 72		82046		82054	70175
60	Todos			82054

PICKUP 3/4 TON, D200 SERIES ESTABILIZADORES DE DIRECCIÓN

		Delantero	Trasero
73-93	Estabilizador de Dirección Sistema Sencillo	6802SE ⁸⁴
60-71	Estabilizador de Dirección Sistema Sencillo c/ Eje de Viga en I	6802SE ⁸⁴

PICKUP 3/4 TON, RAM 2500

11-12	Todos			77950
	4WD			G64013	61716	77950
	RWD		77949		77950
09-10	4WD		77948		61716	77950
07-10	RWD, Standard Cab Pickup			G63970	77950
03-10	Todos			77950
	4WD, PBV 8800			G64013	77950
	RWD		77949		77950
05-08	4WD		G64011	61714	77948		61716	77950
03-06	RWD, Crew Cab Pickup			G63971	61710	77950
	RWD, Standard Cab Pickup			G63970	61709	77950
06	4WD w/5.7L		77980		77950
03-04	4WD		77948		61716	77950
03	4WD, GAS Exc. PBV 8600 #			G63662	61600 81873	77950
	4WD, GAS Exc. PBV 8800#			61600	77950
99-02	4WD, Exc. PBV 8600 #		81919	
94-02	4WD, DIESEL PBV 8800		G63674	61635	58674 77674		G63675	61642 81921	58675 77675
	4WD, GAS Exc. PBV 8600 #		G63673	61634	58673 77673		G63662	61600 81873	58662 77662	49235 ⁷
	4WD, GAS Exc. PBV 8800#			61600
	RWD		G63661	61599 81928	58661 77661		G63662	61600 81873	58662 77662	43181 ⁸ 49235 ⁷
95-96	4WD, CNG Exc. PBV 8600 #		G63673	61634	58673		G63662	61600 81873	58662 77662	49235 ⁷
	4WD, CNG Exc. PBV 8800#			61600
94-95	4WD, Exc. PBV 8600 #		81919	





7 Paquetes en pares; kit de mangueras de aire incluido

35 Es necesaria abertura en brazo de control para instalar el producto fabricado antes de agosto 1988.

8 Paquetes en pares

84 Amortiguador de repuesto para los vehiculos con el kit de montaje aftermarket GRC

AMORTIGUADORES Y STRUTS

Año	Notas de Aplicación										
			Ultra	ProGuard/ Guardian	LTV/ Max Control	Protector de Strut/ Bases de Strut	HiJacker/ Soporte/ Hidráulico		Ultra	ProGuard/ Guardian	LTV/ Max Control



















DODGE

DODGE

PICKUP 3/4 TON, RAM 2500 ESTABILIZADORES DE DIRECCIÓN

		Delantero	Trasero
00-07	4WD, Con Número de EO 52106909AB, AC, AD	6847SE ⁸²
94-02	RWD, GAS Estabilizador de Dirección para Suspensión con Resortes Helicoidales	6859SE ⁸²
97-99	4WD, Con Número de EO 52039280	6846SE ⁸²
94-97	4WD, Con Número de EO 52038276	6804SE ⁸⁰





























PICKUP 3/4 TON, W200 SERIES

Año	Modelo	Icono	G63183	61632 81825	58183 77183	Icono	G63389	61633 81342	58389 77389
81-93	Exc. Crew Cab y Kit de Levantamiento		70175	
	Standard Cab Pickup Exc. Kit de Levantamiento		70175	
89-90	Van 5.9L 4BBL		42957	
85-87	3.7L 4BBL		42957	
75-80	Todos		70175	
72-80	Todos		G63183	61632 81825	58183 77183	70175		G63389	61633 81342	58389 77389
69-71	Todos		G63183	61632 81825	58183 77183	70175		82054
61-67	Todos		G63183	61632 81825	58183 77183	70175		82054
60	Todos		82065		82054

PICKUP 3/4 TON, W200 SERIES ESTABILIZADORES DE DIRECCIÓN

		Delantero	Trasero
90-93	Estabilizador de Dirección Sistema Sencillo	6802SE ⁸⁴
69-89	Estabilizador de Dirección Sistema Sencillo	6803SE ⁸⁴
60-86	Estabilizador de Dirección Sistema Dual; Exc. Servofreno montado del lado del Eje del Conductor	6802SE ⁸⁴
60-67	Estabilizador de Dirección Sistema Sencillo	6803SE ⁸⁴

PICKUP 1 TON, D300 SERIES

Año	Modelo	Icono	G63360	61650 81834	58360	70166	Icono	G63353	61526 81091	58353	43067 ⁸ 49149 ⁷
91-93	Todos		58360	70166		G63353	61526 81091	58353	43067 ⁸ 49149 ⁷
	Paquete HD		G63360	61650 81834	70166	
81-93	Todos		70166	
	Susp. Del. c/ Resortes		70176 70166	
	susp. Del. C/resortes		70166		70167
89-90	3.7L 4BBL		42963 70166		42960
90	Todos		G63360	58360	70166		G63353	61526 81091	58353	43067 ⁸ 49149 ⁷
	Paquete HD		61650 81834	70166	
81-89	Todos		58360	70166		G63353	61526 81091	58353	43067 ⁸ 49149 ⁷
	Paquete HD		G63360	61650 81834	70166	
88	3.7L 4BBL		42963 70166	
81-87	3.7L 4BBL		42963 70166		42960
81-83	5.9L Turbocharged, Diesel		42963 70166		42960
82	5.5L MFI		42963 70166	

7 Paquetes en pares; kit de mangueras de aire incluido

80 No requiere soportes para el montaje, instalar sobre montajes de EO Vea Ref. C para Botas.

84 Amortiguador de repuesto para los vehículos con el kit de montaje aftermarket GRC

8 Paquetes en pares

82 Use kit si está señalado. Vea Ref. C para Botas.

AMORTIGUADORES Y STRUTS

Año	Notas de Aplicación	Front					Rear				
		Ultra	ProGuard\ Guardian	LTV\ Max Control	Protector de Strut\ Bases de Strut	HiJacker\ Soporte\ Hidráulico	Ultra	ProGuard\ Guardian	LTV\ Max Control	Protector de Strut\ Bases de Strut	HiJacker\ Soporte\ Hidráulico

DODGE

DODGE

PICKUP 1 TON, D300 SERIES (cont)

78-80	3.7L 4BBL	⊕	42963 70176	⊕	42960
80	Todos	⊕	70176	⊕	42960
	Todos	⊕	58360	70176	⊕	G63353	61526 81091	58353	43067 ⁸ 49149 ⁷ 42960
	Paquete HD	⊕	G63360	61650 81834	70176	⊕	42960
	5.2L MFI	⊕	42963 70176	⊕	42960
	5.9L Turbocharged, Diesel	⊕	42963 70176	⊕	42960
	susp. Del. C/resortes	⊕	70176	⊕	70167 42960
72-79	Todos	⊕	70176	⊕
	Todos	⊕	58360	70176	⊕	G63353	61526 81091	58353	43067 ⁸ 49149 ⁷
	Paquete HD	⊕	G63360	61650 81834	70176	⊕
	susp. Del. C/resortes	⊕	70176	⊕	70167
72	Susp. Del. con muelles hasta 1a. Serie 72	⊕	70176	⊕	70175
61-71	Todos	⊕	82046	⊕	82065
	Susp. Del. con muelles hasta 1a. Serie 72	⊕	82046	⊕	82065	70175
67-68	3.7L 4BBL	⊕	82046	42957	⊕	82065	42957

PICKUP 1 TON, D300 SERIES ESTABILIZADORES DE DIRECCIÓN

		Delantero	Trasero
75-93	Estabilizador de Dirección Sistema Sencillo	6802SE ⁸⁴
72-74	Estabilizador de Dirección Sistema Sencillo c/ Suspensión Delantera de Resorte Helicoidal	6802SE ⁸⁴
60-71	Estabilizador de Dirección Sistema Sencillo c/ Eje de Viga en I	6802SE ⁸⁴

PICKUP 1 TON, RAM 3500





11-12	Todos	⊕	⊕	77950
03-12	RWD	⊕	77949	⊕	77950
07-10	RWD, Standard Cab Pickup	⊕	⊕	G63970	77950
03-10	Todos	⊕	⊕	77950
	4WD	⊕	77948	⊕	77950
03-07	RWD, Crew Cab Pickup	⊕	⊕	G63971	61710	77950
03-06	RWD, Standard Cab Pickup	⊕	⊕	G63970	61709	77950
06	4WD w/5.7L	⊕	77980	⊕	77950
95-02	4WD	⊕	G63674	61635	58674 77674	⊕	G63675	61642 81921	58675 77675
	RWD, Eje Delantero Rígido	⊕	G63674	61635	58674 77674	⊕	G63675	61642 81921	58675 77675
	RWD, Exc. Eje Delantero Rígido	⊕	G63661	61599 81928	58661 77661	⊕	G63662	61600 81873	58662 77662	43181 ⁸ 49235 ⁷
94	Todos	⊕	81096	⊕
	4WD	⊕	G63674	61635 81096	58674 77674	⊕	G63675	61642 81921	58675 77675

7 Paquetes en pares; kit de mangueras de aire incluido

8 Paquetes en pares

84 Amortiguador de repuesto para los vehículos con el kit de montaje aftermarket
GRC





AMORTIGUADORES Y STRUTS

Año	Notas de Aplicación										
			Ultra	ProGuard\ Guardian	LTV\ Max Control	Protector de Strut\ Bases de Strut	HiJacker\ Soporte\ Hidráulico		Ultra	ProGuard\ Guardian	LTV\ Max Control

DODGE

DODGE













PICKUP 1 TON, RAM 3500 (cont)

94	RWD, Eje Delantero Rígido		G63674	61635 81096	58674 77674		G63675	61642 81921	58675 77675
	RWD, Exc. Eje Delantero Rígido		G63661	61599 81928 81096	58661 77661		G63662	61600 81873	58662 77662	43181 ⁸ 49235 ⁷

PICKUP 1 TON, RAM 3500 ESTABILIZADORES DE DIRECCIÓN

		Delantero	Trasero
00-07	4WD, Con Número de EO 52106909AB, AC, AD	6847SE ⁸²
	RWD, Con Número de EO 52106909AB, AC, AD w/Eje Delantero Rígido	6847SE ⁸²
94-02	RWD, GAS Estabilizador de Dirección para Suspensión con Resortes Helicoidales	6859SE ⁸²
97-99	4WD, Con Número de EO 52039280	6846SE ⁸²
94-97	4WD, Con Número de EO 52038276	6804SE ⁸⁰















PICKUP 1 TON, W300 SERIES

81-93	Exc. Suspensión Quad y Kit de Levantamiento		G63183	61632 81825	58183 77183		G63389	61633 81342	58389 77389
	Exc. Suspensión Quad y Kit de Levantamiento		70175	
72-80	Todos		G63183	61632 81825	58183 77183	70175		G63389	61633 81342	58389 77389
68-71	Todos		G63183	61632 81825	58183	70175		G63183	61632 81825	58183 77183	70175
64-67	Todos		G63183	61632 81825	58183 77183	70175		G63183	61632 81825	58183 77183	70175
61-63	Todos		G63183	61632 81825	58183 77183	70175		G63183	61632 81825	58183	70175

PICKUP 1 TON, W300 SERIES ESTABILIZADORES DE DIRECCIÓN

		Delantero	Trasero
90-93	Estabilizador de Dirección Sistema Sencillo	6802SE ⁸⁴
60-89	Estabilizador de Dirección Sistema Sencillo	6803SE ⁸⁴
60-86	Estabilizador de Dirección Sistema Dual; Exc. Servofreno montado del lado del Eje del Conductor	6802SE ⁸⁴









PICKUP, RAM 50

87-93	4WD		61529	77418		G63419	61532 81538
	RWD		G63950	61556 81714		G63907	61500 81147	77907	43048 ⁸ 49310 ⁷
	RWD			70163
83-86	Todos			70163
	Todos		61556 81714		G63907	61500	77907	43048 ⁸ 49310 ⁷ 70163
	4WD		G63418		70163
	RWD		G63950		81147	70163

PICKUP, RAM 50 ESTABILIZADORES DE DIRECCIÓN

		Delantero	Trasero
83-93	RWD, Estabilizador de Dirección Sistema Sencillo	6802SE ⁸⁴

POLARA

73	Todos		82011		81091
	Exc. Wagon		82011		82131 81091	43096 ⁸ 49106 ⁷
	Wagon		82011		81091	49149 ⁷ 43067 ⁸
72	Todos		82011		82131	43096 ⁸ 49106 ⁷

7 Paquetes en pares; kit de mangueras de aire incluido

80 No requiere soportes para el montaje, instalar sobre montajes de EO Vea Ref. C para Botas.

84 Amortiguador de repuesto para los vehículos con el kit de montaje aftermarket GRC

8 Paquetes en pares

82 Use kit si está señalado. Vea Ref. C para Botas.

AMORTIGUADORES Y STRUTS

Año	Notas de Aplicación	Front					Rear				
		Ultra	ProGuard\ Guardian	LTV\ Max Control	Protector de Strut\ Bases de Strut	HiJacker\ Soporte\ Hidráulico	Ultra	ProGuard\ Guardian	LTV\ Max Control	Protector de Strut\ Bases de Strut	HiJacker\ Soporte\ Hidráulico

DODGE

DODGE

POLARA (cont)

71	Todos	○	82011	○	81091	43067 ⁶
	Wagon	○	82011	○	81091	49149 ⁷ 43067 ⁸
65-70	Todos	○	82011	○	82131	43096 ⁶ 49106 ⁷
62-64	Todos	○	82090	○	82131	43096 ⁶ 49106 ⁷
60-61	Todos	○	82072	○	81469	49110 ⁷

RAIDER

87-89	Todos	○	G63418	61529	77418	○
	Exc. Sport Utility	○	G63418	61529	77418	○	G63492	81318	77492
	2.6L 4Cyl L	○	G63418	61529	77418	○	61506
89	3.0L 6 Cyl V	○	G63418	61529	77418	○	61568
	Sport Utility	○	G63418	61529	77418	○	G63604

RAIDER ESTABILIZADORES DE DIRECCIÓN

		Delantero		Trasero	
87-89	Estabilizador de Dirección Sistema Sencillo	6802SE ⁸⁴		

RAM 4000

04-08	Todos	○	G63674	○	G63675
-------	-------	---	--------	-------	-------	-------	-------	---	--------	-------	-------	-------	-------

RAM VAN

97-01	Todos	↓	70166	↓	70167
-------	-------	---	-------	-------	-------	-------	-------	---	-------	-------	-------	-------	-------

RAM VAN 1500, 2500 Y 3500

99-03	Todos	↓	70166	↓
-------	-------	---	-------	-------	-------	-------	-------	---	-------	-------	-------	-------	-------

RAM WAGON

94-98	Todos	↓	61668	↓
-------	-------	---	-------	-------	-------	-------	-------	---	-------	-------	-------	-------	-------

RAM WAGON Y VAN

97-01	Todos	↓	70166	↓	70167
-------	-------	---	-------	-------	-------	-------	-------	---	-------	-------	-------	-------	-------

RAMCHARGER

99-01	Todos	○	61599	○	G63662	61600
95-96	Todos	○	81096	○
	RWD	○	61523 81096	○	61526 81091
	RWD	○	81096	○	70167
84-94	5.9L Turbocharged, MFI	↓	↓	42960
94	5.9L 8Cyl (360) Turbocharged, DOHC	↓	42963	↓
	5.9L Turbocharged, FI	↓	42962	↓	42960
91-93	5.9L Turbocharged, FI	↓	↓	42960
89-93	RWD	○	G63359	61523 ³⁵ 81096 ³⁵	58359 ³⁵ 77359 ³⁵	34052 ⁸	○	G63353	61526 81091	58353	43067 ⁶ 49149 ⁷
84-93	5.9L 8Cyl V (360)	○	42963	○



7 Paquetes en pares; kit de mangueras de aire incluido

35 Es necesaria abertura en brazo de control para instalar el producto fabricado antes de agosto 1988.

8 Paquetes en pares

84 Amortiguador de repuesto para los vehículos con el kit de montaje aftermarket GRC

































AMORTIGUADORES Y STRUTS

Año	Notas de Aplicación	Front					Rear				
			Ultra	ProGuard\ Guardian	LTV\ Max Control	Protector de Strut\ Bases de Strut	HiJacker\ Soporte\ Hidráulico		Ultra	ProGuard\ Guardian	LTV\ Max Control

DODGE

DODGE



RAMCHARGER (cont)

76-93	4WD		G63183	61632 81825	58183	70175		G63389	61633 81342	58389
88-90	RWD			70167
84-90	5.9L Turbocharged, FI		42962		42960
76-88	RWD		G63359 ³⁵	61523 ³⁵ 81096 ³⁵	58359 ³⁵ 77359 ³⁵	34052 ⁸		G63353	61526 81091	58353	43067 ⁸ 49149 ⁷
82-83	5.9L Turbocharged, FI		42957 42962		42960
81	5.9L Turbocharged, DOHC		42962	
	5.9L Turbocharged, FI		42957		42960
80	5.9L Turbocharged, DOHC		42962		42960
	5.9L Turbocharged, FI		42957	
75	Todos			58353	43067 ⁸ 49149 ⁷
	4WD		G63183	61632 81825	58183	70175		58353	43067 ⁸ 49149 ⁷
	RWD		G63359 ³⁵	61523 ³⁵ 81096 ³⁵	58359 ³⁵ 77359 ³⁵	34052 ⁸		G63353	61526 81091	58353	43067 ⁸ 49149 ⁷
74	Todos		58183		58353	43067 ⁸ 49149 ⁷
	4WD		G63183	81825	58183		58353	43067 ⁸ 49149 ⁷
	4WD		61632	58183	70175		58353	43067 ⁸ 49149 ⁷
	RWD		58183		G63353	61526 81091	58353	43067 ⁸ 49149 ⁷





RAMCHARGER ESTABILIZADORES DE DIRECCIÓN

		Delantero	Trasero
87-93	RWD, Estabilizador de Dirección Sistema Sencillo	6802SE ⁸⁴
75-93	4WD, Estabilizador de Dirección Sistema Sencillo	6803SE ⁸⁴
74-86	Estabilizador de Dirección Sistema Dual; Exc. Servofreno montado del lado del Eje del Conductor	6802SE ⁸⁴
74	Estabilizador de Dirección Sistema Sencillo	6803SE ⁸⁴



RAMPAGE

82-84	Todos		G55507	
-------	-------	---	--------	------	------	------	------	---	------	------	------	------	------





RD200

78-80	Todos		70175	
	Todos		G63183	81825	70175		81342

ROYAL MONACO

75-77	Todos		69704	81406		82131	43096 ⁸ 49106 ⁷
-------	-------	---	-------	-------	------	------	------	---	------	-------	------	------	--

SHADOW

92-94	Todos		55526	
	Todos		G55526	142567 142568 ⁸⁴ 142880 ⁸⁴ 142933 ⁸⁶ 142940 ⁸⁶	55526		69632	81459	42459 49369 ⁷

7 Paquetes en pares; kit de mangueras de aire incluido

35 Es necesaria abertura en brazo de control para instalar el producto fabricado antes de agosto 1988.

56 El Kit de Montaje incluye: Montaje, Parachoques y Retenedores. Es probable reutilizar algunas partes del E.O.

66 Asiento de Resorte Superior con Espaciador. Es probable reutilizar algunas partes del E.O.

8 Paquetes en pares

54 Kit con Montaje y Rodamiento. Es probable que reutilizar algunas partes del E.O.

64 El Kit de Montaje incluye: Aislador de Goma del Asiento de Resorte. Es probable reutilizar algunas partes del E.O.

84 Amortiguador de repuesto para los vehiculos con el kit de montaje aftermarket GRC

AMORTIGUADORES Y STRUTS

Año	Notas de Aplicación	Front					Rear				
		Ultra	ProGuard\ Guardian	LTV\ Max Control	Protector de Strut\ Bases de Strut	HiJacker\ Soporte\ Hidráulico	Ultra	ProGuard\ Guardian	LTV\ Max Control	Protector de Strut\ Bases de Strut	HiJacker\ Soporte\ Hidráulico

DODGE

DODGE

SHADOW (cont)

91	Todos	G55526	142567 142568 ⁶⁴ 142880 ⁵⁴ 142933 ⁵⁶ 142940 ⁶⁶	69632	81459	42459 49369 ⁷
88-90	Todos	55526
	Todos	G55526	142567 142568 ⁶⁴ 142880 ⁵⁴ 142933 ⁵⁶ 142940 ⁶⁶	55526	69632	81459	42459 49369 ⁷
87	Todos	G55526	142567 142568 ⁶⁴ 142880 ⁵⁴ 142933 ⁵⁶ 142940 ⁶⁶	69632	81459	49369 ⁷

SHADOW READYMOUNTS

		Delantero	Trasero
89-94	Exc. Sistema de Autonivelación NIVOMAT	G56985 ¹⁰

SPIRIT

89-95	Todos	G55526	142567 142568 ⁶⁴ 142880 ⁵⁴ 142933 ⁵⁶ 142940 ⁶⁶	69632	81459	49369 ⁷
91-92	R/T	G55526	142567 142568 ⁶⁴ 142880 ⁵⁴ 142933 ⁵⁶ 142940 ⁶⁶	69632	81459	42459 49369 ⁷

SPIRIT READYMOUNTS

		Delantero	Trasero
89-95	Exc. Sistema de Autonivelación NIVOMAT	G56985 ¹⁰

SPIRIT RT

93-95	Todos	G55526	55526	69632
89-90	Todos	G55526	55526	69632

SPRINTER 2500

03-06	Todos	G56778
	Exc. Doble Rodada Trasera	G56778	G63918

SPRINTER 3500

03-06	Todos	G56778
	Doble Rodada Trasera	G56778	G63919
	Exc. Doble Rodada Trasera	G56778	G63918

ST. REGIS

79-81	Todos	81153	69703	81338	43138 ⁸
-------	-------	------	-------	------	------	------	-------	-------	------	------	--------------------

STEALTH

91-96	Todos	142419 ⁵³
-------	-------	------	------	------	------	------	------	------	------	----------------------	------

7 Paquetes en pares; kit de mangueras de aire incluido

40 Strut ReadyMount. Ensemble Completo

54 Kit con Montaje y Rodamiento. Es probable que reutilizar algunas partes del E.O.

64 El Kit de Montaje incluye: Aislador de Goma del Asiento de Resorte. Es probable reutilizar algunas partes del E.O.

8 Paquetes en pares





53 Montaje de Strut. Es probable reutilizar algunas partes del E.O.

56 El Kit de Montaje incluye: Montaje, Parachoques y Retenedores. Es probable reutilizar algunas partes del E.O.

66 Asiento de Resorte Superior con Espaciador. Es probable reutilizar algunas partes del E.O.

Texto en Negritas - Número de Parte Nuevo / Futuro















AMORTIGUADORES Y STRUTS

Año	Notas de Aplicación										
			Ultra	ProGuard\ Guardian	LTV\ Max Control	Protector de Strut\ Bases de Strut	HiJacker\ Soporte\ Hidráulico		Ultra	ProGuard\ Guardian	LTV\ Max Control

DODGE

DODGE





STRATUS

01-06	Sedan		G51267		G51268	143321 ⁵³ 143423
01-05	Coupe, ST(Cdigo plataforma del fabricante) Izquierdo		G56552	143087 ⁵³		G51254	142419 ⁵³
	Coupe, ST(Cdigo plataforma del fabricante) Derecho		G56551	143087 ⁵³		G51254	142419 ⁵³
99-00	Todos			143328 ⁵³ 143423
	Sedan		G51267		G51268	143328 ⁵³ 143423
97-98	Todos		G51796		G51078
95-96	Todos		G55818		G51078















STRATUS READYMOUNTS

		Delantero		Trasero	
01-06	Sedan	G57026 ¹⁰
01-05	Coupe Izquierdo	G57073 ⁴⁰	G57075 ¹⁰
	Coupe Derecho	G57074 ⁴⁰	G57075 ¹⁰
99-00	Todos	G57025 ¹⁰

TRUCK

59-60	Todos		82065		82054
53-58	Todos		82065		82065





VAN 1/2 TON, A / B SERIES / RAM

99-03	109.3(WheelBase) Exc. PBV 7000#		G63359 ³⁵	61523 ³⁵ 81096 ³⁵	58359 ³⁵ 77359 ³⁵	34052 ⁸		G63413	61522 ⁶ 81496	58413 77413	43085 ⁸ 49212 ⁷
82-98	109.6(WheelBase) Exc. PBV 7000#		G63359 ³⁵	61523 ³⁵ 81096 ³⁵	58359 ³⁵ 77359 ³⁵	34052 ⁸		G63413	61522 ⁶ 81496	58413 77413	43085 ⁸ 49212 ⁷
81	109.6(WheelBase) Exc. PBV 7000#		G63359 ³⁵	61523 ³⁵ 81096 ³⁵	58359 ³⁵ 77359 ³⁵		G63413	61522 ⁶ 81496	58413 77413	43085 ⁸
71-80	Todos		61523 ³⁵ 81096 ³⁵	58359 ³⁵ 77359 ³⁵	34052 ⁸		G63413	61522 ⁶ 81496	58413 77413	43085 ⁸ 49212 ⁷
	Exc. Eje Delantero 4000#		G63359 ³⁵	61523 ³⁵ 81096 ³⁵	58359 ³⁵ 77359 ³⁵	34052 ⁸		G63413	61522 ⁶ 81496	58413 77413	43085 ⁸ 49212 ⁷
64-70	Todos			82065
	Van		81469		81469 82065





VAN 1/2 TON, A / B SERIES / RAM ESTABILIZADORES DE DIRECCIÓN

		Delantero		Trasero	
71-87	Estabilizador de Dirección Sistema Sencillo	6803SE ⁸⁴
71	Estabilizador de Dirección Sistema Sencillo c/ Eje de Viga en I	6802SE ⁸⁴

VAN 1/2 TON, P SERIES

68	Todos			82046
62-64	Todos			82046

VAN 3/4 TON, A / B SERIES / RAM

93-03	Todos		G63359 ³⁵	61523 ³⁵ 81096 ³⁵	58359 ³⁵ 77359 ³⁵	34052 ⁸		G63413	61522 ⁶ 81496	58413 77413	43085 ⁸ 49212 ⁷
92	Todos		G63359	61523 ³⁵ 81096 ³⁵	58359 ³⁵ 77359 ³⁵	34052 ⁸		G63413	61522 ⁶ 81496	58413 77413	43085 ⁸ 49212 ⁷

6 Se recomienda que cuando se reemplacen amortiguadores "quad", los 4 sean de la misma serie.

8 Paquetes en pares

40 Strut ReadyMount. Ensemble Completo

63 El Kit de Montaje incluye: Aislador Parachoques. Es probable reutilizar algunas partes del E.O.

Texto en Negritas - Número de Parte Nuevo / Futuro

7 Paquetes en pares; kit de mangueras de aire incluido

35 Es necesaria apertura en brazo de control para instalar el producto fabricado antes de agosto 1988.

53 Montaje de Strut. Es probable reutilizar algunas partes del E.O.

84 Amortiguador de repuesto para los vehículos con el kit de montaje aftermarket GRC

AMORTIGUADORES Y STRUTS

Año	Notas de Aplicación	From					New				
		Ultra	ProGuard\ Guardian	LTV\ Max Control	Protector de Strut\ Bases de Strut	HiJacker\ Soporte\ Hidráulico	Ultra	ProGuard\ Guardian	LTV\ Max Control	Protector de Strut\ Bases de Strut	HiJacker\ Soporte\ Hidráulico

DODGE

DODGE

VAN 3/4 TON, A / B SERIES / RAM (cont)

81-91	Todos	⊕	G63359 ³⁵	61523 ³⁵ 81096 ³⁵	58359 ³⁵ 77359 ³⁵	34052 ⁸	⊕	G63413	61522 ⁸ 81496	58413 77413	43085 ⁸ 49212 ⁷
71-80	Todos	⊕	61523 ³⁵ 81096 ³⁵	58359 ³⁵ 77359 ³⁵	34052 ⁸	⊕	G63413	61522 ⁸ 81496	58413 77413	43085 ⁸ 49212 ⁷
	Exc. Eje Delantero 4000#	⊕	G63359 ³⁵	61523 ³⁵ 81096 ³⁵	58359 ³⁵ 77359 ³⁵	34052 ⁸	⊕	G63413	61522 ⁸ 81496	58413 77413	43085 ⁸ 49212 ⁷

VAN 3/4 TON, A / B SERIES / RAM ESTABILIZADORES DE DIRECCIÓN

		Delantero	Trasero
80-87	Estabilizador de Dirección Sistema Sencillo	6803SE ⁸⁴
78-79	Van Charger Special	6803SE ⁸⁴
71-77	Estabilizador de Dirección Sistema Sencillo	6803SE ⁸⁴
71	Estabilizador de Dirección Sistema Sencillo c/ Eje de Viga en I	6802SE ⁸⁴

VAN 3/4 TON, P SERIES

69-72	Todos	⊕	⊕	82054
-------	-------	---	------	------	------	------	------	---	------	-------	------	------	------

VAN 1 TON, A / B SERIES / RAM

99-03	Todos	⊕	G63359 ³⁵	61523 ³⁵ 81096 ³⁵	58359 ³⁵ 77359 ³⁵	34052 ⁸	⊕	G63413	61522 ⁸ 81496	58413 77413	43085 ⁸ 49212 ⁷
95-98	Exc. Eje Delantero 4000#	⊕	G63359 ³⁵	61523 ³⁵ 81096 ³⁵	58359 ³⁵ 77359 ³⁵	34052 ⁸	⊕	G63413	61522 ⁸ 81496	58413 77413	43085 ⁸ 49212 ⁷
94	Todos	⊕	⊕	61522 ⁸ 81496	58413	43085 ⁸ 49212 ⁷
	Exc. Eje Delantero 4000#	⊕	G63359 ³⁵	61523 ³⁵ 81096 ³⁵	58359 ³⁵ 77359 ³⁵	34052 ⁸	⊕	G63413	61522 ⁸ 81496	77413 58413	43085 ⁸ 49212 ⁷
72-93	Todos	⊕	70176	⊕
	Todos	⊕	70176	⊕	G63413	61522 ⁸ 81496	58413 77413	43085 ⁸ 49212 ⁷
	Con Eje Delantero 4000#	⊕	G63360	61650 81834	58360	70176	⊕
	Exc. Eje Delantero 4000#	⊕	G63359 ³⁵	61523 ³⁵ 81096 ³⁵	58359 ³⁵ 77359 ³⁵	34052 ⁸ 70176	⊕
71	Todos	⊕	⊕	G63413	61522 ⁸ 81496	58413 77413	43085 ⁸ 49212 ⁷
	Con Eje Delantero 4000#	⊕	G63360	61650 81834	58360	⊕	G63413	61522 ⁸ 81496	58413 77413	43085 ⁸ 49212 ⁷
	Exc. Eje Delantero 4000#	⊕	G63359 ³⁵	61523 ³⁵ 81096 ³⁵	58359 ³⁵ 77359 ³⁵	34052 ⁸	⊕	G63413	61522 ⁸ 81496	58413 77413	43085 ⁸ 49212 ⁷

VAN 1 TON, A / B SERIES / RAM ESTABILIZADORES DE DIRECCIÓN

		Delantero	Trasero
71-87	Estabilizador de Dirección Sistema Sencillo	6803SE ⁸⁴
71	Estabilizador de Dirección Sistema Sencillo c/ Eje de Viga en I	6802SE ⁸⁴

VAN 1 TON, P SERIES

66-72	Todos	⊕	⊕	82065
61-64	Todos	⊕	⊕	82065

VAN, CB300

78-80	Todos	⊕	⊕	G63413	61522 ⁸ 81496	58413	43085 ⁸ 49212 ⁷
	Con Eje Delantero 4000#	⊕	G63360	61650 81834	⊕	G63413	61522 ⁸ 81496	58413	43085 ⁸ 49212 ⁷
	Exc. Eje Delantero 4000#	⊕	G63359 ³⁵	61523 ³⁵ 81096 ³⁵	58359 ³⁵ 77359 ³⁵	34052 ⁸	⊕	G63413	61522 ⁸ 81496	58413	43085 ⁸ 49212 ⁷
	PBV arriba de 8300#	⊕	58360	⊕	G63413	61522 ⁸ 81496	77413 58413	43085 ⁸ 49212 ⁷
77	Todos	⊕	⊕	G63413	61522 ⁸ 81496	58413	43085 ⁸



6 Se recomienda que cuando se reemplacen amortiguadores "quad", los 4 sean de la misma serie.

8 Paquetes en pares

84 Amortiguador de repuesto para los vehículos con el kit de montaje aftermarket GRC

7 Paquetes en pares; kit de mangueras de aire incluido
35 Es necesaria abertura en brazo de control para instalar el producto fabricado antes de agosto 1988.

AMORTIGUADORES Y STRUTS

Año	Notas de Aplicación										
		Ultra	ProGuard\ Guardian	LTV\ Max Control	Protector de Strut\ Bases de Strut	HiJacker\ Soporte\ Hidráulico	Ultra	ProGuard\ Guardian	LTV\ Max Control	Protector de Strut\ Bases de Strut	HiJacker\ Soporte\ Hidráulico

DODGE

DODGE

VAN, CB300 (cont)

77	Con Eje Delantero 4000#	⊥	G63360	61650 81834	⊥	G63413	61522 ⁶ 81496	58413	43085 ⁵
	Exc. Eje Delantero 4000#	⊥	G63359 ³⁵	61523 ³⁵ 81096 ³⁵	77359 ³⁵	⊥	G63413	61522 ⁶ 81496	58413	43085 ⁵
	Hasta PBV 8300#	⊥	58359 ³⁵	34052 ⁸	⊥	G63413	61522 ⁶ 81496	58413	43085 ⁵
	PBV arriba de 8300#	⊥	58360	⊥	G63413	61522 ⁶ 81496	77413 58413	49212 ⁷ 43085 ⁵
75-76	Todos	⊥	⊥	G63413	61522 ⁶ 81496	58413	43085 ⁵ 49212 ⁷
	Con Eje Delantero 4000#	⊥	G63360	61650 81834	⊥	G63413	61522 ⁶ 81496	58413	43085 ⁵ 49212 ⁷
	Exc. Eje Delantero 4000#	⊥	G63359 ³⁵	61523 ³⁵ 81096 ³⁵	77359 ³⁵	⊥	G63413	61522 ⁶ 81496	58413	43085 ⁵ 49212 ⁷
	Hasta PBV 8300#	⊥	58359 ³⁵	34052 ⁸	⊥	G63413	61522 ⁶ 81496	58413	43085 ⁵ 49212 ⁷
74	Todos	⊥	⊥	G63413	61522 ⁶ 81496	58413	43085 ⁵
	Con Eje Delantero 4000#	⊥	G63360	61650 81834	⊥	G63413	61522 ⁶ 81496	58413	43085 ⁵
	Exc. Eje Delantero 4000#	⊥	G63359 ³⁵	61523 ³⁵ 81096 ³⁵	77359 ³⁵	⊥	G63413	61522 ⁶ 81496	58413	43085 ⁵
	Hasta PBV 8300#	⊥	58359 ³⁵	34052 ⁸	⊥	G63413	61522 ⁶ 81496	58413	43085 ⁵
	PBV arriba de 8300#	⊥	58360	⊥	G63413	61522 ⁶ 81496	77413 58413	49212 ⁷ 43085 ⁵

VERNA

03-06	Izquierdo	⊥	G56895	⊥	G56897
	Derecho	⊥	G56896	⊥	G56898

EAGLE

EAGLE

2000 GTX

91-93	Todos	⊥	G55945	⊥	G51046	142419 ⁵³
	Exc. Sistema de Autonivelación	⊥	G55605	⊥	G51424 G51046	142419 ⁵³

SUMMIT

93-96	Todos	⊥	⊥	142419 ⁵³
	Coupe	⊥	G55911	142329 ⁵³	⊥	G51063	142419 ⁵³
	Sedan	⊥	G55911	142329 ⁵³	⊥	G51063	142419 ⁵³
	Wagon	⊥	G55605	⊥	69462	142419 ⁵³
89-92	Sedan	⊥	G55592	⊥	G51249	142419 ⁵³
92	Hatchback	⊥	⊥	G51249
	Wagon	⊥	G55605	⊥	69462	142419 ⁵³
91	Todos	⊥	⊥	G51249
89-90	Todos	⊥	G55592	⊥	G51249

6 Se recomienda que cuando se reemplacen amortiguadores "quad", los 4 sean de la misma serie.

8 Paquetes en pares

53 Montaje de Strut. Es probable reutilizar algunas partes del E.O.

7 Paquetes en pares; kit de mangueras de aire incluido

35 Es necesaria abertura en brazo de control para instalar el producto fabricado antes de agosto 1988.

AMORTIGUADORES Y STRUTS

Año	Notas de Aplicación	Front					Rear				
		Ultra	ProGuard\ Guardian	LTV\ Max Control	Protector de Strut\ Bases de Strut	HiJacker\ Soporte\ Hidráulico	Ultra	ProGuard\ Guardian	LTV\ Max Control	Protector de Strut\ Bases de Strut	HiJacker\ Soporte\ Hidráulico

EAGLE

EAGLE

TALON

95-98	Todos	G55819	142419 ⁵³	142419 ⁵³
	AWD	G55819	142419 ⁵³	G51712	142419 ⁵³
	FWD	G55819	142419 ⁵³	G51254	142419 ⁵³
91-94	Todos	G55605	142219 ⁵³	142419 ⁵³
	AWD, Sistema Autonivelable	G55605	142219 ⁵³	G51046	142419 ⁵³
	FWD	G55605	142219 ⁵³	G51184	142419 ⁵³
90	Todos	142219 ⁵³	142419 ⁵³
	AWD, Sistema Autonivelable	142219 ⁵³	G51046	142419 ⁵³
	AWD, FWD	G55587	142219 ⁵³	142419 ⁵³
	FWD	142219 ⁵³	G51184	142419 ⁵³

VISION

93-97	Izquierdo	G55663	142755 ⁶ 142842 ⁵⁴	G55665
	Derecho	G55664	142755 ⁶ 142842 ⁵⁴	G55665

VISION READYMOUNTS

		Delantero		Trasero	
93-97	Izquierdo	G56958 ⁴⁰		G56960 ⁴⁰	
	Derecho	G56959 ⁴⁰		G56960 ⁴⁰	

VISTA

89-92	Exc. Wagon	G55561
90-91	4WD	81739
89-91	FWD, Wagon	69689	81464
89	4WD, Wagon	81739

EDSEL

EDSEL

BERMUDA

58	Todos	82099
----	-------	------	-------	------	------	------	------	------	------

CITATION

58	Todos	82099
----	-------	------	-------	------	------	------	------	------	------

CORSAIR

58-59	Todos	82099	82076
	Exc. Wagon	82099	81469 82076

PACER

58	Todos	82099
----	-------	------	-------	------	------	------	------	------	------

RANGER

58-60	Todos	82099	82076
-------	-------	------	-------	------	------	------	------	-------	------

6 Se recomienda que cuando se reemplacen amortiguadores "quad", los 4 sean de la misma serie.





53 Montaje de Strut. Es probable reutilizar algunas partes del E.O.

Texto en Negritas - Número de Parte Nuevo / Futuro

40 Strut ReadyMount. Ensamble Completo

54 Kit con Montaje y Rodamiento. Es probable que reutilizar algunas partes del E.O.



AMORTIGUADORES Y STRUTS

Año	Notas de Aplicación										
			Ultra	ProGuard\ Guardian	LTV\ Max Control	Protector de Strut\ Bases de Strut	HiJacker\ Soporte\ Hidráulico		Ultra	ProGuard\ Guardian	LTV\ Max Control



EDSEL

EDSEL



RANGER (cont)

58-59	Exc. Wagon		82099		81469 82076
-------	------------	---	------	-------	------	------	------	---	------	----------------	------	------	------

ROUNDUP

58	Todos		82099	
----	-------	---	------	-------	------	------	------	---	------	------	------	------	------









VILLAGER

58-60	Todos		82099		82076
58-59	Exc. Wagon		82099		81469 82076





FIAT

FIAT





124

76-79	Fabricados después de la Serie #066.059		82614	
76	Wagon			82156
67-75	Todos		82614	
	Wagon		82614		82156

500

09-12	Izquierdo		G52491		70103
	Derecho		G52492		70103







1100

66-67	Exc. Wagon			82155
	Wagon			82156

1500

64-67	Exc. Wagon			82155
	Wagon			82156











PALIO

05-08	Adventure			70087
04-08	Izquierdo		G52043	143288		70004
	Derecho		G52043	143289		70004



FORD

FORD

AEROSTAR

90-97	Todos			G63502	61557 81727	49221 ⁷
	AWD		G63621	61569 81826		G63502	61557 81727	49221 ⁷
	RWD		G63457	61540 81582		G63502	61557 81727	49221 ⁷
89	RWD		G63457	61540 81582		G63502	61557 81727	49221 ⁷
86-88	RWD		G63457	61540 81582		G63490	61541 81583

ASPIRE

94-97	Non-ABS		G55615		G51039
-------	---------	---	--------	------	------	------	------	---	--------	------	------	------	------

AMORTIGUADORES Y STRUTS

Año	Notas de Aplicación	From					Rear				
		Ultra	ProGuard\ Guardian	LTV\ Max Control	Protector de Strut\ Bases de Strut	HiJacker\ Soporte\ Hidráulico	Ultra	ProGuard\ Guardian	LTV\ Max Control	Protector de Strut\ Bases de Strut	HiJacker\ Soporte\ Hidráulico

FORD

FORD

B100

79-81	5L 8Cyl (302) FI	○	G63500	61553	42971	○	61518 81242
	5L FI	↓	42971	↓
79	4.7L 8Cyl (289) 4WD; MFI	○	G63500	61553	42971	○	61518 81242
	4.7L MFI	↓	42971	↓
73-74	Todos	↓	42971	↓
	4.7L 8Cyl (289) 4WD; MFI	○	G63500	61553	42971	○	61519 81484
	5.0L FI	↓	42971	↓
74	5L 8Cyl (302) FI	○	G63500	61553	42971	○	61519 81242
73	5L 8Cyl (302) FI	○	G63500	61553	42971	○	61519 81484

B150

83-85	3.8L 6Cyl (232) RWD; 4BBL	○	G63414	61520 81490	42967	○	G63409	61518 81710
82-85	5L 8Cyl (302) FI	○	G63414	61520 81490	42967	○	G63409	61518 81710
82	3.8L 6Cyl (232) RWD; 4BBL	○	G63414	61553 81490	42967	○	G63409	61518 81710
75-78	4.7L 8Cyl (289) 4WD; MFI	○	G63500	61553	42971	○	61518 81242
	4WD; 4.7 L & 5L FI	○	81694	○
	5L 8Cyl (302) FI	○	G63500	61553	42971	○	61518 81242

B200

92	5L 8Cyl (302) FI	○	G63414	61520 81490	42967	○	61547 81082
85-91	5L 8Cyl (302) FI	○	G63386	61521 81394	○	81285

BRONCO

97	Todos	○	G63414	61520 81490	○	61554
	2.9L 2BBL	○	G63414	61520 81490	42967	○	61554
80-96	Con o sin Suspensión Quad detrás del Eje Delantero; Exc. Kit de Levantamiento	○	G63414 ⁶	61520 ⁶ 81490	58414 ⁶ 77414 ⁶	34057 ⁸	○
	Exc. Kit de Levantamiento	○	○	G63409	61554 81710	58409 77409 ⁶	43142 ⁸ 49197 ⁷
	Suspensión Quad adelante del Eje Delantero; Exc. Kit de Levantamiento	○	G63410 ⁶	61546 ⁶	77410 ⁶	○
80-88	Kit de Levantamiento de 3-4"	○	○	G63441 ⁵⁰
80-86	Kit de Levantamiento de 3-4", Suspensión Quad adelante del Eje Delantero	○	G63446 ⁶	○
	Kit de Levantamiento de 3-4", Suspensión Quad detrás del Eje Delantero	○	G63445 ⁶	○
78-79	Exc. Kit de Levantamiento	○	○	G63377	61519 81484	58377 77377	43058 ⁸ 49127 ⁷
	Izquierdo Kit de Levantamiento de 3 1/2-4" Exc. Suspensión Quad	○	G63447	○	G63441 ⁵⁰
	Derecho Kit de Levantamiento de 3 1/2-4" Exc. Suspensión Quad	○	G63445	○	G63441 ⁵⁰





6 Se recomienda que cuando se reemplacen amortiguadores "quad", los 4 sean de la misma serie.

7 Paquetes en pares; kit de mangueras de aire incluido

8 Paquetes en pares

50 Para proteger la barra del pistón, se recomienda utilizar el kit Bellows No.141242.













AMORTIGUADORES Y STRUTS

Año	Notas de Aplicación										
			Ultra	ProGuard\ Guardian	LTV\ Max Control	Protector de Strut\ Bases de Strut	HiJacker\ Soporte\ Hidráulico		Ultra	ProGuard\ Guardian	LTV\ Max Control

FORD

FORD









BRONCO (cont)

78-79	Suspensión Quad adelante del Eje Delantero; Exc. Kit de Levantamiento		61551 ⁶		
	Suspensión Quad Amortiguador Largo; Exc. Kit de Levantamiento		G63511 ⁶		
	Suspensión Quad; detrás del Eje Delantero; Exc. Kit de Levantamiento		G63396 ⁶	61521 ⁶ 81394		
67-77	Desde Serie #830001; Exc. Kit de Levantamiento		G63386	61521 ⁶ 81394	58386	34058 ⁸		G63377	61519 81484	58377 77377	43058 ⁸ 49127 ⁷
66-77	Kit de Levantamiento de 4-5"		G63445		G63441 ⁵⁰
66	Desde Serie #830001; Exc. Kit de Levantamiento		61521 ⁶	58386	34058 ⁸		G63377	61519 81484	58377 77377	43058 ⁸
	Exc. Kit de Levantamiento		G63386	81394	
	Toda la serie #830000			G63350	61518 81242	58350	43099 ⁸ 49173 ⁷

BRONCO ESTABILIZADORES DE DIRECCIÓN

		Delantero		Trasero	
92-96	Estabilizador de Dirección Sistema Sencillo	6802SE ⁸⁴		
80-91	Todos	6802SE ⁸⁴		
78-79	Estabilizador de Dirección Sistema Dual; Exc. Barra Estabilizadora	6802SE ⁸⁴		
71-79	Todos	14016		
	Estabilizador de Dirección Sistema Sencillo	6803SE ⁸⁴		
70	Estabilizador de Dirección Sistema Sencillo	6803SE ⁸⁴		
68-69	Estabilizador de Dirección Sistema Sencillo	6804SE ⁸⁰		
67	Todos	14016		
	Estabilizador de Dirección Sistema Sencillo	6804SE ⁸⁰		
66	Estabilizador de Dirección Sistema Sencillo	6804SE ⁸⁰		







BRONCO II

90	Todos		G63614	61561 81744	58929 77614		G63525	61559 81730	77525	49223 ⁷
89	Fab. desde 2/89; Vehículos con perno de 12mm en montaje inferior trasero		77414 ⁶		G63525	61559 81730	77525	49223 ⁷
	Fab. hasta 2/89; Vehículos con perno 10mm y 12mm en montaje inferior trasero		G63414	61520 ⁶ 81490	34057 ⁸		G63427	61533 81539	43165 ⁸ 49207 ⁷
84-88	Con Perno de 10mm en Montaje Inferior Trasero		G63414	61520 ⁶ 81490	77414 ⁶	34057 ⁸		G63427	61533 81539	43165 ⁸ 49207 ⁷

BRONCO II ESTABILIZADORES DE DIRECCIÓN

		Delantero		Trasero	
84-90	Estabilizador de Dirección Sistema Sencillo	6802SE ⁸⁴		

CONTOUR

97-00	Fab. desde 3/97		G56520	142843 ⁵⁴		G55693	142402 ⁵³
95-00	Todos		142843 ⁵⁴		G55693	142402 ⁵³
95-97	Fab. hasta 3/97		G55692	142843 ⁵⁴		G55693	142402 ⁵³

CONTOUR READYMOUNTS

		Delantero		Trasero	
99-00	Base, LX, Power, SE		G57052 ¹⁰	
96-98	Base, GL, LX, Power, SE, Sport		G57052 ¹⁰	
95	GL, LX, SE		G57052 ¹⁰	

6 Se recomienda que cuando se reemplacen amortiguadores "quad", los 4 sean de la misma serie.

8 Paquetes en pares

50 Para proteger la barra del pistón, se recomienda utilizar el kit Bellows No.141242.

54 Kit con Montaje y Rodamiento. Es probable que reutilizar algunas partes del E.O.

84 Amortiguador de repuesto para los vehículos con el kit de montaje aftermarket GRC

Texto en Negritas - Número de Parte Nuevo / Futuro



7 Paquetes en pares; kit de mangueras de aire incluido

40 Strut ReadyMount. Ensemble Completo

53 Montaje de Strut. Es probable reutilizar algunas partes del E.O.

80 No requiere soportes para el montaje, instalar sobre montajes de EO Veá Ref. C para Botas.

AMORTIGUADORES Y STRUTS

Año	Notas de Aplicación										
		Ultra	ProGuard\ Guardian	LTV\ Max Control	Protector de Strut\ Bases de Strut	HiJacker\ Soporte\ Hidráulico	Ultra	ProGuard\ Guardian	LTV\ Max Control	Protector de Strut\ Bases de Strut	HiJacker\ Soporte\ Hidráulico

FORD

COUGAR

92-96	Todos	69845	81795
90-91	Todos	69820	81461
89	Todos	69820

FORD

COUNTRY SEDAN

65-74	Todos	69675 ⁵	81446	34073 ⁸	69606	81495	43140 ⁶ 49205 ⁷
60-64	Todos	...	82099	82076
57-59	Todos	...	82099	81270	49105 ⁷
52-56	Todos	...	82026	81270	49105 ⁷
50-51	Todos	...	82026	82156

COUNTRY SQUIRE

87-91	Todos	69675 ⁵	81446	34073 ⁸	69606	81495	43140 ⁶ 49205 ⁷
65-74	Todos	69675 ⁵	81446	34073 ⁸	69606	81495	43140 ⁶ 49205 ⁷
59-64	Todos	...	82099	82076
57-58	Todos	...	82099
52-56	Todos	...	82026	81270	49105 ⁷
50-51	Todos	...	82026	82060

COURIER

00-10	Todos	G56749	G64083	61674
72-82	Todos	G63421	61504 81750	58421 77421	82125

COURIER SEDAN DELIVERY

59-60	Todos	...	82099	82076
57-58	Todos	...	82099
54-56	Todos	...	82026	81270	49105 ⁷

CRESTLINE

52-54	Todos	...	82026	81270	49105 ⁷
50-51	Todos	...	82026	82156

CROWN VICTORIA

07-11	Todos	143356 ⁵³ 143357 ⁶⁸
	Exc. Modelos Policía y Taxi	G51887	143356 ⁵³ 143357 ⁶⁸	...	69575
11	Modelos Policía y Taxi	G51888	143356 ⁵³ 143357 ⁶⁸
07-10	Modelos Policía y Taxi	G51888	143356 ⁵³ 143357 ⁶⁸	...	69574	...	77955
03-06	Todos	143356 ⁵³

5 Use el kit 140719 para reemplazar partes del EO de montaje inferior cuando los pernos se rompan o los tornillos autoroscantes no se puedan utilizar más.

8 Paquetes en pares

68 Kit de Accesorios de Montaje. Aislador de Goma del Asiento de Resorte. Es probable reutilizar algunas partes del E.O.

7 Paquetes en pares; kit de mangueras de aire incluido

53 Montaje de Strut. Es probable reutilizar algunas partes del E.O.

AMORTIGUADORES Y STRUTS

Año	Notas de Aplicación	Front					Rear				
		Ultra	ProGuard\ Guardian	LTV\ Max Control	Protector de Strut\ Bases de Strut	HiJacker\ Soporte\ Hidráulico	Ultra	ProGuard\ Guardian	LTV\ Max Control	Protector de Strut\ Bases de Strut	HiJacker\ Soporte\ Hidráulico

FORD

FORD

CROWN VICTORIA (cont)

03-06	Exc. Modelos Policía y Taxi	I	G51887	143357 ⁹⁸ 143356 ⁹³
	Modelos Policía y Taxi	I	G51888	143356 ⁹³	77955
93-02	Modelos Policía y Taxi	I	G63375 ⁵	61555 81713 ⁵	77375	43140 ⁹ 49205 ⁷
92-02	Todos	I	69675 ⁵	43140 ⁹ 49205 ⁷
	Exc. Sistema de Autonivelación NIVOMAT	I	69675 ⁵	43140 ⁹ 49205 ⁷
	Exc. Modelos Policía y Taxi	I	69675 ⁵	81446	43140 ⁹ 49205 ⁷

CROWN VICTORIA READYMOUNTS

		Delantero		Trasero	
03-11	Exc. Modelos Policía y Taxi	G57080⁴⁰		

CUSTOM

65-72	Todos	I	69675 ⁵	81446	43140 ⁹ 49205 ⁷
64	Todos	I	82099
57	Todos	I	82099	49105 ⁷
52	Todos	I	82026	49105 ⁷
50-51	Todos	I	82026

CUSTOM 300

60	Todos	I	82099
59	Todos	I	82099
58	Todos	I	82099	49105 ⁷

CUSTOM 500

68-77	Todos	I	69675 ⁵	81446	43140 ⁹ 49205 ⁷
-------	-------	---	--------------------	-------	------	------	------	------	------	------	--

CUSTOMLINE

52-56	Todos	I	82026	49105 ⁷
-------	-------	---	------	-------	------	------	------	------	------	------	--------------------

DEL RIO WAGON

57-58	Todos	I	82099
-------	-------	---	------	-------	------	------	------	------	------	------	------

DELUXE

49-51	Todos	I	82026
47-48	Amortiguadores de Acción Directa	O	82007

E-550 ECONOLINE SUPER DUTY

02	Todos	O	61655
----	-------	---	------	------	------	------	------	------	------	------	-------

E-550 SUPER DUTY

03	Todos	O	61655
----	-------	---	------	------	------	------	------	------	------	------	-------

ECONOLINE

61-67	Todos	O	G63492	61506 81318	77492	G63299
-------	-------	---	--------	----------------	-------	------	------	------	------	------	--------

5 Use el kit 140719 para reemplazar partes del EO de montaje inferior cuando los pernos se rompan o los tornillos autoroscantes no se puedan utilizar más.

8 Paquetes en pares

53 Montaje de Strut. Es probable reutilizar algunas partes del E.O.

Texto en Negritas - Número de Parte Nuevo / Futuro

7 Paquetes en pares; kit de mangueras de aire incluido

40 Strut ReadyMount. Ensamble Completo

68 Kit de Accesorios de Montaje. Aislador de Goma del Asiento de Resorte. Es probable reutilizar algunas partes del E.O.

AMORTIGUADORES Y STRUTS

Año	Notas de Aplicación	Front					Rear				
		Ultra	ProGuard\ Guardian	LTV\ Max Control	Protector de Strut\ Bases de Strut	HiJacker\ Soporte\ Hidráulico	Ultra	ProGuard\ Guardian	LTV\ Max Control	Protector de Strut\ Bases de Strut	HiJacker\ Soporte\ Hidráulico

FORD

FORD

ECONOLINE VAN ESTABILIZADORES DE DIRECCIÓN

		Delantero	Trasero
61-67	Van	6802SE ⁸⁴

ECONOLINE WAGON

99-02	4.2L 6Cyl (256) 4WD; 2BBL	↓	G63622	↓	61646 81828
	5L 8Cyl (305) FI	↓	G63622	↓	61646 81828

ECOSPORT

10-11	Todos	↓	G52316	↓
09	Todos	↓	G52316	↓
07-08	Todos	↓	G52041	143285	↓	G51800
06	Todos	↓	G52041	143285	↓	G51800
05	Todos	↓	G52041	143285	↓	G51800
04	Todos	↓	G52041	143285	↓	G51800

EDGE

11-14	Izquierdo	↓	G52351	↓	G64111
	Derecho	↓	G52352	↓	G64111
07-10	Izquierdo	↓	G56840	143415	↓	G64037
	Derecho	↓	G56841	143415	↓	G64037

ESCAPE

14-16	Todos	↓	↓	G511001
13	Izquierdo	↓	G52420	↓	G511001
	Derecho	↓	G52421	↓	G511001
12	Izquierdo	↓	G56601	143253 ⁵³	↓	G511001 G64047
	Derecho	↓	G56568	143253 ⁵³	↓	G511001 G64047
08-11	Izquierdo	↓	G56601	143253 ⁵³	↓	G64047
	Derecho	↓	G56568	143253 ⁵³	↓	G64047
01-07	Izquierdo	↓	G56601	143253 ⁵³	↓	69900 G63862
	Derecho	↓	G56568	143253 ⁵³	↓	69900 G63862

ESCAPE READYMOUNTS

		Delantero	Trasero
01-12	Izquierdo	G57045 ⁴⁰
	Derecho	G57046 ⁴⁰

40 Strut ReadyMount. Ensamble Completo

84 Amortiguador de repuesto para los vehículos con el kit de montaje aftermarket

GRC

Texto en Negritas - Número de Parte Nuevo / Futuro

53 Montaje de Strut. Es probable reutilizar algunas partes del E.O.

AMORTIGUADORES Y STRUTS

Año	Notas de Aplicación	Front					Rear				
		Ultra	ProGuard\ Guardian	LTV\ Max Control	Protector de Strut\ Bases de Strut	HiJacker\ Soporte\ Hidráulico	Ultra	ProGuard\ Guardian	LTV\ Max Control	Protector de Strut\ Bases de Strut	HiJacker\ Soporte\ Hidráulico

FORD

FORD

ESCORT

98-03	Hot y Cool Coupe; Sin ABS	G56801	142744 ⁶⁵ 142832 ⁵⁴	G55848	142190 ⁶³
97-03	Todos	142744 ⁶⁵ 142832 ⁵⁴	G55848	142190 ⁶³
97-02	Exc. Hot y Cool Coupe	G56515	142744 ⁶⁵ 142832 ⁵⁴	G55848	142190 ⁶³
91-96	Todos	G55847	142744 ⁶⁵	G55848	142190 ⁶³
85-90	Fab. desde 3/85	G55714	G55705
81-90	Todos	G55705
83-85	Fab. desde 2/83 hasta 2/85	G55712	G55705

ESCORT READYMOUNTS

		Delantero	Trasero
97-03	Todos	G56940 ⁴⁰
97-02	Exc. Hot y Cool Coupe	G56926 ⁴⁰	G56940 ⁴⁰
91-96	Todos	G56911 ⁴⁰	G56940 ⁴⁰

EXCURSION

00-05	4WD	G63809	77809	G63837	77837
	RWD	G63614	77614	G63607	77607

EXCURSION ESTABILIZADORES DE DIRECCIÓN

		Delantero	Trasero
00-05	4WD, Con Amortiguador de EO	6854SE ⁸⁰

EXP

85-88	Fab. desde 3/85	G55714	G55705
84-88	Todos	G55705
84-85	Fab. desde 2/83 hasta 3/85	G55712	G55705
82-83	Fab. hasta 2/83	G55705
83	Fab. desde 2/83 hasta 3/85	G55712

EXPEDITION

15-16	4WD, RWD	143424 ⁵³
	4WD, RWD, Exc. Suspensión de Aire	143393 ⁵³
	Coil(RearSpringType) Exc. Suspensión de Aire	G51861
10-14	Todos	143424 ⁵³
	Exc. Suspensión de Aire	143424 ⁵³	143393 ⁵³
14	Coil(RearSpringType) Exc. Suspensión de Aire	143424 ⁵³	G51861
10-13	Coil(RearSpringType) Exc. Suspensión de Aire	G51860	143424 ⁵³	G51861
10-12	RWD	143389 143424 ⁵³

40 Strut ReadyMount. Ensamble Completo

54 Kit con Montaje y Rodamiento. Es probable que reutilizar algunas partes del E.O.

80 No requiere soportes para el montaje, instalar sobre montajes de EO Vea Ref. C para Botas.

Texto en Negritas - Número de Parte Nuevo / Futuro

53 Montaje de Strut. Es probable reutilizar algunas partes del E.O.

65 El Kit de Montaje incluye: Asiento de Resorte Superior con Aislador. Es probable reutilizar algunas partes del E.O.

AMORTIGUADORES Y STRUTS

Año	Notas de Aplicación	Front					Rear				
		Ultra	ProGuard\ Guardian	LTV\ Max Control	Protector de Strut\ Bases de Strut	HiJacker\ Soporte\ Hidráulico	Ultra	ProGuard\ Guardian	LTV\ Max Control	Protector de Strut\ Bases de Strut	HiJacker\ Soporte\ Hidráulico

FORD

FORD

EXPEDITION (cont)

07-09	Coil(RearSpringType) Exc. Suspensión de Aire	↓	G51860	↓	G51861
	RWD	↓	143376 143389 143424 ⁵³	↓	143393
03-06	Todos	↓	↓	G51729	143317 ⁵³
	Exc. Suspensión de Aire	↓	143244 ⁵³	↓	G51729	143317 ⁵³
	4WD	↓	G51720	↓	G51729	143317 ⁵³
	RWD	↓	G51719	↓	G51729	143317 ⁵³
97-02	Todos	○	○	G63717	61614	58717 77717
	4WD, Exc. Nivelación Nuemática Delantera	○	G63716	61613 81914	58716 77716	○	G63717	61614	58717 77717
	RWD, Exc. Nivelación Nuemática Delantera	○	G63714	61611 81912	58714 77714	○	G63717	61614	58717 77717
96	4.6L 8Cyl (281) 4WD; 2BBL	○	G63714	○

EXPEDITION ESTABILIZADORES DE DIRECCIÓN

		Delantero	Trasero
97-02	4WD, Barra de Torsion(FrontSpringType)	6861SE ⁸²

EXPEDITION READYMOUNTS

		Delantero	Trasero
14-16	4WD, RWD, Exc. Suspensión de Aire	G57173 ⁴⁰
14	Exc. Suspensión de Aire	G57173 ⁴⁰
12-13	4WD, RWD, Exc. Suspensión de Aire	G57172 ⁴⁰	G57173 ⁴⁰
10-13	Todos	G57172 ⁴⁰
	Exc. Suspensión de Aire	G57172 ⁴⁰	G57173 ⁴⁰
07-09	Todos	G57172 ⁴⁰	G57173 ⁴⁰
03-06	Todos	G57016 ⁴⁰
	4WD	G57015 ⁴⁰	G57016 ⁴⁰

EXPLORER

15-16	Todos	↓	↓	G51980
11-14	Todos	↓	143475 ⁵³	↓	G51980	143475 ⁵³
06-10	Todos	↓	G56838	143330 ⁵³ 143360 ⁵³	↓	G56839	143361 ⁵³ 143362 ⁷⁰
04-05	Exc. Todos los Modelos Sport y Sport Trac	↓	G51723	143318 ⁵³	↓	G51724	143319 ⁵³
02-05	Todos	↓	143318 ⁵³	↓	143319 ⁵³
02-03	Exc. Todos los Modelos Sport y Sport Trac	↓	G51722	143318 ⁵³	↓	G51724	143319 ⁵³
99-01	Exc. Suspensión Electrónica Ajustable	○	61623 81893	○	43171 ⁸ 49232 ⁷
95-01	Exc. Suspensión de Aire	○	G63678	77678	○	G63679	61624 81890	77679
98	Todos	○	G63678	○	G63679	61624 81890
	Exc. Suspensión Electrónica Ajustable	○	G63678	61623 81893	○	G63679	61624 81890	43171 ⁸ 49232 ⁷
95-97	Exc. Suspensión Electrónica Ajustable	○	61623 81893	○	43171 ⁸ 49232 ⁷

7 Paquetes en pares; kit de mangueras de aire incluido

40 Strut ReadyMount. Ensemble Completo

70 Kit Buje y Camisa. Algunos accesorios del Equipo Original podrían ser necesitados





Texto en Negritas - Número de Parte Nuevo / Futuro

8 Paquetes en pares

53 Montaje de Strut. Es probable reutilizar algunas partes del E.O.

82 Use kit si está señalado. Vea Ref. C para Botas.



AMORTIGUADORES Y STRUTS

Año	Notas de Aplicación										
			Ultra	ProGuard\ Guardian	LTV\ Max Control	Protector de Strut\ Bases de Strut	HiJacker\ Soporte\ Hidráulico		Ultra	ProGuard\ Guardian	LTV\ Max Control

FORD

FORD

EXPLORER (cont)

91-94	Todos		G63608	61591 81744	58929 77608	34076 ⁸		G63607	61590 81823	77607	43172 ⁸ 49225 ⁷
-------	-------	---	--------	----------------	----------------	------	--------------------	---	--------	----------------	-------	------	--





EXPLORER ESTABILIZADORES DE DIRECCIÓN

		Delantero	Trasero
95-02	4WD	14077
91-94	Todos	6802SE ⁸⁴

















EXPLORER READYMOUNTS

		Delantero	Trasero
06-10	Todos	G57095 ⁴⁰	G57096 ⁴⁰
04-05	Exc. Todos los Modelos Sport y Sport Trac	G57019 ⁴⁰	G57018 ⁴⁰
02-03	Exc. Todos los Modelos Sport y Sport Trac	G57017 ⁴⁰	G57018 ⁴⁰

EXPLORER SPORT TRAC

07-10	Todos		G52205		G52206
01-05	Todos		G63678	61623 81893	77678		G63679	61624 81890	77679	43171 ⁸ 49232 ⁷

























F SERIES

57-59	Todos		81270	
	F-100, F-250		81270		82123
55	Todos		G63299	
	F-100		G63299		G63405	61500 81147	77405	43048 ⁸ 49310 ⁷
	F250		G63299		81676
53-54	Todos		G63299		81676
48-52	F-1, F-2 y F-3		G63405	61500 81147	77405		G63299	81676
	F-1, F-2 & F-3		43048	

F SERIES ESTABILIZADORES DE DIRECCIÓN

		Delantero	Trasero
57-59	Estabilizador de Dirección Sistema Sencillo c/ Eje de Viga en I	6802SE ⁸⁴
59	Estabilizador de Dirección Sistema Sencillo F-250, F-350 sin Power Steering	6803SE ⁸⁴
50-55	Estabilizador de Dirección Sistema Sencillo c/ Eje de Viga en I	6802SE ⁸⁴

F-200



88-90	5.8L 8Cyl (351) SOHC; FI		G63455	61520 81821	42967		G63409	81710 61614
	RWD 5.8L 8Cyl (351) SOHC; FI		G63414		61614
87-90	5L 8Cyl (302) FI		G63455	61520 81821	42967		G63409	81710 61614
86-90	Todos			61614
	8Cyl SFI		81490		61530 61614
	RWD 5L 8Cyl (302) FI		G63414		61614
86-87	RWD 5.8L 8Cyl (351) SFI		G63414		61614
87	5.8L 8Cyl (351) SFI		61520	42967		61614
	5.8L 8Cyl (351) SOHC; EFI			81710 61614
	5.8L 8Cyl (351) SOHC; FI		G63455	81821		G63409	81710 61614
86	4WD 5.8L 8Cyl (351) SOHC; FI		G63416		61614
	4WD 5L 8Cyl (302) FI		G63416		61614

7 Paquetes en pares; kit de mangueras de aire incluido
40 Strut ReadyMount. Ensemble Completo

8 Paquetes en pares
84 Amortiguador de repuesto para los vehículos con el kit de montaje aftermarket GRC

Texto en Negritas - Número de Parte Nuevo / Futuro

AMORTIGUADORES Y STRUTS

Año	Notas de Aplicación										
		Ultra	ProGuard\ Guardian	LTV\ Max Control	Protector de Strut\ Bases de Strut	HiJacker\ Soporte\ Hidráulico	Ultra	ProGuard\ Guardian	LTV\ Max Control	Protector de Strut\ Bases de Strut	HiJacker\ Soporte\ Hidráulico

FORD

FORD

F-200 (cont)

86	5.8L 8Cyl (351) SFI	⊖	61520	42967	⊖	81710 61614
	5.8L 8Cyl (351) SOHC; FI	⊖	42967	⊖	G63409	81710 61614
	5L 8Cyl (302) FI	⊖	61520	42967	⊖	G63409	81710 61614

F-550

10-12	Todos	⊖	58944	⊖
	Crew Cab	⊖	58944	⊖	58945

F59 ESTABILIZADORES DE DIRECCIÓN

		Delantero		Trasero	
89-91	Estabilizador de Dirección Sistema Sencillo, Superduty Motorhome	6802SE ⁹⁴		

FAIRLANE

66-70	Todos	⊖	82126	⊖	81270	49105 ⁷
	Wagon	⊖	82126	⊖	69606	81270	49105 ⁷
62-65	Todos	⊖	82075	⊖	81270	49105 ⁷
60-61	Todos	⊖	82099	⊖	82076
59	Todos	⊖	82099	⊖
57-58	Todos	⊖	82099	⊖	81270	49105 ⁷
55-56	Todos	⊖	82026	⊖	81270	49105 ⁷

FAIRMONT

78-83	Todos	⊖	G56504 ⁹	142197 ⁵³	⊖	69633	81460	43143 ⁸ 49199 ⁷
-------	-------	---	---------------------	------	------	----------------------	------	---	-------	-------	------	------	--

FALCON

66-70	Todos	⊖	82126	⊖
	Exc. Wagon	⊖	82126	⊖	81270
	Wagon	⊖	82126	⊖	69606
	Exc. Wagon	⊖	82126	⊖	49105 ⁷
	Wagon	⊖	82126	⊖	81495
60-65	Todos	⊖	82126	⊖	81270	49105 ⁷

FESTIVA

88-93	Todos	⊖	G55615	⊖	G51039
-------	-------	---	--------	------	------	------	------	---	--------	------	------	------	------

7 Paquetes en pares; kit de mangueras de aire incluido

8 Paquetes en pares

9 Vea Ref.D para los procedimientos de reemplazo de una Susp. Elect. Ajust. con un producto no ajust.





53 Montaje de Strut. Es probable reutilizar algunas partes del E.O.

84 Amortiguador de repuesto para los vehículos con el kit de montaje aftermarket

GRC

Texto en Negritas - Número de Parte Nuevo / Futuro

















AMORTIGUADORES Y STRUTS

Año	Notas de Aplicación										
			Ultra	ProGuard\ Guardian	LTV\ Max Control	Protector de Strut\ Bases de Strut	HiJacker\ Soporte\ Hidráulico		Ultra	ProGuard\ Guardian	LTV\ Max Control









FORD

FORD









FIESTA

11-13	Izquierdo		G52255	143399		70052	143400
	Derecho		G52256	143399		70052	143400
03-10	Origen Brasil; Exc. Modelos ST		G52042		G51801	143287
01-07	Ikon México		G56749		G51295
98-01	1.3L y 1.4L Dir. hidráulica con amortiguador trasero con montaje inferior tipo anillo		G56749		G51295
	1.3L y 1.4L Dir. hidráulica con amortiguador trasero con montaje inferior tipo horquilla		G56749		G51733
	1.3L y 1.4L Dir. mecánica con amortiguador trasero con montaje inferior tipo anillo		G56742		G51295
	1.3L y 1.4L Dir. mecánica con amortiguador trasero con montaje inferior tipo horquilla		G56742		G51733



FIVE HUNDRED

05-07	AWD, Izquierdo		G52136	
	AWD, Derecho		G52137	
	FWD, Izquierdo		G52138		G51849	143390 ⁵³
	FWD, Derecho		G52139		G51849	143391 ⁵³

FLEX

13-16	Todos			G51996
10-12	Izquierdo		G52384		G51996
	Derecho		G52385		G51996
09	Todos			G51996

FOCUS

14	Todos			G511002
----	-------	---	------	------	------	------	------	---	---------	------	------	------	------

53 Montaje de Strut. Es probable reutilizar algunas partes del E.O.

AMORTIGUADORES Y STRUTS

Año	Notas de Aplicación	Front					Rear				
		Ultra	ProGuard\ Guardian	LTV\ Max Control	Protector de Strut\ Bases de Strut	HiJacker\ Soporte\ Hidráulico	Ultra	ProGuard\ Guardian	LTV\ Max Control	Protector de Strut\ Bases de Strut	HiJacker\ Soporte\ Hidráulico

FORD

FORD

FOCUS (cont)

12-13	Izquierdo	G52422	G511002
	Derecho	G52423	G511002
07-11	Modelo Europa Izquierdo	G52887	142930 ⁵³	G64182
	Modelo Europa Derecho	G52888	142930 ⁵³	G64182
06-11	Todos	142930 ⁵³
	Exc. Modelo Europa Izquierdo	G56836	142930 ⁵³
	Exc. Modelo Europa Derecho	G56837	142930 ⁵³
	Exc. Wagon y Europa Model	142930 ⁵³	I	81935 ³⁷	142992 ⁵³
	Exc. Wagon y Modelo Europa	142930 ⁵³	O	69464 ³⁷
06-07	Wagon	142930 ⁵³	O	69465
00-05	Izquierdo	G56516	142930 ⁵³
	Derecho	G56517	142930 ⁵³
	Exc. Wagon y Europa Model	I	81935 ³⁷	142992 ⁵³
	Exc. Wagon y Modelo Europa	O	69464 ³⁷
	Wagon	O	69465

FOCUS READYMOUNTS

		Delantero		Trasero	
06-11	Izquierdo Exc. Modelo Europa	G57081 ⁴⁰		
	Derecho Exc. Modelo Europa	G57082 ⁴⁰		
00-05	Izquierdo Exc. Modelo Europa	G57063 ⁴⁰		
	Derecho Exc. Modelo Europa	G57064 ⁴⁰		

FORD

49	Todos	I	82026	O	82060
----	-------	---	------	-------	------	------	------	---	------	-------	------	------	------

FORD 300

63	Todos	I	82099	O	82076
----	-------	---	------	-------	------	------	------	---	------	-------	------	------	------

FREESTAR

04-07	Todos	I	G56655	143246 ⁵³	O	G63873
-------	-------	---	--------	------	------	----------------------	------	---	--------	------	------	------	------

FREESTYLE

05-07	Izquierdo	I	G52110	143341 ⁵³
	Derecho	I	G52111	143341 ⁵³
	AWD	I	G51857
	FWD, Izquierdo	I	G51889
	FWD, Derecho	I	G51890



37 Reutilice o reemplace el tope de rebote del Equipo Original. No esta incluido con el amortiguador. Utilice el kit de montaje 142992 si los accesorios para montaje superior necesitan reemplazarse.

53 Montaje de Strut. Es probable reutilizar algunas partes del E.O.

40 Strut ReadyMount. Ensamble Completo

Texto en Negritas - Número de Parte Nuevo / Futuro





AMORTIGUADORES Y STRUTS

Año	Notas de Aplicación	Front					Rear				
			Ultra	ProGuard\ Guardian	LTV\ Max Control	Protector de Strut\ Bases de Strut	HiJacker\ Soporte\ Hidráulico		Ultra	ProGuard\ Guardian	LTV\ Max Control

FORD

FORD









FUSION

10-12	Izquierdo		G51896	143392 ⁵³
	Derecho		G51897	143392 ⁵³
	FWD		69591
06-09	Todos		G51859	143392 ⁵³
	FWD		G51859	143392 ⁵³	69591



FUSION READYMOUNTS

							Delantero		Trasero	
06-09	Todos						G57148 ⁴⁰		



GALAXIE

75-76	Todos		69675	81446		69606	81495
65-67	Todos		69675 ⁵	81446	34073 ⁸		69606	81495	43140 ⁹ 49205 ⁷
60-64	Todos		82099		82076
59	Todos		82099	





GALAXIE 500

68-74	Todos		69675 ⁵	81446	34073 ⁸		69606	81495	43140 ⁹ 49205 ⁷
-------	-------	--	--------------------	-------	------	------	--------------------	--	-------	-------	------	------	--





GHIA

84-94	Todos		G55714	81446	34073		G55733	81495	49205
-------	-------	---	--------	-------	------	------	-------	---	--------	-------	------	------	-------



GRANADA

81-82	Todos		G56504 ⁹	142197 ⁵³		69633	81460	43143 ⁹ 49199 ⁷
75-80	Todos		81491		82130













GRAND MARQUIS

01-02	Todos		69675 ⁵	81446	34073 ⁸		69606	81495	43140 ⁹ 49205 ⁷
95-00	Todos		81446		69606	81495

KA

01-08	Todos		G56748		G56712
-------	-------	---	--------	------	------	------	------	---	--------	------	------	------	------

LOBO PICK UP

14-15	RWD		G511102		G64157
15	4WD		G511103	
14	4WD		G511103		696079
10-13	4WD		G511103		696079
	RWD		G511102	
09	4WD		G51864		696079

5 Use el kit 140719 para reemplazar partes del EO de montaje inferior cuando los pernos se rompan o los tornillos autoroscantes no se puedan utilizar más.

8 Paquetes en pares

40 Strut ReadyMount. Ensamble Completo

Texto en Negritas - Número de Parte Nuevo / Futuro

7 Paquetes en pares; kit de mangueras de aire incluido

9 Vea Ref.D para los procedimientos de reemplazo de una Susp. Elect. Ajust. con un producto no ajust.

53 Montaje de Strut. Es probable reutilizar algunas partes del E.O.

AMORTIGUADORES Y STRUTS

Año	Notas de Aplicación	Front					Rear				
		Ultra	ProGuard\ Guardian	LTV\ Max Control	Protector de Strut\ Bases de Strut	HiJacker\ Soporte\ Hidráulico	Ultra	ProGuard\ Guardian	LTV\ Max Control	Protector de Strut\ Bases de Strut	HiJacker\ Soporte\ Hidráulico

FORD

FORD

LOBO PICK UP (cont)

09	RWD	G51865
05-08	Todos	143248
	4WD	143248	43184
	4WD; Exc. Heritage Series	G51704	143248	G63867
	RWD	143248	43183
	RWD Exc. Lightning Package	G51703	143248	G63870
04	Todos	143248	61612
	4WD	143248	61612	43184
	4WD Exc. 7700 GVW	77716	143248	61612	77715
	4WD; Exc. Heritage Series	G51704	143248	G63867	61612
	4WD; Exc. PBV 7700#	81914	58716	143248	81913 61612	58715
	Exc Lightning Model, RWD	G63714	143248	61612
	RWD	81912	143248	61638 61612	58778	43183
	RWD Exc. Lightning & 7700 GVW	G63714	61611	77714	143248	G63778	81892 61612	77778	49237
	RWD Exc. Lightning Package	G51703	143248	G63870	61612
02-03	4.6L 8Cyl (281) 4WD; FI	G63716
00-03	4.6L 8Cyl (281) 4WD; 4BBL	61614
99-03	5.4L 8Cyl (330) MFI	61614
	Exc Lightning Model, RWD	G63714
98-03	4WD	61613 81914	58716	58715
	4WD; Exc. PBV 7700#	61612 81913
97-03	4WD Exc. 7700 GVW	77716	G63715	77715
	RWD	81912	61638	58778
	RWD Exc. Lightning & 7700 GVW	G63714	61611	77714	G63778	81892	77778	49237
00-01	4.6L 8Cyl (281) 4WD; DOHC; MFI	G63716
98-99	4.6L 8Cyl (281) 4WD; 4BBL	G63716	61614
97	4.6L 8Cyl (281) 4WD; 4BBL	61614
	4WD	61613 81914	58716	61612	58715
	4WD; Exc. PBV 7700#	81913





LOBO PICK UP ESTABILIZADORES DE DIRECCIÓN

		Delantero	Trasero
97-04	Coil Spring Susp.	6860SE
97-03	4WD	6861SE

LOBO PICK UP READYMOUNTS

		Delantero	Trasero
09-13	Extended Cab Pickup; Exc. Suspensión Deportiva	G57103
	RWD; Crew Cab Pickup	G57132
	RWD; Extended Cab Pickup	G57132
04-08	4WD	G57020
	RWD	G57021









AMORTIGUADORES Y STRUTS

Año	Notas de Aplicación										
			Ultra	ProGuard\ Guardian	LTV\ Max Control	Protector de Strut\ Bases de Strut	HiJacker\ Soporte\ Hidráulico		Ultra	ProGuard\ Guardian	LTV\ Max Control



FORD

FORD



LTD / COUNTRY SEDAN / COUNTRY SQUIRE / CROWN VICTORIA

87-91	Todos		69675 ⁵	81446	34073 ⁸		69606	81495	43140 ⁹ 49205 ⁷
85-86	Modelos Policía y Taxi		G56504 ⁹	81446	142197 ⁵³		69633	81460	43143 ⁹ 49199 ⁷
83-86	Todos		G56504 ⁹	142197 ⁵³		69633	81460	43143 ⁹ 49199 ⁷
67-82	Todos		69675 ⁵	81446	34073 ⁸		69606	81495	43140 ⁹ 49205 ⁷



LTD II

77-79	Todos		69675 ⁵	81446	34073 ⁸		69606	81495	43140 ⁹ 49205 ⁷
-------	-------	---	--------------------	-------	------	------	--------------------	---	-------	-------	------	------	--



MAINLINE

52-56	Todos		82026		81270	49105 ⁷
-------	-------	---	------	-------	------	------	------	---	------	-------	------	------	--------------------

MAVERICK

70-77	Todos		81076		82130
-------	-------	---	------	-------	------	------	------	---	------	-------	------	------	------





























MONDEO

01-07	Todos		G56692		G56693
-------	-------	---	--------	------	------	------	------	---	--------	------	------	------	------

MOTORHOME CHASSIS / F53 ESTABILIZADORES DE DIRECCIÓN

								Delantero	Trasero				
89-91	Estabilizador de Dirección Sistema Sencillo Motorhome								6802SE ⁸⁴			

MUSTANG / MUSTANG II

11-14	Todos		G52406	
	Convertible		G52406		69593
	Coupe		G52406		69592
05-10	Todos		G56817	143341 ⁵³	
	Convertible		G56817	143341 ⁵³		69593
	Coupe		G56817	143341 ⁵³		69592
03-04	Modelos SVT Cobra y SVT Cobra R		G56790	142197 ⁵³	
94-04	Solo Modelos Base, March y GT		G55681	142197 ⁵³		69898	81794	75898	49234 ⁷
83-04	Todos		142197 ⁵³	
94-01	Modelos SVT Cobra y SVT Cobra R		G56790	142197 ⁵³	
91-93	Exc. Modelos GT y SVO		142197 ⁵³		69633
87-93	Modelo GT 5.0L 8 Cyl (302)		G55551	142197 ⁵³		69755
	Modelo LX; 2.3L 4 Cyl		142197 ⁵³		81460
93	GT		142197 ⁵³		75755

5 Use el kit 140719 para reemplazar partes del EO de montaje inferior cuando los pernos se rompan o los tornillos autoroscantes no se puedan utilizar más.

8 Paquetes en pares

53 Montaje de Strut. Es probable reutilizar algunas partes del E.O.

7 Paquetes en pares; kit de mangueras de aire incluido

9 Vea Ref.D para los procedimientos de reemplazo de una Susp. Elect. Ajust. con un producto no ajust.

84 Amortiguador de repuesto para los vehículos con el kit de montaje aftermarket GRC

AMORTIGUADORES Y STRUTS

Año	Notas de Aplicación	Front					Rear				
		Ultra	ProGuard\ Guardian	LTV\ Max Control	Protector de Strut\ Bases de Strut	HiJacker\ Soporte\ Hidráulico	Ultra	ProGuard\ Guardian	LTV\ Max Control	Protector de Strut\ Bases de Strut	HiJacker\ Soporte\ Hidráulico

FORD

FORD

MUSTANG / MUSTANG II (cont)

93	LX	G56504 ⁹	142197 ⁵³	75755	43143 ⁸ 49199 ⁷
	Modelo LX; 5.0l 8 Cyl	142197 ⁵³	81674
91-92	LX	G56504 ⁹	142197 ⁵³	43143 ⁸ 49199 ⁷
	5.0l 8 Cyl	142197 ⁵³	81674
87-92	5.0l 8 Cyl	142197 ⁵³	81674
	Modelos LX y GT 5.0L 8 Cyl (302)	142197 ⁵³	75755
90	LX	G56504 ⁹	142197 ⁵³		69633	43143 ⁸ 49199 ⁷
87-89	Exc. Modelos GT y SVO	142197 ⁵³		69633
	LX	G56504 ⁹	142197 ⁵³	43143 ⁸ 49199 ⁷
85-86	Exc. Modelos GT y SVO	142197 ⁵³		69633	81460	43143 ⁸
84-86	GT, SVO	142197 ⁵³		69755	81674	75755
	LX Exc. 5.0L	142197 ⁵³	49199 49199 ⁷
	Modelo GT 5.0L 8 Cyl (302)	G55551	142197 ⁵³
	Modelo LX; 2.3L y 5.0L	G56504 ⁹	142197 ⁵³
83-84	Exc. Modelos GT y SVO	142197 ⁵³		69633	81460	43143 ⁸ 49199 ⁷
83	5.0L 8 Cyl y 2.3L 4 Cyl	G56504 ⁹	142197 ⁵³
	GT y SVO Models	142197 ⁵³		69755	81674	75755
82	Todos	G56504 ⁹	142197 ⁵³
	Exc. Modelos Base y GT	G56504 ⁹	142197 ⁵³		69633	81460	43143 ⁸ 49199 ⁷
	GT y SVO Models	G56504 ⁹	142197 ⁵³		69755	81674	75755
79-81	Todos	G56504 ⁹		69633	81460	43143 ⁸ 49199 ⁷
74-78	5L 8Cyl (302) MFI	82128	82002
78	Todos	82002
74-77	Todos	82128	82002
	5.8L 8Cyl (351) TBI	82128	82002
71-73	Todos	81491	81270	49105 ⁷
73	5L 8Cyl (302) MFI	81491	81270	49105 ⁷
67-70	Todos	81076	81270	49105 ⁷
65-66	Todos	82104	81270	49105 ⁷

MUSTANG / MUSTANG II ESTABILIZADORES DE DIRECCIÓN

		Delantero	Trasero
84-04	Todos	14039

7 Paquetes en pares; kit de mangueras de aire incluido

8 Paquetes en pares

9 Vea Ref.D para los procedimientos de reemplazo de una Susp. Elect. Ajust. con un producto no ajust.

53 Montaje de Strut. Es probable reutilizar algunas partes del E.O.

AMORTIGUADORES Y STRUTS

Año	Notas de Aplicación	Front					Rear				
		Ultra	ProGuard\ Guardian	LTV\ Max Control	Protector de Strut\ Bases de Strut	HiJacker\ Soporte\ Hidráulico	Ultra	ProGuard\ Guardian	LTV\ Max Control	Protector de Strut\ Bases de Strut	HiJacker\ Soporte\ Hidráulico

FORD

FORD

P350 MICROBUS

86-97	5.8L 8Cyl (351) TBI	I O	G63414	61520 81490	42967	O O	81710
89-91	5L 8Cyl (302) MFI	I O	G63414	61520 81490	42967	O O	81710

PARK LANE WAGON

56	Todos	I I	82026	I I	81270
----	-------	--------	------	-------	------	------	------	--------	------	-------	------	------	------

PICKUP 1/2 TON, F SUPERDUTY

93-97	Fab. desde 2/93	O O	G63692	O O	G63409	61554 81710	58409 77409 ⁶
90-97	Todos	O O	O O	G63409	61554 81710	58409 77409 ⁶
90-93	Fab. hasta 2/93	O O	G63617	O O	G63409	61554 81710	58409 77409 ⁶

PICKUP 1/2 TON, F SUPERDUTY ESTABILIZADORES DE DIRECCIÓN

		Delantero		Trasero	
93-97	Con Amortiguador de EO	6857SE ⁸²		
90-92	Todos	6802SE ⁸⁴		

PICKUP 1/2 TON, F-100

80-83	RWD	I O	G63414	61520 81490	58414 77414	34057 ⁸	O O	G63409	61554 81710	58409 77409	43142 ⁸ 49197 ⁷
77-79	Kit de Levantamiento de 3-4" Exc. Suspensión Quad	I O	G63445 ⁵⁰	O O
	4WD; Kit de Levantamiento de 3-4" Exc. Suspensión Quad	I O	I O	G63447 ⁵⁰
76-79	Exc. Kit de Levantamiento	I O	G63386	O O
	RWD	I O	61521 ⁶ 81394	58386	34058 ⁸	I O	G63350	61518 81242	58350	43099 ⁸ 49173 ⁷
77-78	4.7L 8Cyl (289) DOHC; FI	O O	82033	O O	G63377	61519 81484
76	4.7L 8Cyl (289) DOHC; FI	O O	O O	G63377	61519 81484
	4WD; Exc. Kit de Levantamiento	O O	82033	I O	G63387	81285	49178 ⁷
	4WD; Kit de Levantamiento de 3 1/2-4"	I O	I O	G63447 ⁵⁰
75	Todos	I O	G63386	O O
	4.7L 8Cyl (289) DOHC; FI	I O	G63386	O O	G63377	61519 81484
	4WD; Exc. Kit de Levantamiento	I O	G63386	82033	I O	G63387	81285	49178 ⁷
	4WD; Kit de Levantamiento de 3 1/2-4"	I O	G63386	I O	G63447 ⁵⁰
	RWD	I O	G63386	61521 81394	58386	34058 ⁸	I O	G63350	61518 81242	58350	43099 ⁸ 49173 ⁷
73-74	RWD	I O	34058	O O
70-74	Exc. Kit de Levantamiento	I O	I O	49178 ⁷
69-74	4.7L 8Cyl (289) DOHC; FI	I O	G63386	82033	O O	G63377	61519 81484
69-71	4.7L 8Cyl (289) DOHC; EFI	O O	O O	G63377	61519 81484
67-68	4.7L 8Cyl (289) DIESEL	I O	G63386	O O	G63377	61519 81484
	4.7L 8Cyl (289) DOHC; FI	O O	82033	O O	G63377	61519 81484
66	4.7L 8Cyl (289) AWD; DOHC; FI	I O	G63386	O O	G63377	61519
	4.7L 8Cyl (289) AWD; DOHC; SFI	O O	O O	81484
	4.7L 8Cyl (289) AWD; SOHC; MFI	O O	O O	61519

6 Se recomienda que cuando se reemplacen amortiguadores "quad", los 4 sean de la misma serie.

8 Paquetes en pares

82 Use kit si está señalado. Vea Ref. C para Botas.

7 Paquetes en pares; kit de mangueras de aire incluido

50 Para proteger la barra del pistón, se recomienda utilizar el kit Bellows No.141242.

84 Amortiguador de repuesto para los vehículos con el kit de montaje aftermarket

GRC

AMORTIGUADORES Y STRUTS

Año	Notas de Aplicación	From					Rear				
		Ultra	ProGuard\ Guardian	LTV\ Max Control	Protector de Strut\ Bases de Strut	HiJacker\ Soporte\ Hidráulico	Ultra	ProGuard\ Guardian	LTV\ Max Control	Protector de Strut\ Bases de Strut	HiJacker\ Soporte\ Hidráulico

FORD

FORD

PICKUP 1/2 TON, F-100 (cont)

66	4.7L 8Cyl (289) AWD; Turbocharged; DIESEL	○	G63377	
	4.7L 8Cyl (289) AWD; Turbocharged; DOHC	○	81484	
	4.7L 8Cyl (289) DOHC; FI	○	82033	○	G63377	81484
65	4.7L 8Cyl (289) 4WD; TBI	○	G63386	○	G63377	61519
	4.7L 8Cyl (289) 4WD; Turbocharged; DIESEL	○	G63377	61519
	4.7L 8Cyl (289) AWD; DOHC	○	81484
	4.7L 8Cyl (289) DOHC; FI	○	G63405
	4WD 4.7L 8Cyl (289) DOHC; FI	○	G63187
61-64	Todos	○	82038
53	Exc. Heavy Duty	○	81676

PICKUP 1/2 TON, F-100 ESTABILIZADORES DE DIRECCIÓN

		Delantero	Trasero
80-83	RWD, Estabilizador de Dirección Sistema Sencillo	6802SE ⁸⁴
78-79	Estabilizador de Dirección Sistema Dual; Exc. Barra Estabilizadora	6802SE ⁸⁴
75-79	Estabilizador de Dirección Sistema Sencillo 4WD	6803SE ⁸⁴
	RWD, Estabilizador de Dirección Sistema Sencillo c/ Eje de Doble Viga en I	6802SE ⁸⁴
79	Sistema Sencillo 4WD	14016
75-78	4WD	14016
77	4WD; Estabilizador de Dirección Sistema Dual; Exc. Barra Estabilizadora	6802SE ⁸⁴
75-76	4WD, Estabilizador de Dirección Sistema Dual; Exc. Barra Estabilizadora	6802SE ⁸⁴

PICKUP 1/2 TON, F-150





14-15	RWD	↑	G64157
13-15	4WD	↓	G511103
	RWD	↓	G511102
14	4WD	○	G64079
13	4WD	↓	G51864	○	G64079
	RWD	↓	G51865	↑	G64157
11-12	RWD	↓	G51865	143424 ⁵³	↑	G64157
10-12	Todos	↓	143424 ⁵³
	4WD	↓	G51864	143424 ⁵³	○	G64079
	4WD	↓	G511103	143424 ⁵³
	RWD	↓	G511102	143424 ⁵³
10	RWD	↓	G51865	143424 ⁵³	○	G63867
09	4WD	↓	G51864	○	G64079
	RWD	↓	G51865	143376	○	G63867
05-08	RWD	↓	143248 ⁵³	↑	43183

53 Montaje de Strut. Es probable reutilizar algunas partes del E.O.

84 Amortiguador de repuesto para los vehículos con el kit de montaje aftermarket GRC

Texto en Negritas - Número de Parte Nuevo / Futuro















































AMORTIGUADORES Y STRUTS

Año	Notas de Aplicación										
			Ultra	ProGuard\ Guardian	LTV\ Max Control	Protector de Strut\ Bases de Strut	HiJacker\ Soporte\ Hidráulico		Ultra	ProGuard\ Guardian	LTV\ Max Control

FORD

FORD

PICKUP 1/2 TON, F-150 (cont)

04-08	Todos		143248 ⁵³	
	4WD		G51704	143248 ⁵³		G63867	43184
	RWD; Exc Lightning Model		G51703	143248 ⁵³		G63870
04	4WD, Exc. PBV 7700#		G63716	61613 81914	58716 77716	143248 ⁵³		G63715	61612 81913	58715 77715
	RWD		G63714	143248 ⁵³		43183
	RWD; Modelo Heritage		61611 81912	58714 77714	143248 ⁵³		G63778	61638 81892	58778 77778	49237 ⁷
99-03	RWD		G63714	61611 81912	58714 77714
	RWD; Exc Lightning Model			G63778	61638 81892	58778 77778	49237 ⁷
97-03	4WD		G63716	61613 81914	58716 77716
	4WD, Exc. PBV 7700#			G63715	61612 81913	58715 77715
98	RWD		61611 81912	58714 77714
	RWD; Exc Lightning Model		G63714		G63778	61638 81892	58778 77778	49237 ⁷
97	4.9L FI		42967
	RWD		G63714	61611 81912	58714 77714
	RWD; Exc Lightning Model			G63778	61638 81892	58778 77778	49237 ⁷
85-96	RWD		G63414	61520 ⁶ 81490	58414 ⁶ 77414 ⁶	34057 ⁸		G63406	61547 81082	58406 77406	43167 ⁸
84-96	3.8L FI		42967
80-96	4WD, Con o sin Suspensión Quad detrás del Eje Delantero; Exc. Kit de Levantamiento		G63414 ⁶	61520 ⁶ 81490	58414 ⁶ 77414 ⁶	34057 ⁸
	4WD, Exc. Kit de Levantamiento			G63461	61530 81510	58461 77461	49217 ⁷
	4WD, Suspensión Quad adelante del Eje Delantero; Exc. Kit de Levantamiento		G63410 ⁶	61546 ⁶	77410 ⁶
87-90	5L FI		42967
84-86	3.8L MFI			42958
80-86	Kit de Levantamiento de 3-4"		G63445 ⁵⁰		G63439 ⁵⁰
	4WD, Suspensión Quad c/ Kit de Levantamiento de 3-4" adelante del Eje Delantero		G63446 ⁶
86	5L FI		42967		42958
80-84	RWD		G63414	61520 ⁶ 81490	58414 ⁶ 77414 ⁶	34057 ⁸		G63409	61554 81710	58409 77409 ⁶	43142 ⁸ 49197 ⁷
78-79	4WD, Detrás del Eje Delantero		G63396
	4WD, Extended Cab Pickup Exc. Kit de Levantamiento		G63398
	4WD; Suspensión Quad Amortiguador Largo; Exc. Ranger XLT Model y Kit de Levantamiento		G63511 ⁶	61551 ⁶
77-79	4WD, Cab & Chassis Kit de Levantamiento de 3-4" Exc. Suspensión Quad		G63445 ⁵⁰		G63447 ⁵⁰

6 Se recomienda que cuando se reemplacen amortiguadores "quad", los 4 sean de la misma serie.

8 Paquetes en pares

53 Montaje de Strut. Es probable reutilizar algunas partes del E.O.

7 Paquetes en pares; kit de mangueras de aire incluido

50 Para proteger la barra del pistón, se recomienda utilizar el kit Bellows No.141242.

AMORTIGUADORES Y STRUTS

Año	Notas de Aplicación	Front					Rear				
		Ultra	ProGuard\ Guardian	LTV\ Max Control	Protector de Strut\ Bases de Strut	HiJacker\ Soporte\ Hidráulico	Ultra	ProGuard\ Guardian	LTV\ Max Control	Protector de Strut\ Bases de Strut	HiJacker\ Soporte\ Hidráulico

FORD

FORD

PICKUP 1/2 TON, F-150 (cont)

77-79	4WD, Standard Cab Pickup Kit de Levantamiento de 3-4" Exc. Suspensión Quad	○	G63445 ⁵⁰	○	G63447 ⁵⁰
	4WD; Exc. Kit de Levantamiento		○	G63387	61647 81285	49178 ⁷
75-79	RWD	○	G63386	61521 ⁶ 81394	58386	34058 ⁸	○	G63350	61518 81242	58350	49173 ⁷
	RWD, Standard Cab Pickup		○	43099 ⁸
72-79	desde 2a. Serie 72	↓	70169	↓
79	4.7L DOHC, FI		↓	42959
77	4WD	○	G63396	○
75-76	4WD; Exc. Kit de Levantamiento	○	82033	○	G63387	61647 81285	49178 ⁷
	4WD; Kit de Levantamiento; Exc. Extended Cab		○	G63447 ⁵⁰

PICKUP 1/2 TON, F-150 ESTABILIZADORES DE DIRECCIÓN

		Delantero	Trasero
97-03	4WD	6861SE ⁸²
	RWD, Coil(FrontSpringType)	6860SE ⁸²
94-96	4WD, Estabilizador de Dirección Sistema Sencillo c/ Vigas Dobles de Tracción	6802SE ⁸⁴
90-93	Estabilizador de Dirección Sistema Sencillo	6802SE ⁸⁴
80-89	Todos	6802SE ⁸⁴
77-79	Estabilizador de Dirección Sistema Dual; Exc. Barra Estabilizadora	6802SE ⁸⁴
76-79	4WD	14016
	4WD, Estabilizador de Dirección Sistema Sencillo	6803SE ⁸⁴
75-76	RWD	6802SE ⁸⁴
75	4WD	14016

PICKUP 1/2 TON, F-150 READYMOUNTS

		Delantero	Trasero
09-13	4WD, Extended Cab Pickup Exc. Suspensión Deportiva	G57103
	RWD; Exc. Standard Cab	G57132 ⁴⁰
04-08	4WD	G57020 ⁴⁰
	RWD	G57021 ⁴⁰

PICKUP 3/4 TON, F-250 / SUPERDUTY

12-16	RWD, w/Offroad Package	○	○	61682
16	4WD		○	61682	77952
14-15	4WD	○	○	G63888	61682	77952
	RWD		○	G64010	61713
11-15	RWD, Exc. Offroad Package	○	G63622	○
13	4WD	○	G63886	○	G63888	61682	77952
	RWD	○	G63622	○	G64010	61713
05-12	4WD	○	G63886	61680	77951	○	G63888	61682	77952
	RWD	○	G63622	58807 77807	○	G64010	61713
00-04	Todos	↓	61732	↓

6 Se recomienda que cuando se reemplacen amortiguadores "quad", los 4 sean de la misma serie.

8 Paquetes en pares

50 Para proteger la barra del pistón, se recomienda utilizar el kit Bellows No.141242.

84 Amortiguador de repuesto para los vehículos con el kit de montaje aftermarket

GRC



Texto en Negritas - Número de Parte Nuevo / Futuro

7 Paquetes en pares; kit de mangueras de aire incluido

40 Strut ReadyMount. Ensamble Completo

82 Use kit si está señalado. Vea Ref. C para Botas.



































































AMORTIGUADORES Y STRUTS

Año	Notas de Aplicación	Front					Rear				
			Ultra	ProGuard/ Guardian	LTV/ Max Control	Protector de Strut/ Bases de Strut	HiJacker/ Soporte/ Hidráulico		Ultra	ProGuard/ Guardian	LTV/ Max Control

FORD

FORD

PICKUP 3/4 TON, F-250 / SUPERDUTY (cont)

00-04	4WD		G63809	61655 61732	58809 77809		G63810	61656	58810 77810
	RWD		G63622	61732	58807 77807		G63808	61654	58808 77808
01	4WD 4.6L 8Cyl (281) 2BBL		81821 61732	
97-99	4WD, Hasta PBV 8500#, Exc. Superduty		G63716	61613 81914	58716 77716		G63715	61612 81913	58715 77715
	RWD, Hasta PBV 8500#		G63714	61611 81912	58714 77714		G63778	61638 81892	58778 77778	49237 ⁷
99	4WD		G63809	61655	58809 77809		G63810	61656	58810 77810
	RWD		G63622	58807 77807		G63808	61654	58808 77808
98	4WD, PBV arriba de 8500#		G63455	77455	
97	4WD, PBV arriba de 8500#		G63455	61614 81821	58455 77455		G63461	61530 81510	58461 77461	49241 ⁷
	RWD, PBV arriba de 8500#		G63414	61520 ⁶ 81490	58414 77414 ⁶		G63406	61547 81082	58406 77406	43167 ⁸
87-96	4WD		G63455	61614 81821	58455 77455		G63461	61530 81510	58461 77461	49241 ⁷
80-96	RWD		G63414	61520 ⁶ 81490	58414 ⁶ 77414 ⁶		G63406	61547 81082	58406 77406	43167 ⁸
96	RWD, Hasta PBV 8500#		61611	58714 77714	
86	4WD			G63461	61530 81510	58461 77461	49217 ⁷
	4WD, Montaje Inferior Delantero Tipo Abrazadera Exc. Doble Rodado o Kit de Levantamiento		G63416	
83-85	4WD, Montaje Inferior Delantero Tipo Abrazadera Exc. Doble Rodado o Kit de Levantamiento		G63416		G63461	61530 81510	58461 77461	49217 ⁷
80-82	4WD, Extended Cab Pickup		G63416	
	4WD, Standard Cab Pickup		G63410	
82	4WD		61546 ⁶	77410 ⁶	
	4WD, Montaje Inferior Delantero Tipo Abrazadera Exc. Doble Rodado o Kit de Levantamiento			G63461	61530 81510	58461 77461	49217 ⁷
80-81	4WD		61546 ⁶	77410 ⁶		G63461	61530 81510	58461 77461	49217 ⁷
77-79	4WD, Cab & Chassis Aplica para toda la serie No. Y20001		G63398		G63387	81285	49178 ⁷
	4WD, Standard Cab Pickup Aplica para toda la serie No. Y20001		G63398		G63387	81285	49178 ⁷
	4WD; Standard Cab, Cab y Chassis; Todos desde Serie No. Y20001			49178 ⁷
75-79	RWD		G63386	61521 ⁶ 81394	58386	34058 ⁸		77377
	RWD, Cab & Chassis			G63350	61518 81242	43058 ⁸ 49127 ⁷
	RWD, Extended Cab Pickup			G63377	61519 81484	58377	43058 ⁸ 49127 ⁷
	RWD, Standard Cab Pickup			G63350	61518 81242	43099 ⁸ 49173 ⁷
	RWD; Exc. Extended y Crew Cab			58350
72-79	desde 2a. Serie 72		70169	
75-77	4WD; Toda la serie No. Y20000		G63187	82034		82147
70-74	Standard Cab Pickup RWD			58350
61-62	RWD		82038	

6 Se recomienda que cuando se reemplacen amortiguadores "quad", los 4 sean de la misma serie.

7 Paquetes en pares; kit de mangueras de aire incluido

8 Paquetes en pares

AMORTIGUADORES Y STRUTS

Año	Notas de Aplicación	Front					Rear				
		Ultra	ProGuard\ Guardian	LTV\ Max Control	Protector de Strut\ Bases de Strut	HiJacker\ Soporte\ Hidráulico	Ultra	ProGuard\ Guardian	LTV\ Max Control	Protector de Strut\ Bases de Strut	HiJacker\ Soporte\ Hidráulico

FORD

FORD

PICKUP 3/4 TON, F-250 / SUPERDUTY ESTABILIZADORES DE DIRECCIÓN

		Delantero	Trasero
08-10	4WD	14072
05-07	4WD, Exc. Estabilizador de Dirección de EO	6856SE ⁸²
99-06	RWD	6828SE ⁸⁰
99-04	4WD, Exc. Unidad de EO	6850SE ⁸²
	4WD, Kit de Reemplazo	6855SE ⁸²
99-03	4WD, Con Amortiguador de EO	6854SE ⁸⁰
97-99	4WD, Barra de Torsion(FrontSpringType)	6861SE ⁸²
	RWD, Coil(FrontSpringType)	6860SE ⁸²
80-96	4WD, Estabilizador de Dirección Sistema Sencillo	6802SE ⁸⁴
77-79	4WD, Power Steering Estabilizador de Dirección Sistema Sencillo	6805SE ⁸⁰
75-79	RWD, Estabilizador de Dirección Sistema Sencillo	6802SE ⁸⁴
75-77	4WD, Manual Steering Estabilizador de Dirección Sistema Sencillo	6803SE ⁸⁴

PICKUP 1 TON, F-350 / SUPERDUTY

05-12	4WD	⊖ ⊙	G63886	61680	77951
	4WD; Rodado Sencillo; Exc. Cab y Chassis	⊖ ⊙
	RWD	⊖ ⊙	G63622	58807 77807
05-07	4WD; Doble Rodada Trasera; Exc. Cab y Chassis	⊖ ⊙
05-06	4WD, Cab & Chassis	⊖ ⊙
01-04	RWD	⊖ ⊙	G63622	61732	58807 77807
99-04	Todos	⊖ ⊙	61732
	4WD	⊖ ⊙	G63809	61655 61732	58809 77809
99-00	RWD	⊖ ⊙	G63622	81490 61732	58807 77807
	RWD 5.4L 8Cyl (330) MFI	⊖ ⊙	G63414	61520 61732
94-97	4WD 5L 8Cyl (302) FI	⊖ ⊙	G63455
86-97	4WD	⊖ ⊙	G63455	61614 81821	58455 77455	42952
	4WD, Doble Rodada Trasera	⊖ ⊙
	4WD, Exc. Doble Rodada Trasera	⊖ ⊙
80-97	Eje Trasero Doble Rodado	⊖ ⊙	70169
	RWD	⊖ ⊙	G63414	61520 ⁶ 81490	58414 ⁶ 77414 ⁶	42967
	RWD, Doble Rodada Trasera	⊖ ⊙
	RWD, Exc. Doble Rodada Trasera	⊖ ⊙	43167 ⁸
86-92	4WD 5L 8Cyl (302) FI	⊖ ⊙	G63455
86-90	4WD 5.8L 8Cyl (351) SOHC; TBI	⊖ ⊙	G63455
83-85	5L 8Cyl (302) FI	⊖ ⊙	G63410	61546	42952
82-85	4WD, Montaje Inferior Delantero Tipo Abrazadera Exc. Doble Rodado o Kit de Levantamiento	⊖ ⊙	G63416	49217 ⁷
81-82	5L 8Cyl (302) FI	⊖ ⊙	42952
80-81	4WD	⊖ ⊙	G63410	61546 ⁶	77410 ⁶	77461	49217 ⁷

6 Se recomienda que cuando se reemplacen amortiguadores "quad", los 4 sean de la misma serie.

8 Paquetes en pares



82 Use kit si está señalado. Vea Ref. C para Botas.

7 Paquetes en pares; kit de mangueras de aire incluido

80 No requiere soportes para el montaje, instalar sobre montajes de EO Vea Ref. C para Botas.

84 Amortiguador de repuesto para los vehículos con el kit de montaje aftermarket GRC































AMORTIGUADORES Y STRUTS

Año	Notas de Aplicación	Front					Rear				
			Ultra	ProGuard\ Guardian	LTV\ Max Control	Protector de Strut\ Bases de Strut	HiJacker\ Soporte\ Hidráulico		Ultra	ProGuard\ Guardian	LTV\ Max Control

FORD

FORD

PICKUP 1 TON, F-350 / SUPERDUTY (cont)

80-81	4WD, Doble Rodada Trasera		G63461	61530 81510	58461
80	5L 8Cyl (302) FI		61546	42952	
75-79	RWD		61521 ⁶ 81394	58386	34058 ⁸ 70169		70172
	RWD, Cab & Chassis		70169		43099 ⁸ 49173 ⁷ 70172
	RWD, Extended Cab Pickup		G63396	70169	G63350	61518	58350	43099 ⁸ 49173 ⁷ 70172
	RWD, Standard Cab Pickup		G63386	70169	G63377	61519 81484	58377 77377	43058 ⁸ 49127 ⁷ 70172
	RWD; Supercab		70169		81242	70172
67-79	Todos		70169		70172
	5L FI		42952 70169		70172
79	4WD		G63398	70169	G63387	61647 81285	49178 ⁷ 70172
78	4WD 5L 8Cyl (302) FI		G63455	70169	G63377	70172
	5L 8Cyl (302) FI		61614 81821	70169		61519 81484	70172
74-77	4.7L 8Cyl (289) DOHC; MFI		61614 81821	70169		61519 81484	70172
	4WD 4.7L 8Cyl (289) DOHC; MFI		G63455	70169	G63377	70172
67-77	4.7L DOHC, MFI		42952 70169		70172
77	4WD 5L 8Cyl (302) FI		G63455	70169		70172
	5L 8Cyl (302) FI		61614 81821	70169		70172
76	4WD 5L 8Cyl (302) FI		G63455	70169	G63377	70172
	5L 8Cyl (302) FI		61614 81821	70169		61519 81484	70172
74	4WD 5L 8Cyl (302) FI		G63455	70169	G63377	70172
	5L 8Cyl (302) FI		61614 81821	70169		61519 81484	70172
71-73	4.7L 8Cyl (289) DOHC; MFI		61614 81821	70169	G63377	61519 81484	70172
67-73	4WD 4.7L 8Cyl (289) DOHC; MFI		G63455	70169		70172
	4WD 5L 8Cyl (302) FI		G63455	70169		70172
	5L 8Cyl (302) FI		61614 81821	70169	G63377	61519 81484	70172
67-70	4.7L 8Cyl (289) DOHC; FI		70169	G63377	61519 81484	70172
70	4.7L 8Cyl (289) DOHC; MFI		61614 81821	70169		81484	70172
67-69	4.7L 8Cyl (289) DOHC; MFI		61614 81821	70169		70172
67	4WD 5.8L 8Cyl (352) SOHC; TBI		G63455	70169		70172
	5.8L 8Cyl (352) SOHC; MFI		70169	G63377	61519 81484	70172
	5.8L 8Cyl (352) SOHC; TBI		61614 81821	70169		70172

6 Se recomienda que cuando se reemplacen amortiguadores "quad", los 4 sean de la misma serie.

7 Paquetes en pares; kit de mangueras de aire incluido

8 Paquetes en pares

AMORTIGUADORES Y STRUTS

Año	Notas de Aplicación	From					Rear				
		Ultra	ProGuard\ Guardian	LTV\ Max Control	Protector de Strut\ Bases de Strut	HiJacker\ Soporte\ Hidráulico	Ultra	ProGuard\ Guardian	LTV\ Max Control	Protector de Strut\ Bases de Strut	HiJacker\ Soporte\ Hidráulico

FORD

FORD

PICKUP 1 TON, F-350 / SUPERDUTY (cont)

67	5.8L SOHC, TBI	○	42952 70169	↑	70172	
65-66	4.7L 8Cyl (289) DOHC; FI	○	○	G63405	
	4.7L 8Cyl (289) DOHC; MFI	○	61614 81821	○	81510	
	4.7L DOHC, MFI	○	42952	○	
	4WD 4.7L 8Cyl (289) DOHC; MFI	○	G63455	○	
	4WD 5.8L 8Cyl (352) TBI	○	G63455	○	
	4WD 5L 8Cyl (302) FI	○	G63455	○	
	5.8L TBI	○	42952	○	
	5L 8Cyl (302) FI	○	61614 81821	○	G63405	81510
	5L FI	○	42952	○	
66	5.8L 8Cyl (352) SOHC; MFI	○	○	G63405	
	5.8L 8Cyl (352) TBI	○	61614 81821	○	81510	
65	5.8L 8Cyl (352) SOHC; FI	○	○	G63405	
	5.8L 8Cyl (352) SOHC; VTEC	○	61614	○	
	5.8L 8Cyl (352) TBI	○	81821	○	81510	

PICKUP 1 TON, F-350 / SUPERDUTY ESTABILIZADORES DE DIRECCIÓN

		Delantero	Trasero
08-10	4WD	14072
99-06	RWD	6828SE ⁸⁰
99-04	4WD, Exc. Unidad de EO	6850SE ⁸²
	4WD, Kit de Reemplazo	6855SE ⁸²
99-03	4WD, Con Amortiguador de EO	6854SE ⁸⁰
95-97	4WD	6826SE ⁸⁰
92-96	RWD, Estabilizador de Dirección Sistema Dual	6802SE ⁸⁴
89-91	RWD, Estabilizador de Dirección Sistema Sencillo	6802SE ⁸⁴
82-88	Estabilizador de Dirección Sistema Sencillo, c/ Barra Estabilizadora	6802SE ⁸⁴
79-81	RWD, Estabilizador de Dirección Sistema Dual	6802SE ⁸⁴
79	4WD, Power Steering Estabilizador de Dirección Sistema Sencillo	6805SE ⁸⁰
75-78	Estabilizador de Dirección Sistema Dual	6802SE ⁸⁴
75-77	Manual Steering Estabilizador de Dirección Sistema Sencillo	6803SE ⁸⁴

PICKUP P100 ESTABILIZADORES DE DIRECCIÓN

		Delantero	Trasero
65-67	Estabilizador de Dirección Sistema Sencillo	6802SE ⁸⁴

PICKUP P350



76	Todos	○	61500	○
	Hasta PBV 8000#	○	G63405	61500	77405	○
	Hasta PBV 8000#	○	61500	43048	○
68-75	Todos	○	○	82123
	Hasta PBV 8000#	○	G63405	61500 81147	77405	○	82123
	Hasta PBV 8000#	○	43048	○	82123

PICKUP P350 ESTABILIZADORES DE DIRECCIÓN

		Delantero	Trasero
68-73	Estabilizador de Dirección Sistema Sencillo	6802SE ⁸⁴

80 No requiere soportes para el montaje, instalar sobre montajes de EO Vea Ref. C para Botas.
82 Use kit si está señalado. Vea Ref. C para Botas.
84 Amortiguador de repuesto para los vehículos con el kit de montaje aftermarket GRC

AMORTIGUADORES Y STRUTS

Año	Notas de Aplicación										
		Ultra	ProGuard\ Guardian	LTV\ Max Control	Protector de Strut\ Bases de Strut	HiJacker\ Soporte\ Hidráulico	Ultra	ProGuard\ Guardian	LTV\ Max Control	Protector de Strut\ Bases de Strut	HiJacker\ Soporte\ Hidráulico

FORD

FORD

PINTO (cont)

71-73	Sedan	82128	82004
-------	-------	-------	-------	-------	-------	-------	-------	-------	-------	-------	-------

PROBE

93-97	Izquierdo	G55671	142856 ⁵⁴	G55672
	Derecho	G55670	142856 ⁵⁴	G55672
91-92	Base, GL, GT, Automatic	G55600 ⁹	142562 ⁵⁸	G55601 ⁹	142196 ⁵³
89-92	Todos	G55600 ⁹	G55601 ⁹	142196 ⁵³
90	GL, GT, Automatic	G55600 ⁹	142562 ⁵⁸	G55601 ⁹	142196 ⁵³
89	GL, LX, Automatic	G55600 ⁹	142562 ⁵⁸	G55601 ⁹	142196 ⁵³

RANCH WAGON

65-74	Todos	69675 ⁵	81446 82126	34073 ⁸	69606	81495	43140 ⁶ 49205 ⁷
59-64	Todos	82099	82076
57-58	Todos	82099
52-56	Todos	82026	81270	49105 ⁷
50-51	Todos	82026	82060

RANCHERO

72-79	Todos	81446	34073 ⁸	69606	81495	43140 ⁶ 49205 ⁷
66-71	Todos	82126	69606	81495
60-65	Todos	82126	81270	49105 ⁷
59	Todos	82099	82076

RANGER

13-14	Todos	G64131⁴
12	Todos	G63678	77678	G63775	81918
	4WD	G63678	61623 81893	77678	G63775	61629 81918	77524
	RWD, Barra de Torsion	G63678	61623 81893	77678	G63775	61629 81918	77524
	RWD; Coil (FrontSpringType)	G63772	61626 81916	77772 77678	G63773	61627 81917	77525	43167 ⁸
06-11	4WD	G63678	61623 81893	77678	G63775	61629 81918	77524
	RWD, Barra de Torsion(FrontSpringType)	G63678	61623 81893	77678	G63775	61629 81918	77524
	RWD; Coil (FrontSpringType)	G63772	61626 81916	77772	G63773	61627 81917	77525	43167 ⁸
98-11	4WD	43184 43185	
06	RWD, Coil(FrontSpringType)	49223 ⁷	

4 Número de futuro, las cantidades disponibles Q4 2016.

7 Paquetes en pares; kit de mangueras de aire incluido

9 Vea Ref.D para los procedimientos de reemplazo de una Susp. Elect. Ajust. con un producto no ajust.

54 Kit con Montaje y Rodamiento. Es probable que reutilizar algunas partes del E.O.

5 Use el kit 140719 para reemplazar partes del EO de montaje inferior cuando los pernos se rompan o los tornillos autoroscantes no se puedan utilizar más.



8 Paquetes en pares

53 Montaje de Strut. Es probable reutilizar algunas partes del E.O.

58 El Kit de Montaje incluye: Rodamiento de Suspensión. Es probable reutilizar algunas partes del E.O.

Texto en Negritas - Número de Parte Nuevo / Futuro































AMORTIGUADORES Y STRUTS

Año	Notas de Aplicación	Front					Rear				
			Ultra	ProGuard\ Guardian	LTV\ Max Control	Protector de Strut\ Bases de Strut	HiJacker\ Soporte\ Hidráulico		Ultra	ProGuard\ Guardian	LTV\ Max Control

FORD

FORD







RANGER (cont)

01-05	Edge, 4WD, RWD		G63678	61623 81893	77678		G63775	61629 81918	77524
	Exc. Modelos Edge, EV, Splash y Deportivo			G63773	61627 81917	77525
	RWD, Suspensión con Resorte Delantero Exc. Modelos Sport, STX y Tremor con Barra de Torsion		G63772	61626 81916	77772						
98-05	RWD			43167 ⁸ 49223 ⁷
98-00	4WD		G63678	61623 81893	77678		G63775	61629 81918	77524
	Exc. Modelos Edge, EV, Splash y Deportivo		G63772	61626 81916	77772		G63773	61627 81917	77525
90-97	Todos		G63614	61561 81744	58929 77614
	4WD		G63614	61561 81744	58929 77614		G63524	61573 81905	77524
	4WD		G63614	61561 81744	58929 77614		43184 43185
	RWD		G63614	61561 81744	58929 77614		G63525	61559 81730	77525	43167 ⁸ 49223 ⁷
87-89	Exc. Opción High Ryder		G63414	61520 ⁶ 81490	77414 ⁶	34057 ⁸	
89	4WD			G63524
	4WD			61534 81540	43184 43185
	4WD, Fab. desde 2/89; Vehículos con perno de 12mm en montaje inferior trasero			81905	77524
	4WD, Opción High Ryder			61573
	RWD, Fab. desde 2/89; Vehículos con perno de 12mm en montaje inferior trasero			G63525	61559 81730	77525	49223 ⁷
	RWD, Fab. hasta 2/89; Vehículos con perno 10mm y 12mm en montaje inferior trasero			G63427	61533 81539	43165 ⁸ 49207 ⁷
87-88	4WD			G63420	61534 81540	43184 43185
	RWD			G63427	61533 81539	43165 ⁸ 49207 ⁷
83-86	Todos		G63414	61520 ⁶ 81490	77414 ⁶	34057 ⁸	
	4WD		G63414	61520 ⁶ 81490	77414 ⁶	34057 ⁸		G63420	61534 81540	43184 43185
	RWD		G63414	61520 ⁶ 81490	77414 ⁶	34057 ⁸		G63427	61533 81539	43165 ⁸ 49207 ⁷

RANGER ESTABILIZADORES DE DIRECCIÓN

		Delantero	Trasero
83-97	Estabilizador de Dirección Sistema Sencillo	6802SE ⁸⁴

SABLE

03-14	3L 6Cyl			81693
02-05	Izquierdo		G55978	143059
	Derecho		G55960	143059
	Wagon			69962	81927
96-05	Sedan			G55901	143057
02	3L 6Cyl			69962	81693
96-01	Izquierdo		G55978	143059

6 Se recomienda que cuando se reemplacen amortiguadores "quad", los 4 sean de la misma serie.

8 Paquetes en pares

7 Paquetes en pares; kit de mangueras de aire incluido

84 Amortiguador de repuesto para los vehículos con el kit de montaje aftermarket GRC

AMORTIGUADORES Y STRUTS

Año	Notas de Aplicación	Front					Rear				
		Ultra	ProGuard\ Guardian	LTV\ Max Control	Protector de Strut\ Bases de Strut	HiJacker\ Soporte\ Hidráulico	Ultra	ProGuard\ Guardian	LTV\ Max Control	Protector de Strut\ Bases de Strut	HiJacker\ Soporte\ Hidráulico

FORD

FORD

SABLE (cont)

96-01	Derecho	↓	G55960	143059
	Wagon	↓	69962	81927
	3L 6Cyl	↓	81693
94-95	3.8L	↓	G55616	69756	49216
	Sedan	↓	G55616	G55901	143057 49216
86-95	Todos	↓	G55616	49216
	Wagon	↓	G55616	69756	81693	...	49216

SKYLINER

59	Todos	↓	...	82099	82076
57-58	Todos	↓	...	82099
54-56	Todos	↓	...	82026	81270	...	49105 ⁷

STARLINER

60	Todos	↓	...	82099	82076
----	-------	---	-----	-------	-----	-----	-----	-----	-------	-----	-----

SUNLINER

60	Todos	↓	...	82099	82076
59	Todos	↓	...	82099
57-58	Todos	↓	...	82099	81270	...	49105 ⁷
52-56	Todos	↓	...	82026	81270	...	49105 ⁷

SUPER DELUXE

47-48	Amortiguadores de Acción Directa	↓	...	82007	82156
-------	----------------------------------	---	-----	-------	-----	-----	-----	-----	-------	-----	-----

TAURUS





10-14	Todos	↓	143476 ⁵³
	w/ Suspensión Code A y B	↓	70096	143476 ⁵³
10-12	Izquierdo w/ Suspensión Code A y B	↓	G52398	143476 ⁵³
	Derecho w/ Suspensión Code A y B	↓	G52399	143476 ⁵³
08-09	FWD, Izquierdo	↓	G52129	143407
	FWD, Derecho	↓	G52130	143407
07-09	FWD; Fab. hasta 06/07 Izquierdo	↓	G51875
	FWD; Fab. hasta 06/07 Derecho	↓	G51876
96-07	Izquierdo	↓	G55978
	Derecho	↓	G55960
	Sedan	↓	G55901
96-05	Wagon	↓	69962	81927

7 Paquetes en pares; kit de mangueras de aire incluido

53 Montaje de Strut. Es probable reutilizar algunas partes del E.O.

Texto en Negritas - Número de Parte Nuevo / Futuro









AMORTIGUADORES Y STRUTS

Año	Notas de Aplicación										
			Ultra	ProGuard\ Guardian	LTV\ Max Control	Protector de Strut\ Bases de Strut	HiJacker\ Soporte\ Hidráulico		Ultra	ProGuard\ Guardian	LTV\ Max Control

FORD

FORD











TAURUS (cont)

94-95	Sedan		G55616	142746 ⁶		G55901
86-95	Todos		G55616	142746 ⁶	
	Wagon		G55616	142746 ⁶		69756	81693	49216 ⁷
86-93	Sedan		G55616	142746 ⁶		G55518











TAURUS READYMOUNTS

				Delantero	Trasero
96-07	Izquierdo			G56934 ⁴⁰
	Derecho			G56937 ⁴⁰
	Sedan			G56936 ⁴⁰
94-95	Sedan			G56912 ⁴⁰	G56936 ⁴⁰
86-95	Todos			G56912 ⁴⁰
86-93	Sedan			G56912 ⁴⁰	G56913 ⁴⁰













TAURUS X

08-09	Izquierdo		G52400	143415	
	Derecho		G52401	143415	
	AWD			G51857
	FWD, Izquierdo			G51889
	FWD, Derecho			G51890

TEMPO

87-94	Todos		G55714	
	FWD		G55714		G55733
87-91	AWD		G55714		G55722
85-86	FWD, Fab. desde 3/85		G55714	
84-86	FWD			G55733

THUNDERBIRD

02-05	Todos		G51770	143242 ⁵³		G51771	143242 ⁵³
92-97	Exc. Suspensión Electrónica Ajustable		G55579	142222 ⁵³		69845	81795
89-91	Exc. Suspensión Electrónica Ajustable		G55579	142222 ⁵³		69820
87-88	Non-ABS			69709 ⁹	81461	49196 ⁷
	Non-ABS, Naturally Aspirated(Eng Asp)		G56504 ⁹	
80-86	Todos		G56503 ³⁹		69709 ⁹	81461	49196 ⁷

6 Se recomienda que cuando se reemplacen amortiguadores "quad", los 4 sean de la misma serie.

9 Vea Ref.D para los procedimientos de reemplazo de una Susp. Elect. Ajust. con un producto no ajust.

40 Strut ReadyMount. Ensamble Completo

Texto en Negritas - Número de Parte Nuevo / Futuro

7 Paquetes en pares; kit de mangueras de aire incluido

39 El strut de aire ajustable de EO puede reemplazarse con un strut convencional.

Sin embargo, el sistema de autonivelación debe desactivarse. Vea Ref. A.

53 Montaje de Strut. Es probable reutilizar algunas partes del E.O.

AMORTIGUADORES Y STRUTS

Año	Notas de Aplicación	Front					Rear				
		Ultra	ProGuard\ Guardian	LTV\ Max Control	Protector de Strut\ Bases de Strut	HiJacker\ Soporte\ Hidráulico	Ultra	ProGuard\ Guardian	LTV\ Max Control	Protector de Strut\ Bases de Strut	HiJacker\ Soporte\ Hidráulico

FORD

FORD

THUNDERBIRD (cont)

77-79	Todos	69675 ⁵	81446	34073 ⁸	69606	81495	43140 ⁶ 49205 ⁷
73-76	Todos	69675 ⁵	81446	34073 ⁸	82603
67-72	Todos	69675 ⁵	81446	34073 ⁸	69606	81495	43140 ⁶ 49205 ⁷
64-66	Todos	82617
59-60	Todos	82099
55-57	Todos	82026	81270	49105 ⁷

THUNDERBIRD ESTABILIZADORES DE DIRECCIÓN

		Delantero		Trasero	
84-88	Todos	14039		

THUNDERBIRD READYMOUNTS

		Delantero		Trasero	
89-97	Izquierdo Exc. Suspensión Electrónica Ajustable	G56976⁴⁰		
	Derecho Exc. Suspensión Electrónica Ajustable	G56977⁴⁰		

TOPAZ

86-94	RWD	G55714	G55733
-------	-----	--------	------	------	------	------	--------	------	------	------	------

TORINO

74-76	Wagon	69675 ⁵	81446	34073 ⁸	69606	81495	43140 ⁶ 49205 ⁷
72-76	Todos	69675 ⁵	81446	34073 ⁸	69606	43140 ⁶ 49205 ⁷
68-71	Todos	82126	69606	49105 ⁷
71	Wagon	82126	69606	81495	49105 ⁷
68-70	Exc. Wagon	82126	69606	81270	49105 ⁷

TRANSIT

07-13	Todos	G52220	G64063
-------	-------	--------	------	------	------	------	--------	------	------	------	------

TRANSIT CONNECT

10-13	Izquierdo	G52369	143564⁵³	G64114
	Derecho	G52370	143564⁵³	G64114

VAGONETA

96-97	Todos	G55597
-------	-------	------	------	------	------	------	--------	------	------	------	------

VAN 1/2 TON, ECONOLINE / CLUB WAGON

12-14	Todos	G63622	81744	G63623	61646 81828	58623 77623	49178 ⁷
10-11	Todos	G63622	61591 81744	58929 77608	G63623	61595 81828	58623 77623	49178 ⁷
08-09	Todos	G63622	61591 81744	58929 77608	G63623	61595	58624	49178 ⁷
92-07	Todos	G63929	61591 81744	58929 77608	G63624	61595 81833	58624	49178 ⁷
75-91	Todos	70170
	Todos	G63500	61553 81694	G63350	61518 81242	58350	43099 ⁶ 49173 ⁷ 70170

5 Use el kit 140719 para reemplazar partes del EO de montaje inferior cuando los pernos se rompan o los tornillos autoroscantes no se puedan utilizar más.

8 Paquetes en pares





53 Montaje de Strut. Es probable reutilizar algunas partes del E.O.

Texto en Negritas - Número de Parte Nuevo / Futuro

7 Paquetes en pares; kit de mangueras de aire incluido

40 Strut ReadyMount. Ensamble Completo





AMORTIGUADORES Y STRUTS

Año	Notas de Aplicación										
			Ultra	ProGuard\ Guardian	LTV\ Max Control	Protector de Strut\ Bases de Strut	HiJacker\ Soporte\ Hidráulico		Ultra	ProGuard\ Guardian	LTV\ Max Control

FORD

FORD













VAN 1/2 TON, ECONOLINE / CLUB WAGON (cont)

69-74	Todos		82012		G63377	61519 81484	77377	43058 ⁶ 49127 ⁷
68	A finales de 1968			82007

VAN 1/2 TON, ECONOLINE / CLUB WAGON ESTABILIZADORES DE DIRECCIÓN

		Delantero		Trasero	
95-01	Kit de Repuesto	6858SE		
69-74	Estabilizador de Dirección Sistema Sencillo c/ Eje de Doble Viga en I	6802SE ⁸⁴		



































VAN 3/4 TON, ECONOLINE / CLUB WAGON / SUPERDUTY

03-14	Todos		G63622	81744	58622 77614		G63623	61646 81828	58623 77623	49178 ⁷
92-02	Todos		G63622	61591 81744	58622 77614		G63623	61646 81828	58623 77623	49178 ⁷
85-91	Todos		70169	
	Todos		G63386	61521 ⁶ 81394	58386	34058 ⁸ 70169		G63387	61647 81285	49178 ⁷
75-84	Todos		G63386	61521 ⁶ 81394	58386	34058 ⁸		G63387	61647 81285	49178 ⁷
69-74	Todos		82012		G63377	61519 81484	77377	43058 ⁶ 49127 ⁷

VAN 3/4 TON, ECONOLINE / CLUB WAGON / SUPERDUTY ESTABILIZADORES DE DIRECCIÓN

		Delantero		Trasero	
95-01	Kit de Repuesto	6858SE		
74-79	QuadraVan Special	6803SE ⁸⁴		
69-74	Estabilizador de Dirección Sistema Sencillo c/ Eje de Doble Viga en I	6802SE ⁸⁴		

VAN 1 TON, ECONOLINE / CLUB WAGON / SUPERDUTY

12-14	Todos		G63622	81744	58622 77614		G63623	61646 81828	58623 77623	49178 ⁷
	Exc. Cutaway Chassis		G63622	81744	77614 58622		G63623	81828 61646	77623 58623	49178 ⁷
	Exc. Paquete de Ambulancia y Manejo		G63622	81744	77614 58622		G63623	61646 81828	58623 77623	49178 ⁷
08-11	Exc. Cutaway Chassis		G63622	61591 81744	58622 77614		G63623	61646 81828	58623 77623	49178 ⁷
	Exc. Paquete de Ambulancia y Manejo		G63622	61591 81744	58622 77614		G63623	61646 81828	58623 77623	49178 ⁷
11	Todos		G63622	61591 81744	58622 77614		G63623	61646 81828	58623 77623	49178 ⁷
10	Todos		G63622	61591 81744	58622 77614		G63623	61646 81828	58623	49178 ⁷
09	Todos		G63622	61591 81744	77614		49178 ⁷
08	Todos		G63622	61591 81744	77614		77623	49178 ⁷
	Conversión a Motorhome		G63622	61591 81744	58622 77614		58623 77623	49178 ⁷
	Cutaway Chassis		G63622	61591 81744	58622 77614		58623 77623	49178 ⁷
07	Todos		G63622	61591	77614		77623	49178 ⁷
	Conversión a Motorhome		G63622	61591	58622 77614		58623 77623	49178 ⁷
	Cutaway Chassis		G63622	61591	58622 77614		58623 77623	49178 ⁷
	Exc. Cutaway Chassis		G63622	81744 61591	58622 77614		G63623	61646 81828	58623 77623	49178 ⁷
	Exc. Paquete de Ambulancia y Manejo		G63622	81744 61591	58622 77614		G63623	61646 81828	58623 77623	49178 ⁷
04-06	Exc. Cutaway Chassis		G63622	61591 81744	58622 77614		G63623	61646 81828	58623 77623	49178 ⁷

6 Se recomienda que cuando se reemplacen amortiguadores "quad", los 4 sean de la misma serie.

8 Paquetes en pares

7 Paquetes en pares; kit de mangueras de aire incluido

84 Amortiguador de repuesto para los vehículos con el kit de montaje aftermarket GRC

AMORTIGUADORES Y STRUTS

Año	Notas de Aplicación	From					Rear				
		Ultra	ProGuard\ Guardian	LTV\ Max Control	Protector de Strut\ Bases de Strut	HiJacker\ Soporte\ Hidráulico	Ultra	ProGuard\ Guardian	LTV\ Max Control	Protector de Strut\ Bases de Strut	HiJacker\ Soporte\ Hidráulico

FORD

FORD

VAN 1 TON, ECONOLINE / CLUB WAGON / SUPERDUTY (cont)

04-06	Exc. Paquete de Ambulancia y Manejo	○	G63622	61591 81744	58622 77614	○	G63623	61646 81828	58623 77623	49178 ⁷
06	Todos	○	G63622	61591 81744	77614	○	49178 ⁷
04-05	Todos	○	G63622	61591 81744	77614	○	61646 81828	49178 ⁷
92-05	Conversión a Motorhome	○	G63622	61591 81744	58622 77614	○	G63623	61646 81828	58623 77623	49178 ⁷
	Cutaway Chassis	○	G63622	61591 81744	58622 77614	○	G63623	61646 81828	58623 77623	49178 ⁷
01-03	Todos	○	G63622	61591 81744	58622 77614	○	G63623	61646 81828	58623 77623	49178 ⁷
03	Exc. Cutaway Chassis	○	G63622	61591 81744	58622 77614	○	G63623	61646 81828	77623 58623	49178 ⁷
	Exc. Paquete de Ambulancia y Manejo	○	G63622	61591 81744	58622 77614	○	G63623	61646 81828	77623 58623	49178 ⁷
92-00	Todos	○	61591 81744	○	61646 81828	49178 ⁷
85-91	Todos	○	70169	○
	Todos	○	58386	34058 ⁸ 70169	○	49178 ⁷
	Conversión a Motorhome	○	G63386	70169	○	G63387
	Exc. Conversión Motorhome	○	61521 ⁶ 81394	58386	34058 ⁸ 70169	○	61647 81285	49178 ⁷
	Exc. Cutaway Chassis	○	70169	○	49178 ⁷
77-84	Todos	○	58386	34058 ⁸	○	49178 ⁷
	Conversión a Motorhome	○	G63386	58386	34058 ⁸	○	G63387	49178 ⁷
	Exc. Cutaway Chassis	○	58386	34058 ⁸	○	49178 ⁷
75-84	Exc. Conversión Motorhome	○	61521 ⁶ 81394	58386	34058 ⁸	○	61647 81285	49178 ⁷
75-76	Conversión a Motorhome	○	G63386	○	G63387
	Exc. Cutaway Chassis	○	○	49178 ⁷
69-74	Todos	○	82012	○	G63377	61519 81484	77377	43058 ⁸ 49127 ⁷

VAN 1 TON, ECONOLINE / CLUB WAGON / SUPERDUTY ESTABILIZADORES DE DIRECCIÓN

		Delantero	Trasero
95-01	Kit de Repuesto	6858SE

VICTORIA

60	Todos	○	82099	○	82076
59	Todos	○	82099	○
57-58	Todos	○	82099	○	81270	49105 ⁷
52-56	Todos	○	82026	○	81270	49105 ⁷
51	Todos	○	82026	○	82156



WINDSTAR

95-03	Todos	○	G55685	○	61625
	Coil(RearSpringType)	○	G55685	○	G63676	61625 81882	43173 ⁸ 49233 ⁷
94-03	Todos	○	G55685	○
	Coil (RearSpring Type)	○	G55685	○	61625

6 Se recomienda que cuando se reemplacen amortiguadores "quad", los 4 sean de la 7 Paquetes en pares; kit de mangueras de aire incluido misma serie.

8 Paquetes en pares

AMORTIGUADORES Y STRUTS

Año	Notas de Aplicación	Front					Rear				
			Ultra	ProGuard\ Guardian	LTV\ Max Control	Protector de Strut\ Bases de Strut	HiJacker\ Soporte\ Hidráulico		Ultra	ProGuard\ Guardian	LTV\ Max Control

FORD

FORD



WINDSTAR READYMOUNTS

							Delantero		Trasero	
95-03	Todos						G56935 ⁴⁰		









GEO

GEO

METRO

89-97	Non-ABS		G55891	142293 ⁵⁴		G55772	142295 ⁵³
-------	---------	---	--------	------	------	----------------------	------	---	--------	------	------	----------------------	------



PRIZM

93-97	Izquierdo		G55999	143281 ⁵³		G55661
	Derecho		G55999	143281 ⁵³		G55662	142229 ⁵³
89-92	Todos		G55591	143281 ⁵³		G55557
	Derecho		G55591	143281 ⁵³		G55557	142229 ⁵³



PRIZM READYMOUNTS

							Delantero		Trasero	
93-97	Izquierdo						G56947 ⁴⁰		G56949 ⁴⁰	
	Derecho						G56947 ⁴⁰		G56950 ⁴⁰	





SPECTRUM

89	Todos		G55719		81558
----	-------	--	--------	------	------	------	------	--	------	-------	------	------	------

STORM

90-93	Non-ABS		G55780	142317 ⁵³		G55776
-------	---------	---	--------	------	------	----------------------	------	---	--------	------	------	------	------





TRACKER

89-97	Todos		142294 ⁵⁴		G63799	61560 81904	49613 ⁷
	Non-ABS		G56518	142294 ⁵⁴		G63799	61560 81904	49613 ⁷

GMC

GMC









ACADIA

13-16	Todos			G64040
07-12	Todos		G52125	143366		G64040





ACADIA READYMOUNTS

							Delantero		Trasero	
07-12	Todos						G57109 ⁴⁰		

CANYON

04-12	RWD, D Standard Suspensión; Exc. Z71 Offroad Package			G63882
10-11	Barra de Torsion(FrontSpringType)			G63879
04-11	RWD, Coil(FrontSpringType) Exc. Paquete Z71 Off Road		G51850	
04-09	Barra de Torsion(FrontSpringType)		G63884		G63879

ENVOY

03-09	Todos		G51718	143241 ⁵³		61717
	Coil(RearSpringType)		G51718	143241 ⁵³		G63842	61717	77971

7 Paquetes en pares; kit de mangueras de aire incluido
 53 Montaje de Strut. Es probable reutilizar algunas partes del E.O.
Texto en Negritas - Número de Parte Nuevo / Futuro

40 Strut ReadyMount. Ensamble Completo
 54 Kit con Montaje y Rodamiento. Es probable que reutilizar algunas partes del E.O.

AMORTIGUADORES Y STRUTS

Año	Notas de Aplicación	From					Rear				
		Ultra	ProGuard\ Guardian	LTV\ Max Control	Protector de Strut\ Bases de Strut	HiJacker\ Soporte\ Hidráulico	Ultra	ProGuard\ Guardian	LTV\ Max Control	Protector de Strut\ Bases de Strut	HiJacker\ Soporte\ Hidráulico

GMC

GMC

ENVOY (cont)

03-06	Air(RearSpringType)	↓	G51718	143241 ⁵³	○	G64014	61717
02	Todos	↓	G51718 ⁴⁵	143241 ⁵³	○	61717
	Coil(RearSpringType)	↓	G51718 ⁴⁵	143241 ⁵³	○	G63842	61717	77971
	Exc. Modelo SS	↓	G51718	143241 ⁵³	○	61717

ENVOY READYMOUNTS

										Delantero	Trasero		
02-09	Todos											G57022

ENVOY XL

02-06	Todos	↓	G51718	○	77971
-------	-------	---	--------	------	------	------	------	---	------	------	-------	------	------

ENVOY XL READYMOUNTS

										Delantero	Trasero		
02-06	Todos											G57022 ⁴⁰

ENVOY XUV

04-05	Todos	↓	G51718	○	77971
-------	-------	---	--------	------	------	------	------	---	------	------	-------	------	------

ENVOY XUV READYMOUNTS

										Delantero	Trasero		
04-05	Todos											G57022 ⁴⁰

JIMMY

05	Todos	↓	○	G63422	81482	58422 77422
	4WD	○	G63423	61531 81516	58423 ⁵⁰ 77423	142316 ⁵³	○	G63422	61528 81482	58422 77422	43162 ⁶ 49213 ⁷
92-04	Todos	↓	142316 ⁵³	○	G63422	61528 81482	58422 77422	43162 ⁶ 49213 ⁷
	4WD	○	G63423	61531 81516	58423 ⁵⁰ 77423	142316 ⁵³	○	G63422	61528 81482	58422 77422	43162 ⁶ 49213 ⁷
	RWD	↓	G63421	61504 81750	58421 77421	142316 ⁵³	34051 ⁸	○	G63422	61528 81482	58422 77422	43162 ⁶ 49213 ⁷
73-91	Exc. Kit de Levantamiento	↓	○	G63349	61524 81164	77349	43111 ⁸ 49155 ⁷
	4WD; Con Kit de Levantamiento de 4"; Exc. Suspensión Quad	○	G63437 ⁵⁰	58437 ⁵⁰	○	G63438 ⁵⁰	58438 ⁵⁰
	4WD; Exc. Suspensión Quad y Kit de Elevación	○	G63347 ⁵⁰	61516 81113	58347	43107 ⁶	○	58349
	4WD; Suspensión Quad Amortiguador Corto; Exc. Kit de Levantamiento	○	G63908 ⁶	58908 ⁶	○
	4WD; Suspensión Quad Amortiguador Largo; Exc. Kit de Levantamiento	○	G63906 ⁶	61522 ⁶ 81496 ⁶	58906 ⁶	○
75-84	RWD	○	G63355	61525 81039	58355 77355	34036 ⁶	○
73-74	RWD	○	G63355	61525 81039	77355	34036 ⁶	○
70-74	RWD	○	58355	○
70-72	4WD	○	○	49107 ⁷
	RWD; Resorte Trasero	○	○	43062 ⁶
	4WD	○	○	G63371

6 Se recomienda que cuando se reemplacen amortiguadores "quad", los 4 sean de la misma serie.

8 Paquetes en pares

45 Strut must be rotated to align notch with lower control arm.

53 Montaje de Strut. Es probable reutilizar algunas partes del E.O.



Texto en Negritas - Número de Parte Nuevo / Futuro

7 Paquetes en pares; kit de mangueras de aire incluido

40 Strut ReadyMount. Ensamble Completo

50 Para proteger la barra del pistón, se recomienda utilizar el kit Bellows No.141242.

AMORTIGUADORES Y STRUTS

Año	Notas de Aplicación										
		Ultra	ProGuard\ Guardian	LTV\ Max Control	Protector de Strut\ Bases de Strut	HiJacker\ Soporte\ Hidráulico	Ultra	ProGuard\ Guardian	LTV\ Max Control	Protector de Strut\ Bases de Strut	HiJacker\ Soporte\ Hidráulico

GMC

GMC

JIMMY (cont)

70-72	4WD; Exc. Suspensión Quad y Kit de Elevación	○	G63347 ⁸⁰	61516 81113	58347	43107 ⁸	○
	RWD	○	G63355	61525 81039	77355	34036 ⁸	○	G63306	82003	43093 ⁸ 49162 ⁷

JIMMY ESTABILIZADORES DE DIRECCIÓN

		Delantero	Trasero
83-04	4WD, Power Steering Estabilizador de Dirección Sistema Sencillo; sin orificio de montaje de EO en brazo de dirección	6851SE
73-91	Amortiguador de reemplazo HD para vehículos con estabilizador de EO	6804SE ⁸⁰
	Amortiguador de reemplazo para vehículos con el kit de montaje de repuesto GRC	6802SE ⁸⁴
	Amortiguador de reemplazo para vehículos con estabilizador de EO	14017
70-72	4WD; Estabilizador de Dirección Sistema Dual K5	6802SE ⁸⁴
	4WD; Estabilizador de Dirección Sistema Sencillo K-5	6803SE ⁸⁴
	RWD	6802SE ⁸⁴

MICROBUS

90	5.7L MFI	○	42961	○
----	----------	---	------	------	------	-------	---	------	------	------	------	------

PICKUP

55-59	Todos	○	82047	○
	Series 100, 150	○	82047	○	82060
	Series 250	○	82047	○	82123
53-54	Todos	○	81270	○
	1/2 y 3/4 Ton	○	81270	○	82155

PICKUP 1/2 TON, C15 / C1500

88-99	Todos	○	G63489	61544 81668	58489 77489	○	G63488	61543 81667	58488 77488	43163 ⁸ 49218 ⁷
88-90	5.7L MFI	○	G63489	61544 81668	58489 77489	42961	○	G63488	61543 81667	58488 77488	42958 43163 ⁸ 49218 ⁷
73-86	Todos	○	G63355	61525 81039	58355 77355	34036 ⁸	○	G63349	61524 81164	58349 77349	43111 ⁸ 49155 ⁷
86	4.8L DOHC, MFI	○	G63355	61525 81039	58355 77355	42961 34036 ⁸	○	G63349	61524 81164	58349 77349	43111 ⁸ 49155 ⁷
82-85	4.8L DOHC, MFI	○	G63355	61525 81039	58355 77355	42961 34036 ⁸	○	G63349	61524 81164	58349 77349	42958 43111 ⁸ 49155 ⁷
81-84	5.7L MFI	○	G63355	61525 81039	58355 77355	42961 34036 ⁸	○	G63349	61524 81164	58349 77349	42958 43111 ⁸ 49155 ⁷
80-84	4.1L 4BBL	○	G63355	61525 81039	58355 77355	34036 ⁸	○	G63349	61524 81164	58349 77349	42958 43111 ⁸ 49155 ⁷
	4.1L 4bbl	○	G63355	61525 81039	58355 77355	42961 34036 ⁸	○	G63349	61524 81164	58349 77349	43111 ⁸ 49155 ⁷
81	4.8L DOHC, MFI	○	G63355	61525 81039	58355 77355	42961 34036 ⁸	○	G63349	61524 81164	58349 77349	43111 ⁸ 49155 ⁷
68-72	Resorte Trasero	○	G63355	61525 81039	58355 77355	34036 ⁸	○	82003	49107 43062 ⁸
67-72	Todos	○	G63355	61525 81039	58355 77355	34036 ⁸	○	43062 ⁸
	Resorte Trasero de Hojas Múltiples	○	G63355	61525 81039	58355 77355	34036 ⁸	○	82006	49162 ⁷ 43062 ⁸
	Leaf(RearSpringType)	○	G63355	61525 81039	58355 77355	34036 ⁸	○	43093 43062 ⁸
	RWD; Resorte Trasero de Hojas Múltiples	○	G63355	61525 81039	58355 77355	34036 ⁸	○	G63306	43062 ⁸
67	Resorte Trasero	○	G63355	61525 81039	58355 77355	34036 ⁸	○	82003	49107 ⁷ 43062 ⁸

7 Paquetes en pares; kit de mangueras de aire incluido

50 Para proteger la barra del pistón, se recomienda utilizar el kit Bellows No.141242.

84 Amortiguador de repuesto para los vehículos con el kit de montaje aftermarket GRC

8 Paquetes en pares

80 No requiere soportes para el montaje, instalar sobre montajes de EO Vea Ref. C para Botas.

AMORTIGUADORES Y STRUTS

Año	Notas de Aplicación	From					Rear				
		Ultra	ProGuard\ Guardian	LTV\ Max Control	Protector de Strut\ Bases de Strut	HiJacker\ Soporte\ Hidráulico	Ultra	ProGuard\ Guardian	LTV\ Max Control	Protector de Strut\ Bases de Strut	HiJacker\ Soporte\ Hidráulico

GMC

GMC

PICKUP 1/2 TON, C15 / C1500 ESTABILIZADORES DE DIRECCIÓN

		Delantero	Trasero
88-99	RWD	6852SE ⁸²
73-86	Estabilizador de Dirección Sistema Sencillo	6802SE ⁸⁴

PICKUP 1/2 TON, K15 / K1500

88-99	Todos	○ G63818	58901 77609	○ G63488	61543 81667	58488 ⁸⁰ 77488	43163 ⁸ 49218 ⁷
81-86	Suspensión Quad Amortiguador Corto; Exc. Kit de Levantamiento	○ G63908 ⁶	58908 ⁵
	Suspensión Quad Amortiguador Largo; Exc. Kit de Levantamiento	○ G63906 ⁶	61522 ⁶ 81496 ⁶	58906 ⁵
75-86	Exc. Suspensión Quad y Kit de Levantamiento	○ G63347	61516 81113	58347	43107 ⁸	○ G63349	61524 81164	58349	43111 ⁸ 49155 ⁷
73-86	Con Kit de Levantamiento de 4"; Exc. Suspensión Quad	○ G63437 ⁵⁰	58437 ⁵⁰	○ G63438 ⁵⁰	58438 ⁵⁰
	Exc. Kit de Levantamiento	○ G63349	61524 81164	77349
73-74	Exc. Suspensión Quad y Kit de Levantamiento	○ G63347	61516 81113	58347	43107 ⁸	○ G63349	61524 81164	58349	49155 ⁷
71-72	Todos	○ G63371	43107 ⁸	○ G63371
	Exc. Suspensión Quad y Kit de Levantamiento	○ G63347	61516 81113	58347	43107 ⁸	○ G63371
69-70	Todos	○ G63347	61516 81113	58347	43107 ⁸	○ G63349	61524 81164	58349	43111 ⁸ 49155 ⁷
	Exc. Suspensión Quad y Kit de Levantamiento	43107 ⁸

PICKUP 1/2 TON, K15 / K1500 ESTABILIZADORES DE DIRECCIÓN

		Delantero	Trasero
88-99	Estabilizador de Dirección Sistema Sencillo	6807SE ⁸⁰
73-86	Todos	14017
	Estabilizador de Dirección Sistema Dual	6802SE ⁸⁴
	Estabilizador de Dirección Sistema Sencillo	6804SE ⁸⁰
69-72	Estabilizador de Dirección Sistema Dual	6802SE ⁸⁴
	Estabilizador de Dirección Sistema Sencillo	6803SE ⁸⁴

PICKUP 1/2 TON, R1500

87	Todos	○ G63355	61525 81039	58355 77355	34036 ⁸	○ G63349	61524 81164	58349 77349	43111 ⁸ 49155 ⁷
----	-------	----------	----------------	----------------	------	--------------------	----------	----------------	----------------	------	--

PICKUP 1/2 TON, R1500 ESTABILIZADORES DE DIRECCIÓN

		Delantero	Trasero
87	Estabilizador de Dirección Sistema Sencillo	6802SE ⁸⁴

PICKUP 1/2 TON, V1500

87	Con Kit de Levantamiento de 4"; Exc. Suspensión Quad	○ G63437 ⁵⁰	58437 ⁵⁰	○ G63438 ⁵⁰	58438 ⁵⁰
	Exc. Kit de Levantamiento	○ G63347	43107 ⁸	○ G63349	61524 81164	58349 77349
	Exc. Suspensión Quad y Kit de Levantamiento	○ G63347	43107 ⁸	○ G63349	61524 81164	58349 77349
	Suspensión Quad Amortiguador Corto; Exc. Kit de Levantamiento	○ G63908 ⁶	61516 81113 ⁶	58908 ⁵
	Suspensión Quad Amortiguador Largo; Exc. Kit de Levantamiento	○ G63906 ⁶	61522 ⁶ 81496 ⁶	58906 ⁵
	Suspensión Quad Exc. Kit de Levantamiento	43111 ⁸ 49155 ⁷

6 Se recomienda que cuando se reemplacen amortiguadores "quad", los 4 sean de la misma serie.

8 Paquetes en pares

80 No requiere soportes para el montaje, instalar sobre montajes de EO Vea Ref. C para Botas.

84 Amortiguador de repuesto para los vehículos con el kit de montaje aftermarket GRC

7 Paquetes en pares; kit de mangueras de aire incluido

50 Para proteger la barra del pistón, se recomienda utilizar el kit Bellows No.141242.

82 Use kit si está señalado. Vea Ref. C para Botas.

AMORTIGUADORES Y STRUTS

Año	Notas de Aplicación	Front					Rear				
		Ultra	ProGuard\ Guardian	LTV\ Max Control	Protector de Strut\ Bases de Strut	HiJacker\ Soporte\ Hidráulico	Ultra	ProGuard\ Guardian	LTV\ Max Control	Protector de Strut\ Bases de Strut	HiJacker\ Soporte\ Hidráulico

GMC

GMC

PICKUP 1/2 TON, V1500 ESTABILIZADORES DE DIRECCIÓN

		Delantero	Trasero
87	Todos	14017
	Estabilizador de Dirección Sistema Dual	6802SE ⁸⁴
	Estabilizador de Dirección Sistema Sencillo	6804SE ⁸⁰

PICKUP 3/4 TON, C25 / C2500

88-00	Todos	⊖	G63489	61544 81668	58489 77489	⊖	G63488	61543 81667	58488 77488	43163 ⁸ 49218 ⁷
88-91	5.7L MFI	⊖	G63489	61544 81668	58489 77489	42961	⊖	G63488	61543 81667	58488 77488	42958 43163 ⁸ 49218 ⁷
87	5.7L MFI	⊖	42961	⊖	42958
85-86	Crew Cab Pickup	⊖	58355 77355	34036 ⁸	⊖	G63366	61649 81174	58366
82-86	Standard Cab Pickup	⊖	58355 77355	34036 ⁸	⊖	G63349	61524 81164	58349 77349	43111 ⁸ 49155 ⁷
79-86	Cab & Chassis	⊖	58355 77355	34036 ⁸	⊖	G63349	61524 81164	58349 77349	43111 ⁸ 49155 ⁷
	Exc. Extended Cab	⊖	G63355	61525 81039	⊖
79-83	Crew Cab Pickup	⊖	58355 77355	34036 ⁸	⊖	G63366	61649 81174	58366
81	Crew Cab Pickup	⊖	34036 ⁸	⊖
	Standard Cab Pickup	⊖	58355 77355	⊖	G63349	61524 81164	58349 77349	43111 ⁸ 49155 ⁷
79-80	Standard Cab Pickup	⊖	58355 77355	34036 ⁸	⊖	G63349	61524 81164	58349 77349	43111 ⁸ 49155 ⁷
75-78	Cab & Chassis	⊖	⊖	61524 81164	58349 77349	43111 ⁸ 49155 ⁷
	Crew Cab Pickup	⊖	⊖	G63366	61649 81174	58366
	Exc. Extended Cab	⊖	G63355	61525 81039	58355 77355	34036 ⁸	⊖	G63349
	Standard Cab Pickup	⊖	⊖	61524 81164	58349 77349	43111 ⁸ 49155 ⁷
73-74	Todos	⊖	G63355	61525 81039	58355 77355	34036 ⁸	⊖	43111 ⁸ 49155 ⁷
	Crew Cab	⊖	G63355	61525 81039	58355 77355	34036 ⁸	⊖	61649	43111 ⁸ 49155 ⁷
	Crew Cab Pickup	⊖	G63355	61525 81039	58355 77355	34036 ⁸	⊖	G63366	43111 ⁸ 49155 ⁷
	Exc. Crew Cab y Bonus Cab	⊖	G63355	61525 81039	58355 77355	34036 ⁸	⊖	G63349	61524	58349 77349	43111 ⁸ 49155 ⁷
67-72	Todos	⊖	G63355	61525 81039	58355 77355	34036 ⁸	⊖	43062 ⁸
	Resorte Trasero	⊖	G63355	61525 81039	58355 77355	34036 ⁸	⊖	82003	49107 ⁷ 43062 ⁸
	Resorte Trasero de Hojas Múltiples	⊖	G63355	61525 81039	58355 77355	34036 ⁸	⊖	82006	49162 ⁷ 43062 ⁸
	Leaf(RearSpringType)	⊖	G63355	61525 81039	58355 77355	34036 ⁸	⊖	43093 43062 ⁸
	RWD; Resorte Trasero de Hojas Múltiples	⊖	G63355	61525 81039	58355 77355	34036 ⁸	⊖	G63306	43062 ⁸
66	Todos	⊖	77355	⊖	82006	43093

PICKUP 3/4 TON, C25 / C2500 ESTABILIZADORES DE DIRECCIÓN

		Delantero	Trasero
92-99	RWD, Exc. Estabilizador de Dirección de EO	6852SE ⁸²
88-91	RWD	6852SE ⁸²
67-86	Estabilizador de Dirección Sistema Sencillo	6802SE ⁸⁴

7 Paquetes en pares; kit de mangueras de aire incluido



8 Paquetes en pares

80 No requiere soportes para el montaje, instalar sobre montajes de EO Vea Ref. C para Botas.

82 Use kit si está señalado. Vea Ref. C para Botas.

84 Amortiguador de repuesto para los vehículos con el kit de montaje aftermarket GRC

AMORTIGUADORES Y STRUTS

Año	Notas de Aplicación	From 					Rear 				
		Ultra	ProGuard/ Guardian	LTV/ Max Control	Protector de Strut/ Bases de Strut	HiJacker/ Soporte/ Hidráulico	Ultra	ProGuard/ Guardian	LTV/ Max Control	Protector de Strut/ Bases de Strut	HiJacker/ Soporte/ Hidráulico

GMC

GMC

PICKUP 3/4 TON, K25 / K2500

88-00	Todos	○	G63609	61542 81726	58609 77609	○	G63488	61543 81667	58488 77488	43163 ⁸ 49218 ⁷
81-86	Suspensión Quad Amortiguador Corto; Exc. Kit de Levantamiento	○	G63908 ⁶	58908 ⁶
	Suspensión Quad Amortiguador Largo; Exc. Kit de Levantamiento	○	G63906 ⁶	61522 ⁶ 81496 ⁶	58906 ⁶
73-86	Con Kit de Levantamiento de 4"; Exc. Suspensión Quad	○	G63437 ⁵⁰	58437 ⁵⁰	○	G63438 ⁵⁰	58438 ⁵⁰
86	Exc. Kit de Levantamiento		○	G63349	61524 81164	77349	43111 ⁸
	Exc. Suspensión Quad y Kit de Levantamiento	○	G63347	61516 81113	58347	43107 ⁸	○	58349	49155 ⁷
73-85	Exc. Kit de Levantamiento		○	G63349	61524 81164	77349
	Exc. Suspensión Quad y Kit de Levantamiento	○	G63347	61516 81113	58347	43107 ⁸	○	58349	43111 ⁸ 49155 ⁷
71-72	Todos		○	G63371
	Exc. Suspensión Quad y Kit de Levantamiento	○	G63347	61516 81113	58347	43107 ⁸	○	G63371
69-70	Exc. Suspensión Quad y Kit de Levantamiento	○	G63347	61516 81113	58347	43107 ⁸	

PICKUP 3/4 TON, K25 / K2500 ESTABILIZADORES DE DIRECCIÓN

		Delantero		Trasero	
99-00	4WD, PBV 9200 con Amortiguador de EO 15059138, 15155638	6853SE ⁸²		
88-99	Estabilizador de Dirección Sistema Sencillo	6807SE ⁸⁰		
73-86	Todos	14017		
	Estabilizador de Dirección Sistema Dual	6802SE ⁸⁴		
	Estabilizador de Dirección Sistema Sencillo	6804SE ⁸⁰		
67-72	Estabilizador de Dirección Sistema Dual	6802SE ⁸⁴		
	Estabilizador de Dirección Sistema Sencillo	6803SE ⁸⁴		

PICKUP 3/4 TON, R2500

87-89	Crew Cab Pickup		○	G63366	61649 81174	58366
	Exc. Crew Cab y Bonus Cab	○	G63355	61525 81039	58355 77355	34036 ⁸	○	G63349	61524 81164	58349 77349

PICKUP 3/4 TON, R2500 ESTABILIZADORES DE DIRECCIÓN

		Delantero		Trasero	
87-89	Estabilizador de Dirección Sistema Sencillo	6802SE ⁸⁴		

PICKUP 3/4 TON, V2500

87	Con Kit de Levantamiento de 4"; Exc. Suspensión Quad	○	G63437 ⁵⁰	58437 ⁵⁰	○	G63438 ⁵⁰	58438 ⁵⁰
	Exc. Kit de Levantamiento	○	G63347	43107 ⁸	○	G63349	61524 81164	58349 77349	43111 ⁸ 49155 ⁷
	Exc. Suspensión Quad y Kit de Levantamiento	○	58347
	Suspensión Quad Amortiguador Corto; Exc. Kit de Levantamiento	○	G63908 ⁶	61516 81113 ⁶	58908 ⁶
	Suspensión Quad Amortiguador Largo; Exc. Kit de Levantamiento	○	G63906 ⁶	61522 ⁶ 81496 ⁶	58906 ⁶

PICKUP 3/4 TON, V2500 ESTABILIZADORES DE DIRECCIÓN

		Delantero		Trasero	
87	Todos	14017		
	AN49	6802SE ⁸⁴		
	Estabilizador de Dirección Sistema Sencillo	6804SE ⁸⁰		

6 Se recomienda que cuando se reemplacen amortiguadores "quad", los 4 sean de la misma serie.

8 Paquetes en pares

80 No requiere soportes para el montaje, instalar sobre montajes de EO Vea Ref. C para Botas.



84 Amortiguador de repuesto para los vehículos con el kit de montaje aftermarket GRC

7 Paquetes en pares; kit de mangueras de aire incluido

50 Para proteger la barra del pistón, se recomienda utilizar el kit Bellows No.141242.

82 Use kit si está señalado. Vea Ref. C para Botas.





























AMORTIGUADORES Y STRUTS

Año	Notas de Aplicación	Front					Rear					
				Ultra	ProGuard/ Guardian	LTV/ Max Control	Protector de Strut/ Bases de Strut	HiJacker/ Soporte/ Hidráulico		Ultra	ProGuard/ Guardian	LTV/ Max Control

GMC

GMC

PICKUP 1 TON, C35/3500

01-02	Todos		43163
	Eje Delantero Rígido		G63488	77488	43163
	Extended & Standard Cab; Eje Delantero Rígido HD		81667	43163
98-00	Eje Delantero Rígido HD		81668	77488
	Cab & Chassis Eje Delantero Rígido HD		G63812	58488 77488	49218 ⁷
93-00	Standard Cab Pickup Eje Delantero Rígido HD		G63489	61544	58489	G63488	77488
92-00	Todos		77488
	Crew Cab Pickup Eje Delantero Rígido HD		G63489	61544	58489	G63488	77488
	Eje Delantero Rígido HD		58812	61543	77488	43163 ⁹
	Exc. Cab y Chassis; Crew Cab y Eje Delantero Rígido HD		77489	81667	77488
92-97	Eje Delantero Rígido HD		81668	58488 77488
	Cab & Chassis Eje Delantero Rígido HD		G63812	77488	49218 ⁷
92	Standard Cab Pickup Eje Delantero Rígido HD		G63489	61544	58489 77489	G63488	77488
91	Todos		77488	42958
	Eje Delantero Rígido HD		81668	58488 77488	49218 ⁷ 42958
	5.7L MFI		42961	77488	42958
	Cab & Chassis		81039	77355	77488	42958
	Cab & Chassis Eje Delantero Rígido HD		G63812	61525	34036 ⁸	77488	42958
	Cab & Chassis Exc. Eje Rígido Delantero HD		G63366	61649 81174	58366 77488	42958
	Eje Delantero Rígido HD		58812	61543	77488	43163 ⁹ 42958
	Exc. Cab y Chassis; Crew Cab y Eje Delantero Rígido HD		81667	77488	42958
	Extended Cab Pickup Eje Delantero Rígido HD		G63489	61544	58489 77489	G63488	77488	42958
	Standard Cab Pickup Eje Delantero Rígido HD		G63489	61544	58489 77489	G63488	77488	42958
89-90	Exc. Cab y Chassis; Crew Cab y Eje Delantero Rígido HD		81667	42958
88-90	Todos			42958
	Eje Delantero Rígido HD		81668	58488	49218 ⁷ 42958
	Cab & Chassis		81039	77355	34036 ⁸	42958
	Cab & Chassis Eje Delantero Rígido HD		61525	58355		42958
	Cab & Chassis Exc. Eje Rígido Delantero HD		G63355	G63366	61649 81174	58366	42958
	Extended Cab Pickup Eje Delantero Rígido HD		G63489	61544	58489 77489	G63488	61543	77488	43163 ⁹ 42958
Standard Cab Pickup Eje Delantero Rígido HD		G63489	61544	58489 77489	G63488	61543	77488	43163 ⁹ 42958	
86-90	5.7L MFI		42961	42958
88	Exc. Cab y Chassis y Eje Delantero Rígido HD		81667	42958

7 Paquetes en pares; kit de mangueras de aire incluido

8 Paquetes en pares

AMORTIGUADORES Y STRUTS

Año	Notas de Aplicación	From					Rear				
		Ultra	ProGuard\ Guardian	LTV\ Max Control	Protector de Strut\ Bases de Strut	HiJacker\ Soporte\ Hidráulico	Ultra	ProGuard\ Guardian	LTV\ Max Control	Protector de Strut\ Bases de Strut	HiJacker\ Soporte\ Hidráulico

GMC

GMC

PICKUP 1 TON, C35/3500 (cont)

81-85	5.7L MFI	○	61525	42961	○	42958
80-85	Todos	○	61525	○
80	5.7L MFI	○	61525	○	42958
73-78	Todos	○	G63355	61525 81039	58355 77355	34036 ⁶	○	G63366	61649 81174	58366
67-72	Todos	○	G63355	61525 81039	58355 77355	34036 ⁶	○
	Exc. Eje Trasero 11,000#	○	G63355	61525 81039	58355 77355	34036 ⁶	○	G63306	82006	43093 ⁶ 49162 ⁷

PICKUP 1 TON, C35/3500 ESTABILIZADORES DE DIRECCIÓN

		Delantero	Trasero
91-93	Estabilizador de Dirección Sistema Sencillo Pickup HD	6807SE ⁸⁰
75-86	Crew Cab Pickup	6802SE ⁸⁴
72-74	Todos	6802SE ⁸⁴

PICKUP 1 TON, K35 / K3500

88-00	Todos	○	G63609	61542 81726	58609 77609	○	G63488	61543 81667	58488 77488	43163 ⁶ 49218 ⁷
77-86	Todos	○	G63411	58411	○	G63675	61642 81921	58412 77412

PICKUP 1 TON, K35 / K3500 ESTABILIZADORES DE DIRECCIÓN

		Delantero	Trasero
88-99	Estabilizador de Dirección Sistema Sencillo	6807SE ⁸⁰
77-86	Todos	14017
73-74	Todos	14017

PICKUP 1 TON, R3500

87-91	Todos	○	G63355	61525 81039	58355 77355	34036 ⁶	○	G63366	61649 81174	58366
-------	-------	---	--------	----------------	----------------	-------	--------------------	---	--------	----------------	-------	-------	-------

PICKUP 1 TON, V3000 / V3500

87-91	Todos	○	G63411	58411	○	G63675	61642 81921	58412 77412
87-88	Suspensión Quad Amortiguador Largo; Exc. Kit de Levantamiento	○	G63411	81496 ⁶	58411	○	G63675	61642 81921	58412 77412

PICKUP 1 TON, V3000 / V3500 ESTABILIZADORES DE DIRECCIÓN

		Delantero	Trasero
87-91	Todos	14017

PICKUP 1000 SERIES

63-65	Todos	○	G63355	61525 81039	58355	34036 ⁶	○	G63306	82006	43093 ⁶ 49162 ⁷
61-62	Todos	○	82035	○	82086

PICKUP 1500 SERIES

63-65	Todos	○	G63355	61525 81039	58355 77355	34036 ⁶	○	G63306	82006	43093 ⁶ 49162 ⁷
61-62	Todos	○	82035	○	82086

PICKUP 2500 SERIES

61-62	Todos	○	82035	○
-------	-------	---	-------	-------	-------	-------	-------	---	-------	-------	-------	-------	-------

PICKUP ESTABILIZADORES DE DIRECCIÓN

		Delantero	Trasero
53-59	Estabilizador de Dirección Sistema Sencillo c/ Eje de Viga en I	6802SE ⁸⁴

6 Se recomienda que cuando se reemplacen amortiguadores "quad", los 4 sean de la misma serie.

8 Paquetes en pares

84 Amortiguador de repuesto para los vehículos con el kit de montaje aftermarket

GRC

7 Paquetes en pares; kit de mangueras de aire incluido
80 No requiere soportes para el montaje, instalar sobre montajes de EO Vea Ref. C para Botas.

AMORTIGUADORES Y STRUTS

Año	Notas de Aplicación	Front					Rear				
		Ultra	ProGuard\ Guardian	LTV\ Max Control	Protector de Strut\ Bases de Strut	HiJacker\ Soporte\ Hidráulico	Ultra	ProGuard\ Guardian	LTV\ Max Control	Protector de Strut\ Bases de Strut	HiJacker\ Soporte\ Hidráulico

GMC

GMC

SIERRA 1500 ESTABILIZADORES DE DIRECCIÓN

		Delantero	Trasero
99-05	4WD, Exc. Estabilizador de Dirección de EO	6853SE ⁸²

SIERRA 1500 HD

05-06	Todos	⊥ ○ G63817	61663 81925	58817 77817	○ G63675	61642 81921	58412 77412
01-03	Todos	⊥ ○ G63817	61663 81925	58817 77817	○ G63675	61642 81921	58412 77412

SIERRA 1500 HD CLASSIC

07	4WD; Classic y Old Body Style; Exc. Suspensión Electrónica Ajustable	⊥ n	58803
----	--	--------	------	-------	------	------	------	------	------	------	------

SIERRA 1500 READYMOUNTS

		Delantero	Trasero
07-13	4WD, Exc. Control de Manejo Electrónico	G57000 ⁴⁰
	RWD, Crew Cab Pickup Exc. Control de Manejo Electrónico	G57000 ⁴⁰
	RWD, Extended Cab Pickup Exc. Control de Manejo Electrónico	G57000 ⁴⁰
	RWD; Exc. Modelo Classic y Electronic Ride	G57023⁴⁰

SIERRA 2500

99-04	Todos	⊥ ○	58817	○ G63675	61642 81921	58412 77412
	4WD	⊥ ○ G63817	61663 81925	77817 58817	○ G63675	61642 81921	58412 77412

SIERRA 2500 ESTABILIZADORES DE DIRECCIÓN

		Delantero	Trasero
99-04	4WD, Hasta PBV 8600#, Exc. Estabilizador de Dirección de EO	6853SE ⁸²

SIERRA 2500 HD

14	Todos	⊥ ○	⊥ ↑ G64121
11-13	Todos	⊥ ○	⊥ ↑ G64121	58943
01-10	Todos	⊥ ○ G63817	61663 81925	58817 77817	○ G63675	61642 81921	58412 77412

SIERRA 2500 HD ESTABILIZADORES DE DIRECCIÓN

		Delantero	Trasero
11-13	Todos	14075
01-09	4WD, PBV 9200 con Amortiguador de EO 15059138, 15155638	6853SE ⁸²

SIERRA 3500

01-06	Todos	⊥ ○ G63817	61663 81925	58817 77817	○ G63675	61642 81921	58412 77412
-------	-------	---------------	----------------	----------------	------	------	----------	----------------	----------------	------	------

SIERRA 3500 HD

14	Todos	⊥ ○	⊥ ↑ G64121
11-13	Todos	⊥ ○	⊥ ↑ G64121	58943
07-10	Todos	⊥ ○	○ G63675	61642 81921	58412 77412
	Barra de Torsion(FrontSpringType)	⊥ ○ G63817	61663 81925	58817 77817	○ G63675	61642 81921	58412 77412

SIERRA 3500 HD ESTABILIZADORES DE DIRECCIÓN

		Delantero	Trasero
11-13	Todos	14075

SONOMA / S15



83-04	4WD	⊥ ○ G63423	61531 81516	58423 77423	⊥ ○ G63422	61528 81482	58422 77422	43162 ⁸ 49213 ⁷
82-04	Todos	⊥ ○	⊥ ○ G63422	61528 81482	58422 77422	43162 ⁸ 49213 ⁷
	RWD	⊥ ○ G63421	61504 81750	58421 77421	34051 ⁸	⊥ ○ G63422	61528 81482	58422 77422	43162 ⁸ 49213 ⁷

7 Paquetes en pares; kit de mangueras de aire incluido
40 Strut ReadyMount. Ensamble Completo

8 Paquetes en pares
82 Use kit si está señalado. Vea Ref. C para Botas.

Texto en Negritas - Número de Parte Nuevo / Futuro

AMORTIGUADORES Y STRUTS

Año	Notas de Aplicación										
		Ultra	ProGuard\ Guardian	LTV\ Max Control	Protector de Strut\ Bases de Strut	HiJacker\ Soporte\ Hidráulico	Ultra	ProGuard\ Guardian	LTV\ Max Control	Protector de Strut\ Bases de Strut	HiJacker\ Soporte\ Hidráulico

GMC

GMC

SONOMA / S15 (cont)

88-94	4WD, Barra de Torsion(FrontSpringType)	142316 ⁸³	⊖ ⊕	G63422	61528 81482	58422 77422	43162 ⁸ 49213 ⁷
-------	--	-------	-------	-------	----------------------	-------	--------	--------	----------------	----------------	-------	-------	--

SONOMA / S15 ESTABILIZADORES DE DIRECCIÓN

							Delantero	Trasero
91-93	Estabilizador de Dirección Sistema Sencillo; con orificio de montaje de EO en brazo de dirección						6801SE ⁸⁰
82-93	RWD, Estabilizador de Dirección Sistema Sencillo						6802SE ⁸⁴
83-90	4WD, Power Steering Estabilizador de Dirección Sistema Sencillo; sin orificio de montaje de EO en brazo de dirección						6851SE
82-90	RWD, Estabilizador de Dirección Sistema Sencillo; con orificio de montaje de EO en brazo de dirección						6801SE

SPRINT / CABALLERO

78-87	Todos	⊖ ⊕	61504
	RWD	⊖ ⊕	G63421	81750 61504	58421 77421	43060 ⁸ 49334 ⁸⁰
71-77	Todos	⊖ ⊕	G63421	61504 81750	58421 77421	43060 ⁸ 49152 ⁸⁰
	RWD	⊖ ⊕	G63421	61504 81750	58421 77421	43060 ⁸ 49152 ⁸⁰

SPRINT / CABALLERO ESTABILIZADORES DE DIRECCIÓN

							Delantero	Trasero
73-77	Todos						14019

SUBURBAN 1/2 TON, C15 / C1500

93-99	Todos	⊖ ⊕	G63489	61544 81668	58489 77489	⊖ ⊕	G63896	61565 81789	58638 77638	43180 ⁸ 49231 ⁷
92	Todos	⊖ ⊕	G63489	61544 81668	58489 77489	⊖ ⊕	61565 81789	58638 77638	43180 ⁸ 49231 ⁷
	Old Body Style	⊖ ⊕	G63489	61544 81668	58489 77489	⊖ ⊕	G63896	61565 81789	58638 77638	43180 ⁸ 49231 ⁷
75-86	Todos	⊖ ⊕	G63355	61525 81039	58355 77355	34036 ⁸	⊖ ⊕	G63349	61524 81164	58349 77349	43111 ⁸ 49155 ⁷
73-74	Todos	⊖ ⊕	G63355	81039	58355 77355	34036 ⁸	⊖ ⊕	G63349	61524 81164	58349 77349	43111 ⁸ 49155 ⁷
	Resortes Helicoidales Delanteros	⊖ ⊕	G63355	61525 81039	58355 77355	34036 ⁸	⊖ ⊕	G63349	61524 81164	58349 77349	43111 ⁸ 49155 ⁷
68-72	Todos	⊖ ⊕	G63355	58355 77355	34036 ⁸	⊖ ⊕	43062 ⁸
	Resorte Trasero	⊖ ⊕	G63355	58355 77355	34036 ⁸	⊖ ⊕	82003	49107 ⁷ 43062 ⁸
	Resortes Helicoidales Delanteros	⊖ ⊕	G63355	61525 81039	58355 77355	34036 ⁸	⊖ ⊕	43062 ⁸

SUBURBAN 1/2 TON, C15 / C1500 ESTABILIZADORES DE DIRECCIÓN

							Delantero	Trasero
92-99	RWD, Exc. Estabilizador de Dirección de EO						6852SE ⁸²
68-86	Estabilizador de Dirección Sistema Sencillo						6802SE ⁸⁴

SUBURBAN 1/2 TON, K15 / K1500

92-99	Todos	⊖ ⊕	G63609	61542 81726	58609 ⁵⁰ 77609	⊖ ⊕	G63638	61565 81789	58638 ⁵⁰ 77638	43180 ⁸ 49231 ⁷
85-86	Exc. Kit de Levantamiento	⊖ ⊕	⊖ ⊕	G63349	61524 81164	77349
	Exc. Suspensión Quad y Kit de Levantamiento	⊖ ⊕	G63347	61516 81113	58347	43107 ⁸	⊖ ⊕	58349	43111 ⁸ 49155 ⁷
81-86	Suspensión Quad Amortiguador Corto; Exc. Kit de Levantamiento	⊖ ⊕	G63908 ⁶	58908 ⁶	⊖ ⊕
	Suspensión Quad Amortiguador Largo; Exc. Kit de Levantamiento	⊖ ⊕	G63906 ⁶	61522 ⁶ 81496 ⁶	58906 ⁶	⊖ ⊕

6 Se recomienda que cuando se reemplacen amortiguadores "quad", los 4 sean de la misma serie.

8 Paquetes en pares

50 Para proteger la barra del pistón, se recomienda utilizar el kit Bellows No.141242.

80 No requiere soportes para el montaje, instalar sobre montajes de EO Vea Ref. C para Botas.

84 Amortiguador de repuesto para los vehículos con el kit de montaje aftermarket GRC

7 Paquetes en pares; kit de mangueras de aire incluido

30 Para Vehículos GM equipados con sistemas de nivelación de fábrica, vea Ref. A.

53 Montaje de Strut. Es probable reutilizar algunas partes del E.O.

82 Use kit si está señalado. Vea Ref. C para Botas.

AMORTIGUADORES Y STRUTS

Año	Notas de Aplicación	From					Rear				
		Ultra	ProGuard\ Guardian	LTV\ Max Control	Protector de Strut\ Bases de Strut	HiJacker\ Soporte\ Hidráulico	Ultra	ProGuard\ Guardian	LTV\ Max Control	Protector de Strut\ Bases de Strut	HiJacker\ Soporte\ Hidráulico

GMC

GMC

SUBURBAN 1/2 TON, K15 / K1500 (cont)

73-86	Con Kit de Levantamiento de 4"; Exc. Suspensión Quad	○	G63437 ⁵⁰	58437 ⁵⁰	○	G63438 ⁵⁰	58438 ⁵⁰
84	Exc. Kit de Levantamiento	○	○	G63349	61524 81164	77349	43111 ⁸
	Exc. Suspensión Quad y Kit de Levantamiento	○	G63347	61516 81113	58347	43107 ⁸	○	58349	49155 ⁷
73-83	Exc. Kit de Levantamiento	○	○	G63349	61524 81164	77349
	Exc. Suspensión Quad y Kit de Levantamiento	○	G63347	61516 81113	58347	43107 ⁸	○	58349	43111 ⁸ 49155 ⁷
71-72	Todos	○	○	G63371
	Exc. Suspensión Quad y Kit de Levantamiento	○	G63347	61516 81113	58347	43107 ⁸	○	G63371
69-70	Exc. Suspensión Quad y Kit de Levantamiento	○	G63347	61516 81113	58347	43107 ⁸	○

SUBURBAN 1/2 TON, K15 / K1500 ESTABILIZADORES DE DIRECCIÓN

		Delantero		Trasero	
92-95	Estabilizador de Dirección Sistema Sencillo	6807SE ⁸⁰		
73-86	Todos	14017		
	Estabilizador de Dirección Sistema Dual	6802SE ⁸⁴		
	Estabilizador de Dirección Sistema Sencillo	6804SE ⁹⁰		
68-72	Estabilizador de Dirección Sistema Dual	6802SE ⁸⁴		
	Estabilizador de Dirección Sistema Sencillo	6803SE ⁸⁴		

SUBURBAN 1/2 TON, R1500

87-91	Todos	○	G63355	61525 81039	58355 77355	34036 ⁸	○	G63349	61524 81164	58349 77349	43111 ⁸ 49155 ⁷
-------	-------	---	--------	----------------	----------------	------	--------------------	---	--------	----------------	----------------	------	--

SUBURBAN 1/2 TON, R1500 ESTABILIZADORES DE DIRECCIÓN

		Delantero		Trasero	
87-91	Estabilizador de Dirección Sistema Sencillo	6802SE ⁸⁴		

SUBURBAN 1/2 TON, V1500

87-91	Con Kit de Levantamiento de 4"; Exc. Suspensión Quad	○	G63437 ⁵⁰	58437 ⁵⁰	○	G63438 ⁵⁰	58438 ⁵⁰
	Exc. Kit de Levantamiento	○	G63347	43107 ⁸	○	G63349	61524 81164	58349 77349	43111 ⁸ 49155 ⁷
	Exc. Suspensión Quad y Kit de Levantamiento	○	58347	○
	Suspensión Quad Amortiguador Corto; Exc. Kit de Levantamiento	○	G63908 ⁶	61516 81113 ⁶	58908 ⁶	○
	Suspensión Quad Amortiguador Largo; Exc. Kit de Levantamiento	○	G63906 ⁶	61522 ⁶ 81496 ⁶	58906 ⁶	○

SUBURBAN 1/2 TON, V1500 ESTABILIZADORES DE DIRECCIÓN

		Delantero		Trasero	
87-91	Todos	14017		
	Estabilizador de Dirección Sistema Dual	6802SE ⁸⁴		
	Estabilizador de Dirección Sistema Sencillo	6804SE ⁹⁰		

SUBURBAN 3/4 TON, C25 / C2500

92-99	Todos	○	G63489	61544 81668	58489 77489	○	G63896	61565 81789	58638 77638	43180 ⁸ 49231 ⁷
75-86	Todos	○	G63355	61525 81039	58355 77355	34036 ⁸	○	G63349	61524 81164	58349 77349	43111 ⁸ 49155 ⁷
73-74	Todos	○	G63355	61525 81039	58355 77355	34036 ⁸	○	58349	43111 ⁸ 49155 ⁷
	Exc. Crew Cab y Bonus Cab	○	G63355	61525 81039	58355 77355	34036 ⁸	○	G63349	61524 81164	58349	43111 ⁸ 49155 ⁷

6 Se recomienda que cuando se reemplacen amortiguadores "quad", los 4 sean de la misma serie.

8 Paquetes en pares



80 No requiere soportes para el montaje, instalar sobre montajes de EO Veia Ref. C para Botas.

7 Paquetes en pares; kit de mangueras de aire incluido

50 Para proteger la barra del pistón, se recomienda utilizar el kit Bellows No.141242.

84 Amortiguador de repuesto para los vehículos con el kit de montaje aftermarket GRC

AMORTIGUADORES Y STRUTS

Año	Notas de Aplicación										
		Ultra	ProGuard\ Guardian	LTV\ Max Control	Protector de Strut\ Bases de Strut	HiJacker\ Soporte\ Hidráulico	Ultra	ProGuard\ Guardian	LTV\ Max Control	Protector de Strut\ Bases de Strut	HiJacker\ Soporte\ Hidráulico

GMC

GMC

SUBURBAN 3/4 TON, C25 / C2500 (cont)

68-72	Todos	<input type="radio"/>	G63355	61525 81039	58355 77355	34036 ⁸	<input type="radio"/>	82003	43062 ⁸ 49107 ⁷
-------	-------	-----------------------	--------	----------------	----------------	------	--------------------	-----------------------	------	-------	------	------	--

SUBURBAN 3/4 TON, C25 / C2500 ESTABILIZADORES DE DIRECCIÓN

										Delantero	Trasero		
68-86	Estabilizador de Dirección Sistema Sencillo											6802SE ⁸⁴

SUBURBAN 3/4 TON, K25 / K2500

92-99	Todos	<input type="radio"/>	G63609	61542 81726	58609 77609	<input type="radio"/>	G63638	61565 81789	58638 77638	43180 ⁸ 49231 ⁷
81-86	Suspensión Quad Amortiguador Corto; Exc. Kit de Levantamiento	<input type="radio"/>	G63908 ⁶	58908 ⁶	<input type="radio"/>
	Suspensión Quad Amortiguador Largo; Exc. Kit de Levantamiento	<input type="radio"/>	G63906 ⁶	61522 ⁶ 81496 ⁶	58906 ⁶	<input type="radio"/>
73-86	Con Kit de Levantamiento de 4"; Exc. Suspensión Quad	<input type="radio"/>	G63437 ⁵⁰	58437 ⁵⁰	<input type="radio"/>	G63438 ⁵⁰	58438 ⁵⁰
	Exc. Kit de Levantamiento	<input type="radio"/>	<input type="radio"/>	G63349	61524 81164	77349
	Exc. Suspensión Quad y Kit de Levantamiento	<input type="radio"/>	G63347	61516 81113	58347	43107 ⁸	<input type="radio"/>	58349	43111 ⁸ 49155 ⁷
71-72	Todos	<input type="radio"/>	<input type="radio"/>	G63371
	Exc. Suspensión Quad y Kit de Levantamiento	<input type="radio"/>	G63347	61516 81113	58347	43107 ⁸	<input type="radio"/>	G63371
69-70	Exc. Suspensión Quad y Kit de Levantamiento	<input type="radio"/>	G63347	61516 81113	58347	43107 ⁸	<input type="radio"/>

SUBURBAN 3/4 TON, K25 / K2500 ESTABILIZADORES DE DIRECCIÓN

										Delantero	Trasero		
92-97	Estabilizador de Dirección Sistema Sencillo											6807SE ⁸⁰
73-86	Todos											14017
	Estabilizador de Dirección Sistema Dual											6802SE ⁸⁴
	Estabilizador de Dirección Sistema Sencillo											6804SE ⁸⁰
68-72	Estabilizador de Dirección Sistema Dual											6802SE ⁸⁴
	Estabilizador de Dirección Sistema Sencillo											6803SE ⁸⁴

SUBURBAN 3/4 TON, R2500

87-91	Todos	<input type="radio"/>	G63355	61525 81039	58355 77355	34036 ⁸	<input type="radio"/>	G63349	61524 81164	58349 77349	43111 ⁸ 49155 ⁷
-------	-------	-----------------------	--------	----------------	----------------	------	--------------------	-----------------------	--------	----------------	----------------	------	--

SUBURBAN 3/4 TON, R2500 ESTABILIZADORES DE DIRECCIÓN

										Delantero	Trasero		
87-91	Estabilizador de Dirección Sistema Sencillo											6802SE ⁸⁴

SUBURBAN 3/4 TON, V2500

87-91	Con Kit de Levantamiento de 4"; Exc. Suspensión Quad	<input type="radio"/>	G63437 ⁵⁰	58437 ⁵⁰	<input type="radio"/>	G63438 ⁵⁰	58438 ⁵⁰
	Exc. Kit de Levantamiento	<input type="radio"/>	G63347	43107 ⁸	<input type="radio"/>	G63349	61524 81164	58349 77349	43111 ⁸ 49155 ⁷
	Exc. Suspensión Quad y Kit de Levantamiento	<input type="radio"/>	58347	<input type="radio"/>
	Suspensión Quad Amortiguador Corto; Exc. Kit de Levantamiento	<input type="radio"/>	G63908 ⁶	61516 81113 ⁶	58908 ⁶	<input type="radio"/>
	Suspensión Quad Amortiguador Largo; Exc. Kit de Levantamiento	<input type="radio"/>	G63906 ⁶	61522 ⁶ 81496 ⁶	58906 ⁶	<input type="radio"/>

SUBURBAN 3/4 TON, V2500 ESTABILIZADORES DE DIRECCIÓN

										Delantero	Trasero		
87-91	Todos											14017
	Estabilizador de Dirección Sistema Dual											6802SE ⁸⁴
	Estabilizador de Dirección Sistema Sencillo											6804SE ⁸⁰

6 Se recomienda que cuando se reemplacen amortiguadores "quad", los 4 sean de la misma serie.

8 Paquetes en pares

80 No requiere soportes para el montaje, instalar sobre montajes de EO Ve a Ref. C para Botas.

7 Paquetes en pares; kit de mangueras de aire incluido

50 Para proteger la barra del pistón, se recomienda utilizar el kit Bellows No.141242.

84 Amortiguador de repuesto para los vehículos con el kit de montaje aftermarket

GR C

AMORTIGUADORES Y STRUTS

Año	Notas de Aplicación	Front					Rear				
		Ultra	ProGuard\ Guardian	LTV\ Max Control	Protector de Strut\ Bases de Strut	HiJacker\ Soporte\ Hidráulico	Ultra	ProGuard\ Guardian	LTV\ Max Control	Protector de Strut\ Bases de Strut	HiJacker\ Soporte\ Hidráulico

GMC

GMC

SYCLONE

91	Todos	○	G63423	61531 81516	58423 77423	○	G63422	61528 81482	58422 77422	49213 ⁷
	AWD	○	G63423	61531 81516	58423 77423	○	G63422	61528 81482	58422 77422	43162 ⁸ 49213 ⁷
	Barra de Torsion(FrontSpringType)	○	G63423	61531 81516	58423 77423	142316 ⁵³	○	G63422	61528 81482	58422 77422

SYCLONE ESTABILIZADORES DE DIRECCIÓN

		Delantero	Trasero
91	Estabilizador de Dirección Sistema Sencillo; con orificio de montaje de EO en brazo de dirección	6801SE ⁸⁰

TERRAIN

14-16	Todos	↑	G64140
13	Todos	○	G64015	61718
12	Izquierdo	↓	G52127	○	G64015	61718
	Derecho	↓	G52128	○	G64015	61718
10-11	Izquierdo	↓	G52127	143469 ⁵³	○	G64015	61718
	Derecho	↓	G52128	143469 ⁵³	○	G64015	61718

TRACKER

89-91	Todos	↓	81904
-------	-------	------	------	------	------	------	------	---	------	-------	------	------	------	------

TYPHOON

92-93	Todos	○	G63423	61531 81516	58423 77423	142316 ⁵³	○	G63422	61528 81482	58422 77422	43162 ⁸ 49213 ⁷
-------	-------	---	--------	----------------	----------------	----------------------	------	------	---	--------	----------------	----------------	------	------	--

TYPHOON ESTABILIZADORES DE DIRECCIÓN

		Delantero	Trasero
92-93	Estabilizador de Dirección Sistema Sencillo; sin orificio de montaje de EO en brazo de dirección	6851SE

VAN 1/2 TON, G / SAVANNA



12-14	AWD, Barra de Torsion(FrontSpringType)	↓	61683		
	RWD	77638		
	RWD, Coil(FrontSpringType)	↓	61684		
10-11	Barra de Torsion (FrontSpringType)	↓	61683	○	G63896	61686	58638	43180 ⁸ 49231 ⁷	
08-11	Todos	○	G63896	61686	58638	43180 ⁸ 49231 ⁷	
	Exc. Upfitter Package y Cutaway Chassis	○	G63896	61565 61686	58638	43180 ⁸ 49231 ⁷	
	Barra de Torsión (Suspensión de Resorte Delantera)	↓	G63893	○	G63896	61686	58638	43180 ⁸ 49231 ⁷	
	RWD	○	G63896	81789 61686	77638 58638	43180 ⁸ 49231 ⁷	
	RWD, Coil(FrontSpringType)	↓	G63894	61684	○	G63896	61686	58638	43180 ⁸ 49231 ⁷
	Barra de Torsion(FrontSpringType)	↓	61683	○	G63896	61686	58638	43180 ⁸ 49231 ⁷
07	Todos	○	G63896	61686	43180 ⁸ 49231 ⁷	
	Exc. Upfitter Package y Cutaway Chassis	○	G63896	61565 61686	43180 ⁸ 49231 ⁷	
	Barra de Torsión (Suspensión de Resorte Delantera)	↓	G63893	○	G63896	61686	43180 ⁸ 49231 ⁷	
	RWD	○	G63896	81789 61686	77638	43180 ⁸ 49231 ⁷	

7 Paquetes en pares; kit de mangueras de aire incluido
53 Montaje de Strut. Es probable reutilizar algunas partes del E.O.

8 Paquetes en pares
80 No requiere soportes para el montaje, instalar sobre montajes de EO Vea Ref. C para Botas.

Texto en Negritas - Número de Parte Nuevo / Futuro

































AMORTIGUADORES Y STRUTS

Año	Notas de Aplicación	Front					Rear				
			Ultra	ProGuard/ Guardian	LTV/ Max Control	Protector de Strut/ Bases de Strut	HiJacker/ Soporte/ Hidráulico		Ultra	ProGuard/ Guardian	LTV/ Max Control

GMC

GMC











VAN 1/2 TON, G / SAVANNA (cont)

07	RWD, Coil(FrontSpringType)		G63894	61684		G63896	61686	43180 ⁸ 49231 ⁷
	Barra de Torsion(FrontSpringType)		61683		G63896	61686	43180 ⁸ 49231 ⁷
03-06	Todos			G63896	61686	58638	43180 ⁸ 49231 ⁷
	Exc. Upfitter Package y Cutaway Chassis			G63896	61565 61686	58638	43180 ⁸ 49231 ⁷
	Barra de Torsión (Suspensión de Resorte Delantera)		G63893	61683		G63896	61686	58638	43180 ⁸ 49231 ⁷
	RWD			G63896	81789 61686	77638 58638	43180 ⁸ 49231 ⁷
	RWD, Coil(FrontSpringType)		G63894	61684		G63896	61686	58638	43180 ⁸ 49231 ⁷
03	Barra de Torsion (FrontSpringType)		61683		G63896	61686	58638	43180 ⁸ 49231 ⁷
96-02	Todos		61555		G63896	61565	58638	43180 ⁸ 49231 ⁷
	RWD		G63375 ⁵	81713 ⁵ 61555	77375		G63896	81789 61565	77638 58638	43180 ⁸ 49231 ⁷
78-95	Todos		G63357	61517 81108	58357 77357		G63413	61522 81496	58413 77413	49212 ⁷
71-77	Todos		G63357	61517 81108	58357 77357		G63306	82006	43093 ⁸ 49162 ⁷
70	Todos		58357		G63306	82006	43093 ⁸ 49162 ⁷
	Eje Delantero con Viga en I		82062	58357		G63306	82006	43093 ⁸ 49162 ⁷
	Suspensión Delantera Independiente		G63357	61517 81108	77357 58357		G63306	82006	43093 ⁸ 49162 ⁷
67-69	Todos		82062		G63306	82006	43093 ⁸ 49162 ⁷
64-66	Todos		82062		82003

















VAN 1/2 TON, G / SAVANNA ESTABILIZADORES DE DIRECCIÓN

		Delantero	Trasero
70-95	Estabilizador de Dirección Sistema Sencillo	6802SE ⁸⁴

VAN 1/2 TON, P SERIES

74-80	Todos		G63355	61525 81039	58355 77355	34036 ⁸		G63366	61649 81174	58366 77662
73	Todos		G63355	61525 81039	58355 77355	34036 ⁸		G63349	61524 81164	58349 77349	43111 ⁵ 49155 ⁷
68-72	Todos		G63355	61525 81039	58355 77355	34036 ⁸		82003	43062 ⁸
	Resorte Trasero		G63355	61525 81039	58355 77355	34036 ⁸		82003	49107 ⁷ 43062 ⁸
67	Todos		G63355	61525 81039	58355 77355	34036 ⁸		G63306	82006	43093 ⁸ 49162 ⁷

VAN 3/4 TON, G / SAVANNA

03-16	Todos			G63897	61687	77638
	Coil(FrontSpringType)		G63895	61685		G63897	61687	77638
03-12	Barra de Torsión (Suspensión de Resorte Delantera)		G63893	61683		G63897	61687	77638
	Barra de Torsion (FrontSpringType)		61683		G63897	61687	77638
96-02	Exc. 8600# GVW			77638
	Exc. PBV 8600 #		G63375 ⁵	61555 81713 ⁵	77375		G63638	61565 81789	58638 77638	43180 ⁸ 49231 ⁷
78-95	Exc. PBV 8600 #		G63357	61517 81108	58357 77357		G63413	61522 81496	58413 77413	49212 ⁷
	Exc. PBV 8600#		G63357	



5 Use el kit 140719 para reemplazar partes del EO de montaje inferior cuando los pernos se rompan o los tornillos autoroscantes no se puedan utilizar más.

8 Paquetes en pares

7 Paquetes en pares; kit de mangueras de aire incluido

84 Amortiguador de repuesto para los vehículos con el kit de montaje aftermarket GRC

AMORTIGUADORES Y STRUTS

Año	Notas de Aplicación	From 					Rear 				
		Ultra	ProGuard\ Guardian	LTV\ Max Control	Protector de Strut\ Bases de Strut	HiJacker\ Soporte\ Hidráulico	Ultra	ProGuard\ Guardian	LTV\ Max Control	Protector de Strut\ Bases de Strut	HiJacker\ Soporte\ Hidráulico

GMC

GMC

VAN 3/4 TON, G / SAVANNA (cont)

71-77	Todos	○	G63357	61517 81108	58357 77357	○	G63306	82006	43093 ⁸ 49162 ⁷
70	Todos	○	○	G63306	82006	43093 ⁸ 49162 ⁷
	Eje Delantero con Viga en I	○	82062	○	G63306	82006	43093 ⁸ 49162 ⁷
	Suspensión Delantera Independiente	○	G63357	61517 81108	58357 77357	○	G63306	82006	43093 ⁸ 49162 ⁷
67-69	Todos	○	82062	○	G63306	82006	43093 ⁸ 49162 ⁷

VAN 3/4 TON, G / SAVANNA ESTABILIZADORES DE DIRECCIÓN

		Delantero		Trasero	
70-95	Estabilizador de Dirección Sistema Sencillo	6802SE ⁸⁴		

VAN 3/4 TON, P SERIES

79-89	Todos	○	G63355	61525 81039	58355 77355	34036 ⁸	○	G63366	61649 81174	58366
73-78	Todos	○	G63355	61525 81039	58355 77355	34036 ⁸	○	G63349	61524 81164	58349 77349	43111 ⁸ 49155 ⁷
68-72	Todos	○	G63355	61525 81039	58355 77355	34036 ⁸	○	G63306	82006	43093 ⁸ 49162 ⁷
67	Todos	○	82047	○

VAN 1 TON, G / SAVANNA



13-16	Todos	○	○	G63897	61687	77638
	Coil(FrontSpringType)	○	G63895	61685	○	G63897	61687	77638
04-12	Todos	○	○	77638
	Barra de Torsión (Suspensión de Resorte Delantera)	○	G63893	○	77638
	Con Rodado Sencillo	○	○	61687	77638
	Rodada Trasera Sencilla	○	○	G63897	77638
	Single Rear Wheels	○	○	G63897	61687	77638
	Coil(FrontSpringType)	○	G63895	61685	○	77638
04-06	Doble Rodada Trasera	○	○	G63898	61688	77638
03	Barra de Torsión (Suspensión de Resorte Delantera)	○	G63893	○
	Con Rodado Sencillo	○	○	61687
	Doble Rodada Trasera	○	○	G63898	61688
	Rodada Trasera Sencilla	○	○	G63897
	Single Rear Wheels	○	○	G63897	61687
	Coil(FrontSpringType)	○	G63895	61685	○
97-02	Todos	○	G63375 ⁵	61555 81713 ⁵	77375	○	81789	43180 ⁸ 49231 ⁷
	Exc. 8600# GVW	○	G63375 ⁵	61555 81713 ⁵	77375	○	81789	77638	43180 ⁸ 49231 ⁷
	Exc. PBV 8600 #	○	G63375 ⁵	61555 81713 ⁵	77375	○	G63638	61565 81789	58638 77638	43180 ⁸ 49231 ⁷
96	Todos	○	G63375 ⁵	61555 81713 ⁵	58357 77375	○	43180 ⁸
	7100, 7400 and 8600# GVW	○	G63375 ⁵	61555 81713 ⁵	58357 77375	○	77638	43180 ⁸
	7100, 7400, y 8600# PBV	○	G63375 ⁵	61555 81713 ⁵	58357 77375	○	77638	43180 ⁸
	Exc. 8600# GVW	○	G63375 ⁵	61555 81713 ⁵	58357 77375	○	77638	43180 ⁸

5 Use el kit 140719 para reemplazar partes del EO de montaje inferior cuando los pernos se rompan o los tornillos autoroscantes no se puedan utilizar más.
8 Paquetes en pares

7 Paquetes en pares; kit de mangueras de aire incluido

84 Amortiguador de repuesto para los vehículos con el kit de montaje aftermarket GRC

AMORTIGUADORES Y STRUTS

Año	Notas de Aplicación										
		Ultra	ProGuard\ Guardian	LTV\ Max Control	Protector de Strut\ Bases de Strut	HiJacker\ Soporte\ Hidráulico	Ultra	ProGuard\ Guardian	LTV\ Max Control	Protector de Strut\ Bases de Strut	HiJacker\ Soporte\ Hidráulico

GMC

GMC

VAN 1 TON, G / SAVANNA (cont)

96	Exc. PBV 8600 #	⊖	G63375 ⁵	61555 81713 ⁵	58357 77375	⊖	G63638	61565	58638 77638	43180 ⁸
	Cutaway Van	⊖	G63375 ⁵	61555 81713 ⁵	58357 77375	⊖	G63671	43180 ⁸
	Cutaway Van PBV 9200	⊖	G63375 ⁵	61555 81713 ⁵	58357 77375	⊖	G63403	43180 ⁸
	Exc. Cutaway Van	⊖	G63375 ⁵	61555 81713 ⁵	58357 77375	⊖	G63413	61522 ⁶ 81496	58413	43180 ⁸
92-95	Cutaway Van	⊖	G63357	61517 81108	58357 77357	⊖	G63671	58403
79-95	Cutaway Van PBV 9200	⊖	G63357	61517 81108	58357 77357	⊖	G63403	77403
	Exc. Cutaway Van	⊖	G63357	61517 81108	58357 77357	⊖	G63413	61522 ⁶ 81496	58413	49212 ⁷
78-95	Todos	⊖	G63357	61517 81108	58357 77357	⊖
79-91	Cutaway Van	⊖	G63357	61517 81108	58357 77357	⊖	58403
78	Cutaway Van	⊖	G63357	61517 81108	58357 77357	⊖	G63413	61522 ⁶ 81496	58413	49212 ⁷
76-77	Todos	⊖	G63357	61517 81108	58357 77357	⊖	G63306	82006	43093 ⁸ 49162 ⁷
75	Todos	⊖	77357	⊖
	110.0(WheelBase)	⊖	61517	58357 77357	⊖	G63306	82006	43093 ⁸ 49162 ⁷
	125.0(WheelBase)	⊖	61517	58357 77357	⊖	G63306	82006	43093 ⁸ 49162 ⁷
	146.0(WheelBase)	⊖	G63357	81108	77357	⊖
71-74	Todos	⊖	G63357	61517 81108	58357 77357	⊖	G63306	82006
	Exc. Base de rueda de 146"	⊖	G63357	61517 81108	58357 77357	⊖	G63306	82006	43093 ⁸ 49162 ⁷

VAN 1 TON, G / SAVANNA ESTABILIZADORES DE DIRECCIÓN

		Delantero	Trasero
94-95	Estabilizador de Dirección Sistema Sencillo HD c/ Eje Delantero Rígido y Tilt Hood	6804SE ⁸⁰
71-95	Estabilizador de Dirección Sistema Sencillo	6802SE ⁸⁴

VAN 1 TON, P SERIES

92-99	Todos	⊖	⊖	G63366	61649 81174	58366 77662
	Chasis Motorhome c/ Eje de Viga Delantero en I	⊖	G63625	⊖	G63366	61649 81174	58366 77662
	Chasis Motorhome c/ Suspensión Delantera Independiente	⊖	G63394	58394	⊖	G63366	61649 81174	58366 77662
91	Todos	⊖	61525 81039	⊖	G63366	61649 81174	58366 77662
	Chasis Motorhome c/ Eje de Viga Delantero en I	⊖	G63625	61525 81039	⊖	G63366	61649 81174	58366 77662
	Chasis Motorhome c/ Suspensión Delantera Independiente	⊖	G63394	61525 81039	58394	⊖	G63366	61649 81174	58366 77662
	5.7L 8Cyl (350) SFI	⊖	81039 61525	⊖	G63366	81174 61649	58366 77662
86-90	Chasis Motorhome c/ Eje de Viga Delantero en I	⊖	G63625	⊖	G63366	61649 81174	58366 77662
85-90	Chasis Motorhome c/ Suspensión Delantera Independiente	⊖	G63394	58394	⊖	G63366	61649 81174	58366 77662
75-90	Todos	⊖	⊖	G63366	61649 81174	58366 77662
	Exc. Chasis Motorhome	⊖	G63355	61525 81039	58355 77355	34036 ⁸	⊖	G63366	61649 81174	58366 77662
85	Chasis Motorhome c/ Eje de Viga Delantero en I	⊖	G63403	58403 77403	⊖	G63366	61649 81174	58366 77662

5 Use el kit 140719 para reemplazar partes del EO de montaje inferior cuando los pernos se rompan o los tornillos autoroscantes no se puedan utilizar más.

7 Paquetes en pares; kit de mangueras de aire incluido

80 No requiere soportes para el montaje, instalar sobre montajes de EO Ve a Ref. C para Botas.

6 Se recomienda que cuando se reemplacen amortiguadores "quad", los 4 sean de la misma serie.

8 Paquetes en pares

84 Amortiguador de repuesto para los vehículos con el kit de montaje aftermarket GRC

AMORTIGUADORES Y STRUTS

Año	Notas de Aplicación	From					Rear				
		Ultra	ProGuard\ Guardian	LTV\ Max Control	Protector de Strut\ Bases de Strut	HiJacker\ Soporte\ Hidráulico	Ultra	ProGuard\ Guardian	LTV\ Max Control	Protector de Strut\ Bases de Strut	HiJacker\ Soporte\ Hidráulico

GMC

GMC

VAN 1 TON, P SERIES (cont)

75-84	Chasis Motorhome	○	G63394	58394	○	G63366	61649 81174	58366 77662
74	Todos	○	○	G63366	61649 81174	58366
	Base, Exc. Chasis Motorhome	○	81039	○	G63366	61649 81174	58366
	Chasis Motorhome	○	G63394	58394	○	G63366	61649 81174	58366
	Exc. Chasis Motorhome	○	G63355	61525	58355 77355	34036 ⁸	○	G63366	61649 81174	77662 58366
73	Todos	○	○	G63366	61649
	Base, Exc. Chasis Motorhome	○	81039	○	G63366	81174 61649	58366
	Exc. Chasis Motorhome	○	G63355	61525	58355 77355	34036 ⁸	○	G63366	61649	77662
68-72	Todos	○	G63355	61525 81039	58355 77355	34036 ⁸	○
	Exc. Eje Trasero 11,000#	○	G63355	61525 81039	58355 77355	34036 ⁸	○	G63306	82006	43093 ⁸ 49162 ⁷
67	Todos	○	82047	○

VAN 1 TON, P SERIES ESTABILIZADORES DE DIRECCIÓN

		Delantero	Trasero
79-93	Step Van Forward Control y Motorhome	6805SE ⁸⁰
75-78	Chasis Motorhome	6805SE ⁸⁰

VAN, PB 1000 SERIES

63-65	Todos	○	G63355	61525 81039	58355 77355	34036 ⁸	○	G63306	82006	43093 ⁸ 49162 ⁷
-------	-------	---	--------	----------------	----------------	------	--------------------	---	--------	-------	------	------	--





YUKON

15	Todos	↓	G51960	↓	G64107
12-14	Todos	○	○	G64101	77975
	Exc. Suspensión Z55 o ZW7	↓	G51891	○	G64101	77975
12-13	Exc. Suspensión Electrónica Ajustable	↓	143316 ⁸³	○	G64101	77975
07-11	Exc. Suspensión Electrónica Ajustable	↓	143316 ⁸³	○
	Exc. Suspensión Z55 o ZW7	↓	G51891	○	G63866	61675 81930	58930 77953
00-06	Todos	↓	↓	49616
	Exc. Suspensión Z55 Auto Ride	↓	G63803	61643 81922	58803 77803	○	G63866	61675 81930	77953	43182 49616
	Exc. Suspensión Z55 o ZW7	↓	○	58930	49616
02	Denali, Exc. Suspensión Z55 Auto Ride	○	○	81930	49616
00	Denali	○	○	G63896	49616
92-99	Todos	○	○	G63896	61565 81789	58638 77638	43180 ⁸ 49231 ⁷
	4WD	○	G63609	61542 81726	58901 77609	○	G63896	61565 81789	58638 77638	43180 ⁸ 49231 ⁷
	RWD	↓	G63489	61544 81668	58489 77489	○	G63896	61565 81789	58638 77638	43180 ⁸ 49231 ⁷
99	Denali	○	61542 81726	58901 77609	○	G63896	61565 81789	58638 77638	43180 ⁸ 49231 ⁷
	Denali, 4WD	○	○	G63896	81789 61565	58638 77638	49231 ⁷ 43180 ⁸

7 Paquetes en pares; kit de mangueras de aire incluido
53 Montaje de Strut. Es probable reutilizar algunas partes del E.O.

8 Paquetes en pares
80 No requiere soportes para el montaje, instalar sobre montajes de EO Veá Ref. C para Botas.

AMORTIGUADORES Y STRUTS

Año	Notas de Aplicación										
			Ultra	ProGuard\ Guardian	LTV\ Max Control	Protector de Strut\ Bases de Strut	HiJacker\ Soporte\ Hidráulico		Ultra	ProGuard\ Guardian	LTV\ Max Control

GMC

GMC







YUKON ESTABILIZADORES DE DIRECCIÓN

		Delantero	Trasero
99-05	4WD	6853SE ⁸²
95-99	RWD	6852SE ⁸²













YUKON READYMOUNTS

		Delantero	Trasero
07-13	Exc. Suspensión Z55 o ZW7	G57125⁴⁰

YUKON XL

15	Todos		G51960		G64107
00-06	Todos			49616
	Exc. Suspensión Z55 Auto Ride			43182 49616









YUKON XL 1/2 TON

12-14	Todos			G64101
	Exc. Suspensión Z55 o ZW7		G51891		G64101
12-13	Exc. Suspensión Z55 Auto Ride		143316 ⁵³		G64101
07-11	Exc. Suspensión Z55 Auto Ride		143316 ⁵³		61675	58930
	Exc. Suspensión Z55 o ZW7		G51891		G63866	77953
00-06	Exc. Suspensión Z55 Auto Ride		G63803	61643 81922	58803 77803		G63866	61675 81930	58930 77953

YUKON XL 1/2 TON READYMOUNTS

		Delantero	Trasero
07-14	Exc. Suspensión Z55 o ZW7	G57125⁴⁰

















YUKON XL 3/4 TON

07-11	Exc. Sistema de Autonivelación NIVOMAT			61675	58930
	Exc. Suspensión Z55 o ZW7			77953
00-06	Exc. Sistema de Autonivelación NIVOMAT		G63817	61663 81925	58817 77817		G63866	61675 81930	58930 77953
	Exc. Suspensión Z55 Auto Ride		81922	

HONDA

HONDA

ACCORD

13-14	Todos			G511003
	Izquierdo		G52428		G511003
	Derecho		G52429		G511003
08-12	Izquierdo		G51877 ³		G51892
	Derecho		G51878 ³		G51892
	Exc. Modelo Hybrid		142230 ⁵³		142230 ⁵³
03-07	Exc. Modelo Hybrid		G51737	142230 ⁵³		G51738	142230 ⁵³
98-02	Todos		G55870	142230 ⁵³		G55871	142230 ⁵³ 142300 ⁶²

3 Número de parte futuro

53 Montaje de Strut. Es probable reutilizar algunas partes del E.O.



82 Use kit si está señalado. Vea Ref. C para Botas.

Texto en Negritas - Número de Parte Nuevo / Futuro

40 Strut ReadyMount. Ensamble Completo

62 Kit de Montaje incluye Buje de Montaje Inferior. Es probable reutilizar algunas partes del E.O.

AMORTIGUADORES Y STRUTS

Año	Notas de Aplicación	From 					Rear 				
		Ultra	ProGuard\ Guardian	LTV\ Max Control	Protector de Strut\ Bases de Strut	HiJacker\ Soporte\ Hidráulico	Ultra	ProGuard\ Guardian	LTV\ Max Control	Protector de Strut\ Bases de Strut	HiJacker\ Soporte\ Hidráulico

HONDA

HONDA

ACCORD (cont)

94-97	Todos	G55877	142230 ⁵³	G55786	142231 ⁵³
90-93	Todos	G55774	142230 ⁵³	G55786	142231 ⁵³
86-89	Todos	G55742	142230 ⁵³	G55743	142231 ⁵³
82-85	Todos	G55515	G55516	142231 ⁵³
79-81	Todos	142231 ⁵³

ACCORD READYMOUNTS

							Delantero	Trasero
03-07	Exc. Modelo Hybrid Izquierdo						G57054 ⁴⁰	G57056 ⁴⁰
	Exc. Modelo Hybrid Derecho						G57055 ⁴⁰	G57056 ⁴⁰
98-02	Izquierdo						G56991 ⁴⁰	G56943 ⁴⁰
	Derecho						G56992 ⁴⁰	G56943 ⁴⁰
94-97	Izquierdo						G56961 ⁴⁰	G56968 ⁴⁰
	Derecho						G56961 ⁴⁰	G56969 ⁴⁰
90-93	Izquierdo						G56981 ⁴⁰	G56968 ⁴⁰
	Derecho						G56981 ⁴⁰	G56969 ⁴⁰

CITY

10-12	Izquierdo	G52152	G51905
	Derecho	G52153	G51905

CIVIC

14-15	Todos	143528
12-13	Izquierdo	G52327	143528	70067	143530 ⁵³
	Derecho	G52328	143528	70067	143530 ⁵³
10-11	Izquierdo	G52327	143497 ⁵³	70067 G51807	143498 ⁵³
	Derecho	G52328	143497 ⁵³	70067 G51807	143498 ⁵³
	Exc. Modelos SI y GX Izquierdo	G52038
	Exc. Modelos SI y GX Derecho	G52039
06-09	Todos	143497 ⁵³	G51807	143498 ⁵³
	Exc. Modelos SI y GX Izquierdo	G52038	143497 ⁵³	G51807	143498 ⁵³
	Exc. Modelos SI y GX Derecho	G52039	143497 ⁵³	G51807	143498 ⁵³
03-05	Todos	G51716	142230 ⁵³
	Coupe y Sedan Models Exc. Hybrid Izquierdo	G56677	G51716	142230 ⁵³
	Coupe y Sedan Models Exc. Hybrid Derecho	G56678	G51716	142230 ⁵³
	Exc. Hatchback Izquierdo	143233 ⁶⁰	G51716	142230 ⁵³



40 Strut ReadyMount. Ensamble Completo

53 Montaje de Strut. Es probable reutilizar algunas partes del E.O.

60 La Base de Strut contiene un Rodamiento de Metal. Es probable reutilizar algunas partes del E.O.

Texto en Negritas - Número de Parte Nuevo / Futuro

AMORTIGUADORES Y STRUTS

Año	Notas de Aplicación	Front					Rear				
			Ultra	ProGuard\ Guardian	LTV\ Max Control	Protector de Strut\ Bases de Strut	HiJacker\ Soporte\ Hidráulico		Ultra	ProGuard\ Guardian	LTV\ Max Control

HONDA

HONDA

CIVIC (cont)

03-05	Exc. Hatchback Derecho	143265 ⁵⁰	G51716	142230 ⁵³
	Hatchback	143353 ⁵³	G51716	142230 ⁵³
	Hybrid, Izquierdo	G56621	G51716	142230 ⁵³
	Hybrid, Derecho	G56622	G51716	142230 ⁵³
02	Todos	G51700	142230 ⁵³
	Exc. Hatchback Izquierdo	G56621	143233 ⁵⁰	G51700	142230 ⁵³
	Exc. Hatchback Derecho	G56622	143265 ⁵⁰	G51700	142230 ⁵³
	Hatchback	143353 ⁵³	G51700	142230 ⁵³
01	Izquierdo	G56621	143353 ⁵³	G51700	142230 ⁵³
	Derecho	G56622	143353 ⁵³	G51700	142230 ⁵³
96-00	Todos	G55909	142230 ⁵³	G55910	142230 ⁵³
92-95	Todos	G55802	142230 ⁵³	G55803	142230 ⁵³ 142300 ⁵²
	Upper Mount orientation may be required	G55802	142230 ⁵³	G55803	142230 ⁵³ 142300 ⁵²
89-91	Todos	142230 ⁵³	142230 ⁵³ 142300 ⁵²
	Hatchback	G55773	142230 ⁵³	G55771	142230 ⁵³ 142300 ⁵²
	Sedan	G55773	142230 ⁵³	G55771	142230 ⁵³ 142300 ⁵²
	Wagon	G55781	142230 ⁵³	G55782	142230 ⁵³ 142300 ⁵²
88	Hatchback	G55763	142230 ⁵³	G55766	142230 ⁵³
	Sedan	G55763	142230 ⁵³	G55766	142230 ⁵³
85-87	Todos	142231 ⁵³
	4WD, Wagon	G55728	142231 ⁵³
84-87	FWD, Wagon	G55732	G51170	142231 ⁵³
	Hatchback	G55725	G51170	142231 ⁵³
	Sedan	G55725	G51170	142231 ⁵³
84	Todos	G51170	142231 ⁵³
80-83	Todos	G55706	142231 ⁵³
	Exc. Wagon	G55706	G55707	142231 ⁵³
	Wagon	G55706	69884	142231 ⁵³
75-79	Wagon	69884	

53 Montaje de Strut. Es probable reutilizar algunas partes del E.O.

62 Kit de Montaje incluye Buje de Montaje Inferior. Es probable reutilizar algunas partes del E.O.

60 La Base de Strut contiene un Rodamiento de Metal. Es probable reutilizar algunas partes del E.O.

AMORTIGUADORES Y STRUTS

Año	Notas de Aplicación	Front					Rear				
		Ultra	ProGuard\ Guardian	LTV\ Max Control	Protector de Strut\ Bases de Strut	HiJacker\ Soporte\ Hidráulico	Ultra	ProGuard\ Guardian	LTV\ Max Control	Protector de Strut\ Bases de Strut	HiJacker\ Soporte\ Hidráulico

HONDA

HONDA

CIVIC DEL SOL

93-97	Todos	G55802	142230 ⁵³	G55803	142230 ⁵³ 142300 ⁶²
	Upper Mount orientation may be required	G55802	142230 ⁵³	G55803	142230 ⁵³ 142300 ⁶²

CIVIC READYMOUNTS

							Delantero	Trasero
03-05	Izquierdo						G57061 ⁴⁰
	Derecho						G57062 ⁴⁰
01-05	Exc. Hatchback Izquierdo						G57049 ⁴⁰
	Exc. Hatchback Derecho						G57050 ⁴⁰
02-04	Hatchback; Exc. Modelos Hybrid y SI Izquierdo						G57028 ⁴⁰
	Hatchback; Exc. Modelos Hybrid y SI Derecho						G57029 ⁴⁰
01-02	Izquierdo						G57032 ⁴⁰
	Derecho						G57033 ⁴⁰
96-00	Izquierdo						G56996 ⁴⁰	G56998 ⁴⁰
	Derecho						G56997 ⁴⁰	G56998 ⁴⁰
92-95	Izquierdo						G56993 ⁴⁰	G56995 ⁴⁰
	Derecho						G56994 ⁴⁰	G56995 ⁴⁰

CR-V

13-14	Izquierdo	G52187	G51972
	Derecho	G52188	G51972
12	Izquierdo	G52187	142230 ⁵³
	Derecho	G52188	142230 ⁵³
07-11	Izquierdo	G52187	G51879	142230 ⁵³
	Derecho	G52188	G51879	142230 ⁵³
03-06	Izquierdo	G56800	143353 ⁵³	G51286	142230 ⁵³
	Derecho	G56799	143353 ⁵³	G51286	142230 ⁵³
02	Izquierdo	G56800	143353 ⁵³	G51286
	Derecho	G56799	143353 ⁵³	G51286
97-01	Todos	G51255	142230 ⁵³	G51256	142230 ⁵³

CR-V READYMOUNTS

							Delantero	Trasero
02-06	Izquierdo						G57086 ⁴⁰
	Derecho						G57087 ⁴⁰
	Automatic Izquierdo						G57084 ⁴⁰
	Automatic Derecho						G57085 ⁴⁰
97-01	Izquierdo						G57116 ⁴⁰	G57104 ⁴⁰
	Derecho						G57117 ⁴⁰	G57104 ⁴⁰

CR-Z

11-14	Todos	G511037
-------	-------	------	------	------	------	------	---------	------	------	------	------

40 Strut ReadyMount. Ensamble Completo

53 Montaje de Strut. Es probable reutilizar algunas partes del E.O.

62 Kit de Montaje incluye Bujes de Montaje Inferior. Es probable reutilizar algunas partes del E.O.

Texto en Negritas - Número de Parte Nuevo / Futuro

AMORTIGUADORES Y STRUTS

Año	Notas de Aplicación	Front					Rear				
		Ultra	ProGuard\ Guardian	LTV\ Max Control	Protector de Strut\ Bases de Strut	HiJacker\ Soporte\ Hidráulico	Ultra	ProGuard\ Guardian	LTV\ Max Control	Protector de Strut\ Bases de Strut	HiJacker\ Soporte\ Hidráulico

HONDA

HONDA

CRX

89-91	Todos	G55787	142230 ⁵³	G55803	142230 ⁵³
88	Todos	G55763	142230 ⁵³	G55766	142230 ⁵³

ELEMENT

07-11	Izquierdo	G52507	G51858	142230 ⁵³
	Derecho	G52508	G51858	142230 ⁵³
03-06	Todos	143353 ⁵³	G51858	142230 ⁵³
	Exc. Modelo SC Izquierdo	G52112	143353 ⁵³	G51858	142230 ⁵³
	Exc. Modelo SC Derecho	G52113	143353 ⁵³	G51858	142230 ⁵³

FIT

15-16	Exc. Modelo EV Izquierdo	G52152
	Exc. Modelo EV Derecho	G52153
10-14	Exc. Modelo EV Izquierdo	G52152	G51905
	Exc. Modelo EV Derecho	G52153	G51905
09	Modelo Americano	G51905
	Exc. Modelo EV Izquierdo	G52152
	Exc. Modelo EV Derecho	G52153
07-08	Izquierdo	G52282	70060 G511062
	Derecho	G52283	70060 G511062
06-08	Todos	G511062
06	Izquierdo	G52588	G511062
	Derecho	G52589	G511062

ODYSSEY

12-17	Todos	G64154
	From Chassis/VIN CB088499	143305	G64154
11-17	Izquierdo	G52665	G64154
	Derecho	G52666	G64154
08-10	Izquierdo	G52253	143305	70010
	Derecho	G52254	143305	70010
05-10	Todos	143305	70010
	Kit w/ Mount and Bearing	143305	70010

53 Montaje de Strut. Es probable reutilizar algunas partes del E.O.

AMORTIGUADORES Y STRUTS

Año	Notas de Aplicación	From					Rear				
		Ultra	ProGuard\ Guardian	LTV\ Max Control	Protector de Strut\ Bases de Strut	HiJacker\ Soporte\ Hidráulico	Ultra	ProGuard\ Guardian	LTV\ Max Control	Protector de Strut\ Bases de Strut	HiJacker\ Soporte\ Hidráulico

HONDA

HONDA

ODYSSEY (cont)

05-07	Izquierdo	↓	G52030	143305	...	↓	70010
	Derecho	↓	G52031	143305	...	↓	70010
99-04	Izquierdo	↓	G56559	143315 ⁵³	...	↓	69909 G63877
	Derecho	↓	G56558	143315 ⁵³	...	↓	69909 G63877
95-98	Todos	↓	G55877	142230 ⁵³	...	↓	G55821	142230 ⁵³	...

ODYSSEY READYMOUNTS

		Delantero		Trasero	
05-07	Izquierdo	G57137⁴⁰		...	
	Derecho	G57138⁴⁰		...	
99-04	Izquierdo	G57011⁴⁰		...	
	Derecho	G57012⁴⁰		...	

PASSPORT

98-02	Todos	↓	G63611	61593 81872	↓	G63710	61610 81911
94-97	Todos	↓	G63611	61593 81872	↓	G63610	61592 81937

PILOT

09-12	Izquierdo	↓	G52360	↓	
	Derecho	↓	G52361	↓	
03-08	Izquierdo	↓	G56759	143315 ⁵³	...	↓	G64003	61704
	Derecho	↓	G56758	143315 ⁵³	...	↓	G64003	61704

PILOT READYMOUNTS

		Delantero		Trasero	
03-08	AWD, Derecho	G57120⁴⁰		...	
08	AWD, Izquierdo	G57119⁴⁰		...	
07	AWD, Izquierdo	G57119⁴		...	
03-06	AWD, Izquierdo	G57119⁴⁰		...	

PRELUDE

97-01	Todos	↓	G51264	142230 ⁵³	...	↓	G55805	142231 ⁵³	...
92-96	Todos	↓	G55795	142230 ⁵³	...	↓	G55805	142231 ⁵³	...
88-91	Todos	↓	G55742	142230 ⁵³	...	↓	G55757
83-87	Todos	↓	142230 ⁵³	...	↓	142231 ⁵³	...
	Struts Traseros Sellados	↓	142230 ⁵³	...	↓	G55516	142231 ⁵³	...
79-82	Todos	↓	↓	142231 ⁵³	...

RIDGELINE

12	Todos	↓	↓	142230 ⁵³	...
11	Izquierdo	↓	G52150	↓	142230 ⁵³	...





4 Número de futuro, las cantidades disponibles Q4 2016.

40 Strut ReadyMount. Ensemble Completo

53 Montaje de Strut. Es probable reutilizar algunas partes del E.O.

Texto en Negritas - Número de Parte Nuevo / Futuro







AMORTIGUADORES Y STRUTS

Año	Notas de Aplicación										
			Ultra	ProGuard\ Guardian	LTV\ Max Control	Protector de Strut\ Bases de Strut	HiJacker\ Soporte\ Hidráulico		Ultra	ProGuard\ Guardian	LTV\ Max Control





HONDA

HONDA

RIDGELINE (cont)

11	Derecho		G52151		142230 ⁵³
06-10	Izquierdo		G52150		G51880	142230 ⁵³
	Derecho		G52151		G51880	142230 ⁵³



S2000

08-09	Todos			142230 ⁵³
00-07	Todos		142230 ⁵³		142230 ⁵³











HUMMER

HUMMER

H2

03-07	Todos		G63817	61663	77817		61701
	Todos		G63817	61663	77817		G64000	61701



























H3

09-10	Todos		G64001		G63965
	w/Off Road Package		G64001		G63965	77983
06-08	Todos		61702		61695
	Todos		G64001	61702		G63965	61695
	w/Off Road Package		61702		61695	77983

HYUNDAI

HYUNDAI

ACCENT

14-16	Izquierdo		G52353		70095
	Derecho		G52354		70095
06-11	Izquierdo		G52154	143409		70036	142419 ⁵³ 143411
	Derecho		G52155	143410		70036	142419 ⁵³ 143411
00-05	Todos		G56522	142935 ⁵³		142626 ⁵³
	Izquierdo Gas Charged Unit		G56522	142935 ⁵³		G52333	142626 ⁵³
	Izquierdo Non-Gas Charged Unit		G56522	142935 ⁵³		G56524 ⁴⁴	142626 ⁵³
	Derecho Gas Charged Unit		G56522	142935 ⁵³		G52334	142626 ⁵³
	Derecho Non-Gas Charged Unit		G56522	142935 ⁵³		G56523 ⁴⁴	142626 ⁵³
97-99	Todos		G55849		142626 ⁵³
	Fab. desde 6/97; Non Gas Charged Unit		G55849		G55890	142626 ⁵³
97	Fab. hasta 6/97		G55849		G55850	142626 ⁵³
95-96	Todos		G55849		G55850	142626 ⁵³

44 Este strut no está presurizado por lo que el vástago no se extenderá por sí solo.

53 Montaje de Strut. Es probable reutilizar algunas partes del E.O.

AMORTIGUADORES Y STRUTS

Año	Notas de Aplicación	Front					Rear				
		Ultra	ProGuard\ Guardian	LTV\ Max Control	Protector de Strut\ Bases de Strut	HiJacker\ Soporte\ Hidráulico	Ultra	ProGuard\ Guardian	LTV\ Max Control	Protector de Strut\ Bases de Strut	HiJacker\ Soporte\ Hidráulico

HYUNDAI

HYUNDAI

AZERA

15	Izquierdo	G52437
	Derecho	G52438
12-14	Izquierdo	G52437	70068
	Derecho	G52438	70068
11	Todos	143342 ⁵³	70013
06-10	Todos	G51806	143342 ⁵³	70013	143386 ⁵³

ELANTRA

12-13	Exc. Ruedas de 16 y 17"	70098
	Izquierdo	G52439
	Derecho	G52440
11	Todos	143477 ⁵³
	Exc. Ruedas de 16 y 17"	143477 ⁵³	70098
07-10	Izquierdo	G52156	143477 ⁵³	70037
	Derecho	G52157	143477 ⁵³	70037
01-06	Izquierdo	G56539	142625 ⁵³	G56640	142535 ⁵³
	Derecho	G56540	142625 ⁵³	G56641	142536 ⁵³
00	Todos	142625 ⁵³
	Fab. hasta 5/00	G56525	142625 ⁵³
	Izquierdo	142625 ⁵³	142535 ⁵³
	Izquierdo Fab. desde 5/00	G56539	142625 ⁵³	G56640
	Izquierdo Fab. hasta 5/00	G56526	142625 ⁵³
	Izquierdo Fab. hasta 5/00; Non-Gas Charged Unit	142625 ⁵³	G56528 ⁴⁴
	Derecho	142625 ⁵³	142536 ⁵³
	Derecho Fab. desde 5/00	G56540	142625 ⁵³	G56641
Derecho Fab. hasta 5/00; Non-Gas Charged Unit	142625 ⁵³	G56527 ⁴⁴	
96-99	Todos	G56525	142625 ⁵³
	Izquierdo	G56526	142625 ⁵³	142535 ⁵³
	Izquierdo Gas Charged Unit	G56525	142625 ⁵³	G52335
	Izquierdo Non-Gas Charged Unit	G56525	142625 ⁵³	G56528 ⁴⁴

44 Este strut no está presurizado por lo que el vástago no se extenderá por sí solo. 53 Montaje de Strut. Es probable reutilizar algunas partes del E.O.

Texto en Negritas - Número de Parte Nuevo / Futuro

AMORTIGUADORES Y STRUTS

Año	Notas de Aplicación	Front					Rear				
		Ultra	ProGuard\ Guardian	LTV\ Max Control	Protector de Strut\ Bases de Strut	HiJacker\ Soporte\ Hidráulico	Ultra	ProGuard\ Guardian	LTV\ Max Control	Protector de Strut\ Bases de Strut	HiJacker\ Soporte\ Hidráulico

HYUNDAI

HYUNDAI

ELANTRA (cont)

96-99	Derecho	G56525	142625 ⁵³	142536 ⁵³
	Derecho Gas Charged Unit	G56525	142625 ⁵³	G52336
	Derecho Non-Gas Charged Unit	G56525	142625 ⁵³	G56527 ⁴⁴
92-95	Non-ABS	G55592	G51249	142419 ⁵³

ELANTRA COUPE

13	Exc. Ruedas de 16 y 17"	70098
	Izquierdo	G52439
	Derecho	G52440

ELANTRA READYMOUNTS

		Delantero		Trasero	
00-06	Izquierdo
	Derecho	G57167 ⁴⁰
	Automatic Izquierdo	G57088 ⁴⁰
	Automatic Derecho	G57089 ⁴⁰

ENTOURAGE

09	Todos	143416 ⁵³
07-08	Izquierdo	G52257	143416 ⁵³	G64071
	Derecho	G52258	143416 ⁵³	G64071

EXCEL

90-94	Todos	G55586	69689	81464
86-89	Todos	69689	81464
	Struts Delanteros Reconstruibles de EO	G44944 ⁹⁸	69689	81464

I10

12-14	Izquierdo	G52855	70118
	Derecho	G52856	70118

PONY

84-87	Todos	69689	81464
-------	-------	------	------	------	------	------	-------	-------	------	------

SANTA FE

13-16	AWD	G64144
	Sport, FWD	G64143
10-11	Todos	143416 ⁵⁴
07-09	Izquierdo	G52158	143416 143416 ⁵⁴	G64048

40 Strut ReadyMount. Ensemble Completo

53 Montaje de Strut. Es probable reutilizar algunas partes del E.O.

98 Nota: El nivel de dificultad para instalar este producto es moderadamente alto. Por favor revise las instrucciones cuidadosamente antes de comenzar.

Texto en Negritas - Número de Parte Nuevo / Futuro

44 Este strut no está presurizado por lo que el vástago no se extenderá por sí solo.

54 Kit con Montaje y Rodamiento. Es probable que reutilizar algunas partes del E.O.

AMORTIGUADORES Y STRUTS

Año	Notas de Aplicación	From					Rear				
		Ultra	ProGuard\ Guardian	LTV\ Max Control	Protector de Strut\ Bases de Strut	HiJacker\ Soporte\ Hidráulico	Ultra	ProGuard\ Guardian	LTV\ Max Control	Protector de Strut\ Bases de Strut	HiJacker\ Soporte\ Hidráulico

HYUNDAI

HYUNDAI

SANTA FE (cont)

07-09	Derecho	G52159	143416 143416⁵⁴	...	G64048
05-06	Izquierdo	G56562	69907 G51705
	Derecho	G56561	69907 G51705
01-04	Izquierdo	G56562	143087 ⁵³	...	69907 G51705
	Derecho	G56561	143087 ⁵³	...	69907 G51705

SANTA FE READYMOUNTS

		Delantero	Trasero
01-06	Izquierdo	G57139⁴⁰	...
	Derecho	G57140⁴⁰	...

SCOUPE

91-95	Todos	G55586	69689	81464
-------	-------	--------	-----	-----	-----	-----	-------	-------	-----	-----	-----

SONATA

11-14	Todos	143532	...	70068	143533	...
11	Fab. hasta 7/22/10 Exc. Hybrid Izquierdo	G52329	143532	...	70068	143533	...
	Fab. hasta 7/22/10 Exc. Hybrid Derecho	G52330	143532	...	70068	143533	...
06-10	Todos	G51806	143342 ⁵³	...	70013	143386⁵³	...
01-05	Todos	G51714	142419 ⁵³	...	G51713	142419 ⁵³	...
00	Todos	G56565	142419 ⁵³	142419 ⁵³	...
	Fab. desde 4/00	G56565	142419 ⁵³	...	G51713	142419 ⁵³	...
	Fab. desde 8/00	G51714	142419 ⁵³	142419 ⁵³	...
	Fab. hasta 4/00	G56565	142419 ⁵³	...	G56566	142419 ⁵³	...
99	Todos	G56565	G56566
95-98	Todos	G56577	G51290
89-94	Todos	G51186

SONATA READYMOUNTS

		Delantero	Trasero
00-05	Izquierdo	G57059⁴⁰	G57090⁴⁰
	Derecho	G57059⁴⁰	G57091⁴⁰

TIBURON

03-08	Izquierdo	G56642	143397⁵³	...	G56644	142535 ⁵³	...
	Derecho	G56643	143397⁵³	...	G56645	142536 ⁵³	...
97-01	Todos	G56525	142625 ⁵³
	Izquierdo	G56526	142625 ⁵³	142535 ⁵³	...



40 Strut ReadyMount. Ensamble Completo

53 Montaje de Strut. Es probable reutilizar algunas partes del E.O.

54 Kit con Montaje y Rodamiento. Es probable que reutilizar algunas partes del E.O.

Texto en Negritas - Número de Parte Nuevo / Futuro







AMORTIGUADORES Y STRUTS

Año	Notas de Aplicación	Front					Rear				
			ProGuard\ Guardian	LTV\ Max Control	Protector de Strut\ Bases de Strut	HiJacker\ Soporte\ Hidráulico		ProGuard\ Guardian	LTV\ Max Control	Protector de Strut\ Bases de Strut	HiJacker\ Soporte\ Hidráulico









HYUNDAI

HYUNDAI





TIBURON (cont)

97-01	Izquierdo Non-Gas Charged Unit		G56525	142625 ⁵³		G56528 ⁴⁴
	Derecho		G56525	142625 ⁵³		142536 ⁵³
	Derecho Non-Gas Charged Unit		G56525	142625 ⁵³		G56527 ⁴⁴



TUCSON

11-12	Izquierdo			142535 ⁵³
	Derecho			142536 ⁵³
05-10	Izquierdo		G56819	143087 ⁵³		G56822	142535 ⁵³
	Derecho		G56820	143087 ⁵³		G56821	142536 ⁵³



VERACRUZ

12	Todos			G64048
07-11	Todos		143416 ⁵³		G64048

XG300

01	Todos		G51899		G51713	142419 ⁵³
----	-------	--	--------	------	------	------	------	--	--------	------	------	----------------------	------





XG350

02-05	Todos		G51899		G51713	142419 ⁵³
-------	-------	---	--------	------	------	------	------	---	--------	------	------	----------------------	------





INFINITI

INFINITI





FX35

03-08	Izquierdo		G52061	142937		G51831
	Derecho		G52062	142937		G51831











FX45

03-08	Izquierdo		G52061	142937		G51831
	Derecho		G52062	142937		G51831

G20

91-96	Izquierdo		G56591		G56512
	Derecho		G56591		G56513

G35



08	AWD, Izquierdo Exc. 4 Wheel Steer		G511019		G511021
	AWD, Derecho Exc. 4 Wheel Steer		G511020		G511021
03-07	Todos		143455 ⁵³	
	Coupe Izquierdo Suspensión Deportiva		G51813	143455 ⁵³	
	Coupe Derecho Suspensión Deportiva		G51814	143455 ⁵³	

44 Este strut no está presurizado por lo que el vástago no se extenderá por sí solo.

53 Montaje de Strut. Es probable reutilizar algunas partes del E.O.

Texto en Negritas - Número de Parte Nuevo / Futuro

AMORTIGUADORES Y STRUTS

Año	Notas de Aplicación	From 					Rear 				
		Ultra	ProGuard\ Guardian	LTV\ Max Control	Protector de Strut\ Bases de Strut	HiJacker\ Soporte\ Hidráulico	Ultra	ProGuard\ Guardian	LTV\ Max Control	Protector de Strut\ Bases de Strut	HiJacker\ Soporte\ Hidráulico

INFINITI

INFINITI

G35 (cont)

07	AWD, Izquierdo Exc. 4 Wheel Steer	G511019	143455 ⁵³	G511021
	AWD, Derecho Exc. 4 Wheel Steer	G511020	143455 ⁵³	G511021
05-06	AWD, Izquierdo	G51979	143455 ⁵³
	AWD, Derecho	G51981	143455 ⁵³
03-06	Exc. Suspensión Deportiva	143455 ⁵³	G51764
	Coupe Suspensión Deportiva	143455 ⁵³	G51812

G37

09-10	AWD, Izquierdo Exc. 4 Wheel Steer	G511019	G511021
	AWD, Derecho Exc. 4 Wheel Steer	G511020	G511021

I30

00-01	Todos	142937 ⁵³	G51727
	Kit w/ Mount and Bearing	142937 142937 ⁵³	G51727
	Izquierdo	G56683	142937 ⁵³	G51727
	Derecho	G56684	142937 ⁵³	G51727
96-99	Izquierdo	G55913	142546 ⁵⁴	G51087
	Derecho	G55912	142546 ⁵⁴	G51087

I30 READYMOUNTS

		Delantero	Trasero
96-99	Izquierdo	G56970 ⁴⁰	G57057 ⁴⁰
	Derecho	G56971 ⁴⁰	G57058 ⁴⁰

I35

02-04	Todos	142937 ⁵³	G51727
	Kit w/ Mount and Bearing	142937 142937 ⁵³	G51727
	Izquierdo	G56685	142937 ⁵³	G51727
	Derecho	G56686	142937 ⁵³	G51727

M35

08-10	Todos	G51927
06-07	Izquierdo	G51925	143455 ⁵³	G51927
	Derecho	G51926	143455 ⁵³	G51927

M45

08-10	Todos	G51927
-------	-------	------	------	------	------	------	--------	------	------	------	------

40 Strut ReadyMount. Ensemble Completo

53 Montaje de Strut. Es probable reutilizar algunas partes del E.O.

54 Kit con Montaje y Rodamiento. Es probable que reutilizar algunas partes del E.O.

Texto en Negritas - Número de Parte Nuevo / Futuro

AMORTIGUADORES Y STRUTS

Año	Notas de Aplicación										
		Ultra	ProGuard\ Guardian	LTV\ Max Control	Protector de Strut\ Bases de Strut	HiJacker\ Soporte\ Hidráulico	Ultra	ProGuard\ Guardian	LTV\ Max Control	Protector de Strut\ Bases de Strut	HiJacker\ Soporte\ Hidráulico

INFINITI

INFINITI

M45 (cont)

06-07	Izquierdo	☛	G51925	☛	G51927
	Derecho	☛	G51926	☛	G51927

Q45

02-05	Exc. Suspensión Activa	☛	143210 ⁵³	☛
97-01	Todos	☛	☛	G51930
	Exc. Suspensión Activa	☛	143210 ⁵³	☛	G51930

QX4

02-03	Fab. desde 12/98	☛	142938 ⁵³	☛	G63845
	Izquierdo	☛	G56687	142938 ⁵³	☛
	Derecho	☛	G56688	142938 ⁵³	☛
98-03	Todos	☛	142938 ⁵³	☛
00-01	Izquierdo Fab. desde 12/98	☛	G56615	142938 ⁵³	☛	G63845
	Derecho Fab. desde 12/98	☛	G56616	142938 ⁵³	☛	G63845
99	Fab. desde 12/98	☛	142938 ⁵³	☛	G63845
	Fab. hasta 12/98	☛	142938 ⁵³	☛	61609
	Izquierdo Fab. desde 12/98	☛	G56615	142938 ⁵³	☛
	Izquierdo Fab. hasta 12/98	☛	G56739	142938 ⁵³	☛
	Derecho Fab. desde 12/98	☛	G56616	142938 ⁵³	☛
	Derecho Fab. hasta 12/98	☛	G56736	142938 ⁵³	☛
98	Izquierdo Fab. hasta 12/98	☛	G56739	142938 ⁵³	☛	G63712	61609 81910
	Derecho Fab. hasta 12/98	☛	G56736	142938 ⁵³	☛	G63712	61609 81910
97	Todos	☛	142938 ⁵³	☛	G63712	81910
	Fab. hasta 12/98	☛	142938 ⁵³	☛	G63712	61609 81910
	Izquierdo	☛	G56739	142938 ⁵³	☛	G63712	81910
	Derecho	☛	G56736	142938 ⁵³	☛	G63712	81910

QX4 READYMOUNTS

		Delantero	Trasero
02-03	Izquierdo	G57144 ⁴⁰
	Derecho	G57145 ⁴⁰
99	Fab. hasta 11/98 Izquierdo	G57037 ⁴⁰
	Fab. hasta 11/98 Derecho	G57038 ⁴⁰
98	Fabricado antes de Nov/98 Izquierdo	G57037 ⁴⁰
	Fabricado antes de Nov/98 Derecho	G57038 ⁴⁰
97	Fab. hasta 11/98 Izquierdo	G57037 ⁴⁰

40 Strut ReadyMount. Ensemble Completo

53 Montaje de Strut. Es probable reutilizar algunas partes del E.O.

Texto en Negritas - Número de Parte Nuevo / Futuro

AMORTIGUADORES Y STRUTS

Año	Notas de Aplicación	Front					Rear				
		Ultra	ProGuard\ Guardian	LTV\ Max Control	Protector de Strut\ Bases de Strut	HiJacker\ Soporte\ Hidráulico	Ultra	ProGuard\ Guardian	LTV\ Max Control	Protector de Strut\ Bases de Strut	HiJacker\ Soporte\ Hidráulico

INFINITI

INFINITI

QX4 READYMOUNTS (cont)

		Delantero	Trasero
97	Fab. hasta 11/98 Derecho	G57038 ⁸⁰

QX56

08-10	Todos	G51715	143358 ⁵³ 143359 ⁷⁰
05-07	Todos	G51715	143358 ⁵³ 143359 ⁷⁰	G63875
04	Todos	G51715	143358 ⁵³ 143359 ⁷⁰

QX56 READYMOUNTS

		Delantero	Trasero
04-10	4WD	G57092 ⁸

INTERNATIONAL

INTERNATIONAL

100

74	Todos	G63875	82030
----	-------	------	------	------	------	------	--------	-------	------	------	------

100 ESTABILIZADORES DE DIRECCIÓN

		Delantero	Trasero
74	Todos	6802SE ⁸⁴

150

75	RWD	G63875	82030
----	-----	------	------	------	------	------	--------	-------	------	------	------

150 ESTABILIZADORES DE DIRECCIÓN

		Delantero	Trasero
75	Todos	6802SE ⁸⁴

200

74-75	Todos	G63875	82030	G63875	82030
-------	-------	--------	-------	------	------	------	--------	-------	------	------	------

200 ESTABILIZADORES DE DIRECCIÓN

		Delantero	Trasero
74-75	Todos	6802SE ⁸⁴

908C

68	Todos	G63405	82007	G63405	61500 81147	77405	43048 ⁸ 49310 ⁷
----	-------	--------	-------	------	------	------	--------	----------------	-------	------	--

908C ESTABILIZADORES DE DIRECCIÓN

		Delantero	Trasero
68-69	Estabilizador de Dirección Sistema Sencillo 1/2 Ton, 3/4 Ton y Travelall	6802SE ⁸⁴

1000C

68	Todos	G63405	82049	G63405	61500 81147	43048 ⁸ 49310 ⁷
	Exc. Travelette c/ base de rueda de 166"	G63405	82049	G63405	61500 81147	77405	43048 ⁸ 49310 ⁷

1000C ESTABILIZADORES DE DIRECCIÓN

		Delantero	Trasero
68	Estabilizador de Dirección Sistema Sencillo 1/2 Ton, 3/4 Ton y Travelall	6802SE ⁸⁴

1000D

69-70	Antes de Chasis #H-205000	G63405	82049	G63405	82030
-------	---------------------------	--------	-------	------	------	------	--------	-------	------	------	------

1000D ESTABILIZADORES DE DIRECCIÓN

		Delantero	Trasero
69-70	Estabilizador de Dirección Sistema Sencillo 1/2 Ton, 3/4 Ton y Travelall	6802SE ⁸⁴

3 Número de parte futuro

8 Paquetes en pares

53 Montaje de Strut. Es probable reutilizar algunas partes del E.O.

84 Amortiguador de repuesto para los vehículos con el kit de montaje aftermarket

GRC



Texto en Negritas - Número de Parte Nuevo / Futuro

7 Paquetes en pares; kit de mangueras de aire incluido

40 Strut ReadyMount. Ensemble Completo





70 Kit Buje y Camisa. Algunos accesorios del Equipo Original podrían ser necesitados

AMORTIGUADORES Y STRUTS

Año	Notas de Aplicación	Front					Rear				
			Ultra	ProGuard\ Guardian	LTV\ Max Control	Protector de Strut\ Bases de Strut	HiJacker\ Soporte\ Hidráulico		Ultra	ProGuard\ Guardian	LTV\ Max Control

INTERNATIONAL





1010

71-73	Todos		82049	
71-72	Antes de Chasis #H-205000		82049		82030

1010 ESTABILIZADORES DE DIRECCIÓN

71-73	Estabilizador de Dirección Sistema Sencillo 1/2 Ton, 3/4 Ton y Travelall	Delantero	Trasero
		6802SE ⁸⁴



1100C

68	Todos		82007	
	Exc. Travelette c/ base de rueda de 166"		G63405	61500 81147 82007	77405		G63405	61500 81147	77405 43048 ⁸ 49310 ⁷

1100C ESTABILIZADORES DE DIRECCIÓN

68	Estabilizador de Dirección Sistema Sencillo 1/2 Ton, 3/4 Ton y Travelall	Delantero	Trasero
		6802SE ⁸⁴



1100D

69-70	Todos		82030		82030
-------	-------	---	------	-------	------	------	------	---	------	-------	------	------

1100D ESTABILIZADORES DE DIRECCIÓN

69-70	Estabilizador de Dirección Sistema Sencillo 1/2 Ton, 3/4 Ton y Travelall	Delantero	Trasero
		6802SE ⁸⁴



1110

71-73	Todos		82030		82030
-------	-------	--	------	-------	------	------	------	--	------	-------	------	------

1110 ESTABILIZADORES DE DIRECCIÓN

71-73	Estabilizador de Dirección Sistema Sencillo 1/2 Ton, 3/4 Ton y Travelall	Delantero	Trasero
		6802SE ⁸⁴



1200C

68	Exc. Travelette c/ base de rueda de 166"		G63405	61500 81147 82007	77405		G63405	61500 81147	77405 43048 ⁸ 49310 ⁷
----	--	---	--------	-------------------------	-------	------	------	---	--------	----------------	-------	--

1200C ESTABILIZADORES DE DIRECCIÓN

68	Estabilizador de Dirección Sistema Sencillo 1/2 Ton, 3/4 Ton y Travelall	Delantero	Trasero
		6802SE ⁸⁴



1200D

69-70	Todos		82030		82030
-------	-------	---	------	-------	------	------	------	---	------	-------	------	------

1200D ESTABILIZADORES DE DIRECCIÓN

69-70	Estabilizador de Dirección Sistema Sencillo 1/2 Ton, 3/4 Ton y Travelall	Delantero	Trasero
		6802SE ⁸⁴



1210

71-73	Todos		82030		82030
-------	-------	---	------	-------	------	------	------	---	------	-------	------	------

1210 ESTABILIZADORES DE DIRECCIÓN

71-73	Estabilizador de Dirección Sistema Sencillo 1/2 Ton, 3/4 Ton y Travelall	Delantero	Trasero
		6802SE ⁸⁴



1300C

68	Exc. Travelette c/ base de rueda de 166"		G63405	61500 81147 82007	77405		G63405	61500 81147	77405 43048 ⁸ 49310 ⁷
----	--	---	--------	-------------------------	-------	------	------	---	--------	----------------	-------	--

1300C ESTABILIZADORES DE DIRECCIÓN

68	Estabilizador de Dirección Sistema Sencillo 1/2 Ton, 3/4 Ton y Travelall	Delantero	Trasero
		6802SE ⁸⁴

1300D

69-70	Todos		82030		82030
-------	-------	---	------	-------	------	------	------	---	------	-------	------	------

1300D ESTABILIZADORES DE DIRECCIÓN

69-70	Estabilizador de Dirección Sistema Sencillo 1/2 Ton, 3/4 Ton y Travelall	Delantero	Trasero
		6802SE ⁸⁴

7 Paquetes en pares; kit de mangueras de aire incluido

8 Paquetes en pares

84 Amortiguador de repuesto para los vehículos con el kit de montaje aftermarket GRC

AMORTIGUADORES Y STRUTS

Año	Notas de Aplicación	From					New				
		Ultra	ProGuard\ Guardian	LTV\ Max Control	Protector de Strut\ Bases de Strut	HiJacker\ Soporte\ Hidráulico	Ultra	ProGuard\ Guardian	LTV\ Max Control	Protector de Strut\ Bases de Strut	HiJacker\ Soporte\ Hidráulico

INTERNATIONAL 1310

71-73	Todos	<input type="radio"/>	82030	<input type="radio"/>	82030
-------	-------	-----------------------	-------	-------	-------	-------	-------	-----------------------	-------	-------	-------	-------	-------

1310 ESTABILIZADORES DE DIRECCIÓN

71-73	Estabilizador de Dirección Sistema Sencillo 1/2 Ton, 3/4 Ton y Travelall									Delantero	Trasero		
-------	--	--	--	--	--	--	--	--	--	-----------	---------	--	--

M800 ESTABILIZADORES DE DIRECCIÓN

68-71	Estabilizador de Dirección Sistema Sencillo 1/2 y 3/4 Ton c/ Eje de Viga en I									Delantero	Trasero		
-------	---	--	--	--	--	--	--	--	--	-----------	---------	--	--

M1100 / M1200

68-72	Todos	<input type="radio"/>	81318 82007	<input type="radio"/>	G63405	61500 81147	77405	43048 ⁸ 49310 ⁷
-------	-------	-----------------------	-------	----------------	-------	-------	-------	-----------------------	--------	----------------	-------	-------	--

M1100 / M1200 ESTABILIZADORES DE DIRECCIÓN

68-72	Estabilizador de Dirección Sistema Sencillo 1/2 y 3/4 Ton c/ Eje de Viga en I									Delantero	Trasero		
-------	---	--	--	--	--	--	--	--	--	-----------	---------	--	--

M1400

69	Todos	<input type="radio"/>	82007	<input type="radio"/>	G63405	61500 81147	77405	43048 ⁸ 49310 ⁷
----	-------	-----------------------	-------	-------	-------	-------	-------	-----------------------	--------	----------------	-------	-------	--

M1400 ESTABILIZADORES DE DIRECCIÓN

69	Estabilizador de Dirección Sistema Sencillo 1/2 y 3/4 Ton c/ Eje de Viga en I									Delantero	Trasero		
----	---	--	--	--	--	--	--	--	--	-----------	---------	--	--

SCOUT

61-71	Todos	<input type="radio"/>	82007	<input type="radio"/>	82039
-------	-------	-----------------------	-------	-------	-------	-------	-------	-----------------------	-------	-------	-------	-------	-------

SCOUT ESTABILIZADORES DE DIRECCIÓN

69-71	Estabilizador de Dirección Sistema Sencillo									Delantero	Trasero		
-------	---	--	--	--	--	--	--	--	--	-----------	---------	--	--

61-68	Estabilizador de Dirección Sistema Sencillo 4WD; Scout 80, 800									6802SE ⁸⁴		
-------	--	--	--	--	--	--	--	--	--	----------------------	-------	--	--

SCOUT II

71-80	Todos	<input type="radio"/>	G63350	61518 81242	58350	43099	<input type="radio"/>	82030
-------	-------	-----------------------	--------	----------------	-------	-------	-------	-----------------------	-------	-------	-------	-------	-------

SCOUT II ESTABILIZADORES DE DIRECCIÓN

71-80	Estabilizador de Dirección Sistema Sencillo									Delantero	Trasero		
-------	---	--	--	--	--	--	--	--	--	-----------	---------	--	--

71-80	Estabilizador de Dirección Sistema Sencillo									6803SE ⁸⁴		
-------	---	--	--	--	--	--	--	--	--	----------------------	-------	--	--

TRAVELALL

75	Todos	<input type="radio"/>	82030	<input type="radio"/>
----	-------	-----------------------	-------	-------	-------	-------	-------	-----------------------	-------	-------	-------	-------	-------

TRAVELALL ESTABILIZADORES DE DIRECCIÓN

75	4WD, Estabilizador de Dirección Sistema Sencillo									Delantero	Trasero		
----	--	--	--	--	--	--	--	--	--	-----------	---------	--	--

75	RWD									6802SE ⁸⁴		
----	-----	--	--	--	--	--	--	--	--	----------------------	-------	--	--

ISUZU

ISUZU

AMIGO

98-00	Todos	<input type="radio"/>	G63611	61593 81872	<input type="radio"/>	G63710	61610 81911
-------	-------	-----------------------	--------	----------------	-------	-------	-------	-----------------------	--------	----------------	-------	-------	-------

89-94	Todos	<input type="radio"/>	G63909	61508 81507	77909	<input type="radio"/>	G63928	61506 81318	49311 ⁷
-------	-------	-----------------------	--------	----------------	-------	-------	-------	-----------------------	--------	----------------	-------	-------	--------------------

ASCENDER

03-08	Todos	<input type="radio"/>	G51718	143241 ⁵³	<input type="radio"/>
-------	-------	-----------------------	--------	-------	-------	----------------------	-------	-----------------------	-------	-------	-------	-------	-------

03-08	Coil(RearSpringType)	<input type="radio"/>	G51718	143241 ⁵³	<input type="radio"/>	G63842	61717
-------	----------------------	-----------------------	--------	-------	-------	----------------------	-------	-----------------------	--------	-------	-------	-------	-------

ASCENDER READYMOUNTS

03-08	Todos									Delantero	Trasero		
-------	-------	--	--	--	--	--	--	--	--	-----------	---------	--	--

03-08	Todos									G57022 ¹⁰		
-------	-------	--	--	--	--	--	--	--	--	----------------------	-------	--	--

7 Paquetes en pares; kit de mangueras de aire incluido

40 Strut ReadyMount. Ensemble Completo

84 Amortiguador de repuesto para los vehículos con el kit de montaje aftermarket



GRC

Texto en Negritas - Número de Parte Nuevo / Futuro

8 Paquetes en pares

53 Montaje de Strut. Es probable reutilizar algunas partes del E.O.

AMORTIGUADORES Y STRUTS

Año	Notas de Aplicación										
		Ultra	ProGuard\ Guardian	LTV\ Max Control	Protector de Strut\ Bases de Strut	HiJacker\ Soporte\ Hidráulico	Ultra	ProGuard\ Guardian	LTV\ Max Control	Protector de Strut\ Bases de Strut	HiJacker\ Soporte\ Hidráulico

ISUZU

ISUZU

AXIOM

02-04	Todos	○	G63611	61593 81872	○	G63710	61610 81911
-------	-------	---	--------	----------------	------	------	------	---	--------	----------------	------	------	------

HOMBRE

99-00	4WD	○	G63423	61531 81516	77423	⊕	G63422	61528 81482	58422 77422	43162 ⁸ 49213 ⁷
	4WD, RWD, Chasis Deportivo	○	58423	⊕	G63422	61528 81482	58422 77422	43162 ⁸ 49213 ⁷
98-00	Todos	○	⊕	G63422	61528 81482	58422 77422	43162 ⁸ 49213 ⁷
	RWD, Exc. Chasis Deportivo	⊖	G63421	61504 81750	58421 77421	⊕	G63422	61528 81482	58422 77422	43162 ⁸ 49213 ⁷
	RWD; Exc. Chasis Deportivo	⊖	34051 ⁸	⊕	G63422	61528 81482	58422 77422	43162 ⁸ 49213 ⁷
98	4WD, RWD, Chasis Deportivo	○	G63423	61531 81516	58423 77423	⊕	G63422	61528 81482	58422 77422	43162 ⁸ 49213 ⁷
96-97	RWD	○	⊕	G63422	61528 81482	58422 77422	43162 ⁸ 49213 ⁷
	RWD, Chasis Deportivo	○	G63423	61531 81516	58423 77423	⊖
	RWD, Exc. Chasis Deportivo	⊖	G63421	61504 81750	58421 77421	⊖
	RWD; Exc. Chasis Deportivo	⊖	34051 ⁸	⊖

I-280

06	Todos	○	⊕	G63882
	RWD, Exc. Paquete Z71 Off Road	⊖	G51850	⊕	G63882

I-290

07-08	Todos	○	⊕	G63882
	RWD, Exc. Paquete Z71 Off Road	⊖	G51850	⊕	G63882

I-350

06	Barra de Torsion(FrontSpringType)	○	G63884	⊖
----	-----------------------------------	---	--------	------	------	------	------	---	------	------	------	------	------

I-370

08	Todos	○	⊕	G63882
	RWD, Coil(FrontSpringType) Exc. Paquete Z71 Off Road	⊖	G51850	⊕	G63882
07	Barra de Torsion(FrontSpringType)	○	G63884	⊕	G63879

I-MARK

88-89	Todos	⊖	G55719	⊖
	XS	⊖	G55719	⊖	81558
85-87	Todos	⊖	G55719	⊖	81558
81-84	Todos	○	81322	⊖



IMPULSE

90-92	Todos	⊖	G55780	⊖
	Exc. Suspensión Lotus	⊖	G55780	142317 ⁵³	⊖
	FWD	⊖	G55780	⊖	G55776

7 Paquetes en pares; kit de mangueras de aire incluido
53 Montaje de Strut. Es probable reutilizar algunas partes del E.O.

8 Paquetes en pares



AMORTIGUADORES Y STRUTS

Año	Notas de Aplicación	From					Rear				
			Ultra	ProGuard\ Guardian	LTV\ Max Control	Protector de Strut\ Bases de Strut	HiJacker\ Soporte\ Hidráulico		Ultra	ProGuard\ Guardian	LTV\ Max Control



ISUZU

ISUZU

















IMPULSE (cont)

83-89	Todos		81322		81340
-------	-------	---	-------	-------	-------	-------	-------	---	-------	-------	-------	-------	-------





OASIS

96-99	Todos		G55877	142230 ⁵³		G55821	142230 ⁵³
-------	-------	---	--------	-------	-------	----------------------	-------	---	--------	-------	-------	----------------------	-------





PICKUP

82-95	Todos			61506 81318	77492	49311
	4WD		G63909	61508 81507	77909		G63928	61506 81318	77492	49311
	RWD		G63902	61501 81478	77902		G63492	61506 81318	77492	49311
	RWD		70161		61506 81318	77492	49311
81	Todos			61506 81318	77492	49311 ⁷
	4WD		G63909	61508 81507	77909		G63928	61506 81318	77492	49311 ⁷
	RWD		G63902	61501 81478	77902		G63492	61506 81318	77492	49311 ⁷
	RWD		70161		61506 81318	77492	49311 ⁷









RODEO

98-04	Todos		G63611	61593 81872		G63710	61610 81911
91-97	Todos		G63611	61593 81872		G63610	61592 81937

STYLUS

91-93	Todos		G55780		G55776
	Exc. Suspensión Lotus		G55780	142317 ⁵³		G55776

TROOPER

92-02	Todos		G63707	61607		G63708	61608 81909
89-91	Todos		G63495	61593 81553	77904		61586
87-88	Todos		G63495	61593 81553	77904		61558 82066
84-86	Todos		G63909	61508 81507	77909		G63928	61506 81318	49311 ⁷

TROOPER ESTABILIZADORES DE DIRECCIÓN

									Delantero	Trasero			
84-91	4WD, Estabilizador de Dirección Sistema Sencillo								6802SE ⁸⁴			







VEHICROSS

99-01	Todos		G63707	61607		G63708	61608 81909
-------	-------	---	--------	-------	-------	-------	-------	---	--------	----------------	-------	-------	-------

JAGUAR

JAGUAR

S TYPE

00-06	Exc. Suspensión de Tecnología Computarizada Activa (CATS)		143242 ⁵³		143242 ⁵³
03-05	Fab. hasta 6un/02 Exc. Suspensión de tecnología computarizada activa (CATS)			G51773
00-02	Fab. hasta 6un/02 Exc. Suspensión de tecnología computarizada activa (CATS)		G51769		G51773

7 Paquetes en pares; kit de mangueras de aire incluido

53 Montaje de Strut. Es probable reutilizar algunas partes del E.O.

84 Amortiguador de repuesto para los vehículos con el kit de montaje aftermarket GRC

AMORTIGUADORES Y STRUTS

Año	Notas de Aplicación	Front					Rear				
		Ultra	ProGuard\ Guardian	LTV\ Max Control	Protector de Strut\ Bases de Strut	HiJacker\ Soporte\ Hidráulico	Ultra	ProGuard\ Guardian	LTV\ Max Control	Protector de Strut\ Bases de Strut	HiJacker\ Soporte\ Hidráulico

JAGUAR

JAGUAR

X-TYPE

02-08	Exc. Suspensión de tecnología computarizada activa (CATS)	↑	G52276
	Exc. Suspensión de Tecnología Computarizada Activa (CATS)	↑	143403

XJ6

87-94	Exc. Sistema de Autonivelación	↑	G51711
72-86	Todos	○	69677
	4 amortiguadores requeridos	○	69677	G51161

XJ12

94	Exc. Sistema de Autonivelación	↑	G51711
81-92	Todos	○	69677
	4 amortiguadores requeridos	○	69677	G51161
73-79	Todos	○	69677
	4 amortiguadores requeridos	○	69677	G51161

XJS

76-96	Todos	○	69677	G51161
-------	-------	---	-------	------	------	------	------	------	--------	------	------	------	------

XK150

58-61	Todos	○	82123
-------	-------	---	------	------	------	------	------	------	------	-------	------	------	------

XKE

62-64	Todos		81270	49105 ⁷
-------	-------	--	------	------	------	------	------	------	------	-------	------	------	--------------------

JEEP

JEEP

CHEROKEE

84-01	Todos	↑	G63424	61535 81548	77424	G63425	61536 81549	77425	49226 ⁷
76-83	Todos	○	G63377	61519 81484	58377 77377	G63377	61519 81484	58377 77377	43058 ⁸ 49127 ⁷
75	Todos	○	G63377	61519 81484	58377 77377	43058
74	Todos	○	G63377	61519 81484	58377 77377	81676	43058

CHEROKEE ESTABILIZADORES DE DIRECCIÓN

		Delantero		Trasero	
84-01	Todos	14040		
84-00	Estabilizador de Dirección Sistema Sencillo; con orificio de montaje de EO en brazo de dirección	6801SE ⁸⁰		
75-83	4WD, Estabilizador de Dirección Sistema Sencillo	6804SE ⁸⁰		
74	Estabilizador de Dirección Sistema Sencillo	6804SE ⁸⁰		

CJ3

61-66	Exc. 5 Resortes Helicoidales Delanteros y Kit de Levantamiento	○	82007
65	Exc. Kit de Levantamiento	○	G63405
	Kit de Levantamiento de 2-4"	○	G63440 ⁵⁰

CJ5

82-83	Exc. Kit de Levantamiento	○	G63377	61519 81484	77377	G63405	61500 81147	77405	43048 ⁸ 49310 ⁷
-------	---------------------------	---	--------	----------------	-------	------	------	------	------	--------	----------------	-------	------	--

7 Paquetes en pares; kit de mangueras de aire incluido

50 Para proteger la barra del pistón, se recomienda utilizar el kit Bellows No.141242.

8 Paquetes en pares

80 No requiere soportes para el montaje, instalar sobre montajes de EO Vea Ref. C para Botas.

AMORTIGUADORES Y STRUTS

Año	Notas de Aplicación	Front					Rear				
		Ultra	ProGuard\ Guardian	LTV\ Max Control	Protector de Strut\ Bases de Strut	HiJacker\ Soporte\ Hidráulico	Ultra	ProGuard\ Guardian	LTV\ Max Control	Protector de Strut\ Bases de Strut	HiJacker\ Soporte\ Hidráulico

JEEP

JEEP

CJ5 (cont)

82-83	Kit de Levantamiento de 2"	○	G63443 ⁵⁰
	Kit de Levantamiento de 2-4"	○	G63441	○
	Kit de Levantamiento de 3-4"	○	G63440 ⁵⁰
72-81	Exc. Kit de Levantamiento	○	G63299	82007	○	G63405	61500 81147	77405	...	43048 ⁸ 49310 ⁷
	Kit de Levantamiento de 2-4"	○	G63443 ⁵⁰	○	G63440 ⁵⁰
66-71	Todos	○	...	61500	43048 ⁸ 49310 ⁷
	Exc. 5 Resortes Helicoidales Delanteros y Kit de Levantamiento	○	...	82007	○	...	81147 61500	43048 ⁸ 49310 ⁷
	Exc. Kit de Levantamiento	○	G63405	61500	77405	...	43048 ⁸ 49310 ⁷
	Kit de Levantamiento de 2-4"	○	G63443 ⁵⁰	○	G63440 ⁵⁰	61500	43048 ⁸ 49310 ⁷
	Resorte Frontal de 5 Hojas Exc. Kit de Levantamiento	81676	○	...	81676 61500	43048 ⁸ 49310 ⁷
61-65	Exc. 5 Resortes Helicoidales Delanteros y Kit de Levantamiento	○	...	82007	○
65	Exc. Kit de Levantamiento	○	G63405
	Kit de Levantamiento de 2-4"	○	G63440 ⁵⁰

CJ5 ESTABILIZADORES DE DIRECCIÓN

		Delantero	Trasero
66-83	Estabilizador de Dirección Sistema Sencillo	6802SE ⁸⁴	...
59-60	Estabilizador de Dirección Sistema Sencillo	6802SE ⁸⁴	...

CJ5D

84-86	4.2L 6Cyl (258) 4BBL	○	G63377	81484	○
	4.6L 6Cyl (282) 4WD; 2BBL	○	G63377	81484	○
82-83	4.6L 6Cyl (282) 4WD; 2BBL	○	G63377	81484	○	...	81147
73-81	4.6L 6Cyl (282) 4WD; 2BBL	○	G63299	82007	○	...	81147
75-78	4.2L 6Cyl (258) 4BBL	○	G63299	82007	○	...	81147
65-71	3.8L 6Cyl (232) RWD; 4BBL	○	G63299	81676	○	...	81147
	4.2L 6Cyl (258) 4BBL	○	G63299	81676	○	...	81147

CJ5S

66-71	4.2L 6Cyl (258) 4WD; 1BBL	○	...	81676	○	...	81147
71	3.8L 6Cyl (232) RWD; DOHC; MFI	○	...	81676	○	...	81147
70	3.8L 6Cyl (232) RWD; DOHC; FI	○	...	81676	○
	3.8L 6Cyl (232) RWD; DOHC; MFI	○	○	...	81147
68-69	3.8L 6Cyl (232) RWD; DOHC; FI	○	...	81676	○	...	81147
65-67	3.8L 6Cyl (232) RWD; 4BBL	○	...	81676	○	...	81147
65	4.2L 6Cyl (258) 4BBL	○	...	81676	○	...	81147

CJ6





72-75	Exc. Kit de Levantamiento	○	G63299	82007	○	G63405	61500 81147	77405	...	43048 ⁸ 49310 ⁷
	Kit de Levantamiento de 2-4"	○	G63443 ⁵⁰	○	G63440 ⁵⁰
66-71	Todos	○	...	61500	43048 ⁸ 49310 ⁷
	Exc. 5 Resortes Helicoidales Delanteros y Kit de Levantamiento	○	...	82007	○	...	61500	43048 ⁸ 49310 ⁷
	Exc. Kit de Levantamiento	○	G63405	81147 61500	77405	...	43048 ⁸ 49310 ⁷

7 Paquetes en pares; kit de mangueras de aire incluido

8 Paquetes en pares

50 Para proteger la barra del pistón, se recomienda utilizar el kit Bellows No.141242. 84 Amortiguador de repuesto para los vehículos con el kit de montaje aftermarket GRC









AMORTIGUADORES Y STRUTS

Año	Notas de Aplicación										
			Ultra	ProGuard\ Guardian	LTV\ Max Control	Protector de Strut\ Bases de Strut	HiJacker\ Soporte\ Hidráulico		Ultra	ProGuard\ Guardian	LTV\ Max Control

JEEP

JEEP































CJ6 (cont)

66-71	Kit de Levantamiento de 2-4"		G63443 ⁵⁰		G63440 ⁵⁰	61500	43048 ⁸ 49310 ⁷
	Resorte Frontal de 5 Hojas Exc. Kit de Levantamiento		81676		81676 61500
65	Exc. Kit de Levantamiento			G63405
	Kit de Levantamiento de 2-4"			G63440 ⁵⁰

CJ6 ESTABILIZADORES DE DIRECCIÓN

		Delantero	Trasero
66-75	Estabilizador de Dirección Sistema Sencillo	6802SE ⁸⁴
59-60	Estabilizador de Dirección Sistema Sencillo	6802SE ⁸⁴



CJ7

82-86	Todos		81484	
	Exc. Kit de Levantamiento		G63377	61519 81484	77377		G63405	61500 81147	77405	43048 ⁸ 49310 ⁷
	Kit de Levantamiento de 2"		81484		G63443 ⁵⁰
	Kit de Levantamiento de 2-4"		G63441 ⁵⁰	81484	
	Kit de Levantamiento de 3-4"		81484		G63440 ⁵⁰
	4.6L 6Cyl (282) 4WD; 2BBL		81484	
76-81	Exc. Kit de Levantamiento		G63299	82007		G63405	61500 81147	77405	43048 ⁸ 49310 ⁷
	Kit de Levantamiento de 2-4"		G63443 ⁵⁰		G63440 ⁵⁰
69-75	3.8L 6Cyl (232) RWD; FI		42973		G63928	81147
68-75	4.2L 6Cyl (258) 4WD; 2BBL		42973		G63928	81147
	Excluye kit de levante			61500
68	3.8L 6Cyl (232) RWD; DOHC; MFI		42973		G63928
	3.8L 6Cyl (232) RWD; FI			81147
65-67	3.8L 6Cyl (232) RWD; DOHC; MFI			81147
	4.2L 6Cyl (258) 4WD; 2BBL			81147



CJ7 ESTABILIZADORES DE DIRECCIÓN

		Delantero	Trasero
76-86	Estabilizador de Dirección Sistema Sencillo	6802SE ⁸⁴

CJ10

84-85	4.6L 6Cyl (282) 4WD; 2BBL		G63377	81484		81147
-------	---------------------------	---	--------	-------	------	------	------	---	------	-------	------	------	------



COMANCHE

86-92	Todos		G63424	61535 81548	77424		G63492	61506 81318	77492
-------	-------	---	--------	----------------	-------	------	------	---	--------	----------------	-------	------	------



COMANCHE ESTABILIZADORES DE DIRECCIÓN

		Delantero	Trasero
86-92	Todos	14040
	Estabilizador de Dirección Sistema Sencillo; con orificio de montaje de EO en brazo de dirección	6801SE ⁸⁰

COMMANDER

06-10	Todos		G56807	143364 ³		G64012	61715
-------	-------	---	--------	------	------	---------------------	------	---	--------	-------	------	------	------

COMPASS

11-12	Todos			143337 ⁵³
-------	-------	---	------	------	------	------	------	---	------	------	------	----------------------	------

3 Número de parte futuro

8 Paquetes en pares

53 Montaje de Strut. Es probable reutilizar algunas partes del E.O.

84 Amortiguador de repuesto para los vehículos con el kit de montaje aftermarket GRC

7 Paquetes en pares; kit de mangueras de aire incluido

50 Para proteger la barra del pistón, se recomienda utilizar el kit Bellows No.141242.

80 No requiere soportes para el montaje, instalar sobre montajes de EO Vea Ref. C para Botas.

AMORTIGUADORES Y STRUTS

Año	Notas de Aplicación	From					Rear				
		Ultra	ProGuard\ Guardian	LTV\ Max Control	Protector de Strut\ Bases de Strut	HiJacker\ Soporte\ Hidráulico	Ultra	ProGuard\ Guardian	LTV\ Max Control	Protector de Strut\ Bases de Strut	HiJacker\ Soporte\ Hidráulico

JEEP

JEEP

COMPASS (cont)

07-10	Izquierdo	↓	G52081	143495 ⁵⁴	↓	G51842	143337 ⁵³
	Derecho	↓	G52082	143495 ⁵⁴	↓	G51842	143337 ⁵³

DISPATCHER

61-67	Todos	○	81676	○	81676
-------	-------	---	------	-------	------	------	------	---	------	-------	------	------	------

DJ5

66-74	Exc. Kit de Levantamiento	○	G63299	82007	○	G63405	61500 81147	77405	43048 ⁸ 49310 ⁷
	Kit de Levantamiento de 2-4"	○	G63443 ⁵⁰	○	G63440 ⁵⁰

DJ6

66-68	Todos	○	82007	○	61500 81147	43048 ⁸ 49310 ⁷
	Exc. Kit de Levantamiento	○	82007	○	G63405	61500 81147	77405	43048 ⁸ 49310 ⁷
	Kit de Levantamiento de 2-4"	○	G63443 ⁵⁰	82007	○	G63440 ⁵⁰	61500 81147	43048 ⁸ 49310 ⁷

FC150

61-65	Todos	○	82007	○	81676
57-60	Todos	○	82007	○	G63405	61500 81147	77405	43048 ⁸ 49310 ⁷

FC170

63-65	Todos	○	G63405	61500 81147	77405	○	G63405	61500 81147	77405	43048 ⁸ 49310 ⁷
-------	-------	---	--------	----------------	-------	------	------	---	--------	----------------	-------	------	--

GLADIATOR

67	Todos	○	81318	○	61519 81484	43058 ⁸ 49127 ⁷
66	Todos	○	81318	○	81147	49310 ⁷
	Suspensión Delantera Independiente	○	81318	○	G63405	61500 81147	77405	43048 ⁸ 49310 ⁷
64-65	Todos	○	○	81147	49310 ⁷
	Exc. Suspensión Independiente Delantera	○	81318	○	81147	49310 ⁷
63-65	Suspensión Delantera Independiente	○	○	G63405	61500 81147	77405	43048 ⁸ 49310 ⁷

GLADIATOR ESTABILIZADORES DE DIRECCIÓN

		Delantero		Trasero	
63-67	Estabilizador de Dirección Sistema Sencillo	6803SE ⁸⁴		

GRAND CHEROKEE

11-15	Todos	↓	↓	G511000
05-10	Todos	↓	G56807	143364 ³	↓	G64012	61715
99-04	Todos	↓	81869	↓	G63829	61676 81926	77829
	Exc. Suspensión Up Country	↓	G63847	61664 81869	77847	↓	G63829	61676 81926	77829
95-98	Todos	↓	G63424	61535 81548	77424	↓	G63683	61575 81891	77683
93-94	Todos	↓	G63424	61535 81548	77424	↓	G63626	61575 81891	77683
92	4L 6Cyl (242) RWD; TBI	↓	G63424	81548	↓

3 Número de parte futuro

8 Paquetes en pares

53 Montaje de Strut. Es probable reutilizar algunas partes del E.O.

84 Amortiguador de repuesto para los vehículos con el kit de montaje aftermarket

GRC





Texto en Negritas - Número de Parte Nuevo / Futuro

7 Paquetes en pares; kit de mangueras de aire incluido

50 Para proteger la barra del pistón, se recomienda utilizar el kit Bellows No.141242.

54 Kit con Montaje y Rodamiento. Es probable que reutilizar algunas partes del E.O.

AMORTIGUADORES Y STRUTS

Año	Notas de Aplicación										
			Ultra	ProGuard\ Guardian	LTV\ Max Control	Protector de Strut\ Bases de Strut	HiJacker\ Soporte\ Hidráulico		Ultra	ProGuard\ Guardian	LTV\ Max Control

JEEP

JEEP

GRAND CHEROKEE (cont)

92	5.2L 8Cyl (318) MFI		G63424	81548
----	---------------------	---	--------	-------	------	------	------	------	------	------	------	------





GRAND CHEROKEE ESTABILIZADORES DE DIRECCIÓN

								Delantero	Trasero
99-04	Amortiguador de Dirección Sistema Sencillo							14071
93-98	Todos							6853SE ⁸²

GRAND CHEROKEE READYMOUNTS

								Delantero	Trasero
05-10	4WD; V8 Models							G57083 ⁴⁰



GRAND WAGONEER

93	Exc. Suspensión Up Country		81548
	4WD, Exc. Suspensión Up Country		G63424	61535 81548	77424
84-91	Todos		70172
	Todos		G63377	61519 81484	58377 77377	G63377	61519 81484	58377 77377
84	Exc. Suspensión Up Country		77424	70172

GRAND WAGONEER ESTABILIZADORES DE DIRECCIÓN

								Delantero	Trasero
84-91	Estabilizador de Dirección Sistema Sencillo							6804SE ⁸⁰



J10 PICKUP

74-88	Todos		70172
	Todos		G63377	61519 81484	77377	G63377	61519 81484	77377

J10 PICKUP ESTABILIZADORES DE DIRECCIÓN

								Delantero	Trasero
74-88	Estabilizador de Dirección Sistema Sencillo							6804SE ⁸⁰





J20 PICKUP

74-88	Todos		70172
	Todos		G63377	61519 81484	77377	G63377	61519 81484	77377

J20 PICKUP ESTABILIZADORES DE DIRECCIÓN

								Delantero	Trasero
74-88	Estabilizador de Dirección Sistema Sencillo							6804SE ⁸⁰

J100

84-86	4.6L 6Cyl (282) 4WD; 4BBL		G63377	61519	G63377
83	4.6L 6Cyl (282) 4WD; 2BBL		61500	42973
	4.6L 6Cyl (282) 4WD; 4BBL		42973
80-82	4.6L 6Cyl (282) 4WD; 2BBL		61500	42973

J162

68-69	3.8L 6Cyl (232) RWD; SFI		81318	61500 81147
	4.2L 6Cyl (258) 4WD; 2BBL		81318	61500 81147

7 Paquetes en pares; kit de mangueras de aire incluido
40 Strut ReadyMount. Ensamble Completo
82 Use kit si está señalado. Vea Ref. C para Botas.

8 Paquetes en pares
80 No requiere soportes para el montaje, instalar sobre montajes de EO Vea Ref. C para Botas.

Texto en Negritas - Número de Parte Nuevo / Futuro

AMORTIGUADORES Y STRUTS

Año	Notas de Aplicación	Front					Rear				
		Ultra	ProGuard\ Guardian	LTV\ Max Control	Protector de Strut\ Bases de Strut	HiJacker\ Soporte\ Hidráulico	Ultra	ProGuard\ Guardian	LTV\ Max Control	Protector de Strut\ Bases de Strut	HiJacker\ Soporte\ Hidráulico

JEEP

JEEP

J162 (cont)

65	4.2L 6Cyl (258) 4WD; 2BBL	○	81318	○	61500 81147
----	---------------------------	---	-------	-------	-------	-------	-------	---	-------	----------------	-------	-------	-------

J164

74-86	4.6L 6Cyl (282) 4WD; 4BBL	○	G63377	81484	○
73	4.6L 6Cyl (282) 4WD; 4BBL	○	81318	○
71-72	4.2L 6Cyl (258) 4WD; 2BBL	○	81318	○
72	3.8L 6Cyl (232) RWD; SOHC; MFI	○	81318	○
71	3.8L 6Cyl (232) RWD; SOHC; FI	○	81318	○
67-70	3.8L 6Cyl (232) RWD; SOHC; FI	○	81318	○	61500 81147
65-70	4.2L 6Cyl (258) 4WD; 2BBL	○	81318	○	61500 81147

J164V

74-86	4.6L 6Cyl (282) 4WD; 4BBL	○	G63377	81484	○
73	4.6L 6Cyl (282) 4WD; 4BBL	○	81318	○
71-72	3.8L 6Cyl (232) RWD; TBI	○	81318	○
	4.2L 6Cyl (258) 4WD; 2BBL	○	81318	○
68-70	3.8L 6Cyl (232) RWD; TBI	○	81318	○	61500 81147
67-70	4.2L 6Cyl (258) 4WD; 2BBL	○	81318	○	61500 81147
67	3.8L 6Cyl (232) RWD; SOHC; MFI	○	81318	○	61500
	3.8L 6Cyl (232) RWD; TBI	○	○	81147
66	4.2L 6Cyl (258) 4WD; 2BBL	○	81318	○	81147
65	4.2L 6Cyl (258) 4WD; 2BBL	○	81318	○	61500 81147

J262S

71	3.8L 6Cyl (232) RWD; TBI	○	81318	○	61500 81147
	4.2L 6Cyl (258) 4WD; 2BBL	○	81318	○	61500 81147
68-69	3.8L 6Cyl (232) RWD; TBI	○	81318	○	61500 81147
	4.2L 6Cyl (258) 4WD; 2BBL	○	81318	○	61500 81147

J264D

67	3.8L 6Cyl (232) RWD; TBI	○	81318	○	61500
	4.2L 6Cyl (258) 4WD; 2BBL	○	81318	○	61500
65	4.2L 6Cyl (258) 4WD; 2BBL	○	81318	○	61500 81147

J364R

74-84	4.6L 6Cyl (282) 4WD; 4BBL	○	81484	○
73	4.6L 6Cyl (282) 4WD; 4BBL	○	81318	○	61500
67-72	3.8L 6Cyl (232) RWD; TBI	○	81318	○	61500
65-72	4.2L 6Cyl (258) 4WD; 2BBL	○	81318	○	61500





J2500 PICKUP

68-73	Todos	○	81318	○	61519 81484	43058 ⁸ 49127 ⁷
-------	-------	---	-------	-------	-------	-------	-------	---	-------	----------------	-------	-------	--

7 Paquetes en pares; kit de mangueras de aire incluido

8 Paquetes en pares





AMORTIGUADORES Y STRUTS

Año	Notas de Aplicación										
			Ultra	ProGuard\ Guardian	LTV\ Max Control	Protector de Strut\ Bases de Strut	HiJacker\ Soporte\ Hidráulico		Ultra	ProGuard\ Guardian	LTV\ Max Control

JEEP

JEEP







JEEPSTER

70-73	Todos		82007		G63405	61500 81147	77405	43048 ⁸ 49310 ⁷
67-69	Todos		82007		82007

JEEPSTER ESTABILIZADORES DE DIRECCIÓN

		Delantero	Trasero
66-73	Estabilizador de Dirección Sistema Sencillo	6802SE ⁸⁴



LIBERTY

12	Todos		G51728		G63844
02-11	Izquierdo		G51728	143255 ⁵³		G63844
	Derecho		G51728	143266 ⁵³		G63844



LIBERTY READYMOUNTS

		Delantero	Trasero
02-12	Gas Izquierdo	G57007 ⁴⁰
	Gas Derecho	G57008 ⁴⁰





PATRIOT

11-12	Todos			143337 ⁵³
07-10	Izquierdo		G52081	143495 ⁵⁴		G51842	143337 ⁵³ 143496 ⁵³
	Derecho		G52082	143495 ⁵⁴		G51842	143337 ⁵³ 143496 ⁵³

PICKUP

84-91	S364			70172
-------	------	---	------	------	------	------	------	---	------	------	------	------	-------





















SCRAMBLER / CJ8

82-85	Todos		G63377	61519 81484	77377		G63405	61500 81147	77405	43048 ⁸ 49310 ⁷
81	Todos		G63299	82007		G63405	61500 81147	77405	43048 ⁸ 49310 ⁷

SCRAMBLER / CJ8 ESTABILIZADORES DE DIRECCIÓN

		Delantero	Trasero
81-85	Estabilizador de Dirección Sistema Sencillo	6802SE ⁸⁴

UNIVERSAL

67	Todos		82007		61500	43048 ⁸ 49310 ⁷
	Exc. CJ-3B		82007		81147 61500	43048 ⁸ 49310 ⁷
	Exc. Kit de Levantamiento		82007		G63405	61500	77405	43048 ⁸ 49310 ⁷
	Kit de Levantamiento de 2-4"		G63443 ⁵⁰	82007		G63440 ⁵⁰	61500	43048 ⁸ 49310 ⁷
	Resorte Frontal de 5 Hojas Exc. Kit de Levantamiento		81676 82007		81676 61500	43048 ⁸ 49310 ⁷
66	Todos		82007		61500	49310 ⁷
	Exc. CJ-3B		82007		81147 61500	49310 ⁷
	Exc. Kit de Levantamiento		82007		G63405	61500	77405	49310 ⁷
	Kit de Levantamiento de 2-4"		G63443 ⁵⁰	82007		G63440 ⁵⁰	61500	49310 ⁷
	Resorte Frontal de 5 Hojas Exc. Kit de Levantamiento		81676 82007		81676 61500	49310 ⁷

7 Paquetes en pares; kit de mangueras de aire incluido

40 Strut ReadyMount. Ensamble Completo

53 Montaje de Strut. Es probable reutilizar algunas partes del E.O.

84 Amortiguador de repuesto para los vehículos con el kit de montaje aftermarket GRC

Texto en Negritas - Número de Parte Nuevo / Futuro

8 Paquetes en pares

50 Para proteger la barra del pistón, se recomienda utilizar el kit Bellows No.141242.

54 Kit con Montaje y Rodamiento. Es probable que reutilizar algunas partes del E.O.

AMORTIGUADORES Y STRUTS

Año	Notas de Aplicación	Front					Rear				
		Ultra	ProGuard\ Guardian	LTV\ Max Control	Protector de Strut\ Bases de Strut	HiJacker\ Soporte\ Hidráulico	Ultra	ProGuard\ Guardian	LTV\ Max Control	Protector de Strut\ Bases de Strut	HiJacker\ Soporte\ Hidráulico

JEEP

JEEP

UNIVERSAL (cont)

65	Todos	○	82007	○	61500	77405	43048 ⁸ 49310 ⁷
	Exc. CJ-3B	○	82007	○	81147 61500	77405	43048 ⁸ 49310 ⁷
	Exc. Kit de Levantamiento	○	82007	○	G63405	61500	77405	43048 ⁸ 49310 ⁷
	Kit de Levantamiento de 2-4"	○	G63443 ⁵⁰	82007	○	G63440 ⁵⁰	61500	77405	43048 ⁸ 49310 ⁷
	Resorte Frontal de 5 Hojas Exc. Kit de Levantamiento	○	81676 82007	○	81676 61500	77405	43048 ⁸ 49310 ⁷
61-64	Todos	○	82007	○	G63405	61500	77405	43048 ⁸ 49310 ⁷
	Exc. CJ-3B	○	82007	○	G63405	81147 61500	77405	43048 ⁸ 49310 ⁷
	Resorte Frontal de 5 Hojas Exc. Kit de Levantamiento	○	81676 82007	○	G63405	81676 61500	77405	43048 ⁸ 49310 ⁷

UNIVERSAL ESTABILIZADORES DE DIRECCIÓN

Delantero Trasero

61-67	Estabilizador de Dirección Sistema Sencillo	6802SE ⁸⁴
-------	---	----------------------	-------

WAGONEER

87-90	Todos	⊕	G63424	61535 81548	77424	⊕	G63425	61536 81549	77425	49226 ⁷
84-86	Todos	⊕	G63424	61535 81548	77424	42973	⊕	G63425	61536 81549	77425	49226 ⁷
76-86	Todos	⊕	42973	⊕
76-83	Todos	○	G63377	61519 81484	58377 77377	42973	○	G63377	61519 81484	58377 77377	43058 ⁸ 49127 ⁷
75	Todos	○	G63377	61519 81484	58377 77377	○	43058
74	Todos	○	G63377	61519 81484	58377 77377	○	G63299	81676	43058
71-73	Todos	○	G63492	81318	77492	○	G63299	81676
68-70	Todos	○	G63492	81318	77492	○	81676
66-67	Todos	○	G63492	81318	77492	○	G63299	81676
63-65	Todos	○	○	G63299	81676
	Exc. Suspensión Independiente Delantera	○	G63492	81318	77492	○	G63299	81676
	Suspensión Delantera Independiente	○	81676	○	G63299	81676

WAGONEER ESTABILIZADORES DE DIRECCIÓN

Delantero Trasero

63-67	Exc. Suspensión Independiente Delantera	6802SE ⁸⁴
-------	---	----------------------	-------

WRANGLER





13-15	Todos	⊕	61711	⊕	G63966
	Exc. Ruedas de 17"	⊕	61711	⊕	G63966	61696
	Ruedas de 17"	⊕	61711	⊕	G63967 G63966	61697
13-14	Unlimited Sahara, 4WD	⊕	61711	⊕	G63966	77973
07-12	Todos	⊕	G64008	61711	77972 77981	⊕
	Exc. Ruedas de 17"	⊕	G64008	61711	77972 77981	⊕	G63966	61696
	Ruedas de 17"	⊕	G64008	61711	77972 77981	⊕	G63967	61697
12	Unlimited Sahara, 4WD	⊕	G64008	61711	77972 77981	⊕	77973
07-11	Unlimited Sahara, Unlimited X, 4WD	⊕	G64008	61711	77972 77981	⊕	77973

7 Paquetes en pares; kit de mangueras de aire incluido

8 Paquetes en pares

50 Para proteger la barra del pistón, se recomienda utilizar el kit Bellows No.141242. 84 Amortiguador de repuesto para los vehículos con el kit de montaje aftermarket GRC









AMORTIGUADORES Y STRUTS

Año	Notas de Aplicación										
			Ultra	ProGuard\ Guardian	LTV\ Max Control	Protector de Strut\ Bases de Strut	HiJacker\ Soporte\ Hidráulico		Ultra	ProGuard\ Guardian	LTV\ Max Control

JEEP

JEEP

WRANGLER (cont)

07-11	X		G64008	61711	77972 77981		77973
97-06	Todos		77978		77979
	TJ(Cdigo plataforma del fabricante)		G63721	61615 81936	77978		G63722	61616 81929	77979
87-95	YJ(Cdigo plataforma del fabricante)		G63511	61551 ⁶ 81691		G63490	61541 81583	49222 ⁷





WRANGLER ESTABILIZADORES DE DIRECCIÓN

							Delantero	Trasero
07-13	4WD						14074
97-06	TJ(Cdigo plataforma del fabricante) Estabilizador de Dirección Sistema Sencillo; con orificio de montaje de EO en brazo de dirección						6801SE ⁸⁰
94-95	YJ(Cdigo plataforma del fabricante) Estabilizador de Dirección Sistema Sencillo; con orificio de montaje de EO en brazo de dirección						6801SE ⁸⁰
87-92	YJ(Cdigo plataforma del fabricante) Estabilizador de Dirección Sistema Sencillo; con orificio de montaje de EO en brazo de dirección						6801SE ⁸⁰



KIA

KIA











AMANTI

07-09	Todos		G511071	143342 ⁵³		G51994
04-06	Todos		G51774	143419 ⁵³		G51825	143419 ⁵³

CADENZA

14	Todos			70068
----	-------	---	------	------	------	------	------	---	-------	------	------	------	------













MAGENTIS

07-10	Izquierdo		G52247	143381 ⁵³		70049
	Derecho		G52248	143382 ⁵³		70049
06	Izquierdo		G51714	143381 ⁵³		G51713	142419 ⁵³
	Derecho		G51714	143382 ⁵³		G51713	142419 ⁵³
01-05	Todos		G51714		G51713	142419 ⁵³

MAGENTIS READYMOUNTS

							Delantero	Trasero
01-06	Izquierdo						G57090 ¹⁰
	Derecho						G57091 ¹⁰

OPTIMA

11	Todos			70068
07-10	Izquierdo		G52247	143381 ⁵³		70049
	Derecho		G52248	143382 ⁵³		70049
06	Izquierdo		G52247	143381 ⁵³		G51713	142419 ⁵³
	Derecho		G52248	143382 ⁵³		G51713	142419 ⁵³
01-05	Todos		G51714		G51713	142419 ⁵³

6 Se recomienda que cuando se reemplacen amortiguadores "quad", los 4 sean de la misma serie.

40 Strut ReadyMount. Ensemble Completo

80 No requiere soportes para el montaje, instalar sobre montajes de EO Vea Ref. C para Botas.

Texto en Negritas - Número de Parte Nuevo / Futuro

7 Paquetes en pares; kit de mangueras de aire incluido

53 Montaje de Strut. Es probable reutilizar algunas partes del E.O.

AMORTIGUADORES Y STRUTS

Año	Notas de Aplicación	Front					Rear				
		Ultra	ProGuard\ Guardian	LTV\ Max Control	Protector de Strut\ Bases de Strut	HiJacker\ Soporte\ Hidráulico	Ultra	ProGuard\ Guardian	LTV\ Max Control	Protector de Strut\ Bases de Strut	HiJacker\ Soporte\ Hidráulico

KIA

KIA

OPTIMA READYMOUNTS

		Delantero	Trasero
01-06	Izquierdo	G57090 ⁴⁰
	Derecho	G57091 ⁴⁰

RIO

14-15	Izquierdo	G52353	70095
	Derecho	G52354	70095
06-11	Izquierdo	G52154	143409	70036	142419 ⁵³ 143411
	Derecho	G52155	143410	70036	142419 ⁵³ 143411
04-05	Izquierdo	G52015	70001
	Derecho	G52016	70001
	Sedan Izquierdo	143456 ⁵³
	Sedan Derecho	143457 ⁵³
01-03	Izquierdo	G56782	69585 G63880
	Derecho	G56781	69585 G63880

RONDO

07-11	Izquierdo	G52247	70049	143386 ⁵³
	Derecho	G52248	70049	143386 ⁵³

SEDONA

06-11	Izquierdo	G52257	143416 ⁵³	G64071
	Derecho	G52258	143416 ⁵³	G64071
02-05	Izquierdo	G52034	143458 ³	70000
	Derecho	G52035	143458 ³	70000

SEPHIA

00-01	Todos	142856 ⁵⁴
01	Izquierdo Fab. hasta 6/01	142856 ⁵⁴	G56534
	Derecho Fab. hasta 6/01	142856 ⁵⁴	G56533
	Fab. hasta 6/01 Izquierdo	G56532	142856 ⁵⁴	142642 ⁵³
	Fab. hasta 6/01 Derecho	G56531	142856 ⁵⁴	142641 ⁵³
00	Izquierdo Fab. hasta 6/01	142856 ⁵⁴	G56534	142642 ⁵³
	Derecho Fab. hasta 6/01	142856 ⁵⁴	G56533	142641 ⁵³
	Fab. hasta 6/01 Izquierdo	142856 ⁵⁴	142642 ⁵³

3 Número de parte futuro

53 Montaje de Strut. Es probable reutilizar algunas partes del E.O.

Texto en Negritas - Número de Parte Nuevo / Futuro

40 Strut ReadyMount. Ensamble Completo

54 Kit con Montaje y Rodamiento. Es probable que reutilizar algunas partes del E.O.

AMORTIGUADORES Y STRUTS

Año	Notas de Aplicación	Front					Rear				
		Ultra	ProGuard\ Guardian	LTV\ Max Control	Protector de Strut\ Bases de Strut	HiJacker\ Soporte\ Hidráulico	Ultra	ProGuard\ Guardian	LTV\ Max Control	Protector de Strut\ Bases de Strut	HiJacker\ Soporte\ Hidráulico

KIA

KIA

SEPHIA (cont)

00	Fab. hasta 6/01 Derecho	142856 ⁵⁴	142641 ⁵³
	Non-ABS Izquierdo Fab. hasta 6/01	G56532	142856 ⁵⁴
	Non-ABS Derecho Fab. hasta 6/01	G56531	142856 ⁵⁴
98-99	Izquierdo	142856 ⁵⁴	G56534	142642 ⁵³
	Derecho	142856 ⁵⁴	G56533	142641 ⁵³
	Non-ABS Izquierdo	G56532
	Non-ABS Derecho	G56531
94-97	Izquierdo	G56570	G56637	142642 ⁵³
	Derecho	G56569	G56571	142641 ⁵³

SORENTO

07-09	Izquierdo Exc. HPD (High Performance Dampers)	G511054	O	70078
	Derecho Exc. HPD (High Performance Dampers)	G511055	O	70078
03-06	Izquierdo	G52036	143226 ⁵³	O	G64032
	Derecho	G52037	143226 ⁵³	O	G64032

SPECTRA

04-09	Izquierdo	G52160	G52162	142535 ⁵³
	Derecho	G52161	G52163	142536 ⁵³
02-03	Izquierdo	G56892	G52017
	Derecho	G56893	G52018
00-01	Izquierdo	G52063
	Izquierdo Fab. hasta 6/01	G56534
	Derecho	G52064
	Derecho Fab. hasta 6/01	G56533

SPORTAGE

05-10	Izquierdo	G56819	G56822	142535 ⁵³
	Derecho	G56820	G56821	142536 ⁵³
00-02	Izquierdo	G56787	143228 ⁵³	O	G63720
	Derecho	G56786	143228 ⁵³	O	G63720
95-99	Todos	G51227 ³⁷	143228 ⁵³	O	G63720

37 Reutilice o reemplace el tope de rebote del Equipo Original. No esta incluido con el amortiguador. Utilice el kit de montaje 142992 si los accesorios para montaje superior necesitan reemplazarse.

54 Kit con Montaje y Rodamiento. Es probable que reutilizar algunas partes del E.O.

53 Montaje de Strut. Es probable reutilizar algunas partes del E.O.

AMORTIGUADORES Y STRUTS

Año	Notas de Aplicación	Front					Rear				
		Ultra	ProGuard\ Guardian	LTV\ Max Control	Protector de Strut\ Bases de Strut	HiJacker\ Soporte\ Hidráulico	Ultra	ProGuard\ Guardian	LTV\ Max Control	Protector de Strut\ Bases de Strut	HiJacker\ Soporte\ Hidráulico

LAND ROVER

DISCOVERY

94-99	Exc. Series II	I	G63506	I	G63694
98	Todos		O	G63694

LAND ROVER

FREELANDER

02-05	Izquierdo		I	G52638
	Derecho		I	G52639

RANGE ROVER

03-08	Todos		I	G64074
94-95	Air(RearSpringType), Air(FrontSpringType)	I	G63615	O	G63694
95	County Classic, Exc. Suspensión con Nivelación Neumática	I	G63506	O	G63434
94	Coil(RearSpringType)		O	G63434
	County	I	G63506

LEXUS

ES250

90-91	Todos	I	G55590	143281 ⁵³	I	G55589
-------	-------	---	--------	------	------	----------------------	------	---	--------	------	------	------	------

ES300

03	Izquierdo Exc. Suspensión Adaptable Variable	I	G56673	143202 ⁵³	I	G56675
	Derecho Exc. Suspensión Adaptable Variable	I	G56674	143202 ⁵³	I	G56676
02	Izquierdo Exc. Suspensión Adaptable Variable	I	G56673	143202 ⁵³	I	G55675	142837 ⁵³
	Derecho Exc. Suspensión Adaptable Variable	I	G56674	143202 ⁵³	I	G55676	142837 ⁵³
97-01	Izquierdo Exc. Suspensión Adaptable Variable	I	G56506	142650 ⁵⁴	I	G55675	142837 ⁵³
	Derecho Exc. Suspensión Adaptable Variable	I	G56514	142649 ⁵⁴	I	G55676	142837 ⁵³
95-96	Todos	I	G56502	142836 ⁵⁴
	Izquierdo Exc. Suspensión Adaptable Variable	I	G56502	142836 ⁵⁴	I	G55675
	Derecho Exc. Suspensión Adaptable Variable	I	G56502	142836 ⁵⁴	I	G55676
92-94	Izquierdo Struts Sellados de EO		I	G55675
	Derecho Struts Sellados de EO		I	G55676
	Struts Sellados de EO	I	G55914

ES300 READYMOUNTS

		Delantero	Trasero
02-03	Izquierdo	G57041 ⁴⁰	G57043 ⁴⁰
	Derecho	G57042 ⁴⁰	G57044 ⁴⁰
02	Izquierdo Exc. Suspensión Adaptable Variable	G56932 ⁴⁰
	Derecho Exc. Suspensión Adaptable Variable	G56933 ⁴⁰
97-01	Izquierdo Exc. Suspensión Adaptable Variable	G56930 ⁴⁰	G56932 ⁴⁰
	Derecho Exc. Suspensión Adaptable Variable	G56931 ⁴⁰	G56933 ⁴⁰



40 Strut ReadyMount. Ensamble Completo

54 Kit con Montaje y Rodamiento. Es probable que reutilizar algunas partes del E.O.

53 Montaje de Strut. Es probable reutilizar algunas partes del E.O.

Texto en Negritas - Número de Parte Nuevo / Futuro

AMORTIGUADORES Y STRUTS

Año	Notas de Aplicación	Front					Rear				
			Ultra	ProGuard\ Guardian	LTV\ Max Control	Protector de Strut\ Bases de Strut	HiJacker\ Soporte\ Hidráulico		Ultra	ProGuard\ Guardian	LTV\ Max Control





LEXUS

LEXUS

ES300 READYMOUNTS (cont)

		Delantero	Trasero
92-96	Izquierdo Exc. Suspensión Adaptable Variable	G56932 ¹⁰
	Derecho Exc. Suspensión Adaptable Variable	G56933 ¹⁰

















ES330

04-06	Izquierdo Exc. Suspensión Adaptable Variable		G56721	143202 ⁵³		G56728
	Derecho Exc. Suspensión Adaptable Variable		G56722	143202 ⁵³		G56729





ES330 READYMOUNTS

		Delantero	Trasero
04-06	Izquierdo	G57078 ¹⁰
	Derecho	G57079 ¹⁰



ES350

12	Izquierdo			G52103
	Derecho			G52104
10-11	Izquierdo		143402		G52103
	Derecho		143402		G52104
07-11	Todos		143402	
	Mount Kit w/ Strut Mount, Bearing & 3 Nuts		143402	
07-09	Izquierdo		G56888	143402		G52103
	Derecho		G56889	143402		G52104



GS300

98-05	Todos		G56598	143200 ⁵³		G56599	143408 ⁵³
93-97	Todos		G56594	143200 ⁵³		G56595





GS400

98-00	Todos		G56598	143200 ⁵³		G56599	143408 ⁵³
-------	-------	---	--------	------	------	----------------------	------	---	--------	------	------	-----------------------------	------





GS430

01-05	Todos		G56598	143200 ⁵³		G56599	143408 ⁵³
-------	-------	---	--------	------	------	----------------------	------	---	--------	------	------	-----------------------------	------



IS250

06-11	Izquierdo		G51920		G51922
	Derecho		G51921		G51922

IS300

05	Todos			143408 ⁵³
01-04	Todos		G51834		G51835	143408 ⁵³

LS400

95-00	Exc. Sistema de Autonivelación			143198 ⁵³
-------	--------------------------------	---	------	------	------	------	------	---	------	------	------	----------------------	------

40 Strut ReadyMount. Ensemble Completo

53 Montaje de Strut. Es probable reutilizar algunas partes del E.O.

Texto en Negritas - Número de Parte Nuevo / Futuro

AMORTIGUADORES Y STRUTS

Año	Notas de Aplicación	Front					Rear				
		Ultra	ProGuard\ Guardian	LTV\ Max Control	Protector de Strut\ Bases de Strut	HiJacker\ Soporte\ Hidráulico	Ultra	ProGuard\ Guardian	LTV\ Max Control	Protector de Strut\ Bases de Strut	HiJacker\ Soporte\ Hidráulico

LEXUS

LEXUS

LS400 (cont)

95-00	Coil(RearSpringType)	↓	G56592	↓	G56600
90-94	Exc. Sistema de Autonivelación	↓	143199 ⁵³	↓	143197 ⁵³
	Coil(RearSpringType)	↓	G56592	↓	G56593

LS430

01-06	Todos	↓	G51832	↓	G51833
-------	-------	---	--------	------	------	------	------	---	--------	------	------	------	------

LX450

96-97	Todos	↓	G63615	↓	G63616
-------	-------	---	--------	------	------	------	------	---	--------	------	------	------	------

LX470

98-06	Barra de Torsion(FrontSpringType)	↓	G63832	↓	G63828
-------	-----------------------------------	---	--------	------	------	------	------	---	--------	------	------	------	------

RX300

99-03	Izquierdo	↓	G56548	142650 ⁵⁴	↓	142837 ⁵³
	Derecho	↓	G56547	142649 ⁵⁴	↓	142837 ⁵³
	AWD, Izquierdo	↓	↓	G56681
	AWD, Derecho	↓	↓	G56682
	FWD, Izquierdo	↓	↓	G56554
	FWD, Derecho	↓	↓	G56553

RX330

04-06	Todos	↓	143202 ⁵³	↓
	Izquierdo Exc. Suspensión de Aire	↓	G56730	143202 ⁵³	↓	143387
	Derecho Exc. Suspensión de Aire	↓	G56731	143202 ⁵³	↓	143388
	AWD, Izquierdo Exc. Suspensión de Aire	↓	143202 ⁵³	↓	G56732
	AWD, Derecho Exc. Suspensión de Aire	↓	143202 ⁵³	↓	G56733
	FWD, Izquierdo Exc. Suspensión de Aire	↓	143202 ⁵³	↓	G56734
	FWD, Derecho Exc. Suspensión de Aire	↓	143202 ⁵³	↓	G56735



RX350

11-15	Izquierdo w/o Air Suspensión	↓	G52447	↓
	Derecho w/o Air Suspensión	↓	G52448	↓
10	Todos	↓	↓	G64163
	Izquierdo w/o Air Suspensión	↓	G52447	↓	G64163
	Derecho w/o Air Suspensión	↓	G52448	↓	G64163
07-09	Izquierdo Exc. Suspensión de Aire	↓	G56730	↓	143387

53 Montaje de Strut. Es probable reutilizar algunas partes del E.O.

54 Kit con Montaje y Rodamiento. Es probable que reutilizar algunas partes del E.O.











AMORTIGUADORES Y STRUTS

Año	Notas de Aplicación	Front					Rear				
			Ultra	ProGuard\ Guardian	LTV\ Max Control	Protector de Strut\ Bases de Strut	HiJacker\ Soporte\ Hidráulico		Ultra	ProGuard\ Guardian	LTV\ Max Control









LEXUS

LEXUS



RX350 (cont)

07-09	Derecho Exc. Suspensión de Aire		G56731		143388
	FWD, Izquierdo Exc. Suspensión de Aire			G56734
	FWD, Derecho Exc. Suspensión de Aire			G56735
07	AWD, Izquierdo Exc. Suspensión de Aire			G56732
	AWD, Derecho Exc. Suspensión de Aire			G56733



RX400H

08	Izquierdo			143387
	Derecho			143388
06-07	Izquierdo		143202 ⁵³		143387
	Derecho		143202 ⁵³		143388





SC300

92-00	Todos		G51709		G51710
-------	-------	--	--------	------	------	------	------	--	--------	------	------	------	------

SC400

92-00	Todos		G51709		G51710
-------	-------	---	--------	------	------	------	------	---	--------	------	------	------	------



SC430

06-07	Todos		G56598	143200 ⁵³	
02-05	Todos		G56598	143200 ⁵³		G51995









LINCOLN

LINCOLN





AVIATOR

03-05	Todos		G51836		G51837
-------	-------	---	--------	------	------	------	------	---	--------	------	------	------	------



CONTINENTAL

82-87	Todos		G55510 ³⁹		69709 ⁹	81461	49196 ⁷
70-80	Todos		69675 ⁵	81446	34073 ⁸		69606	81495	43140 ⁸ 49205 ⁷
64-69	Todos		82615		82067
61-63	Todos		82615	

LS

05-06	Todos		143242 ⁵³		G51757	143242 ⁵³
00-04	Todos		G51756	143242 ⁵³		G51757	143242 ⁵³

MARK III

68-71	Todos		69675 ⁵	81446	34073 ⁸		69606	81495	43140 ⁸ 49205 ⁷
-------	-------	---	--------------------	-------	------	------	--------------------	---	-------	-------	------	------	--

5 Use el kit 140719 para reemplazar partes del EO de montaje inferior cuando los pernos se rompan o los tornillos autoroscantes no se puedan utilizar más.

8 Paquetes en pares



39 El strut de aire ajustable de EO puede reemplazarse con un strut convencional. Sin embargo, el sistema de autonivelación debe desactivarse. Vea Ref. A.

7 Paquetes en pares; kit de mangueras de aire incluido

9 Vea Ref.D para los procedimientos de reemplazo de una Susp. Elect. Ajust. con un producto no ajust.





53 Montaje de Strut. Es probable reutilizar algunas partes del E.O.

AMORTIGUADORES Y STRUTS

Año	Notas de Aplicación	From					Rear				
			Ultra	ProGuard\ Guardian	LTV\ Max Control	Protector de Strut\ Bases de Strut	HiJacker\ Soporte\ Hidráulico		Ultra	ProGuard\ Guardian	LTV\ Max Control













LINCOLN

MARK IV

73-76	Todos		69675 ⁵	81446	34073 ⁸		82603
72	Todos		69675 ⁵	81446	34073 ⁸		69606	81495	43140 ⁸ 49205 ⁷

LINCOLN



MARK LT

09-12	Todos			G64079
	AWD		G51864		G64079
	RWD		G51865		G64079
06-08	Todos		143248 ⁵³	
	4WD		G51704	143248 ⁵³		G63867
	RWD		G51703	143248 ⁵³		G63870

MARK LT READYMOUNTS

				Delantero		Trasero	
06-08	4WD			G57020 ⁴⁰		
	RWD			G57021 ⁴⁰		



MARK V

77-79	Todos		69675 ⁵	81446	34073 ⁸		82603
-------	-------	--	--------------------	-------	------	------	--------------------	--	------	-------	------	------	------





MARK VI

80-83	Todos		69675 ⁵	81446	34073 ⁸		69606	81495	43140 ⁸ 49205 ⁷
-------	-------	---	--------------------	-------	------	------	--------------------	---	-------	-------	------	------	--







MARK VII

84-92	Todos		G55510 ³⁹		69709 ⁹	81461
-------	-------	---	----------------------	------	------	------	------	---	--------------------	-------	------	------	------









MKS

09-12	Izquierdo w/ Suspensión Code A y B		G52398	
	Derecho w/ Suspensión Code A y B		G52399	

MKT

13-16	Todos			G51996
10-12	Izquierdo		G52384		G51996
	Derecho		G52385		G51996

MKX

11-14	Izquierdo		G52351		G64111
	Derecho		G52352		G64111
10	Izquierdo		G56840	
	Derecho		G56841	

5 Use el kit 140719 para reemplazar partes del EO de montaje inferior cuando los pernos se rompan o los tornillos autoroscantes no se puedan utilizar más.

8 Paquetes en pares

39 El strut de aire ajustable de EO puede reemplazarse con un strut convencional.

Sin embargo, el sistema de autonivelación debe desactivarse. Vea Ref. A.

53 Montaje de Strut. Es probable reutilizar algunas partes del E.O.





Texto en Negritas - Número de Parte Nuevo / Futuro

7 Paquetes en pares; kit de mangueras de aire incluido

9 Vea Ref.D para los procedimientos de reemplazo de una Susp. Elect. Ajust. con un producto no ajust.

40 Strut ReadyMount. Ensamble Completo





AMORTIGUADORES Y STRUTS

Año	Notas de Aplicación										
			ProGuard\ Guardian	LTV\ Max Control	Protector de Strut\ Bases de Strut	HiJacker\ Soporte\ Hidráulico		ProGuard\ Guardian	LTV\ Max Control	Protector de Strut\ Bases de Strut	HiJacker\ Soporte\ Hidráulico











LINCOLN

LINCOLN





































MKX (cont)

07-09	Izquierdo		G56840	143415		G64037
	Derecho		G56841	143415		G64037

MKZ

10-12	Izquierdo		G51896	143392⁵³	
	Derecho		G51897	143392⁵³	
	FWD			69591
07-09	Todos		G51859	143392⁵³	
	FWD		G51859	143392⁵³		69591

NAVIGATOR

14-16	Todos			G51861
	4WD, RWD		143424⁵³		G51861
	4WD, RWD, Exc. Suspensión de Aire			G51861	143393⁵³
11-13	Todos		G51860		G51861
	4WD, RWD		G51860	143424⁵³		G51861
	4WD, RWD, Exc. Suspensión de Aire		G51860		G51861	143393⁵³
10	Todos		G51860	143424⁵³		G51861
	4WD, RWD, Exc. Suspensión de Aire		G51860	143424⁵³		G51861	143393⁵³
07-09	Todos		G51860	143376 143424⁵³		G51861
	RWD		G51860	143376 143424⁵³		G51861	143393
03-06	Todos		143244 ⁵³	
	Exc. Suspensión Neumática		143244 ⁵³		G51729
	4WD, Exc. Suspensión neumática		G51720	143244 ⁵³	
	RWD		G51719	143244 ⁵³	
98-02	4WD, Air(RearSpringType)			G64002	61703
	Coil(FrontSpringType)		61611	
	RWD		G63714	81912	58714 77714		G63717	61614	77717
	RWD, Coil(FrontSpringType)			58717

53 Montaje de Strut. Es probable reutilizar algunas partes del E.O.

Texto en Negritas - Número de Parte Nuevo / Futuro

AMORTIGUADORES Y STRUTS

Año	Notas de Aplicación	From					Rear				
		Ultra	ProGuard\ Guardian	LTV\ Max Control	Protector de Strut\ Bases de Strut	HiJacker\ Soporte\ Hidráulico	Ultra	ProGuard\ Guardian	LTV\ Max Control	Protector de Strut\ Bases de Strut	HiJacker\ Soporte\ Hidráulico

LINCOLN

LINCOLN

NAVIGATOR READYMOUNTS

		Delantero	Trasero
14-16	4WD, RWD, Exc. Suspensión de Aire	G57173 ⁴⁰
10-13	Todos	G57172 ⁴⁰
	4WD, RWD, Exc. Suspensión de Aire	G57172 ⁴⁰	G57173 ⁴⁰
03-06	Todos	G57016 ⁴⁰
	4WD	G57015	G57016 ⁴⁰

TOWN CAR

03-11	Todos	77955
	Modelo Limo	G51888	69574	77955
	Exc. Limo	G51887	77955
	Exc. Modelo Limo	143356 ⁵³ 143357 ⁶⁸	69575	77955
81-02	Todos	69675 ⁵	81446	69606	81495
										43140 ⁸ 49205 ⁷

TOWN CAR READYMOUNTS

		Delantero	Trasero
03-11	Exc. Limo	G57080 ⁴⁰

VERSAILLES

77-80	Todos	81491	82130
-------	-------	------	-------	------	------	------	------	------	-------	------	------	------

ZEPHYR

06	Todos	G51859	143392 ⁵³	69591
----	-------	--------	------	------	-----------------------------	------	------	-------	------	------	------	------

MAZDA

MAZDA

2

12-14	Todos	70052
11	Izquierdo	G52255	143399	70052	143400 ⁵³
	Derecho	G52256	143399	70052	143400 ⁵³

3

12-13	Izquierdo	G52449	G51983
	Derecho	G52450	G51983
13	Exc. Modelo Mazdaspeed Izquierdo	G52005
	Exc. Modelo Mazdaspeed Derecho	G52006
10-12	Exc. Modelo Mazdaspeed Izquierdo	G52005	143365 ⁵³
	Exc. Modelo Mazdaspeed Derecho	G52006	143365 ⁵³
10-11	Izquierdo	G52449	G51983	143531 ⁵³
	Derecho	G52450	G51983	143531 ⁵³
07-09	Izquierdo	G52449	143531 ⁵³

5 Use el kit 140719 para reemplazar partes del EO de montaje inferior cuando los pernos se rompan o los tornillos autoroscantes no se puedan utilizar más.

8 Paquetes en pares

53 Montaje de Strut. Es probable reutilizar algunas partes del E.O.



Texto en Negritas - Número de Parte Nuevo / Futuro

7 Paquetes en pares; kit de mangueras de aire incluido

40 Strut ReadyMount. Ensamble Completo

68 Kit de Accesorios de Montajet. Aislador de Goma del Asiento de Resorte. Es probable reutilizar algunas partes del E.O.













AMORTIGUADORES Y STRUTS

Año	Notas de Aplicación	Front					Rear				
			Ultra	ProGuard\ Guardian	LTV\ Max Control	Protector de Strut\ Bases de Strut	HiJacker\ Soporte\ Hidráulico		Ultra	ProGuard\ Guardian	LTV\ Max Control

MAZDA

MAZDA









3 (cont)

07-09	Derecho		G52450		143531 ⁵³
	Exc. Modelo Mazdaspeed Izquierdo		G52005	143365 ⁵³		70003
	Exc. Modelo Mazdaspeed Derecho		G52006	143365 ⁵³		70003
04-06	Todos			70003	143531 ⁵³
	Exc. Modelo Mazdaspeed Izquierdo		G52005	143365 ⁵³		70003	143531 ⁵³
	Exc. Modelo Mazdaspeed Derecho		G52006	143365 ⁵³		70003	143531 ⁵³

3 READYMOUNTS

		Delantero	Trasero
04-13	Exc. Modelo Mazdaspeed Derecho	G57094 ⁴⁰
13	Exc. Modelo Mazdaspeed Izquierdo	G57093
04-12	Exc. Modelo Mazdaspeed Izquierdo	G57093 ⁴⁰



















5

12-13	Izquierdo		G52519		G511040
	Derecho		G52520		G511040
06-10	Izquierdo		G52005	143365 ⁵³		70003	143531 ⁵³
	Derecho		G52006	143365 ⁵³		70003	143531 ⁵³







5 READYMOUNTS

		Delantero	Trasero
06-10	Izquierdo	G57093 ⁴⁰
	Derecho	G57094 ⁴⁰

6

14-15	Todos			70110
12-13	Izquierdo		G51984		70110
	Derecho		G51985		70110
09-11	Izquierdo		G51984	
	Derecho		G51985	
05-08	Izquierdo		G51810	143392 ⁵³		69591
	Derecho		G51811	143392 ⁵³		69591
03-04	Izquierdo		G51810	143224 ⁵³		69591
	Derecho		G51811	143224 ⁵³		69591

323

90-94	Todos		G55847		G55848	142190 ⁵³
86-89	Exc. Suspensión Electrónica Ajustable		142183 ⁵³	
	FWD, Exc. Suspensión Electrónica Ajustable		G55710		G55544

40 Strut ReadyMount. Ensemble Completo

53 Montaje de Strut. Es probable reutilizar algunas partes del E.O.

Texto en Negritas - Número de Parte Nuevo / Futuro

AMORTIGUADORES Y STRUTS

Año	Notas de Aplicación	Front					Rear				
		Ultra	ProGuard\ Guardian	LTV\ Max Control	Protector de Strut\ Bases de Strut	HiJacker\ Soporte\ Hidráulico	Ultra	ProGuard\ Guardian	LTV\ Max Control	Protector de Strut\ Bases de Strut	HiJacker\ Soporte\ Hidráulico















MAZDA

MAZDA

323 READYMOUNTS

			Delantero	Trasero
95	Todos		G56940 ⁴⁰
91-94	Todos		G56911 ⁴⁰	G56940 ⁴⁰
90	Todos		G56911 ⁴⁰





626

98-02	Izquierdo	 G56689	143218 ⁵³	 G56691
	Derecho	 G56690	143218 ⁵³	 G56691	143112 ⁵³
93-97	Izquierdo	 G55671	142856 ⁵⁴	 G55672
	Derecho	 G55670	142856 ⁵⁴	 G55672
88-92	Exc. Suspensión Electrónica Ajustable o con dirección en las 4 ruedas	 G55600 ⁹	 G55601 ⁹	142196 ⁵³
	Automatic Exc. Suspensión Electrónica Ajustable o con dirección en las 4 ruedas		142562 ⁵⁸	
83-87	Exc. Suspensión Electrónica Ajustable	 G55727	 G55729

808

72-77	Wagon Exc. Vehículos c/ Stuts Tokico de EO			81270
-------	--	---	------	------	------	------	---	-------	------	------	------



929

90-91	Exc. Suspensión Electrónica Ajustable	 G56716	 G51192 ⁹
88-89	Exc. Suspensión Electrónica Ajustable	 G56713	142562 ⁵⁸	 G51192 ⁹







B1600

72-76	Todos	 G63421	61504 81750	58421 77421		82125
-------	-------	--	----------------	----------------	------	------	---	-------	------	------	------







B1800

77-78	Todos	 G63421	61504 81750	58421 77421		82125
-------	-------	--	----------------	----------------	------	------	---	-------	------	------	------



B2000

86-87	RWD	 G63495	61593 81553	 G63907	61500 81147	77907	43048 ⁸ 49310 ⁷
	RWD			70163
79-84	Todos	 G63421	61504 81750	58421 77421		82125

B2200

87-93	RWD	 G63495	61593 81553	 G63907	61500 81147	77907	43048 ⁸ 49310 ⁷
	RWD			70163
82-84	Todos	 G63421	61504 81750	58421 77421		82125

B2300

01-06	RWD	 G63772	61626 81916	77772	 G63773	61627	77525
-------	-----	--	----------------	-------	------	------	--	-------	-------	------	------

7 Paquetes en pares; kit de mangueras de aire incluido

9 Vea Ref.D para los procedimientos de reemplazo de una Susp. Elect. Ajust. con un producto no ajust.

53 Montaje de Strut. Es probable reutilizar algunas partes del E.O.

58 El Kit de Montaje incluye: Rodamiento de Suspensión. Es probable reutilizar algunas partes del E.O.



Texto en Negritas - Número de Parte Nuevo / Futuro

8 Paquetes en pares

40 Strut ReadyMount. Ensemble Completo

54 Kit con Montaje y Rodamiento. Es probable que reutilizar algunas partes del E.O.





AMORTIGUADORES Y STRUTS

Año	Notas de Aplicación	Front					Rear				
			Ultra	ProGuard\ Guardian	LTV\ Max Control	Protector de Strut\ Bases de Strut	HiJacker\ Soporte\ Hidráulico		Ultra	ProGuard\ Guardian	LTV\ Max Control





MAZDA

MAZDA







B2300 (cont)

94-97	Todos		G63614	61561 81744	58929 77614	
	RWD		G63614	61561 81744	58929 77614		G63525	61559 81730	77525	49223 ⁷
95-96	4WD		G63614	61561 81744	58929 77614		G63524	61573 81905	77524





















B2500

98-01	Todos			81917
	RWD		G63772	61626 81916	77772		G63773	61627 81917	77525

















B2600

87-93	4WD		G63635	61596		G63639	61597
	RWD		G63495	61593 81553		G63907	61500 81147	77907	43048 ⁸ 49310 ⁷
	RWD			70163







B3000

98-08	Todos			43185
98-06	4WD		G63678	61623 81893	77678		G63775	61629 81918	77524	43185
	RWD		G63772	61626 81916	77772		G63773	61627 81917	77525	43185
96-97	RWD		G63614	61561 81744	77614		G63525	61559 81730	77525	43185
94-97	Todos		G63614	61561 81744		43185
	4WD		G63614	61561 81744		G63524	81905	43185
96	4WD, RWD		G63614	81744 61561		43185
95	RWD		G63614	81744 61561	77614		G63525	61559 81730	77525	43185
94	4WD, RWD		G63614	81744 61561		43185
	RWD		G63614	61561 81744	77614		G63525	61559 81730	77525	43185

B4000

98-08	Todos			43185
05-06	4WD		G63678	61623 81893	77678		G63775	61629 81918	77524	43185
98-06	RWD		G63772	61626 81916	77772		G63773	61627 81917	77525	43185
98-04	4WD		G63678	61623 81893	77678		G63775	61629 81918	77524	43185
95-97	RWD		G63614	61561 81744	77614		G63525	77525	43185
94-97	Todos		G63614	81744		43185
	4WD		G63614	81744		G63524	81905	43185
94	RWD		G63614	61561 81744	77614		G63525	61559	77525	43185



CX-7

11-12	Todos			G64056
07-10	Derecho		G52210		G64056
06-10	Izquierdo		G52209		G64056

7 Paquetes en pares; kit de mangueras de aire incluido

8 Paquetes en pares

AMORTIGUADORES Y STRUTS

Año	Notas de Aplicación										
		Ultra	ProGuard\ Guardian	LTV\ Max Control	Protector de Strut\ Bases de Strut	HiJacker\ Soporte\ Hidráulico	Ultra	ProGuard\ Guardian	LTV\ Max Control	Protector de Strut\ Bases de Strut	HiJacker\ Soporte\ Hidráulico

MAZDA

MAZDA

CX-7 (cont)

06	Todos	○ G64056
----	-------	-------	-------	-------	-------	-------	----------	-------	-------	-------	-------

CX-9

07-13	Izquierdo	↓ G52260	↓ G64072
	Derecho	↓ G52261	↓ G64072

GLC

84-85	Todos	↓ G55710
	Hatchback	↓ G55710	142183 ⁵³	↓ G55544
81-85	Sedan	↓ G55710	142183 ⁵³	↓ G55544
79-83	Wagon	↑ T	81270	49105 ⁷
83	Hatchback	↓	142183 ⁵³	↓ G55544
81-82	Hatchback	↓ G55710	142183 ⁵³	↓ G55544
78	Todos	↑ T	81270	49105 ⁷

MIATA

04-05	Base, LS	↓ G56596	↓ G56597
03	Base, LS, SE	↓ G56596	↓ G56597
99-02	Todos	↓ G56596	↓ G56597
90-97	Non-ABS	↓ G51195	142237 ⁵⁴	↓ G51196	142237 ⁵⁴

MILLENNIA

97-02	Izquierdo	↓ G51827	↓ G51826
	Derecho	↓ G51828	↓ G51826
95-96	Todos	↓ G51826

MPV

01-06	Izquierdo	↓ G56625	142562 ⁵⁸ 143267 ⁵³	○ 69782 ○ G63864
	Derecho	↓ G56624	142562 ⁵⁸ 143267 ⁵³	○ 69782 ○ G63864
00	Todos	↓	142562 ⁵⁸ 143267 ⁵³	○ 69782 ○ G63864
	Izquierdo Fab. desde 8/00	↓ G56625	142562 ⁵⁸ 143267 ⁵³	○ 69782 ○ G63864
	Izquierdo Fab. hasta 8/00	↓ G56589	142562 ⁵⁸ 143267 ⁵³	○ 69782 ○ G63864
	Derecho Fab. desde 8/00	↓ G56624	142562 ⁵⁸ 143267 ⁵³	○ 69782 ○ G63864
	Derecho Fab. hasta 8/00	↓ G56588	142562 ⁵⁸ 143267 ⁵³	○ 69782 ○ G63864
	Derecho Fab. hasta 8/00	↓ G56588	142562 ⁵⁸ 143267 ⁵³	○ 69782 ○ G63864





7 Paquetes en pares; kit de mangueras de aire incluido

54 Kit con Montaje y Rodamiento. Es probable que reutilizar algunas partes del E.O.

53 Montaje de Strut. Es probable reutilizar algunas partes del E.O.

58 El Kit de Montaje incluye: Rodamiento de Suspensión. Es probable reutilizar algunas partes del E.O.









AMORTIGUADORES Y STRUTS

Año	Notas de Aplicación										
			Ultra	ProGuard\ Guardian	LTV\ Max Control	Protector de Strut\ Bases de Strut	HiJacker\ Soporte\ Hidráulico		Ultra	ProGuard\ Guardian	LTV\ Max Control



MAZDA

MAZDA



MPV (cont)

95-98	4WD		G56715		G63640	61598
89-98	RWD		G56714		G63606	61589	49229 ⁷
89-94	4WD			G63640	61598
	Exc. Sistema de Autonivelación NIVOMAT		G56715	



MX-3

92-95	Non-ABS		G55847		G55848
-------	---------	---	--------	------	------	------	------	---	--------	------	------	------	------









MX-5

06-08	Todos		G51906		G51907
-------	-------	---	--------	------	------	------	------	---	--------	------	------	------	------

MX-5 MIATA

06-08	Todos		G51906	143412 ⁵³		G51907	143412 ⁵³
-------	-------	---	--------	------	------	----------------------	------	---	--------	------	------	----------------------	------

MX6

93-97	Izquierdo		G55671	142856 ⁵⁴		G55672
	Derecho		G55670	142856 ⁵⁴		G55672
88-92	Exc. Suspensión Electrónica Ajustable o con dirección en las 4 ruedas		G55600 ⁹		G55601 ⁹	142196 ⁵³
	Automatic Exc. Suspensión Electrónica Ajustable o con dirección en las 4 ruedas		142562 ⁵⁸	



















NAVAJO

91-94	Todos		G63608	61591 81744	58929 77608	34076 ⁸		G63607	61590 81823	77607	43172 ⁸ 49225 ⁷
-------	-------	---	--------	----------------	----------------	------	--------------------	---	--------	----------------	-------	------	--

NAVAJO ESTABILIZADORES DE DIRECCIÓN

91-94	Todos									Delantero	Trasero		
										6802SE ⁸⁴		

PROTÉGÉ / PROTÉGÉS

03	Izquierdo			G56538	143221 ⁵³
	Izquierdo Fab. desde 10/00		G56634	
	Derecho			G56537	143223 ⁵³
	Derecho Fab. desde 10/00		G56633	
	DX, ES, LX, SE, Izquierdo		143219 ⁵³		143221 ⁵³
	DX, ES, LX, SE, Derecho		143219 ⁵³		143223 ⁵³
	Exc. Modelos MP3 y Mazdaspeed Izquierdo			G56538
Exc. Modelos MP3 y Mazdaspeed Derecho			G56537
01-02	Exc. Modelos MP3 y Mazdaspeed Izquierdo		143219 ⁵³		G56538

7 Paquetes en pares; kit de mangueras de aire incluido

9 Vea Ref.D para los procedimientos de reemplazo de una Susp. Elect. Ajust. con un producto no ajust.

54 Kit con Montaje y Rodamiento. Es probable que reutilizar algunas partes del E.O.

84 Amortiguador de repuesto para los vehículos con el kit de montaje aftermarket GRC



8 Paquetes en pares

53 Montaje de Strut. Es probable reutilizar algunas partes del E.O.

58 El Kit de Montaje incluye: Rodamiento de Suspensión. Es probable reutilizar algunas partes del E.O.

Texto en Negritas - Número de Parte Nuevo / Futuro

AMORTIGUADORES Y STRUTS

Año	Notas de Aplicación	From 					Rear 				
		Ultra	ProGuard\ Guardian	LTV\ Max Control	Protector de Strut\ Bases de Strut	HiJacker\ Soporte\ Hidráulico	Ultra	ProGuard\ Guardian	LTV\ Max Control	Protector de Strut\ Bases de Strut	HiJacker\ Soporte\ Hidráulico

MAZDA

MAZDA

PROTÉGÉ / PROTÉGÉ5 (cont)

01-02	Exc. Modelos MP3 y Mazdaspeed Derecho	143219 ⁵³	G56537
00-02	Izquierdo Fab. desde 10/00	G56634	143219 ⁵³
	Derecho Fab. desde 10/00	G56633	143219 ⁵³
99-02	Todos	143219 ⁵³
02	Izquierdo	143219 ⁵³	G56538	143221 ⁵³
	Derecho	143219 ⁵³	G56537	143223 ⁵³
01	Izquierdo	143219 ⁵³	143221 ⁵³
	Derecho	143219 ⁵³	143223 ⁵³
99-00	Izquierdo	143219 ⁵³	G56538	143221 ⁵³
	Izquierdo Fab. hasta 10/00	G56536	143219 ⁵³
	Derecho	143219 ⁵³	G56537	143223 ⁵³
	Derecho Fab. hasta 10/00	G56535	143219 ⁵³
95-98	Izquierdo	G55882	142851 ⁵⁴	G55884
	Derecho	G55881	142851 ⁵⁴	G55883
90-94	FWD, Non-ABS	G55847	G55848	142190 ⁵³

PROTÉGÉ / PROTÉGÉ5 READYMOUNTS

							Delantero	Trasero				
90-94	Todos						G56911 ⁴⁰	G56940 ⁴⁰				

RX3

75-76	Wagon	81270
	Wagon Exc. Modelos c/ Struts Tokico de EO	49105 ⁷
74	Todos	49105 ⁷
	Wagon	81270	49105 ⁷
72-73	Todos	81270	49105 ⁷

RX4

74-78	Todos	81270	49105 ⁷
-------	-------	-------	-------	-------	-------	-------	-------	-------	-------	-------	--------------------

RX7

86-91	Exc. Suspensión Electrónica Ajustable	G55542 ⁹	G51031 ⁹
81-85	GS, S	G44735 ⁹⁸	69674
79-85	Todos	69674

7 Paquetes en pares; kit de mangueras de aire incluido
 40 Strut ReadyMount. Ensamble Completo
 54 Kit con Montaje y Rodamiento. Es probable que reutilizar algunas partes del E.O.



9 Vea Ref.D para los procedimientos de reemplazo de una Susp. Elect. Ajust. con un producto no ajust.

53 Montaje de Strut. Es probable reutilizar algunas partes del E.O.

98 Nota: El nivel de dificultad para instalar este producto es moderadamente alto. Por favor revise las instrucciones cuidadosamente antes de comenzar.

Texto en Negritas - Número de Parte Nuevo / Futuro

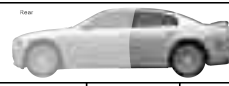

AMORTIGUADORES Y STRUTS

Año	Notas de Aplicación	Front					Rear				
			Ultra	ProGuard\ Guardian	LTV\ Max Control	Protector de Strut\ Bases de Strut	HiJacker\ Soporte\ Hidráulico		Ultra	ProGuard\ Guardian	LTV\ Max Control
											









MAZDA

MAZDA

RX8

04-08	Todos		G51923		G51924
-------	-------	---	--------	------	------	------	------	---	--------	------	------	------	------

TRIBUTE

08-11	Izquierdo		G56601	143253 ⁵³		G64047
	Derecho		G56568	143253 ⁵³		G64047
01-06	Izquierdo		G56601	143253 ⁵³		69900 G63862
	Derecho		G56568	143253 ⁵³		69900 G63862



TRIBUTE READYMOUNTS

		Delantero		Trasero	
08-11	Izquierdo	G57045 ⁴⁰		
	Derecho	G57046 ⁴⁰		
01-06	Izquierdo	G57045 ⁴⁰		
	Derecho	G57046 ⁴⁰		



MERCEDES-BENZ

MERCEDES-BENZ

190D

84-89	Todos		G55527	142326 ⁵³		69995
-------	-------	--	--------	------	------	----------------------	------	--	-------	------	------	------	------



190E

84-93	Todos		G55527	142326 ⁵³		69995
-------	-------	---	--------	------	------	----------------------	------	---	-------	------	------	------	------





190SL

62-63	Todos			82069
-------	-------	--	------	------	------	------	------	---	------	-------	------	------	------









200D

69-73	Todos			69766
68	Todos		69661		69766



220 / 220D

69-73	Todos			69766
	W115		69661		69766
68	Todos		69661		69766



230

77-78	Exc. W115		69996		69766
74-78	Todos			69766
74-76	W115		69661		69766
68-69	Todos			69766
69	W115		69661		69766

230E

91	2.3L 4Cyl (140) RWD; 1BBL			69995
86-89	2.3L 4Cyl (140) RWD; 1BBL			69995

240D

76-83	W123		69996		69766
74-83	Todos			69766

40 Strut ReadyMount. Ensemble Completo

53 Montaje de Strut. Es probable reutilizar algunas partes del E.O.

Texto en Negritas - Número de Parte Nuevo / Futuro

AMORTIGUADORES Y STRUTS

Año	Notas de Aplicación	From					Rear				
		Ultra	ProGuard\ Guardian	LTV\ Max Control	Protector de Strut\ Bases de Strut	HiJacker\ Soporte\ Hidráulico	Ultra	ProGuard\ Guardian	LTV\ Max Control	Protector de Strut\ Bases de Strut	HiJacker\ Soporte\ Hidráulico

MERCEDES-BENZ

240D (cont)

74-76	W115	69661	69766
-------	------	-------	-----	-----	-----	-----	-------	-----	-----	-----	-----

250

68-70	Todos	69766
-------	-------	-----	-----	-----	-----	-----	-------	-----	-----	-----	-----

250D

86	2.5L 5Cyl (152) RWD; 2BBL	69995
----	---------------------------	-----	-----	-----	-----	-----	-------	-----	-----	-----	-----

260E

92	2.6L 6Cyl (158) RWD; 2BBL	69995
87-89	4 Matic	69995
	Exc. 4 Matic 4WD	G55527	142326 ⁵³
	Exc. Suspensión Hydromat	69996	69766

260SE

89	2.6L 6Cyl (158) RWD; 2BBL	69996
87	2.6L 6Cyl (158) RWD; 2BBL	69996

280

76	Todos	69996	69766
----	-------	-------	-----	-----	-----	-----	-------	-----	-----	-----	-----

280C

73-76	Todos	69766
	W115	69661	69766
76	Exc. W115	69996	69766

280CE / 280E / 280S / 280SE / 280SEL





77-81	Todos	69996	69766
75-80	Exc. Suspensión Hydromat	69996	69766
73	Exc. Suspensión Hydromat	69996	69766
72	Fab. desde Sep/72, Exc. Suspensión Hydromat	69996	69766

300D

90-93	Exc. 4 Matic 4WD	G55527	142326 ⁵³
	W115 4 Matic	69995
89	3L 6Cyl (182) RWD; 2BBL	69995
87	Exc. 4 Matic 4WD	G55527
	W115 4 Matic	69995
86	3L 5Cyl (182) RWD; 2BBL	69995
85	W115 4 Matic	69995
77-84	Todos	69996
76-84	W123	69996	69766
84	W115 4 Matic	69996	69995
76	W115	69661
75	Todos	69661
	W123	69661	69766





53 Montaje de Strut. Es probable reutilizar algunas partes del E.O.

AMORTIGUADORES Y STRUTS









Año	Notas de Aplicación										
			Ultra	ProGuard\ Guardian	LTV\ Max Control	Protector de Strut\ Bases de Strut	HiJacker\ Soporte\ Hidráulico		Ultra	ProGuard\ Guardian	LTV\ Max Control

MERCEDES-BENZ





300E

86-93	Todos			69995
	Exc. 4 Matic 4WD		G55527	142326 ⁵³		69995







300SD / 300SDL / 300SE / 300SEL / 300TD / 350SD / 350SDL / 350SL / 380SE / 380SEC / 380SEL

78-91	Exc. Suspensión Hydromat		69996		69766
86	3L 6Cyl (180) RWD; 2BBL		69661		69766
79-85	Todos		69996	
72	Todos		69661		69766



380SL / 380SLC

85	Todos			69766
81-84	Todos		69661		69766



400E / 400SE / 400SEL / 420SEL / 450SE / 450SEL

92-93	Todos		G55527	142326 ⁵³	
86-91	Exc. Suspensión Hydromat		69996		69766
73-80	Exc. Suspensión Hydromat		69996		69766



420SE

86	4.2L 8Cyl (256) 4BBL			69766
----	----------------------	---	-------	-------	-------	-------	-------	---	-------	-------	-------	-------	-------



420SL

86	4.2L 8Cyl (256) 4BBL		69661		69766
----	----------------------	---	-------	-------	-------	-------	-------	---	-------	-------	-------	-------	-------







450SL / 450SLC

74-80	Todos		69661		69766
-------	-------	---	-------	-------	-------	-------	-------	---	-------	-------	-------	-------	-------







500SE

86	5L 8Cyl (303) FI		69996		69766
----	------------------	---	-------	-------	-------	-------	-------	---	-------	-------	-------	-------	-------



500SEC / 500SEL / 500SEC / 560SEC / 560SEL

84-91	Exc. Suspensión Hydromat		69996		69766
91	5L 8Cyl (303) FI		69996		69766
87	5L 8Cyl (303) FI		69996		69766



500SL

90-93	Todos		142326 ⁵³	
89	5L 8Cyl (303) FI		69661		69766
86	5L 8Cyl (303) FI		69661		69766



600SL

93	Todos		142326 ⁵³	
----	-------	---	-------	-------	-------	----------------------	-------	---	-------	-------	-------	-------	-------

B CLASS B200

06-11	200 Turbo			70101
-------	-----------	---	-------	-------	-------	-------	-------	---	-------	-------	-------	-------	-------

C220

94-96	Todos		69877		69878
-------	-------	---	-------	-------	-------	-------	-------	---	-------	-------	-------	-------	-------

53 Montaje de Strut. Es probable reutilizar algunas partes del E.O.

AMORTIGUADORES Y STRUTS

Año	Notas de Aplicación	Front					Rear				
		Ultra	ProGuard\ Guardian	LTV\ Max Control	Protector de Strut\ Bases de Strut	HiJacker\ Soporte\ Hidráulico	Ultra	ProGuard\ Guardian	LTV\ Max Control	Protector de Strut\ Bases de Strut	HiJacker\ Soporte\ Hidráulico

MERCEDES-BENZ

C230

06-07	Exc. Suspensión Deportiva	G56791	70033
	Suspensión Deportiva	G56792	70033
02-07	Todos	70033
02-05	Coupe Exc. Suspensión Deportiva	G56791	70033
	Coupe Suspensión Deportiva	G56792	70033
97-00	Todos	69877	69878

MERCEDES-BENZ

C240

04-05	RWD, Suspensión Deportiva	G56792
01-05	RWD	70033
	RWD, Exc. Suspensión Deportiva	G56791
01-03	Suspensión Deportiva	G56792

C250

12	CGI(FuelDelSubType), Sedan	G52172	70038
10-11	Todos	G52172	70038

C280

08-09	Todos	G52172	70038
06-07	RWD	70033
	RWD, Exc. Suspensión Deportiva	G56791
	RWD, Suspensión Deportiva	G56792
94-00	Todos	69877	69878

C300

11	Todos	G52172	70038
10	Todos	70038
	Exc. 4-Matic Models	G52172	70038
08-09	Todos	G52172	70038



C320

01-05	RWD	70033
	RWD, Suspensión Deportiva	G56792
	RWD, Sedan Exc. Suspensión Deportiva	G56791
02-04	RWD, Wagon Exc. Suspensión Deportiva	G56791

C350



12	CGI(FuelDelSubType)	G52172	70038
08-11	Todos	G52172	70038

AMORTIGUADORES Y STRUTS

Año	Notas de Aplicación	Front					Rear				
			Ultra	ProGuard\ Guardian	LTV\ Max Control	Protector de Strut\ Bases de Strut	HiJacker\ Soporte\ Hidráulico		Ultra	ProGuard\ Guardian	LTV\ Max Control









MERCEDES-BENZ

C350 (cont)



06-07	Exc. Suspensión Deportiva		G56791
	Suspensión Deportiva		G56792
	RWD	

MERCEDES-BENZ







CLK320

04-05	Todos	
	Exc. Suspensión Deportiva		G56791
	Suspensión Deportiva		G56792
03	Todos		70064
	Exc. Suspensión Deportiva		G56791
	Suspensión Deportiva		G56792
98-02	Todos		70064
02	Exc. Suspensión Deportiva		G56791
	Suspensión Deportiva		G56792



CLK350

06-09	Todos	
	Exc. Suspensión Deportiva		G56791
	Suspensión Deportiva		G56792



CLK430

03	Todos	
	Exc. Suspensión Deportiva		G56791
	Suspensión Deportiva		G56792
99-02	Todos		70064
02	Exc. Suspensión Deportiva		G56791
	Fab. desde 4/02		70064
	Suspensión Deportiva		G56792

CLK500

03-06	Todos	
	Exc. Suspensión Deportiva		G56791
	Suspensión Deportiva		G56792

CLK550

07-09	Todos	
	Coupe Exc. Suspensión Deportiva		G56791

E200

12-13	Todos	
-------	-------	---	------	------	------	------	------	------	------	------	------	------

AMORTIGUADORES Y STRUTS

Año	Notas de Aplicación	Front					Rear				
		Ultra	ProGuard\ Guardian	LTV\ Max Control	Protector de Strut\ Bases de Strut	HiJacker\ Soporte\ Hidráulico	Ultra	ProGuard\ Guardian	LTV\ Max Control	Protector de Strut\ Bases de Strut	HiJacker\ Soporte\ Hidráulico

MERCEDES-BENZ

E250

11-13	Todos	↓ G511041
-------	-------	-------	-------	-------	-------	-------	-----------	-------	-------	-------	-------

E300

11-13	Todos	↓ G511041
99	Exc. 4 Matic	↓ 69966
	Exc. Suspensión Deportiva	○ 69952
96-98	Todos	↓ 69966
	Exc. Suspensión Deportiva	○ 69952	↓ 69966
95	Todos	↓ G55527	142326 ⁵³

E320

98-06	Exc. 4 Matic	143086 ⁵³
96-02	Sedan	↓ 69966
	Sedan Exc. Suspensión Deportiva	○ 69952
96-97	Exc. 4 Matic	143086
	Exc. Suspensión Deportiva	○ 69952
94-95	Todos	↓ G55527	142326 ⁵³

E350

11-13	Todos	↓ G511041
-------	-------	-------	-------	-------	-------	-------	-----------	-------	-------	-------	-------

E400

13	Todos	↓ G511041
----	-------	-------	-------	-------	-------	-------	-----------	-------	-------	-------	-------

E420

97	Todos	○ 69966
	Exc. 4 Matic	○ 69952	143086 ⁵³	○ 69966
94-95	Todos	↓ G55527	142326 ⁵³

E430

98-02	Todos	○ 69966
	Exc. 4 Matic	143086 ⁵³	○ 69966
	Exc. Suspensión Deportiva	○ 69952	○ 69966

E500

11-13	Todos	↓ G511041
94	Todos	↓ G55527	142326 ⁵³

E550



11-13	Todos	↓ G511041
-------	-------	-------	-------	-------	-------	-------	-----------	-------	-------	-------	-------

ML55 AMG

00-03	Todos	○ G64049
-------	-------	----------	-------	-------	-------	-------	-------	-------	-------	-------	-------

53 Montaje de Strut. Es probable reutilizar algunas partes del E.O.

AMORTIGUADORES Y STRUTS

Año	Notas de Aplicación	Front					Rear				
			Ultra	ProGuard\ Guardian	LTV\ Max Control	Protector de Strut\ Bases de Strut	HiJacker\ Soporte\ Hidráulico		Ultra	ProGuard\ Guardian	LTV\ Max Control

MERCEDES-BENZ

ML320

98-03	Todos		G64049
-------	-------	---	--------	------	------	------	------	------	------	------	------	------

ML350

03-05	Todos		G64049
-------	-------	---	--------	------	------	------	------	------	------	------	------	------



ML430

99-01	Todos		G64049
-------	-------	---	--------	------	------	------	------	------	------	------	------	------

ML500

02-05	Todos		G64049
-------	-------	---	--------	------	------	------	------	------	------	------	------	------



S320 / S350 / S420 / S500 / S600

94-99	Exc. Control de Manejo Electrónico		70023		70024
-------	------------------------------------	---	-------	------	------	------	------	---	-------	------	------	------	------





SL320 / SL500 / SL600

94-02	Todos		142326 ⁵³
-------	-------	---	------	------	------	----------------------	------	------	------	------	------	------





SLK230

98-04	Todos		70064		70065
-------	-------	---	-------	------	------	------	------	---	-------	------	------	------	------



SLK320

03-04	Todos		70064		70065
01-02	170.465(Código plataforma del fabricante)		70064		70065





SPRINTER

04-06	Todos		G56778	
	Doble Rodada Trasera		G56778		G63919
	Exc. Doble Rodada Trasera		G56778		G63918





SPRINTER 315

07-12	Cargo Van & Chassis Cab Exc. LWB			G64091
07-10	Cargo Van & Chassis Cab		G52343	

SPRINTER 415 & 515

11-12	Todos			G64089
07-10	Todos		G52341		G64089



VW CRAFTER

08-11	Todos		G52343	
08-10	Chassis Exc. HD (MWB)		G52343		G64091
07	Chassis Exc. HD (MWB)			G64091

MERCURY

MERCURY

BOBCAT

75-80	Todos		82128
	Sedan		82128		82004

53 Montaje de Strut. Es probable reutilizar algunas partes del E.O.

AMORTIGUADORES Y STRUTS

Año	Notas de Aplicación	From					Rear				
		Ultra	ProGuard\ Guardian	LTV\ Max Control	Protector de Strut\ Bases de Strut	HiJacker\ Soporte\ Hidráulico	Ultra	ProGuard\ Guardian	LTV\ Max Control	Protector de Strut\ Bases de Strut	HiJacker\ Soporte\ Hidráulico

MERCURY

BROUGHAM

67	Todos	69675 ⁵	81446	34073 ⁸	69606	81495	43140 ⁶ 49205 ⁷
----	-------	--------------------	-------	------	------	--------------------	-------	-------	------	------	--

CAPRI

91-93	Todos	G55602	G55603
79-86	Todos	G56504 ⁹	142197 ⁵³	69633	81460	43143 ⁶ 49199 ⁷

CAPRI ESTABILIZADORES DE DIRECCIÓN

84-86	Todos					Delantero		Trasero			
						14039				

COLONY PARK

87-91	Todos	69675 ⁵	81446	34073 ⁸	69606	81495	43140 ⁶ 49205 ⁷
65-74	Todos	69675 ⁵	81446	34073 ⁸	69606	81495	43140 ⁶ 49205 ⁷
61-64	Todos	82099	82076
59-60	Todos	82099	81270	49105 ⁷
57-58	Todos	82099

COMET

71-77	Todos	81076	82130
68-69	Todos	82126	81270	49105 ⁷
66-67	Todos	82126
	Exc. Wagon	82126	81270	49105 ⁷
	Wagon	82126	69606	81495
60-65	Todos	82126	81270	49105 ⁷

COMMUTER

65-68	Todos	69675 ⁵	81446	34073 ⁸	69606	81495	43140 ⁶ 49205 ⁷
64	Todos	82099	82076
61-62	Todos	82099	82076
59-60	Todos	82099	81270	49105 ⁷
57-58	Todos	82099

COUGAR

01-02	Todos	G56520	142843 ⁵⁴	G55693
99-00	Todos	G56520	142843 ⁵⁴	G55693	142402 ⁵³
92-97	Exc. Suspensión Electrónica Ajustable	G55579	142222 ⁵³	69845	81795
89-91	Exc. Suspensión Electrónica Ajustable	G55579	142222 ⁵³	69820
87-88	Todos	G56504 ⁹	69709 ⁹	81461	49196 ⁷
83-86	Todos	G56503 ³⁹	69709 ⁹	81461	49196 ⁷
81-82	Modelos Base, GS y LS	G56504 ⁹	142197 ⁵³	69633	81460	43143 ⁶ 49199 ⁷

5 Use el kit 140719 para reemplazar partes del EO de montaje inferior cuando los pernos se rompan o los tornillos autoroscantes no se puedan utilizar más.

8 Paquetes en pares

39 El strut de aire ajustable de EO puede reemplazarse con un strut convencional.

Sin embargo, el sistema de autonivelación debe desactivarse. Vea Ref. A.





54 Kit con Montaje y Rodamiento. Es probable que reutilizar algunas partes del E.O.

7 Paquetes en pares; kit de mangueras de aire incluido

9 Vea Ref.D para los procedimientos de reemplazo de una Susp. Elect. Ajust. con un producto no ajust.

53 Montaje de Strut. Es probable reutilizar algunas partes del E.O.









AMORTIGUADORES Y STRUTS

Año	Notas de Aplicación										
			Ultra	ProGuard\ Guardian	LTV\ Max Control	Protector de Strut\ Bases de Strut	HiJacker\ Soporte\ Hidráulico		Ultra	ProGuard\ Guardian	LTV\ Max Control

MERCURY

MERCURY

COUGAR (cont)

80-82	XR-7		G56503 ³⁹		69709 ⁹	81461	49196 ⁷
74-79	Todos		69675 ⁵	81446	34073 ⁸		69606	81495	43140 ⁸ 49205 ⁷
71-73	Todos		81491		81270	49105 ⁷
67-70	Todos		81076		81270	49105 ⁷





COUGAR ESTABILIZADORES DE DIRECCIÓN

		Delantero	Trasero
84-88	Todos	14039



COUGAR READYMOUNTS

		Delantero	Trasero
99-01	Todos	G57052 ¹⁰
89-97	Izquierdo Exc. Suspensión Electrónica Ajustable	G56976 ⁴⁰
	Derecho Exc. Suspensión Electrónica Ajustable	G56977 ⁴⁰



















COUNTRY CRUISER

63	Todos		82099		82076
59-60	Todos		82099		81270	49105 ⁷

CUSTOM

52-56	Todos		82026	
-------	-------	---	------	-------	------	------	------	---	------	------	------	------	------





GRAND MARQUIS

07-11	Todos		G51887	143356 ⁵³ 143357 ⁵⁸		69575
06	Todos		143356 ⁵³ 143357 ⁵⁸		69575
	Fab. hasta 12/05		G51887	143356 ⁵³ 143357 ⁵⁸		69575
05	Todos		G51887	143356 ⁵³ 143357 ⁵⁸		69575
04	Todos		G51887	143356 ⁵³ 143357		69575
03	Todos		G51887	143356 ⁵³ 143357 ⁵⁸		69575
92-02	Todos		69675 ⁵	81446		69606	81495
	Exc. Sistema de Autonivelación NIVOMAT		69675 ⁵	81446	34073 ⁸		69606	81495	43140 ⁸ 49205 ⁷
75-91	Todos		69675 ⁵	81446	34073 ⁸		69606	81495	43140 ⁸ 49205 ⁷



GRAND MARQUIS READYMOUNTS

		Delantero	Trasero
03-11	Todos	G57080 ⁴⁰

LN7

82-83	Todos			G55705
83	Fab. desde 2/83		G55712		G55705

LYNX

85-87	Fab. desde 3/85		G55714		G55705
-------	-----------------	---	--------	------	------	------	------	---	--------	------	------	------	------

5 Use el kit 140719 para reemplazar partes del EO de montaje inferior cuando los pernos se rompan o los tornillos autoroscantes no se puedan utilizar más.

8 Paquetes en pares

39 El strut de aire ajustable de EO puede reemplazarse con un strut convencional. Sin embargo, el sistema de autonivelación debe desactivarse. Vea Ref. A.

53 Montaje de Strut. Es probable reutilizar algunas partes del E.O.

7 Paquetes en pares; kit de mangueras de aire incluido



9 Vea Ref.D para los procedimientos de reemplazo de una Susp. Elect. Ajust. con un producto no ajust.

40 Strut ReadyMount. Ensamble Completo

68 Kit de Accesorios de Montaje. Aislador de Goma del Asiento de Resorte. Es probable reutilizar algunas partes del E.O.





Texto en Negritas - Número de Parte Nuevo / Futuro

AMORTIGUADORES Y STRUTS

Año	Notas de Aplicación	From					Rear				
			Ultra	ProGuard\ Guardian	LTV\ Max Control	Protector de Strut\ Bases de Strut	HiJacker\ Soporte\ Hidráulico		Ultra	ProGuard\ Guardian	LTV\ Max Control









MERCURY

LYNX (cont)











81-87	Todos			G55705
83-85	Fab. desde 2/83 hasta 3/85		G55712		G55705

MERCURY

MARAUDER

03-04	Todos		G51888		69575	
69-70	Todos		69675 ⁵	81446	34073 ⁸		69606	81495	43140 ⁶ 49205 ⁷
65-67	Todos		69675 ⁵	81446	34073 ⁸		69606	81495	43140 ⁶ 49205 ⁷
63-64	Todos		82099		82076





MARINER

08-11	Izquierdo		G56601		G64047
	Derecho		G56568		G64047
05-11	FWD		143253 ⁵³	
05-07	Izquierdo		G56601		69900 G63862
	Derecho		G56568		69900 G63862





MARINER READYMOUNTS

		Delantero		Trasero	
05-11	Izquierdo	G57045⁴⁰		
	Derecho	G57046⁴⁰		



MARQUIS

83-86	Todos		G56504 ⁹	142197 ⁵³		69633	81460	43143 ⁶ 49199 ⁷
67-82	Todos		69675 ⁵	81446	34073 ⁸		69606	81495	43140 ⁶ 49205 ⁷



MEDALIST

58	Todos		82099	
56	Todos		82026	











MERCURY

49-51	Todos		82026		81318
-------	-------	---	------	-------	------	------	------	---	------	-------	------	------	------

METEOR

62-63	Todos		82075		81270	49105 ⁷
-------	-------	---	------	-------	------	------	------	---	------	-------	------	------	--------------------

MILAN

10-11	Izquierdo		G51896	143392⁵³	
	Derecho		G51897	143392⁵³	
	FWD			69591
06-09	Todos		G51859	143392⁵³	
	FWD		G51859	143392⁵³		69591

5 Use el kit 140719 para reemplazar partes del EO de montaje inferior cuando los pernos se rompan o los tornillos autoroscantes no se puedan utilizar más.

8 Paquetes en pares

40 Strut ReadyMount. Ensamble Completo





Texto en Negritas - Número de Parte Nuevo / Futuro

7 Paquetes en pares; kit de mangueras de aire incluido

9 Vea Ref.D para los procedimientos de reemplazo de una Susp. Elect. Ajust. con un producto no ajust.

53 Montaje de Strut. Es probable reutilizar algunas partes del E.O.



AMORTIGUADORES Y STRUTS

Año	Notas de Aplicación										
			Ultra	ProGuard\ Guardian	LTV\ Max Control	Protector de Strut\ Bases de Strut	HiJacker\ Soporte\ Hidráulico		Ultra	ProGuard\ Guardian	LTV\ Max Control











MERCURY

MERCURY



















MONARCH

75-80	Todos		81491		82130
-------	-------	---	-------	-------	-------	-------	-------	---	-------	-------	-------	-------	-------















MONTCLAIR

65-68	Todos		69675 ⁵	81446	34073 ⁸		69606	81495	43140 ⁸ 49205 ⁷
64	Todos		82099		82076
59-60	Todos		82099		81270	49105 ⁷
57-58	Todos		82099	
55-56	Todos		82026	









MONTEGO

05-07	Izquierdo		143341 ⁵³		143390 ⁵³
	Derecho		143341 ⁵³		143391
	FWD, Izquierdo		G52138		G51849
	FWD, Derecho		G52139		G51849
72-76	Todos		69675 ⁵	81446	34073 ⁸		69606	43140 ⁸ 49205 ⁷
	Wagon		69675 ⁵	81446	34073 ⁸		69606	81495	43140 ⁸ 49205 ⁷
68-71	Todos		82126		69606
	Exc. Wagon		82126		69606	81270	49105 ⁷
	Wagon		82126		69606	81495

MONTEREY

04-07	Mini Passenger Van		G56655	143246 ⁵³		G63873
65-74	Todos		69675 ⁵	81446	34073 ⁸		69606	81495	43140 ⁸ 49205 ⁷
61-64	Todos		82099		82076
59-60	Todos		82099		81270	49105 ⁷
57-58	Todos		82099	
52-56	Todos		82026	
50-51	Todos		82026		81318

MOUNTAINEER

06-10	Todos		G56838	143330 ⁵³ 143360 ⁵³		G56839	143361 ⁵³ 143362 ⁵⁰
04-05	Todos		G51723	143318 ⁵³		G51724	143319 ⁵³
02-03	Todos		G51722	143318 ⁵³		G51724	143319 ⁵³
97-01	Exc. Suspensión Electrónica Ajustable		G63678	61623 81893	77678		G63679	61624 81890	77679	43171 ⁸ 49232 ⁷

MOUNTAINEER READYMOUNTS

		Delantero	Trasero
06-10	Todos	G57095⁴⁰	G57096⁴⁰
04-05	Todos	G57019⁴⁰	G57018⁴⁰
02-03	Todos	G57017⁴⁰	G57018⁴⁰

5 Use el kit 140719 para reemplazar partes del EO de montaje inferior cuando los pernos se rompan o los tornillos autoroscantes no se puedan utilizar más.

8 Paquetes en pares

53 Montaje de Strut. Es probable reutilizar algunas partes del E.O.

Texto en Negritas - Número de Parte Nuevo / Futuro

7 Paquetes en pares; kit de mangueras de aire incluido

40 Strut ReadyMount. Ensamble Completo

70 Kit Buje y Camisa. Algunos accesorios del Equipo Original podrían ser necesarios

AMORTIGUADORES Y STRUTS

Año	Notas de Aplicación	From					Rear				
		Ultra	ProGuard\ Guardian	LTV\ Max Control	Protector de Strut\ Bases de Strut	HiJacker\ Soporte\ Hidráulico	Ultra	ProGuard\ Guardian	LTV\ Max Control	Protector de Strut\ Bases de Strut	HiJacker\ Soporte\ Hidráulico

MERCURY

MYSTIQUE

MERCURY

97-00	Fab. desde 3/97	↓	G56520	142843 ⁵⁴	↓	G55693	142402 ⁵³
95-00	Todos	↓	142843 ⁵⁴	↓	G55693	142402 ⁵³
95-97	Fab. hasta 3/97	↓	G55692	142843 ⁵⁴	↓	G55693	142402 ⁵³

MYSTIQUE READYMOUNTS

		Delantero	Trasero
95-00	Todos	G57052 ⁴⁰

PARKLANE

65-68	Todos	⊕	69675 ⁵	81446	34073 ⁸	⊕	69606	81495	43140 ⁹ 49205 ⁷
64	Todos	⊕	82099	⊕	82076
59-60	Todos	⊕	82099	⊕	81270	49105 ⁷
58	Todos	⊕	82099	⊕

SABLE

08-09	FWD, Izquierdo	↓	G52129	143415 ⁵³	↓	G51875
	FWD, Derecho	↓	G52130	143415 ⁵³	↓	G51876
96-05	Izquierdo	↓	G55978	↓
	Derecho	↓	G55960	↓
	Sedan	↓	↓	G55901
	Wagon	↓	↓	69962	81927
94-95	Sedan	↓	G55616	142746 ⁶	↓	G55901
91-95	Todos	↓	G55616	↓
	Wagon	↓	G55616	⊕	69756	81693	49216 ⁷
91-93	Sedan	↓	G55616	142746 ⁶	↓	G55518
86-90	Todos	↓	G55616	142746 ⁶	↓
	Sedan	↓	G55616	142746 ⁶	↓	G55518
	Wagon	↓	G55616	142746 ⁶	⊕	69756	81693	49216 ⁷

SABLE READYMOUNTS

		Delantero	Trasero
96-05	Izquierdo	G56934 ⁴⁰
	Derecho	G56937 ⁴⁰
	Sedan	G56936 ⁴⁰
94-95	Sedan	G56912 ⁴⁰	G56936 ⁴⁰
86-95	Todos	G56912 ⁴⁰
86-93	Sedan	G56912 ⁴⁰	G56913 ⁴⁰

5 Use el kit 140719 para reemplazar partes del EO de montaje inferior cuando los pernos se rompan o los tornillos autoroscantes no se puedan utilizar más.

7 Paquetes en pares; kit de mangueras de aire incluido

40 Strut ReadyMount. Ensamble Completo

54 Kit con Montaje y Rodamiento. Es probable que reutilizar algunas partes del E.O.

Texto en Negritas - Número de Parte Nuevo / Futuro

6 Se recomienda que cuando se reemplacen amortiguadores "quad", los 4 sean de la misma serie.

8 Paquetes en pares

53 Montaje de Strut. Es probable reutilizar algunas partes del E.O.

AMORTIGUADORES Y STRUTS

Año	Notas de Aplicación	Front					Rear				
		Ultra	ProGuard\ Guardian	LTV\ Max Control	Protector de Strut\ Bases de Strut	HiJacker\ Soporte\ Hidráulico	Ultra	ProGuard\ Guardian	LTV\ Max Control	Protector de Strut\ Bases de Strut	HiJacker\ Soporte\ Hidráulico

MERCURY

TOPAZ

92-94	FWD, Fab. desde 3/85	G55714
84-94	FWD	G55733
87-91	Fab. desde 3/85	G55714
	AWD	G55722
85-86	FWD, Fab. desde 3/85	G55714

MERCURY

TRACER

97-99	FWD	G56515	142744 ⁶⁵ 142832 ⁶⁴	G55848	142190 ⁵³
91-96	FWD	G55847	142744 ⁶⁵	G55848	142190 ⁵³
87-89	FWD	G55710	142183 ⁶³	G55544

TRACER READYMOUNTS

		Delantero		Trasero	
97-99	FWD	G56926 ⁴⁰		G56940 ⁴⁰	
91-96	FWD	G56911 ⁴⁰		G56940 ⁴⁰	

TURNPIKE CRUISER

57	Todos	⊕	82099
----	-------	---	------	-------	------	------	------	------	------	------

VILLAGER

97-02	Non-ABS	G63299	61637	
02	Izquierdo	G56785	
	Derecho	G56784	
99-01	Izquierdo	G56785	142860 ⁶⁴	
	Derecho	G56784	142860 ⁶⁴	
93-98	Izquierdo	G55920	142860 ⁶⁴	
	Derecho	G55921	142860 ⁶⁴	
93-96	4-Wheel ABS	G63299	61637	
65-67	Todos	⊕	69675 ⁵	81446	34073 ⁸	69606	81495	43140 ⁹ 49205 ⁷
62-64	Todos	⊕	82099	82076	

VILLAGER READYMOUNTS

		Delantero		Trasero	
93-98	Izquierdo	G56989 ⁴⁰		
	Derecho	G56990 ⁴⁰		

VOYAGER

66-67	Todos	⊕	69675 ⁵	81446	34073 ⁸	69606	81495	43140 ⁹ 49205 ⁷
59	Todos	⊕	82099	81270

5 Use el kit 140719 para reemplazar partes del EO de montaje inferior cuando los pernos se rompan o los tornillos autoroscantes no se puedan utilizar más.

8 Paquetes en pares

53 Montaje de Strut. Es probable reutilizar algunas partes del E.O.

65 El Kit de Montaje incluye: Asiento de Resorte Superior con Aislador. Es probable reutilizar algunas partes del E.O.

Texto en Negritas - Número de Parte Nuevo / Futuro

7 Paquetes en pares; kit de mangueras de aire incluido

40 Strut ReadyMount. Ensemble Completo

54 Kit con Montaje y Rodamiento. Es probable que reutilizar algunas partes del E.O.

AMORTIGUADORES Y STRUTS

Año	Notas de Aplicación	From					Rear				
		Ultra	ProGuard\ Guardian	LTV\ Max Control	Protector de Strut\ Bases de Strut	HiJacker\ Soporte\ Hidráulico	Ultra	ProGuard\ Guardian	LTV\ Max Control	Protector de Strut\ Bases de Strut	HiJacker\ Soporte\ Hidráulico

MERCURY

VOYAGER (cont)

MERCURY

57-58	Todos	82099
-------	-------	-------	-------	-------	-------	-------	-------	-------	-------	-------

ZEPHYR

78-83	Todos	G56504 ⁹	142197 ⁵³	69633	81460	43143 ⁸ 49199 ⁷
-------	-------	---------------------	-------	-------	----------------------	-------	-------	-------	-------	-------	--

MINI

COOPER

MINI

12	Izquierdo	G52297	143491	G51934
	Derecho	G52298	143491	G51934
07-11	Izquierdo	G52297	143491	G51934	143405
	Derecho	G52298	143491	G51934	143405
02-06	Izquierdo	G52164	143404 ⁵³	G51881	143405
	Derecho	G52165	143404 ⁵³	G51881	143405

MITSUBISHI

3000GT

MITSUBISHI

91-99	Todos	142419 ⁵³
-------	-------	-------	-------	-------	-------	-------	-------	-------	-------	----------------------	-------

CORDIA

83-88	Todos	69689	81464
-------	-------	-------	-------	-------	-------	-------	-------	-------	-------	-------	-------

DIAMANTE

04	Todos	143087 ⁵³	142419 ⁵³
97-03	Izquierdo	G52227	143087 ⁵³	G51772	142419 ⁵³
	Derecho	G52228	143087 ⁵³	G51772	142419 ⁵³

ECLIPSE

11-12	Izquierdo	G52166
	Derecho	G52167
06-10	Izquierdo	G52166	G51882
	Derecho	G52167	G51882
00-05	Izquierdo	G56552	143087 ⁵³	G51712	142419 ⁵³
	Derecho	G56551	143087 ⁵³	G51712	142419 ⁵³
95-99	Todos	G55819	142419 ⁵³	142419 ⁵³
	AWD	G55819	142419 ⁵³	G51712	142419 ⁵³
	FWD	G55819	142419 ⁵³	G51254	142419 ⁵³

7 Paquetes en pares; kit de mangueras de aire incluido



8 Paquetes en pares

9 Vea Ref.D para los procedimientos de reemplazo de una Susp. Elect. Ajust. con un producto no ajust.

53 Montaje de Strut. Es probable reutilizar algunas partes del E.O.

Texto en Negritas - Número de Parte Nuevo / Futuro

AMORTIGUADORES Y STRUTS

Año	Notas de Aplicación										
		Ultra	ProGuard\ Guardian	LTV\ Max Control	Protector de Strut\ Bases de Strut	HiJacker\ Soporte\ Hidráulico	Ultra	ProGuard\ Guardian	LTV\ Max Control	Protector de Strut\ Bases de Strut	HiJacker\ Soporte\ Hidráulico

MITSUBISHI

ECLIPSE (cont)

91-94	Todos	G55605	142219 ⁵³	142419 ⁵³
	AWD	G55605	142219 ⁵³	G51046	142419 ⁵³
	FWD	G55605	142219 ⁵³	G51184	142419 ⁵³
90	Todos	G55587	142219 ⁵³	142419 ⁵³
	AWD	G55587	142219 ⁵³	G51046	142419 ⁵³
	FWD	G55587	142219 ⁵³	G51184	142419 ⁵³

MITSUBISHI

ENDEAVOR

04-11	Izquierdo	G52293	143398	G51933
	Derecho	G52294	143398	G51933

EXPO

92-95	Todos	G55945	69462	142419 ⁵³
-------	-------	--------	------	------	------	------	-------	------	----------------------	------

GALANT

08-11	Exc. Modelos GT, LS, Sport, Ralliart Izquierdo	G52168	G51883
	Exc. Modelos GT, LS, Sport, Ralliart Derecho	G52169	G51883
04-07	Todos	142419 ⁵³
	Exc. Modelos GT, LS, Sport, Ralliart Izquierdo	G52168	G51883	142419 ⁵³
	Exc. Modelos GT, LS, Sport, Ralliart Derecho	G52169	G51883	142419 ⁵³
04-06	LS, Izquierdo	G52362	G51969	142419 ⁵³
	LS, Derecho	G52363	G51969	142419 ⁵³
99-03	Izquierdo	G56636	143087 ⁵³	G51254	142419 ⁵³
	Derecho	G56635	143087 ⁵³	G51254	142419 ⁵³
94-98	Todos	G55820	142419 ⁵³	G51253	142419 ⁵³
89-93	Todos	142419 ⁵³
	FWD	G55609	G51424	142419 ⁵³
90-92	AWD	G55605	G51046	142419 ⁵³
85-88	Exc. Suspensión Electrónica Ajustable	G51424	142419 ⁵³

GALANT READYMOUNTS



							Delantero	Trasero
99-03	GTZ						G57075 ¹⁰

40 Strut ReadyMount. Ensamble Completo

53 Montaje de Strut. Es probable reutilizar algunas partes del E.O.



Texto en Negritas - Número de Parte Nuevo / Futuro

AMORTIGUADORES Y STRUTS

Año	Notas de Aplicación	From 					Rear 				
		Ultra	ProGuard\ Guardian	LTV\ Max Control	Protector de Strut\ Bases de Strut	HiJacker\ Soporte\ Hidráulico	Ultra	ProGuard\ Guardian	LTV\ Max Control	Protector de Strut\ Bases de Strut	HiJacker\ Soporte\ Hidráulico











MITSUBISHI

L200









08-15	Todos	 G511140	 G511141
-------	-------	---	------	------	------	------	---	------	------	------	------

MITSUBISHI

LANCER

08-10	Todos		143394 ³	
	DE, ES	 G51908	143394 ³	
	GTS	 G51977	143394 ³	
	Modelos DE y ES Izquierdo	 G52262		143394 ³
	Modelos DE y ES Derecho	 G52263		143394 ³
02-07	Todos		143284	
	Todos	143088 ⁵³		143394 ³ 143284	
	Exc. ES y Evolution Series	 G56894	 G51794	143284	















MIGHTY MAX

95-96	Todos		70163
	Todos	 G63907	61500 81147	77907	43048 ⁸ 49310 ⁷ 70163
	RWD	 G63950	61556 81714	77418		70163
83-94	4WD	 G63418	61529	77418	 G63419	61532 81538
	RWD	 G63950	61556 81714	 G63907	61500 81147	77907	43048 ⁸ 49310 ⁷
	RWD		70163

MIGHTY MAX ESTABILIZADORES DE DIRECCIÓN

		Delantero	Trasero
95-96	Estabilizador de Dirección Sistema Sencillo	6802SE ⁸⁴
83-94	RWD, Estabilizador de Dirección Sistema Sencillo	6802SE ⁸⁴

MIRAGE

97-02	Todos	 G51063	142419 ⁵³
	Fab. desde 4/97; con Resorte de 6" o 7" Izquierdo	 G56530	 G51063	142419 ⁵³
	Fab. desde 4/97; con Resorte de 6" o 7" Derecho	 G56529	 G51063	142419 ⁵³
96	Fab. hasta 5/96	 G55911	142329 ⁵³	 G51063	142419 ⁵³
95	Todos	 G55911	 G51063
	Sedan	 G55911	142329 ⁵³	 G51063	142419 ⁵³
93-94	Todos	 G55911	142329 ⁵³	 G51063	142419 ⁵³
89-92	Todos	 G55592	 G51249	142419 ⁵³

3 Número de parte futuro

8 Paquetes en pares

84 Amortiguador de repuesto para los vehículos con el kit de montaje aftermarket

GRC

Texto en Negritas - Número de Parte Nuevo / Futuro

7 Paquetes en pares; kit de mangueras de aire incluido

53 Montaje de Strut. Es probable reutilizar algunas partes del E.O.

AMORTIGUADORES Y STRUTS

Año	Notas de Aplicación	Front					Rear				
		Ultra	ProGuard\ Guardian	LTV\ Max Control	Protector de Strut\ Bases de Strut	HiJacker\ Soporte\ Hidráulico	Ultra	ProGuard\ Guardian	LTV\ Max Control	Protector de Strut\ Bases de Strut	HiJacker\ Soporte\ Hidráulico

MITSUBISHI

MIRAGE (cont)

87-88	Todos	G55561
-------	-------	--------	------	------	------	------	------	------	------	------

MITSUBISHI

MONTERO

08-11	Todos	G511066
05-11	Limited	G511065 G511066
08-10	Sport	G511063	G511066
05-06	Todos	G511066
04	Exc. Sport	G51839	G64036
01-03	Todos	143464 ⁵³
	Exc. Sport	G51839	143464 ⁵³	G64036
92-00	Todos	G63782 ⁹	77782 ⁹	G63781 ⁹	77781 ⁹
90-91	Todos	G63418	61529	77418	61568
	3.0L 6 Cyl V	G63418	61529	77418	G63604	61568
89	Todos	G63418	61529	77418	61568 81318	77492	49311 ⁷
	2.6L 4Cyl L	G63418	61529	77418	G63492	61568 81318	77492	49311 ⁷
	3.0L 6 Cyl V	G63418	61529	77418	G63604	61568 81318	77492	49311 ⁷
83-88	Todos	G63418	61529	77418	81318	77492	49311 ⁷
	2.6L 4Cyl L	G63418	61529	77418	G63492	61506 81318	77492	49311 ⁷

MONTERO ESTABILIZADORES DE DIRECCIÓN

		Delantero		Trasero	
86-95	Estabilizador de Dirección Sistema Sencillo	6802SE ⁸⁴		

MONTERO SPORT

08-12	Todos	G511063	G511064
00-07	Todos	G64027	G64028
97-99	Todos	G63782 ⁹	77782 ⁹	G63492	61506	77492	49311 ⁷

OUTLANDER

12-13	Modelos SE, XLS y GT w/ 3rd Row Seating Izquierdo	G52299
	Modelos SE, XLS y GT w/ 3rd Row Seating Derecho	G52300
09-11	Modelos SE, XLS y GT w/ 3rd Row Seating Izquierdo	G52299	G511004	143394 ³
	Modelos SE, XLS y GT w/ 3rd Row Seating Derecho	G52300	G511004	143394 ³
08-11	Todos	143394 ³
08	XLS, Izquierdo	G52299	G511004	143394 ³
	XLS, Derecho	G52300	G511004	143394 ³

3 Número de parte futuro

9 Vea Ref.D para los procedimientos de reemplazo de una Susp. Elect. Ajust. con un producto no ajust.

84 Amortiguador de repuesto para los vehículos con el kit de montaje aftermarket GRC

Texto en Negritas - Número de Parte Nuevo / Futuro

7 Paquetes en pares; kit de mangueras de aire incluido

53 Montaje de Strut. Es probable reutilizar algunas partes del E.O.

AMORTIGUADORES Y STRUTS

Año	Notas de Aplicación	From					Rear				
		Ultra	ProGuard\ Guardian	LTV\ Max Control	Protector de Strut\ Bases de Strut	HiJacker\ Soporte\ Hidráulico	Ultra	ProGuard\ Guardian	LTV\ Max Control	Protector de Strut\ Bases de Strut	HiJacker\ Soporte\ Hidráulico

MITSUBISHI

OUTLANDER (cont)

07	Izquierdo	G52299	G511004	143394 ³
	Derecho	G52300	G511004	143394 ³
05-06	Todos	G52065	143088 ⁵³	143394 ³
03-04	Todos	G52065	143088 ⁵³	G51838	143394 ³

MITSUBISHI

PRECIS

90-94	Todos	G55586	69689	81464
87-89	Struts Delanteros Reconstruibles de EO	G44944 ⁹⁸	69689

RAIDER

06-09	Todos	G51815	143385 ⁵³
	4WD	G51815	143385 ⁵³	G63891
	RWD	G51815	143385 ⁵³	G63890

SIGMA

89-90	Non-ABS Exc. Sistema de Autonivelación	G51424	142419 ⁵³
-------	--	------	------	------	------	------	--------	------	------	----------------------	------

STARION

87-89	Exc. Suspensión Electrónica Ajustable	G44937 ⁹⁸
-------	---------------------------------------	----------------------	------	------	------	------	------	------	------	------	------

TREDIA

83-88	Todos	69689	81464
-------	-------	------	------	------	------	------	-------	-------	------	------	------

VAN

87-90	Todos	70163
	Todos	G63904	61593 81872	77904	G63907	61500 81147	77907	43048 ⁸ 49310 ⁷ 70163

NISSAN

120I

07	Todos	G52211	70011
----	-------	--------	------	------	------	------	-------	------	------	------	------

200SX

95-98	Todos	142623 ⁵⁴
	Izquierdo Eje Trasero Rígido B14	G55970	142623 ⁵⁴	G51230
	Derecho Eje Trasero Rígido B14	G55971	142623 ⁵⁴	G51230
85-88	Todos	G44934 ⁹⁸	81671
84	Eje Delantero Rígido	G44934 ⁹⁸	81501

NISSAN

3 Número de parte futuro

8 Paquetes en pares

54 Kit con Montaje y Rodamiento. Es probable que reutilizar algunas partes del E.O.



7 Paquetes en pares; kit de mangueras de aire incluido

53 Montaje de Strut. Es probable reutilizar algunas partes del E.O.

98 Nota: El nivel de dificultad para instalar este producto es moderadamente alto. Por favor revise las instrucciones cuidadosamente antes de comenzar.

Texto en Negritas - Número de Parte Nuevo / Futuro





AMORTIGUADORES Y STRUTS

Año	Notas de Aplicación	Front					Rear				
			Ultra	ProGuard\ Guardian	LTV\ Max Control	Protector de Strut\ Bases de Strut	HiJacker\ Soporte\ Hidráulico		Ultra	ProGuard\ Guardian	LTV\ Max Control



NISSAN

NISSAN





200SX (cont)

80-83	Todos		G44752 ⁹⁸		81501
77-79	Todos			81501



210

79-82	Todos		G44752 ⁹⁸		81501
-------	-------	---	----------------------	------	------	------	------	---	------	-------	------	------	------









240SX

89-94	Izquierdo Exc. Suspensión Activa		G55903	142430 ⁵³		G51191
	Derecho Exc. Suspensión Activa		G55904	142430 ⁵³		G51191



240Z

70-73	Todos		G44869 ⁹⁸	142241 ⁵⁸		G44868 ⁹⁸
-------	-------	---	----------------------	------	------	----------------------	------	---	----------------------	------	------	------	------





260Z

74-75	Todos		G44869 ⁹⁸	
	2+2		G44869 ⁹⁸		G44867 ⁹⁸
74	Fab. 9/74		G44869 ⁹⁸	142241 ⁵⁸	
	Base		G44869 ⁹⁸		G44868 ⁹⁸









280Z

75-78	Todos		G44869 ⁹⁸	142241 ⁵⁸		G44867 ⁹⁸
-------	-------	---	----------------------	------	------	----------------------	------	---	----------------------	------	------	------	------











280ZX

83	Todos		G44869 ⁹⁸	142241 ⁵⁸		G51232
79-82	Todos		G44869 ⁹⁸	142241 ⁵⁸		G51229

300ZX

90-96	2+2, Izquierdo Exc. model spec VG30DETT		G51188		G51190
	2+2, Derecho Exc. model spec VG30DETT		G51189		G51190
87-89	Todos		G44968 ⁹⁸	142241 ⁵⁸		69757
84-86	Todos		G44936 ⁹⁸	142241 ⁵⁸		69757

350Z

09	Izquierdo		G51953		G51955
	Derecho		G51954		G51955
06-08	Izquierdo		G51953	143455 ⁵³		G51955
	Derecho		G51954	143455 ⁵³		G51955
03-06	Coupe Exc. Suspensión Deportiva			G51764

53 Montaje de Strut. Es probable reutilizar algunas partes del E.O.

58 El Kit de Montaje incluye: Rodamiento de Suspensión. Es probable reutilizar algunas partes del E.O.

98 Nota: El nivel de dificultad para instalar este producto es moderadamente alto. Por favor revise las instrucciones cuidadosamente antes de comenzar.

Texto en Negritas - Número de Parte Nuevo / Futuro

AMORTIGUADORES Y STRUTS

Año	Notas de Aplicación	Front					Rear				
		Ultra	ProGuard\ Guardian	LTV\ Max Control	Protector de Strut\ Bases de Strut	HiJacker\ Soporte\ Hidráulico	Ultra	ProGuard\ Guardian	LTV\ Max Control	Protector de Strut\ Bases de Strut	HiJacker\ Soporte\ Hidráulico

NISSAN

NISSAN

350Z (cont)

03-05	Izquierdo	↓	G51813	143455 ⁵³
	Derecho	↓	G51814	143455 ⁵³
	Suspensión Deportiva	↓

410

64-65	Todos	↓	69600	81494	↓	82155
-------	-------	---	-------	-------	------	------	------	---	------	-------	------	------	------

411

64-67	Todos	↓	69600	81494	↓	82155
-------	-------	---	-------	-------	------	------	------	---	------	-------	------	------	------

510

78-81	Todos	↓	G44752 ⁹⁸	↓
	Hatchback	↓	G44752 ⁹⁸	↓	81501
	Sedan	↓	G44752 ⁹⁸	↓	81501
	Wagon	↓	G44752 ⁹⁸	↓	82156	49310 ⁷
72	Todos	↓	↓	81340

521 PICKUP

69-72	Todos	↓	70161	↓	70162
	Todos	↓	G63902	61501 81478	77902	70161	↓	G63491	61505 81097	49309 ⁷ 70162

610

75-76	Todos	↓	142241 ⁵⁸	↓
	Wagon	↓	142241 ⁵⁸	↓	69604	81492	49152 ⁷
73-74	Todos	↓	142241 ⁵⁸	↓	69604	49152 ⁷
	Wagon	↓	142241 ⁵⁸	↓	69604	81492	49152 ⁷

620 PICKUP

72-79	Todos	↓	70161	↓	70162
	Todos	↓	G63902	61501 81478	77902	70161	↓	G63491	61505 81097	49309 ⁷ 70162

710

74-77	Exc. Wagon	↓	↓	81340
	Wagon	↓	↓	69604	81492	43060 ⁸ 49152 ⁷

720 PICKUP

85-86	Todos	↓	G63902	61501 81478	77902	70161	↓	70162
	4WD	↓	G63902	61501 81478	77902	70161	↓	G63492	61506 81318	77492	49311 ⁷ 70162
86	RWD	↓	G63902	61501 81478	77902	70161	↓	49309 ⁷ 70162

7 Paquetes en pares; kit de mangueras de aire incluido

53 Montaje de Strut. Es probable reutilizar algunas partes del E.O.



98 Nota: El nivel de dificultad para instalar este producto es moderadamente alto. Por favor revise las instrucciones cuidadosamente antes de comenzar.

8 Paquetes en pares

58 El Kit de Montaje incluye: Rodamiento de Suspensión. Es probable reutilizar algunas partes del E.O.

Texto en Negritas - Número de Parte Nuevo / Futuro











AMORTIGUADORES Y STRUTS

Año	Notas de Aplicación	Front					Rear				
			Ultra	ProGuard\ Guardian	LTV\ Max Control	Protector de Strut\ Bases de Strut	HiJacker\ Soporte\ Hidráulico		Ultra	ProGuard\ Guardian	LTV\ Max Control

NISSAN

NISSAN















720 PICKUP (cont)

86	RWD, Fabricado antes de 8/86		G63902	61501 81478	77902	70161		G63491	61505 81097	70162
82-85	RWD		G63902	61501 81478	77902	70161		G63491	61505 81097	49309 ⁷ 70162
82-84	Todos		G63902	61501 81478	77902	70161	
	4WD		G63902	61501 81478	77902	70161		G63492	61506 81318	77492	49311 ⁷
80-81	Todos		G63902	61501 81478	77902	70161		G63491	61505 81097	49309 ⁷ 70162



720 PICKUP ESTABILIZADORES DE DIRECCIÓN

		Delantero	Trasero
82	Estabilizador de Dirección Sistema Sencillo	6802SE ⁸⁴



810

81	Todos		G44869 ⁹⁸	142241 ⁵⁸	
	Sedan		G44869 ⁹⁸	142241 ⁵⁸		G51229
79-80	Hardtop		142241 ⁵⁸		G51229
78-80	Wagon		142241 ⁵⁸		69604	81492	43060 ⁸ 49152 ⁷
77-80	Todos		142241 ⁵⁸	
	Sedan		142241 ⁵⁸		G51229
77	Wagon		142241 ⁵⁸		81492



1200

71-73	Todos			81501 82020
-------	-------	---	------	------	------	------	------	---	------	----------------	------	------	------







1600

66-70	Todos		69704		82130
-------	-------	---	-------	------	------	------	------	---	------	-------	------	------	------











2000

68-70	Todos		69704		82130
-------	-------	---	-------	------	------	------	------	---	------	-------	------	------	------

ALMERA

02-06	Izquierdo		G56740		G51730
	Derecho		G56741		G51730
01	Todos			G51730

ALTIMA

13-15	Todos			G51874
13	Exc. Modelo Hybrid Izquierdo		G52121		G51874
	Exc. Modelo Hybrid Derecho		G52122		G51874
09-12	Todos		143395		70089 G51874
	Exc. Modelo Hybrid Izquierdo		G52121	143395		70089 G51874

7 Paquetes en pares; kit de mangueras de aire incluido

58 El Kit de Montaje incluye: Rodamiento de Suspensión. Es probable reutilizar algunas partes del E.O.

98 Nota: El nivel de dificultad para instalar este producto es moderadamente alto. Por favor revise las instrucciones cuidadosamente antes de comenzar.

8 Paquetes en pares

84 Amortiguador de repuesto para los vehículos con el kit de montaje aftermarket GRC

AMORTIGUADORES Y STRUTS

Año	Notas de Aplicación	Front					Rear				
		Ultra	ProGuard\ Guardian	LTV\ Max Control	Protector de Strut\ Bases de Strut	HiJacker\ Soporte\ Hidráulico	Ultra	ProGuard\ Guardian	LTV\ Max Control	Protector de Strut\ Bases de Strut	HiJacker\ Soporte\ Hidráulico

NISSAN

NISSAN

ALTIMA (cont)

09-12	Exc. Modelo Hybrid Derecho	G52122	143395	70089 G51874
08	Todos	143395	G51874
	Exc. Modelo Hybrid Izquierdo	G52121	143395	G51874
	Exc. Modelo Hybrid Derecho	G52122	143395	G51874
07	Todos	143395	G51874	143214 ⁵³
	Exc. Modelo Hybrid Izquierdo	G52121	143395	G51874	143214 ⁵³
	Exc. Modelo Hybrid Derecho	G52122	143395	G51874	143214 ⁵³
02-06	Todos	142937 ⁵³	G51725	143214 ⁵³
	Kit w/ Mount and Bearing	142937 142937 ⁵³	G51725	143214 ⁵³
	Izquierdo	G56671	142937 ⁵³	G51725	143214 ⁵³
	Derecho	G56672	142937 ⁵³	G51725	143214 ⁵³
98-01	Izquierdo	G55832	G55669
	Derecho	G55833	G55668
93-97	Izquierdo	G55667	G55669
	Derecho	G55666	G55668

ALTIMA READYMOUNTS

		Delantero	Trasero
07-12	Exc. Modelo Hybrid Izquierdo	G57161
	Exc. Modelo Hybrid Derecho	G57162
02-06	Izquierdo	G57030 ⁴⁰
	Derecho	G57031 ⁴⁰
00-01	Izquierdo	G57003 ⁴⁰
	Derecho	G57004 ⁴⁰
93-99	Izquierdo	G57001 ⁴⁰	G57003 ⁴⁰
	Derecho	G57002 ⁴⁰	G57004 ⁴⁰

APRIO

08-10	Todos	G52211	70011
07	Todos	G52211

ARMADA

12-15	Exc. Sistema de Autonivelación	G51715	G63875
07-11	Todos	143358 ⁵³ 143359 ⁷⁰
	Exc. Sistema de Autonivelación	G51715	143358 ⁵³ 143359 ⁷⁰	G63875
05-06	Todos	143358 ⁵³

40 Strut ReadyMount. Ensamble Completo

70 Kit Bujes y Camisa. Algunos accesorios del Equipo Original podrían ser necesarios

Texto en Negritas - Número de Parte Nuevo / Futuro

53 Montaje de Strut. Es probable reutilizar algunas partes del E.O.

AMORTIGUADORES Y STRUTS

Año	Notas de Aplicación	Front					Rear				
		Ultra	ProGuard\ Guardian	LTV\ Max Control	Protector de Strut\ Bases de Strut	HiJacker\ Soporte\ Hidráulico	Ultra	ProGuard\ Guardian	LTV\ Max Control	Protector de Strut\ Bases de Strut	HiJacker\ Soporte\ Hidráulico

NISSAN

NISSAN

ARMADA (cont)

05-06	Exc. Sistema de Autonivelación	G51715	143358 ⁵³	G63875
-------	--------------------------------	--------	------	------	----------------------	------	--------	------	------	------	------

ARMADA READYMOUNTS

		Delantero		Trasero	
12-15	4WD, Exc. Sistema De Autonivelacion	G57092		
05-11	4WD	G57092 ³		

AXXESS

91-94	Todos	142241 ⁵⁸	G44776 ⁹⁸
	Derecho	142241 ⁵⁸	G44776 ⁹⁸	142427 ⁵³
90-94	FWD, Izquierdo	G55607 ⁹	142241 ⁵⁸	G44776 ⁹⁸
	FWD, Derecho	G55608 ⁹	142241 ⁵⁸	G44776 ⁹⁸
90	Todos	142241 ⁵⁸
	Derecho	142241 ⁵⁸	142427 ⁵³

B210

74-78	Todos	G44752 ⁹⁸
	Exc. Hatchback	G44752 ⁹⁸	81501
	Hatchback	G44752 ⁹⁸	82020

CABSTAR

08-11	Todos	G64084
11	Todos	G64084	G64085
07-08	Todos	G64084	G64085

CUBE

14	Izquierdo	G52193
	Derecho	G52194
13	Izquierdo	G52193	G51976
	Derecho	G52194	G51976
12	Izquierdo	G52193	143516 ⁵³	G51976
	Derecho	G52194	143517 ⁵³	G51976
09-11	Izquierdo	143516 ⁵³	G51976
	Derecho	143517 ⁵³	G51976

3 Número de parte futuro

53 Montaje de Strut. Es probable reutilizar algunas partes del E.O.



98 Nota: El nivel de dificultad para instalar este producto es moderadamente alto. Por favor revise las instrucciones cuidadosamente antes de comenzar.

Texto en Negritas - Número de Parte Nuevo / Futuro

9 Vea Ref.D para los procedimientos de reemplazo de una Susp. Elect. Ajust. con un producto no ajust.

58 El Kit de Montaje incluye: Rodamiento de Suspensión. Es probable reutilizar algunas partes del E.O.

AMORTIGUADORES Y STRUTS

Año	Notas de Aplicación										
		Ultra	ProGuard\ Guardian	LTV\ Max Control	Protector de Strut\ Bases de Strut	HiJacker\ Soporte\ Hidráulico	Ultra	ProGuard\ Guardian	LTV\ Max Control	Protector de Strut\ Bases de Strut	HiJacker\ Soporte\ Hidráulico

NISSAN

NISSAN

CUBE READYMOUNTS

		Delantero	Trasero
09-14	Izquierdo	G57202⁴⁰
	Derecho	G57203⁴⁰

DATSUN

85-88	Todos	81494	81340
79-84	Todos	G44752	81494	81147 81340
65-78	Todos	81494	81340

EQUATOR

10-11	Todos	143379
-------	-------	------	------	------	--------	------	------	------	------	------	------

F10

76-78	Wagon	82125
-------	-------	------	------	------	------	------	------	-------	------	------	------

FRONTIER

14-16	Exc. Nismo Off-Road	G64031	
16	SV, Exc. Nismo Off-Road	G51766	
15	SL, Exc. Nismo Off-Road	G51766	
14	S, Exc. Nismo Off-Road	G51766	
13	Exc. Nismo Off-Road	G64031	
	Fab. hasta 12/12; Exc. Nismo Off-Road	G51766	
	Mfg. to 12/12; Exc. Nismo Offroad	143522	
05-12	Todos	143379	
	Exc. Nismo Off-Road	143379	G64031	
	Fab. hasta 12/12; Exc. Nismo Off-Road	G51766	143379	
	Mfg. to 12/12; Exc. Nismo Offroad	143522 143379	
98-04	4WD	G63813	61662	G63492	61506 81318	77492	49311 ⁷
	RWD, Exc. Desert Runner	G63909	61508 81507	77909	G63907	61500 81147	77907	43048 ⁸ 49310 ⁷ 70163
	RWD; Crew Cab con Desert Runner	G63813	61662	G63492	61506 81318	77492	49311 ⁷

FRONTIER ESTABILIZADORES DE DIRECCIÓN

		Delantero	Trasero
98	4WD	6863SE ⁸²

HIKARI

88-91	Todos	G55745	55745	G55746	55746
-------	-------	--------	------	------	------	-------	--------	------	------	------	------	-------

ICHIVAN

87-93	Todos	G64181	G63907	61500 81147	70163
-------	-------	--------	------	------	------	------	--------	----------------	------	------	------	-------





7 Paquetes en pares; kit de mangueras de aire incluido
40 Strut ReadyMount. Ensamble Completo

Texto en Negritas - Número de Parte Nuevo / Futuro

8 Paquetes en pares

82 Use kit si está señalado. Vea Ref. C para Botas.













AMORTIGUADORES Y STRUTS

Año	Notas de Aplicación										
			Ultra	ProGuard\ Guardian	LTV\ Max Control	Protector de Strut\ Bases de Strut	HiJacker\ Soporte\ Hidráulico		Ultra	ProGuard\ Guardian	LTV\ Max Control









NISSAN

NISSAN





JUKE

15-16	AWD			G511122
	FWD			G511123
11-14	Todos			G51989
	Derecho		G52452		G51989
14	AWD			G511122 G51989
	FWD			G511123 G51989











LEAF

13-16	Izquierdo		G52522		G511119
	Derecho		G52523		G511119
11-12	Izquierdo		G52522		G511042
	Derecho		G52523		G511042















LUCINO

95-00	Izquierdo		G55970		G51230
	Derecho		G55971		G51230

MARCH

12-15	Todos			70073
	Izquierdo Con barra estabilizadora		G52453		70073
	Derecho Con barra estabilizadora		G52454		70073
	Sin barra estabilizadora Izquierdo		G52339		70073
	Sin barra estabilizadora Derecho		G52340		70073

MAXIMA

15-16	Izquierdo		G52698	
	Derecho		G52699	
09-14	Izquierdo		G52382		70089
	Derecho		G52383		70089
14	Todos			70089
	Izquierdo		G52698		70089
	Derecho		G52699		70089

AMORTIGUADORES Y STRUTS

Año	Notas de Aplicación	Front					Rear				
		Ultra	ProGuard\ Guardian	LTV\ Max Control	Protector de Strut\ Bases de Strut	HiJacker\ Soporte\ Hidráulico	Ultra	ProGuard\ Guardian	LTV\ Max Control	Protector de Strut\ Bases de Strut	HiJacker\ Soporte\ Hidráulico

NISSAN

NISSAN

MAXIMA (cont)

04-08	Todos	142937 ⁵³	G51802	143214 ⁵³
	Kit w/ Mount and Bearing	142937 142937 ⁵³	G51802	143214 ⁵³
	Izquierdo	G56671	142937 ⁵³	G51802	143214 ⁵³
	Derecho	G56672	142937 ⁵³	G51802	143214 ⁵³
02-03	Izquierdo	G56685	142937 ⁵³	G51727	142949 ⁵³
	Derecho	G56686	142937 ⁵³	G51727	142949 ⁵³
00-03	Todos	142937 ⁵³	G51727	142949 ⁵³
	Kit w/ Mount and Bearing	142937 142937 ⁵³	G51727	142949 ⁵³
00-01	Izquierdo	G56683	142937 ⁵³	G51727	142949 ⁵³
	Derecho	G56684	142937 ⁵³	G51727	142949 ⁵³
95-99	Izquierdo	G55913	142546 ⁵⁴	G51087
	Derecho	G55912	142546 ⁵⁴	G51087
89-94	Izquierdo Exc. Suspensión Electrónica Ajustable	G55607 ⁹	142241 ⁵⁸	G44990 ⁹⁸
	Derecho Exc. Suspensión Electrónica Ajustable	G55608 ⁹	142241 ⁵⁸	G44990 ⁹⁸	142427 ⁵³
86-88	Sedan Exc. Suspensión Electrónica Ajustable	G55521	142242 ⁵³	G44776 ⁹⁸
	Sedan Derecho Exc. Suspensión Electrónica Ajustable	142427 ⁵³
85	Exc. Suspensión Electrónica Ajustable	142242 ⁵³	G44776 ⁹⁸
	Derecho Exc. Suspensión Electrónica Ajustable	142427 ⁵³
83-84	Wagon	G44869 ⁹⁸	142241 ⁵⁸	82156	49310 ⁷
82-84	Todos	G44869 ⁹⁸	142241 ⁵⁸
	Sedan	G44869 ⁹⁸	142241 ⁵⁸	G51229

MAXIMA READYMOUNTS

		Delantero	Trasero
04-08	Izquierdo	G57030 ⁴⁰
	Derecho	G57031 ⁴⁰
02-03	Standard Izquierdo	G57157 ⁴⁰
	Standard Derecho	G57158 ⁴⁰
00-03	Izquierdo	G57159
	Derecho	G57160
00-01	Standard Izquierdo	G57165 ⁴⁰
	Standard Derecho	G57166 ⁴⁰
95-99	Izquierdo	G56970 ⁴⁰	G57057 ⁴⁰
	Derecho	G56971 ⁴⁰	G57058 ⁴⁰

7 Paquetes en pares; kit de mangueras de aire incluido

40 Strut ReadyMount. Ensemble Completo

54 Kit con Montaje y Rodamiento. Es probable que reutilizar algunas partes del E.O.

98 Nota: El nivel de dificultad para instalar este producto es moderadamente alto. Por favor revise las instrucciones cuidadosamente antes de comenzar.





Texto en Negritas - Número de Parte Nuevo / Futuro

9 Vea Ref.D para los procedimientos de reemplazo de una Susp. Elect. Ajust. con un producto no ajust.

53 Montaje de Strut. Es probable reutilizar algunas partes del E.O.

58 El Kit de Montaje incluye: Rodamiento de Suspensión. Es probable reutilizar algunas partes del E.O.



AMORTIGUADORES Y STRUTS

Año	Notas de Aplicación										
			Ultra	ProGuard\ Guardian	LTV\ Max Control	Protector de Strut\ Bases de Strut	HiJacker\ Soporte\ Hidráulico		Ultra	ProGuard\ Guardian	LTV\ Max Control







NISSAN

NISSAN



















MICRA

04-07	Izquierdo		G52221		70014
	Derecho		G52222		70014

MULTI

87-88	Todos		G44767 ⁹⁸	142242 ⁵³ 142861 ⁵⁴		G44776 ⁹⁸	81554
	Derecho		G44767 ⁹⁸	142242 ⁵³ 142861 ⁵⁴		G44776 ⁹⁸	81554	142427 ⁵³
86	Todos		G44767 ⁹⁸	142861 ⁵⁴		G44766 ⁹⁸	81554



MURANO

15-16	Izquierdo		G52728	
	Derecho		G52727	
14-16	Exc. CrossCabriolet			G51884
11-14	SL, LE, S, SV Models Derecho		G52726	
	SL, LE, S, SV Models Izquierdo		G52725	
08-13	Fab. hasta 12/12 Exc. SE Models Izquierdo		G52170		G51884
	Fab. hasta 12/12 Exc. SE Models Derecho		G52171		G51884
03-07	Izquierdo		G52008	142937 ⁵³		G51798	143396
	Derecho		G52009	142937 ⁵³		G51798	143396





MURANO READYMOUNTS

		Delantero		Trasero	
03-07	Izquierdo	G57163		
	Derecho	G57164		





NISSAN SEDAN

79-84	Todos		G44752		81147
65-68	Todos		81494		81340



NOTE

14-16	Izquierdo		G52453		G51990
	Derecho		G52454		G51990

NV200

13-16	Izquierdo		G52591		G64146
	Derecho		G52592		G64146

NV350

13-15	Todos		G64184		G64185
-------	-------	---	--------	------	------	------	------	---	--------	------	------	------	------

53 Montaje de Strut. Es probable reutilizar algunas partes del E.O.

54 Kit con Montaje y Rodamiento. Es probable que reutilizar algunas partes del E.O.

98 Nota: El nivel de dificultad para instalar este producto es moderadamente alto. Por favor revise las instrucciones cuidadosamente antes de comenzar.

AMORTIGUADORES Y STRUTS

Año	Notas de Aplicación	Front					Rear				
		Ultra	ProGuard\ Guardian	LTV\ Max Control	Protector de Strut\ Bases de Strut	HiJacker\ Soporte\ Hidráulico	Ultra	ProGuard\ Guardian	LTV\ Max Control	Protector de Strut\ Bases de Strut	HiJacker\ Soporte\ Hidráulico

NISSAN

NISSAN

NV1500

12-16	Todos	G511124	G64164
-------	-------	---------	------	------	------	------	--------	------	------	------	------

NX

91-93	Todos	55745
	Izquierdo	G55745	142623 ⁵⁴	55745	G55977	142302 ⁵³
	Derecho	G55745	142623 ⁵⁴	55745	G55976	142302 ⁵³

PATHFINDER





13-16	Izquierdo	G52524	G511043
	Derecho	G52525	G511043
12-13	Fab. hasta 09/12	G64033
12	Fab. hasta 8/12	G51765
05-11	Todos	143379
	Fab. hasta 09/12	143379	G64033
	Fab. hasta 8/12	G51765	143379
04	Todos	G63845
	Izquierdo With EO# 543034W925 or 543034W926	G56687	G63845
	Derecho With EO# 543034W925 or 543034W926	G56688	G63845
02-03	Todos	142938 ⁵³	G63845
	Izquierdo With EO# 543034W925 or 543034W926	G56687	142938 ⁵³	G63845
	Derecho With EO# 543034W925 or 543034W926	G56688	142938 ⁵³	G63845
99-01	Fab. desde 12/98	142938 ⁵³	G63845
	Izquierdo With EO# 543034W985	G56615	142938 ⁵³
	Derecho With EO# 543034W985	G56616	142938 ⁵³
96-01	Todos	142938 ⁵³	
01	Izquierdo With EO# 543034W925 or 543034W926	G56687	142938 ⁵³
	Derecho With EO# 543034W925 or 543034W926	G56688	142938 ⁵³
96-99	Fab. hasta 12/98	142938 ⁵³	G63712	61609 81910
	Fab. hasta 12/98 Izquierdo	G56739	142938 ⁵³
	Fab. hasta 12/98 Derecho	G56736	142938 ⁵³
87-95	Todos	81872
	Exc. Suspensión Electrónica Ajustable	G63904 ⁹	61593 ⁹ 81872	77904 ⁹	G63492 ⁹	61506 ⁹ 81318 ⁹	77492 ⁹	49311 ⁷

7 Paquetes en pares; kit de mangueras de aire incluido
53 Montaje de Strut. Es probable reutilizar algunas partes del E.O.

9 Vea Ref.D para los procedimientos de reemplazo de una Susp. Elect. Ajust. con un producto no ajust.

54 Kit con Montaje y Rodamiento. Es probable que reutilizar algunas partes del E.O.

AMORTIGUADORES Y STRUTS









Año	Notas de Aplicación										
			Ultra	ProGuard\ Guardian	LTV\ Max Control	Protector de Strut\ Bases de Strut	HiJacker\ Soporte\ Hidráulico		Ultra	ProGuard\ Guardian	LTV\ Max Control

NISSAN

NISSAN

		PATHFINDER ESTABILIZADORES DE DIRECCIÓN	
		Delantero	Trasero
87-95	4WD	6848SE ⁸²
		PATHFINDER READYMOUNTS	
		Delantero	Trasero
05-11	4WD	G57118
02-04	Izquierdo	G57144 ⁴⁰
	Derecho	G57145 ⁴⁰
99	Fab. hasta 11/98 Izquierdo	G57037 ⁴⁰
	Fab. hasta 11/98 Derecho	G57038 ⁴⁰
98	Fabricado antes de Nov/98 Izquierdo	G57037 ⁴⁰
	Fabricado antes de Nov/98 Derecho	G57038 ⁴⁰
96-97	Fab. hasta 11/98 Izquierdo	G57037 ⁴⁰
	Fab. hasta 11/98 Derecho	G57038 ⁴⁰

PICKUP

09-14	Todos Inc. NP 300		G63902	61501 81478	77902	70161		G63907	61500 81147	77907	70163
94-08	Todos		G63902	61501 81478	77902	70161 42972		G63907	61500 81147	77907	70163 42973
			G63902	61501 81478	77902	70161 42972		G63907	61500 81147	77907	70163 42973
65-93	D21 RWD, Estacas Nacional		G63902	61501 81478	77902	42972		G63491	61505 81097	42970





7 Paquetes en pares; kit de mangueras de aire incluido
40 Strut ReadyMount. Ensamble Completo

Texto en Negritas - Número de Parte Nuevo / Futuro

8 Paquetes en pares

82 Use kit si está señalado. Vea Ref. C para Botas.

AMORTIGUADORES Y STRUTS

Año	Notas de Aplicación										
			Ultra	ProGuard\ Guardian	LTV\ Max Control	Protector de Strut\ Bases de Strut	HiJacker\ Soporte\ Hidráulico		Ultra	ProGuard\ Guardian	LTV\ Max Control

NISSAN

NISSAN

PICKUP (cont)

PICKUP ESTABILIZADORES DE DIRECCIÓN

		Delantero	Trasero
84-97	4WD; Estabilizador de direccion	6848SE





PLATINA

02-10	Todos		G56648		G51706
-------	-------	---	--------	------	------	------	------	---	--------	------	------	------	------

PULSAR / PULSAR NX

87-90	Todos		55745		55746
-------	-------	---	------	------	------	------	-------	---	------	------	------	------	-------















AMORTIGUADORES Y STRUTS

Año	Notas de Aplicación										
			Ultra	ProGuard\ Guardian	LTV\ Max Control	Protector de Strut\ Bases de Strut	HiJacker\ Soporte\ Hidráulico		Ultra	ProGuard\ Guardian	LTV\ Max Control























NISSAN

PULSAR / PULSAR NX (cont)

NISSAN

87-90	Todos		G55745	142861 ⁵⁴	55745		G55746	55746
86	Todos		55745	
	Todos		142861 ⁵⁴	55745	
	Fab. desde 1/86		G55745	55745		G55746	81508
	Fab. hasta 1/86		G55713 ⁹	55745	
	Fabricado desde Ene/86		55745		55746
83-85	Todos		G55713 ⁹	142241 ⁵⁸		81508













QUEST

14-16	Izquierdo		G52906		70077
	Derecho		G52907		70077
11-13	Izquierdo		G52355		70077
	Derecho		G52356		70077
04-09	Todos		142937 ⁵³		G51803	143396
	Izquierdo		G52032	142937 ⁵³		G51803	143396
	Derecho		G52033	142937 ⁵³		G51803	143396
99-02	Izquierdo		G56785	142241 ⁵⁸ 142860 ⁵⁴		G63299	61637
	Derecho		G56784	142241 ⁵⁸ 142860 ⁵⁴		G63299	61637
93-98	Izquierdo		G55920	142241 ⁵⁸ 142860 ⁵⁴		G63299	61637
	Derecho		G55921	142241 ⁵⁸ 142860 ⁵⁴		G63299	61637

QUEST READYMOUNTS

		Delantero	Trasero
93-98	Izquierdo	G56989 ⁴⁰
	Derecho	G56990 ⁴⁰

ROGUE

12-16	Izquierdo		G52410		G64050
	Derecho		G52411		G64050
08-16	Todos			G64050
12-13	Modelos S y SL Izquierdo		G52418		G64050
	Modelos S y SL Derecho		G52419		G64050
08-12	Izquierdo con EO# E4303JM00A		G52173		G64050

9 Vea Ref.D para los procedimientos de reemplazo de una Susp. Elect. Ajust. con un producto no ajust.

53 Montaje de Strut. Es probable reutilizar algunas partes del E.O.



58 El Kit de Montaje incluye: Rodamiento de Suspensión. Es probable reutilizar algunas partes del E.O.

Texto en Negritas - Número de Parte Nuevo / Futuro

40 Strut ReadyMount. Ensemble Completo

54 Kit con Montaje y Rodamiento. Es probable que reutilizar algunas partes del E.O.

AMORTIGUADORES Y STRUTS

Año	Notas de Aplicación										
		Ultra	ProGuard\ Guardian	LTV\ Max Control	Protector de Strut\ Bases de Strut	HiJacker\ Soporte\ Hidráulico	Ultra	ProGuard\ Guardian	LTV\ Max Control	Protector de Strut\ Bases de Strut	HiJacker\ Soporte\ Hidráulico

NISSAN

NISSAN

ROGUE (cont)

08-12	Derecho With EO# E4302JM00A	G52174	G64050
-------	-----------------------------	--------	------	------	------	------	--------	------	------	------	------

SAKURA

86-87	1.8L 4Cyl (107) 2BBL	G44934	81671
82-85	1.8L 4Cyl (107) 2BBL	G44752	81501

SAMURAI

79-84	1.8L 4Cyl (107) 2BBL	G44752	81501
-------	----------------------	--------	------	------	------	------	-------	------	------	------	------

SENTRA





13-15	Izquierdo	G52528	G511044
	Derecho	G52529	G511044
07-12	Modelos Base, S y SL Izquierdo	G52094	70027
	Modelos Base, S y SL Derecho	G52095	70027
07-10	Izquierdo	143377 ⁵³
	Derecho	143378 ⁵³
05-06	GXE, GXE Sport, XE, Izquierdo	G56806	143322 ⁵³	G51279	143209 ⁵³
	GXE, GXE Sport, XE, Derecho	G56805	143322 ⁵³	G51279	143209 ⁵³
02-06	SE-R, SE-R Spec V, Izquierdo	G52055
	SE-R, SE-R Spec V, Derecho	G52056
03-04	GXE, GXE Sport, LE, XE, Izquierdo	G56806	143322 ⁵³	G51279	143209 ⁵³
	GXE, GXE Sport, LE, XE, Derecho	G56805	143322 ⁵³	G51279	143209 ⁵³
02	CA, GXE, GXE Sport, XE, Izquierdo	G56806	143322 ⁵³	G51279	143209 ⁵³
	CA, GXE, GXE Sport, XE, Derecho	G56805	143322 ⁵³	G51279	143209 ⁵³
00-01	Izquierdo	G56618	142936 ⁵³	G51279	143209 ⁵³
	Derecho	G56619	142936 ⁵³	G51279	143209 ⁵³
95-00	Izquierdo Eje Trasero Rígido B14	G55970	142623 ⁵⁴ 143057 ⁵¹	G51230	142646 ⁵³
	Derecho Eje Trasero Rígido B14	G55971	142623 ⁵⁴ 143057 ⁵¹	G51230	142646 ⁵³

53 Montaje de Strut. Es probable reutilizar algunas partes del E.O.

54 Kit con Montaje y Rodamiento. Es probable que reutilizar algunas partes del E.O.

Texto en Negritas - Número de Parte Nuevo / Futuro































AMORTIGUADORES Y STRUTS

Año	Notas de Aplicación										
			Ultra	ProGuard\ Guardian	LTV\ Max Control	Protector de Strut\ Bases de Strut	HiJacker\ Soporte\ Hidráulico		Ultra	ProGuard\ Guardian	LTV\ Max Control

NISSAN

NISSAN

















SENTRA (cont)

93-94	Todos		142623 ⁵⁴ 143057 ⁵¹		142302 ⁵³
	Izquierdo Suspensión Trasera Independiente B13		G55657	142623 ⁵⁴		142302 ⁵³
	Derecho Suspensión Trasera Independiente B13		G55658	142623 ⁵⁴		142302 ⁵³
	Non-ABS Izquierdo Suspensión Trasera Independiente B13		142623 ⁵⁴		G55977	142302 ⁵³
	Non-ABS Derecho Suspensión Trasera Independiente B13		142623 ⁵⁴		G55976	142302 ⁵³
91-92	CAN, FWD		55745		55746
	Classic, FWD		142861 ⁵⁴	55745	
	FWD		55745		G55746
	Non-ABS		G55745	142623 ⁵⁴	55745		142302 ⁵³
	Non-ABS Izquierdo Suspensión Trasera Independiente B13		55745		G55977
	Non-ABS Derecho Suspensión Trasera Independiente B13		55745		G55976
87-92	Todos		55745	
87-90	FWD		G55745	142861 ⁵⁴	55745		G55746
	FWD		55745		55746
82-86	Todos		G55713 ⁹		81508

SENTRA READYMOUNTS

		Delantero	Trasero
02-06	Izquierdo	G57034 ⁴⁰	G57036 ⁴⁰
	Derecho	G57035 ⁴⁰	G57036 ⁴⁰

STANZA

90-92	Izquierdo		G55610		G44990 ⁹
	Derecho		G55611		G44990 ⁹	142427 ⁵³
87-89	Sedan		G55521	142242 ⁵³ 142861 ⁵⁴		G44776 ⁹⁸
	Sedan Derecho			142427 ⁵³
87-88	FWD, Wagon			81554
85-86	Sedan		G44767 ⁹⁸	142861 ⁵⁴		G44766 ⁹⁸
82-86	Todos		G44767 ⁹⁸		G44766 ⁹⁸
86	FWD, Wagon		G44767 ⁹⁸		G44766 ⁹⁸	81554

9 Vea Ref.D para los procedimientos de reemplazo de una Susp. Elect. Ajust. con un producto no ajust.

53 Montaje de Strut. Es probable reutilizar algunas partes del E.O.

98 Nota: El nivel de dificultad para instalar este producto es moderadamente alto. Por favor revise las instrucciones cuidadosamente antes de comenzar.

Texto en Negritas - Número de Parte Nuevo / Futuro

40 Strut ReadyMount. Ensamble Completo

54 Kit con Montaje y Rodamiento. Es probable que reutilizar algunas partes del E.O.

AMORTIGUADORES Y STRUTS

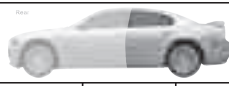
Año	Notas de Aplicación										
		Ultra	ProGuard\ Guardian	LTV\ Max Control	Protector de Strut\ Bases de Strut	HiJacker\ Soporte\ Hidráulico	Ultra	ProGuard\ Guardian	LTV\ Max Control	Protector de Strut\ Bases de Strut	HiJacker\ Soporte\ Hidráulico

NISSAN

NISSAN

STATION WAGON

82-83	1.8L 4Cyl (107) 2BBL	81492
73-83	1.6L 4Cyl (97) 1BBL	81492
65-71	1.6L 4Cyl (97) 1BBL	81494	82155

TIIDA

06-13	Izquierdo	G52193	143516 ⁵³	70041
	Derecho	G52194	143517 ⁵³	70041

TIIDA READYMOUNTS

		Delantero	Trasero
06-13	Derecho	G57203 ⁴⁰
	Izquierdo	G57202 ⁴⁰

TITAN

16	Todos	G511130
12-15	Todos	G51715
	4WD	G51715	G63878
	RWD	G51715	G63883
04-11	Todos	G51715	143358 ⁵³ 143359 ⁷⁰
	4WD	G51715	143358 ⁵³ 143359 ⁷⁰	G63878
	RWD	G51715	143358 ⁵³ 143359 ⁷⁰	G63883

TITAN READYMOUNTS

		Delantero	Trasero
04-11	4WD, Exc. Offroad Package	G57092 ³

TSUBAME





92-05	Izquierdo	G55657	55657	82156
	Derecho	G55658	55658	82156

3 Número de parte futuro
70 Kit Buje y Camisa. Algunos accesorios del Equipo Original podrían ser necesitados

Texto en Negritas - Número de Parte Nuevo / Futuro

53 Montaje de Strut. Es probable reutilizar algunas partes del E.O.













AMORTIGUADORES Y STRUTS

Año	Notas de Aplicación										
		 Ultra	ProGuard\ Guardian	LTV\ Max Control	Protector de Strut\ Bases de Strut	HiJacker\ Soporte\ Hidráulico	 Ultra	ProGuard\ Guardian	LTV\ Max Control	Protector de Strut\ Bases de Strut	HiJacker\ Soporte\ Hidráulico

NISSAN

NISSAN





TSURU

92-18	GS y III Izquierdo		G55657	55657		G55977	55977
	GS y III Derecho		G55658	55658		G55976	55976
88-91	II		G55745	55745		G55746	55746
84-87	I		G55713	55713		81508	42508
	Ninja		G55713	55713		81508	42508
	Samurai		G55713	55713		81508	42508





URVAN

00-13	Todos		69580	70159		G63907	61500 81147	70163
-------	-------	---	-------	------	------	------	-------	---	--------	----------------	------	------	-------



VERSA

12-15	Izquierdo		G52453		G51990
	Derecho		G52454		G51990

X-TRAIL

08-12	Izquierdo		G52173		G64050
	Derecho		G52174		G64050





AMORTIGUADORES Y STRUTS

Año	Notas de Aplicación										
		Ultra	ProGuard\ Guardian	LTV\ Max Control	Protector de Strut\ Bases de Strut	HiJacker\ Soporte\ Hidráulico	Ultra	ProGuard\ Guardian	LTV\ Max Control	Protector de Strut\ Bases de Strut	HiJacker\ Soporte\ Hidráulico























NISSAN

NISSAN

X-TRAIL (cont)

00-07	Izquierdo		G52000	143346		G52002
	Derecho		G52001	143346		G52003















XTERRA

14-15	Todos		G51765	
13	4WD; Fab. hasta 12/12			69595
	Fab. hasta 12/12		G51765	
	RWD; Fab. hasta 12/12			69594
11-12	RWD; Fab. hasta 12/12		143379		69594
05-12	Todos		143379	
	4WD; Fab. hasta 12/12		143379		69595
	Fab. hasta 12/12		G51765	143379	
08-10	RWD		143379		69594
05-07	RWD, 5.0l 8 Cyl V		143379		69594
00-04	Todos		G63813	61662		G63492	61506	77492

OLDSMOBILE

OLDSMOBILE

88 SERIES

97-99	Todos		G56718 ⁹	142524 ⁵⁸ 142751 ⁶⁵		142132 ⁵³
	Reemplazo Tipo Convencional para Susp. Trasera Asistida por Aire		G56718 ⁹	142524 ⁵⁸ 142751 ⁶⁵		G56707 ⁹	142132 ⁵³
	Coil(RearSpringType), Coil(FrontSpringType) Sistema de Autonivelación NIVOMAT de EO opcional Exc. Suspensión Elect. Ajustable		G56718 ⁹	142524 ⁵⁸ 142751 ⁶⁵		G56903 ⁹	142132 ⁵³
94-96	Coil(RearSpringType), Coil(FrontSpringType) Sistema de Autonivelación NIVOMAT de EO opcional Exc. Suspensión Elect. Ajustable		G56718 ⁹	142226 ⁵⁴ 142227 ⁵⁸ 142751 ⁶⁵		G56903 ⁹	142132 ⁵³
	Todos		G56718 ⁹	142226 ⁵⁴ 142227 ⁵⁸ 142751 ⁶⁵		142132 ⁵³
92-96	Reemplazo Tipo Convencional para Susp. Trasera Asistida por Aire		G56718 ⁹	142226 ⁵⁴ 142227 ⁵⁸ 142751 ⁶⁵		G56707 ⁹	142132 ⁵³
	Air(RearSpringType), Coil(FrontSpringType) Sistema de Autonivelación NIVOMAT de EO opcional Exc. Suspensión Elect. Ajustable		G56718 ⁹	142226 ⁵⁴ 142227 ⁵⁸ 142751 ⁶⁵		G56903 ⁹	142132 ⁵³

9 Vea Ref.D para los procedimientos de reemplazo de una Susp. Elect. Ajust. con un producto no ajust.

54 Kit con Montaje y Rodamiento. Es probable que reutilizar algunas partes del E.O.

65 El Kit de Montaje incluye: Asiento de Resorte Superior con Aislador. Es probable reutilizar algunas partes del E.O.

53 Montaje de Strut. Es probable reutilizar algunas partes del E.O.

58 El Kit de Montaje incluye: Rodamiento de Suspensión. Es probable reutilizar algunas partes del E.O.

AMORTIGUADORES Y STRUTS

Año	Notas de Aplicación	Front					Rear				
		Ultra	ProGuard\ Guardian	LTV\ Max Control	Protector de Strut\ Bases de Strut	HiJacker\ Soporte\ Hidráulico	Ultra	ProGuard\ Guardian	LTV\ Max Control	Protector de Strut\ Bases de Strut	HiJacker\ Soporte\ Hidráulico

OLDSMOBILE

OLDSMOBILE

88 SERIES (cont)

90-91	Todos	142226 ⁵⁴ 142227 ⁵⁸ 142751 ⁵⁵
	Sistema de Autonivelación NIVOMAT de EO opcional	142226 ⁵⁴ 142227 ⁵⁸ 142751 ⁵⁵	142132 ⁵³
	Strut Delantero de Segundo Diseño sin Resorte de Seguridad	G56718 ⁸	142226 ⁵⁴ 142227 ⁵⁸ 142751 ⁵⁵
	Air(RearSpringType) Sistema de Autonivelación NIVOMAT de EO opcional	142226 ⁵⁴ 142227 ⁵⁸ 142751 ⁵⁵	G56903
	Coil(RearSpringType)	142226 ⁵⁴ 142227 ⁵⁸ 142751 ⁵⁵	G56707 ⁹
90	Strut Delantero de Diseño Inicial c/ Resorte de Seguridad	G56701	142226 ⁵⁴ 142227 ⁵⁸ 142751 ⁵⁵
86-89	Todos	142227 ⁵⁸ 142752 ⁵⁵
	Sistema de Autonivelación NIVOMAT de EO opcional	142227 ⁵⁸ 142752 ⁵⁵	142132 ⁵³
	Strut Delantero de Diseño Inicial c/ Resorte de Seguridad	G56701	142227 ⁵⁸ 142752 ⁵⁵
	Air(RearSpringType) Sistema de Autonivelación NIVOMAT de EO opcional	142227 ⁵⁸ 142752 ⁵⁵	G56903
	Coil(RearSpringType)	142227 ⁵⁸ 142752 ⁵⁵	G56707 ⁹
71-85	Todos	69675 ⁵	81446	34073 ⁸	69724	81514	43049 ⁸ 49131 ³⁰
65-70	Todos	82110	69724	81514	43049 ⁸ 49128 ³⁰
63-64	Todos	82079	82089
59-62	Todos	82079
58	Exc. Suspensión de Aire '58	82079
57	Todos	82079

88 SERIES READYMOUNTS

		Delantero	Trasero
94-99	Coil(RearSpringType) Sistema de Autonivelación NIVOMAT de EO opcional Exc. Suspensión Elect. Ajustable	G56909⁴	G56906¹³
92-99	Todos	G56909⁴
	Coil(RearSpringType) Exc. Suspensión Electrónica Ajustable	G56909⁴	G56726 ¹³
92-93	Air(RearSpringType) Sistema de Autonivelación NIVOMAT de EO opcional Exc. Suspensión Elect. Ajustable	G56909⁴	G56906¹³
90-91	Strut Delantero de Diseño Tardío sin Resorte de Seguridad	G56909⁴
86-91	Coil(RearSpringType)	G56726 ¹³
91	Air(RearSpringType) Sistema de Autonivelación NIVOMAT de EO opcional Exc. Suspensión Elect. Ajustable	G56906¹³
86-90	Strut Delantero de Diseño Inicial c/ Resorte de Seguridad	G56914⁴⁰
	Air(RearSpringType) Sistema de Autonivelación NIVOMAT de EO opcional	G56906¹³

98

91-96	Todos	142226 ⁵⁴	142132 ⁵³
	Exc. Suspensión Soft Ride (FE1) y Elect. Ride y Handling (FW1)	142227 ⁵⁸ 142751 ⁵⁵ 142226 ⁵⁴	142132 ⁵³

4 Número de futuro, las cantidades disponibles Q4 2016.

8 Paquetes en pares

30 Para Vehículos GM equipados con sistemas de nivelación de fábrica, vea Ref. A.

43 Strut ReadyMount, no incluye resortes por el diseño del vehículo. Consulte la Ref. D

para el procedimiento de reemplazo en una Susp. Elec. Ajustable con un producto no ajustable

54 Kit con Montaje y Rodamiento. Es probable que reutilizar algunas partes del E.O.

65 El Kit de Montaje incluye: Asiento de Resorte Superior con Aislador. Es probable reutilizar algunas partes del E.O.

reutilizar algunas partes del E.O.

reutilizar algunas partes del E.O.

Texto en Negritas - Número de Parte Nuevo / Futuro

5 Use el kit 140719 para reemplazar partes del EO de montaje inferior cuando los pernos se rompan o los tornillos autoroscantes no se puedan utilizar más.

9 Vea Ref.D para los procedimientos de reemplazo de una Susp. Elect. Ajust. con un producto no ajust.

40 Strut ReadyMount. Ensamble Completo

53 Montaje de Strut. Es probable reutilizar algunas partes del E.O.

58 El Kit de Montaje incluye: Rodamiento de Suspensión. Es probable reutilizar algunas partes del E.O.

reutilizar algunas partes del E.O.

reutilizar algunas partes del E.O.

AMORTIGUADORES Y STRUTS

Año	Notas de Aplicación	Front					Rear				
		Ultra	ProGuard\ Guardian	LTV\ Max Control	Protector de Strut\ Bases de Strut	HiJacker\ Soporte\ Hidráulico	Ultra	ProGuard\ Guardian	LTV\ Max Control	Protector de Strut\ Bases de Strut	HiJacker\ Soporte\ Hidráulico

OLDSMOBILE

OLDSMOBILE

98 (cont)

91-96	Manejo con Comando Computarizado (CCR)	G56718 ⁹	142226 ⁵⁴	142132 ⁵³
	Air(RearSpringType) Manejo con Comando Computarizado (CCR)	142226 ⁵⁴	G56903	142132 ⁵³
	Air(RearSpringType) Reemplazo Tipo Convencional	142226 ⁵⁴	G56707 ⁹	142132 ⁵³
	Air(RearSpringType), Coil(FrontSpringType) Equipamiento Estándar; Exc. Suspensión Elec. Ajustable	142751 ⁶⁵ 142226 ⁵⁴	142132 ⁵³
85-90	Todos	G56701	142227 ⁵⁸ 142752 ⁶⁵	142132 ⁵³
	Air(RearSpringType)	G56701	142227 ⁵⁸ 142752 ⁶⁵	G56903	142132 ⁵³
	Air(RearSpringType) Reemplazo Tipo Convencional	G56701	142227 ⁵⁸ 142752 ⁶⁵	G56707 ⁹	142132 ⁵³
71-84	Todos	69675 ⁵	81446	34073 ⁸	69724	81514	43049 ⁸ 49131 ³⁰
65-70	Todos	82110	69724	81514	49128 ³⁰
63-64	Todos	82079	82089
59-62	Todos	82079
58	Exc. Suspensión de Aire '58	82079
56	Todos	82156
55	Todos	82026	82156
51-54	Todos	82156

98 READYMOUNTS

		Delantero		Trasero	
91-96	Todos	G56909⁴		
	Air(RearSpringType) Manejo con Comando Computarizado (CCR)	G56909⁴		G56906⁴³	
	Air(RearSpringType) Reemplazo Convencional	G56909⁴		G56726 ⁴³	
85-90	Todos	G56914⁴⁰		
	Air(RearSpringType)	G56914⁴⁰		G56906⁴³	
	Air(RearSpringType) Reemplazo Convencional	G56914⁴⁰		G56726 ⁴³	

ACHIEVA

95-98	Izquierdo Exc. Suspensión Electrónica Ajustable	G56720	142227 ⁵⁸	69407 ⁹	81790	141974 ⁵³	49614 ⁷
	Derecho Exc. Suspensión Electrónica Ajustable	G56719	142227 ⁵⁸	69407 ⁹	81790	141974 ⁵³	49614 ⁷
92-94	Todos	49371 ⁷
	Exc. FE3 y Control de Manejo Electrónico	69749	81530	49371 ⁷
	Exc. Suspensión Electrónica Ajustable	141974 ⁵³	49371 ⁷
	Izquierdo Exc. FE3 y Control de Manejo Electrónico	G56720	49371 ⁷
	Izquierdo Suspensión FE3	G56723	49371 ⁷

4 Número de futuro, las cantidades disponibles Q4 2016.

7 Paquetes en pares; kit de mangueras de aire incluido

9 Vea Ref.D para los procedimientos de reemplazo de una Susp. Elec. Ajust. con un producto no ajust.

40 Strut ReadyMount. Ensamble Completo

53 Montaje de Strut. Es probable reutilizar algunas partes del E.O.

58 El Kit de Montaje incluye: Rodamiento de Suspensión. Es probable reutilizar algunas partes del E.O.

5 Use el kit 140719 para reemplazar partes del EO de montaje inferior cuando los pernos se rompan o los tornillos autoroscantes no se puedan utilizar más.

8 Paquetes en pares





30 Para Vehículos GM equipados con sistemas de nivelación de fábrica, vea Ref. A. 43 Strut ReadyMount, no incluye resortes por el diseño del vehículo. Consulte la Ref. D para el procedimiento de reemplazo en una Susp. Elec. Ajustable con un producto no ajustable

54 Kit con Montaje y Rodamiento. Es probable que reutilizar algunas partes del E.O.

65 El Kit de Montaje incluye: Asiento de Resorte Superior con Aislador. Es probable reutilizar algunas partes del E.O.

Texto en Negritas - Número de Parte Nuevo / Futuro







AMORTIGUADORES Y STRUTS

Año	Notas de Aplicación										
			Ultra	ProGuard\ Guardian	LTV\ Max Control	Protector de Strut\ Bases de Strut	HiJacker\ Soporte\ Hidráulico		Ultra	ProGuard\ Guardian	LTV\ Max Control

OLDSMOBILE

OLDSMOBILE



ACHIEVA (cont)

92-94	Derecho Exc. FE3 y Control de Manejo Electrónico		G56719		49371 ⁷
	Derecho Suspensión FE3		G56724		49371 ⁷
	Suspensión FE3		142227 ⁵⁸		49371 ⁷

ACHIEVA READYMOUNTS

		Delantero		Trasero	
97-98	Izquierdo Exc. Suspensión Electrónica Ajustable	G56917 ⁴⁰		
	Derecho Exc. Suspensión Electrónica Ajustable	G56916 ⁴⁰		
95-96	Izquierdo	G56917 ⁴⁰		
	Derecho	G56916 ⁴⁰		
92-94	Izquierdo Exc. FE3 y Control de Manejo Electrónico	G56919 ⁴⁰		

























ALERO

99-04	Todos		G55974		G56501	142532 ⁵³
-------	-------	---	--------	------	------	------	------	---	--------	------	------	----------------------	------

ALERO READYMOUNTS

		Delantero		Trasero	
99-04	Todos	G56927 ⁴⁰		G56928 ⁴⁰	



AURORA

01-03	Todos		G56509	142640 ⁵⁴		142647 ⁵³
	Con Entradas de Aire de EO		G56509	142640 ⁵⁴		142647 ⁵³	49255
	Debe usarse con el kit de mangueras incluido		G56509	142640 ⁵⁴		142647 ⁵³	49228 ⁹⁰
98-99	Todos		G56509	142640 ⁵⁴		142647 ⁵³
	Con Entradas de Aire de EO		G56509	142640 ⁵⁴		142647 ⁵³	49255
	Debe usarse con el kit de mangueras incluido		G56509	142640 ⁵⁴		142647 ⁵³	49228 ⁹⁰
97	Todos		G55878	142524 ⁵⁸		142647 ⁵³
	Con Entradas de Aire de EO		G55878	142524 ⁵⁸		142647 ⁵³	49255
	Debe usarse con el kit de mangueras incluido		G55878	142524 ⁵⁸		142647 ⁵³	49228 ⁹⁰
95-96	Todos		G56718 ⁹	142227 ⁵⁸ 142751 ⁶⁵		142647 ⁵³
	Con Entradas de Aire de EO		G56718 ⁹	142227 ⁵⁸ 142751 ⁶⁵		142647 ⁵³	49255
	Debe usarse con el kit de mangueras incluido		G56718 ⁹	142227 ⁵⁸ 142751 ⁶⁵		142647 ⁵³	49228 ⁹⁰

AURORA READYMOUNTS

		Delantero		Trasero	
01-03	Exc. Suspensión Electrónica Ajustable	G57051 ⁴⁰		
98-99	Exc. Suspensión Electrónica Ajustable	G57051 ⁴⁰		

BRAVADA

02-04	Todos		G51718	143241 ⁵³		61717
-------	-------	---	--------	------	------	----------------------	------	---	------	-------	------	------	------

7 Paquetes en pares; kit de mangueras de aire incluido

30 Para Vehículos GM equipados con sistemas de nivelación de fábrica, vea Ref. A.

53 Montaje de Strut. Es probable reutilizar algunas partes del E.O.

58 El Kit de Montaje incluye: Rodamiento de Suspensión. Es probable reutilizar algunas partes del E.O.

9 Vea Ref.D para los procedimientos de reemplazo de una Susp. Elect. Ajust. con un producto no ajust.

40 Strut ReadyMount. Ensamble Completo

54 Kit con Montaje y Rodamiento. Es probable que reutilizar algunas partes del E.O.

65 El Kit de Montaje incluye: Asiento de Resorte Superior con Aislador. Es probable reutilizar algunas partes del E.O.

Texto en Negritas - Número de Parte Nuevo / Futuro

AMORTIGUADORES Y STRUTS

Año	Notas de Aplicación	Front					Rear				
		Ultra	ProGuard\ Guardian	LTV\ Max Control	Protector de Strut\ Bases de Strut	HiJacker\ Soporte\ Hidráulico	Ultra	ProGuard\ Guardian	LTV\ Max Control	Protector de Strut\ Bases de Strut	HiJacker\ Soporte\ Hidráulico

OLDSMOBILE

OLDSMOBILE

BRAVADA (cont)

02-04	Coil(RearSpringType)	↓	G51718	143241 ⁵³	○	G63842	61717
96-01	Todos	○	G63423	61531 81516	58423 77423	○	G63422	61528 81482	58422 77422	43162 ⁸ 49213 ⁷
91-94	Todos	○	G63423	61531 81516	58423 77423	○	G63422	61528 81482	58422 77422	43162 ⁸ 49213 ⁷
	Barra de Torsion(FrontSpringType)	○	G63423	61531 81516	58423 77423	142316 ⁵³	○	G63422	61528 81482	58422 77422	43162 ⁸ 49213 ⁷

BRAVADA READYMOUNTS

		Delantero	Trasero
02-04	Todos	G57022⁴⁰

CALAIS

87	Izquierdo	↓	G56706	142762 ⁶⁵	↓	69749	81530	141974 ⁵³	49371 ⁷
	Derecho	↓	G56705	142762 ⁶⁵	↓	69749	81530	141974 ⁵³	49371 ⁷
85-86	Todos	↓	142762 ⁶⁵	↓	69749	81530	141974 ⁵³	49371 ⁷
	Izquierdo Struts de EO no reconstruibles	↓	G56706	142762 ⁶⁵	↓	69749	81530	141974 ⁵³	49371 ⁷
	Derecho Struts de EO no reconstruibles	↓	G56705	142762 ⁶⁵	↓	69749	81530	141974 ⁵³	49371 ⁷
	Struts Reconstruibles de EO	↓	G44451 ⁹⁸	142762 ⁶⁵	↓	69749	81530	141974 ⁵³	49371 ⁷

CIERA / CUTLASS CIERA

85-96	Todos	↓	142749 ⁶⁵	↓
	Exc. Suspensión Electrónica Ajustable	↓	G55514	142223 ⁵³ 142749 ⁶⁵	↓	69723 ⁹	81517	141974 ⁵³	49370 ³⁰
	Exc. Suspensión Electrónica Ajustable	↓	142749 ⁶⁵	↓	42517
84	Todos	↓	142223 ⁵³ 142749 ⁶⁵	↓	141974 ⁵³	49370 ³⁰
	Exc. Suspensión Electrónica Ajustable	↓	142223 ⁵³ 142749 ⁶⁵	↓	69723 ⁹	81517	141974 ⁵³	49370 ³⁰
	Exc. Suspensión HD	↓	G55505	142223 ⁵³ 142749 ⁶⁵	↓	141974 ⁵³	49370 ³⁰
	Suspensión HD	↓	G55514	142223 ⁵³ 142749 ⁶⁵	↓	141974 ⁵³	49370 ³⁰
	Exc. Suspensión Electrónica Ajustable	↓	142223 ⁵³ 142749 ⁶⁵	↓	141974 ⁵³	42517 49370 ³⁰
82-83	Todos	↓	G55505	142223 ⁵³ 142749 ⁶⁵	↓	49370 ³⁰
	Exc. Suspensión Electrónica Ajustable	↓	G55505	142223 ⁵³ 142749 ⁶⁵	↓	69723 ⁹	81517	49370 ³⁰
	Exc. Suspensión Electrónica Ajustable	↓	G55505	142223 ⁵³ 142749 ⁶⁵	↓	42517 49370 ³⁰

CIERA / CUTLASS CIERA READYMOUNTS

		Delantero	Trasero
85-96	Exc. Suspensión Electrónica Ajustable	G56908⁴⁰
84	Suspensión HD	G56908⁴⁰

7 Paquetes en pares; kit de mangueras de aire incluido

9 Vea Ref.D para los procedimientos de reemplazo de una Susp. Elect. Ajust. con un producto no ajust.

40 Strut ReadyMount. Ensamble Completo

65 El Kit de Montaje incluye: Asiento de Resorte Superior con Aislador. Es probable reutilizar algunas partes del E.O.

Texto en Negritas - Número de Parte Nuevo / Futuro



8 Paquetes en pares

30 Para Vehículos GM equipados con sistemas de nivelación de fábrica, vea Ref. A.

53 Montaje de Strut. Es probable reutilizar algunas partes del E.O.

98 Nota: El nivel de dificultad para instalar este producto es moderadamente alto. Por favor revise las instrucciones cuidadosamente antes de comenzar.

AMORTIGUADORES Y STRUTS

Año	Notas de Aplicación										
		Ultra	ProGuard\ Guardian	LTV\ Max Control	Protector de Strut\ Bases de Strut	HiJacker\ Soporte\ Hidráulico	Ultra	ProGuard\ Guardian	LTV\ Max Control	Protector de Strut\ Bases de Strut	HiJacker\ Soporte\ Hidráulico

OLDSMOBILE

OLDSMOBILE

CUSTOM CRUISER

77-92	Todos	⊕	69675 ⁵	81446	34073 ⁸	⊕	69604	81492	43060 ⁹ 49152 ³⁰
71-76	Todos	⊕	69675 ⁵	81446	34073 ⁸	⊕	69604	81492

CUTLASS / CUTLASS SUPREME

99	Todos	⊕	G55974	⊕	G56501	142532 ⁵³
98	Todos	⊕	⊕	142532 ⁵³
	Diseño Inicial c/ Struts Traseros c/ orificios en Montaje Inferior separados 3.2"	⊕	⊕	G55975	142532 ⁵³
	Segundo Diseño c/ Struts Traseros con orificios en Montaje Inferior separados 2.4"	⊕	⊕	G56501	142532 ⁵³
	Struts Traseros con orificios en Montaje Inferior separados a 2.4" y 3.2"	⊕	G55974	⊕	142532 ⁵³
97	Todos	⊕	G44459 ³⁶	142143 ⁵³	⊕	142532 ⁵³
	Diseño Inicial c/ Struts Traseros c/ orificios en Montaje Inferior separados 3.2"	⊕	G44459 ³⁶	142143 ⁵³	⊕	G55975	142532 ⁵³
	Exc. Struts Traseros con orificios en Montaje Inferior separados 3.2"	⊕	G44459 ³⁶	142143 ⁵³	⊕	G56708	142532 ⁵³
	3.1L 2BBL	⊕	G44459 ³⁶	142143 ⁵³	⊕	69723	142532 ⁵³
94-96	1.2L 2BBL	⊕	G44459 ³⁶	142143 ⁵³	⊕	69723 G56708
88-96	Todos	⊕	G44459 ³⁶	142143 ⁵³	⊕	G56708
	3.1L 2BBL	⊕	G44459 ³⁶	142143 ⁵³	⊕	69723 G56708
86-87	3.1L 2BBL	⊕	69600	81494	34051 ⁸	⊕	69723 69604	81492	43060 ⁹ 49334 ³⁰
79-87	Todos	⊕	69600	81494	34051 ⁸	⊕	69604	81492	43060 ⁹ 49334 ³⁰
78-79	Vista Cruiser	⊕	69600	81494	34051 ⁸	⊕	69604	81492	49334 ³⁰ 43060 ⁹
76-78	Todos	⊕	69600	81494	34051 ⁸	⊕	69604	81492	43060 ⁹
76-77	Coupe	⊕	69600	81494	34051 ⁸	⊕	69604	81492	49152 ³⁰ 43060 ⁹
	Sedan	⊕	69600	81494	34051 ⁸	⊕	69604	81492	49152 ³⁰ 43060 ⁹
	Wagon	⊕	69600	81494	34051 ⁸	⊕	69604	81492	49334 ³⁰ 43060 ⁹
73-75	Todos	⊕	69600	81494	34051 ⁸	⊕	69604	81492	43060 ⁹ 49152 ³⁰
71-72	Todos	⊕	69600	81494	34051 ⁸	⊕	69604	81492	43060 ⁹
68-72	Suspensión HD	⊕	69600	81494	34051 ⁸	⊕	69604	81492	43060 ⁹
72	Base, S	⊕	69600	81494	34051 ⁸	⊕	69604	81492	49152 ³⁰ 43060 ⁹
	Cruiser	⊕	69600	81494	34051 ⁸	⊕	69604	81492	49114 ⁷ 43060 ⁹
	Exc. Cruiser	⊕	69600	81494	34051 ⁸	⊕	69604	81492	43060 ⁹
71	Exc. Vista Cruiser	⊕	69600	81494	34051 ⁸	⊕	69604	81492	49152 ³⁰ 43060 ⁹
68-70	Todos	⊕	69600	81494	34051 ⁸	⊕	81492	43060 ⁹
	Exc. Vista Cruiser	⊕	69600	81494	34051 ⁸	⊕	81492	49152 ³⁰ 43060 ⁹

5 Use el kit 140719 para reemplazar partes del EO de montaje inferior cuando los pernos se rompan o los tornillos autoroscantes no se puedan utilizar más.

8 Paquetes en pares

36 Requiere una herramienta especial de instalación para struts.

7 Paquetes en pares; kit de mangueras de aire incluido

30 Para Vehículos GM equipados con sistemas de nivelación de fábrica, vea Ref. A.

53 Montaje de Strut. Es probable reutilizar algunas partes del E.O.

AMORTIGUADORES Y STRUTS

Año	Notas de Aplicación	Front					Rear				
		Ultra	ProGuard\ Guardian	LTV\ Max Control	Protector de Strut\ Bases de Strut	HiJacker\ Soporte\ Hidráulico	Ultra	ProGuard\ Guardian	LTV\ Max Control	Protector de Strut\ Bases de Strut	HiJacker\ Soporte\ Hidráulico

OLDSMOBILE

OLDSMOBILE

CUTLASS / CUTLASS SUPREME (cont)

66-67	Exc. Suspensión HD	69724	81514	43049 ⁸
	Base, Exc. Suspensión HD	49131 ³⁰
64-67	Suspensión HD Exc. Vista Cruiser	49152 ³⁰
	Base, Holiday	⊕	82138
67	Suspensión HD	81492	43060 ⁸
	Turnpike Cruiser	⊕	82110	49128 ⁷
64-66	Suspensión HD	69604	81492	43060 ⁸
64-65	Exc. Suspensión HD	69724	81514	43049 ⁸ 49131 ³⁰

CUTLASS / CUTLASS SUPREME READYMOUNTS

		Delantero		Trasero	
98-99	Todos	G56927 ⁴⁰		
97	Todos	G56927 ⁴⁰		G56727 ⁴²	
88-96	Todos		G56727 ⁴²	

CUTLASS CALAIS

88-91	Izquierdo	G56706	142762 ⁶⁵	⊕	69749	81530	141974 ⁵³	49371 ⁷
	Derecho	G56705	142762 ⁶⁵	⊕	69749	81530	141974 ⁵³	49371 ⁷

CUTLASS CLASSIC / CUTLASS CRUISER

87-94	Todos	142749 ⁶⁵	⊕
	Exc. Suspensión Electrónica Ajustable	G55514	142223 ⁵³ 142749 ⁶⁵	⊕	69723 ⁹	81517	141974 ⁵³	49370 ³⁰
	Exc. Suspensión Electrónica Ajustable	142749 ⁶⁵	⊕	42517
80-83	Todos	⊕	69600	81494	⊕	69604	81492	43060 ⁸ 49334 ³⁰

CUTLASS CLASSIC / CUTLASS CRUISER READYMOUNTS

		Delantero		Trasero	
87-94	Exc. Suspensión Electrónica Ajustable	G56908 ⁴⁰		

F85

68-72	Todos	⊕	69600	81494	⊕	69604	81492	43060 ⁸ 49152 ³⁰
64-67	Todos	⊕	82138	⊕
	Exc. Suspensión HD	⊕	82138	⊕	69724	81514	43049 ⁸ 49131 ³⁰
	Suspensión HD	⊕	82138	⊕	69604	81492	43060 ⁸ 49152 ³⁰

FIESTA

63	Todos	⊕	82079	⊕	82089
59-62	Todos	⊕	82079	⊕
58	Exc. Suspensión de Aire '58	⊕	82079	⊕
57	Todos	⊕	82079	⊕

7 Paquetes en pares; kit de mangueras de aire incluido

9 Vea Ref.D para los procedimientos de reemplazo de una Susp. Elect. Ajust. con un producto no ajust.

40 Strut ReadyMount. Ensamble Completo

53 Montaje de Strut. Es probable reutilizar algunas partes del E.O.

Texto en Negritas - Número de Parte Nuevo / Futuro

8 Paquetes en pares

30 Para Vehículos GM equipados con sistemas de nivelación de fábrica, vea Ref. A. 42 Strut ReadyMount, no incluye resortes por el diseño del vehículo.

65 El Kit de Montaje incluye: Asiento de Resorte Superior con Aislador. Es probable reutilizar algunas partes del E.O.

AMORTIGUADORES Y STRUTS

Año	Notas de Aplicación	Front					Rear				
		Ultra	ProGuard\ Guardian	LTV\ Max Control	Protector de Strut\ Bases de Strut	HiJacker\ Soporte\ Hidráulico	Ultra	ProGuard\ Guardian	LTV\ Max Control	Protector de Strut\ Bases de Strut	HiJacker\ Soporte\ Hidráulico

OLDSMOBILE FIRENZA

88	Izquierdo	G56706	I/O	69749	81530	141974 ⁵³	49371 ⁷
	Derecho	G56705	I/O	69749	81530	141974 ⁵³	49371 ⁷
87	Izquierdo	G56706	142762 ⁶⁵	I/O	69749	81530	141974 ⁵³	49371 ⁷
	Derecho	G56705	142762 ⁶⁵	I/O	69749	81530	141974 ⁵³	49371 ⁷
84-86	Todos	142762 ⁶⁵	I/O	141974 ⁵³
	Izquierdo Struts de EO no reconstruibles	G56706	142762 ⁶⁵	I/O	141974 ⁵³
	Derecho Struts de EO no reconstruibles	G56705	142762 ⁶⁵	I/O	141974 ⁵³
	Struts Reconstruibles de EO	G44451 ⁹⁸	142762 ⁶⁵	I/O	69749	81530	141974 ⁵³	49371 ⁷
82-83	Todos	142762 ⁶⁵	I/O	69749	81530	49371 ⁷

OLDSMOBILE

INTRIGUE

98-02	Todos	G55948	142524 ⁵⁸ 142525 ⁵³ 142526 ⁵⁴	I/O
	Exc. Modelos c/ Ruedas de 17" o 18"	G55948	142524 ⁵⁸ 142525 ⁵³ 142526 ⁵⁴	I/O	G55949
	Izquierdo	G55948	142524 ⁵⁸ 142525 ⁵³ 142526 ⁵⁴	I/O	143073 ⁵³
	Derecho	G55948	142524 ⁵⁸ 142525 ⁵³ 142526 ⁵⁴	I/O	143074 ⁵³

INTRIGUE READYMOUNTS

		Delantero	Trasero
98-02	Izquierdo	G57060 ⁴⁰	G56924 ⁴⁰
	Derecho	G57060 ⁴⁰	G56925 ⁴⁰

JETFIRE

63	Todos	I/O	82079	I/O	82089
62	Todos	I/O	82079	I/O

LSS

96-99	Todos	G56718 ⁹	142524 ⁵⁸ 142751 ⁶⁵	I/O	142132 ⁵³
	Air(RearSpringType)	G56718 ⁹	142524 ⁵⁸ 142751 ⁶⁵	I/O	G56903	142132 ⁵³
	Coil(RearSpringType) Reemplazo Tipo Convencional para Susp. Trasera Asistida por Aire	G56718 ⁹	142524 ⁵⁸ 142751 ⁶⁵	I/O	G56707 ⁹	142132 ⁵³

LSS READYMOUNTS

		Delantero	Trasero
96-99	Todos	G56909 ⁴
	Air(RearSpringType)	G56909 ⁴	G56906 ⁴³
	Coil(RearSpringType) Reemplazo Tipo Convencional para Susp. Trasera Asistida por Aire	G56909 ⁴	G56726 ⁴³

4 Número de futuro, las cantidades disponibles Q4 2016.

9 Vea Ref.D para los procedimientos de reemplazo de una Susp. Elect. Ajust. con un producto no ajust.

43 Strut ReadyMount, no incluye resortes por el diseño del vehículo. Consulte la Ref. D para el procedimiento de reemplazo en una Susp. Elec. Ajustable con un producto no ajustable

54 Kit con Montaje y Rodamiento. Es probable que reutilizar algunas partes del E.O.

65 El Kit de Montaje incluye: Asiento de Resorte Superior con Aislador. Es probable reutilizar algunas partes del E.O.

Texto en Negritas - Número de Parte Nuevo / Futuro

7 Paquetes en pares; kit de mangueras de aire incluido



40 Strut ReadyMount. Ensemble Completo

53 Montaje de Strut. Es probable reutilizar algunas partes del E.O.

58 El Kit de Montaje incluye: Rodamiento de Suspensión. Es probable reutilizar algunas partes del E.O.

98 Nota: El nivel de dificultad para instalar este producto es moderadamente alto. Por favor revise las instrucciones cuidadosamente antes de comenzar.

AMORTIGUADORES Y STRUTS

Año	Notas de Aplicación										
		Ultra	ProGuard\ Guardian	LTV\ Max Control	Protector de Strut\ Bases de Strut	HiJacker\ Soporte\ Hidráulico	Ultra	ProGuard\ Guardian	LTV\ Max Control	Protector de Strut\ Bases de Strut	HiJacker\ Soporte\ Hidráulico

OLDSMOBILE

OLDSMOBILE

STARFIRE (cont)

63-64	Todos	82079	82089
61-62	Todos	82079
57	Todos	82079

TORONADO

90-92	Todos	G56717 ⁹	142227 ⁵⁸ 142297 ⁵⁴	G56704 ⁹	142405 ⁵³
86-89	Todos	G56703	142298 ⁵⁴	G56704 ⁹	142405 ⁵³
79-85	Todos	69706	81445	49345 ³⁰
71-78	Todos	82010	69604	81492	43060 ⁸ 49152 ³⁰
67-70	Montado Verticalmente	82010	82034
66	Montado Verticalmente	82010	82040	49122 ⁷

TORONADO ESTABILIZADORES DE DIRECCIÓN

		Delantero		Trasero	
79-85	Todos	14020		
71-78	Todos	14010		
66	Todos	14010		

VISTA CRUISER

73-75	Todos	69600
68-72	Todos	69600	69606	49114 ⁷
	Montaje Superior de Espiga	69600	69606	81495	49114 ⁷
64-67	Todos	69606	49114 ⁷
	Montaje Superior de Espiga	69606	81495	49114 ⁷

OPEL

OPEL

1900

71-75	Todos	82614
-------	-------	-------	-------	-------	-------	-------	-------	-------	-------	-------	-------

KADETT

68-72	Todos	82123
-------	-------	-------	-------	-------	-------	-------	-------	-------	-------	-------	-------

MANTA

71-75	Todos	82614
-------	-------	-------	-------	-------	-------	-------	-------	-------	-------	-------	-------

OPEL

69-73	Todos	82039
-------	-------	-------	-------	-------	-------	-------	-------	-------	-------	-------	-------

PEUGEOT

PEUGEOT

206

00-09	Izquierdo	G56982	40025
	Derecho	G56983	40025

7 Paquetes en pares; kit de mangueras de aire incluido

9 Vea Ref.D para los procedimientos de reemplazo de una Susp. Elect. Ajust. con un producto no ajust.

53 Montaje de Strut. Es probable reutilizar algunas partes del E.O.



58 El Kit de Montaje incluye: Rodamiento de Suspensión. Es probable reutilizar algunas partes del E.O.

8 Paquetes en pares

30 Para Vehículos GM equipados con sistemas de nivelación de fábrica, vea Ref. A.









54 Kit con Montaje y Rodamiento. Es probable que reutilizar algunas partes del E.O.

AMORTIGUADORES Y STRUTS

Año	Notas de Aplicación										
		Ultra	ProGuard\ Guardian	LTV\ Max Control	Protector de Strut\ Bases de Strut	HiJacker\ Soporte\ Hidráulico	Ultra	ProGuard\ Guardian	LTV\ Max Control	Protector de Strut\ Bases de Strut	HiJacker\ Soporte\ Hidráulico





PEUGEOT

207





08-13	Compact Izquierdo		G52337		70072
	Compact Derecho		G52338		70072
09-11	Sedan Izquierdo		G56982		40025
	Sedan Derecho		G56983		40025

PEUGEOT



306

97-06	Derecho		56743		42955
	Izquierdo		56744		42955



307

03-10	Izquierdo		G52214		70012
	Derecho		G52215		70012







403

59-66	Todos			82125
-------	-------	---	------	------	------	------	------	---	------	-------	------	------	------





404

61-67	Todos			82125
-------	-------	---	------	------	------	------	------	---	------	-------	------	------	------





504 / 505 / 604

84-90	Sedan			69645
77-83	Todos			69645
76-79	Sedan			69645





GRAND RAID

07-12	Izquierdo		G52046		70009
	Derecho		G52047		70009

PARTNER



03-09	Izquierdo		G52046		70009
	Derecho		G52047		70009

AMORTIGUADORES Y STRUTS

Año	Notas de Aplicación										
			Ultra	ProGuard\ Guardian	LTV\ Max Control	Protector de Strut\ Bases de Strut	HiJacker\ Soporte\ Hidráulico		Ultra	ProGuard\ Guardian	LTV\ Max Control

PLYMOUTH



ACCLAIM

89-95	Todos		G55526	142567 142568 ⁶⁴ 142880 ⁶⁴ 142933 ⁶⁶ 142940 ⁶⁶		69632	81459	49369 ⁷
-------	-------	---	--------	------	------	--	------	---	-------	-------	------	------	--------------------





ACCLAIM READYMOUNTS

89-95	Exc. Sistema de Autonivelación NIVOMAT								Delantero	Trasero
									G56985 ⁴⁰

ARROW

76-80	Todos			81676
-------	-------	---	------	------	------	------	------	---	------	-------	------	------	------





ARROW PICKUP

79-82	Todos			70163
	Todos		G63950	61556 81714		G63907	61500 81147	77907	43048 ⁸ 49310 ⁷ 70163







ARROW PICKUP ESTABILIZADORES DE DIRECCIÓN

79-82	Todos								Delantero	Trasero
									6802SE ⁸⁴













BARRACUDA

70-74	Todos		82090		82131
64-69	Todos		82090		81469	49110 ⁷

BELVEDERE

62-70	Todos		82090		82131	43096 ⁸ 49106 ⁷
57-61	Todos		82072		81469	49110 ⁷
53-56	Todos			81469	49110 ⁷



BREEZE

99-00	Todos			G51268	143328 ⁶³
	Exc. Código de Fabricación de Carrocería JA		G51267		G51268	143328 ⁶³
97-98	Todos			G51078
	JA(Cdigo plataforma del fabricante)		G51796		G51078
96	Todos		G55818		G51078
	JA(Cdigo plataforma del fabricante)		G51796		G51078



BREEZE READYMOUNTS

99-00	Todos								Delantero	Trasero
									G57025 ⁴⁰

CAMBRIDGE

51-53	Todos			81469	49110 ⁷
-------	-------	---	------	------	------	------	------	---	------	-------	------	------	--------------------

CARAVELLE

89	Todos		81406	
----	-------	---	------	-------	------	------	------	---	------	------	------	------	------

7 Paquetes en pares; kit de mangueras de aire incluido

40 Strut ReadyMount. Ensamble Completo

56 El Kit de Montaje incluye: Montaje, Parachoques y Retenedores. Es probable reutilizar algunas partes del E.O.

64 El Kit de Montaje incluye: Aislador de Goma del Asiento de Resorte. Es probable reutilizar algunas partes del E.O.

84 Amortiguador de repuesto para los vehículos con el kit de montaje aftermarket GRC

Texto en Negritas - Número de Parte Nuevo / Futuro



8 Paquetes en pares

54 Kit con Montaje y Rodamiento. Es probable que reutilizar algunas partes del E.O.

63 El Kit de Montaje incluye: Aislador Parachoques. Es probable reutilizar algunas partes del E.O.

66 Asiento de Resorte Superior con Espaciador. Es probable reutilizar algunas partes del E.O.

AMORTIGUADORES Y STRUTS

Año	Notas de Aplicación	From 					Rear 				
		Ultra	ProGuard\ Guardian	LTV\ Max Control	Protector de Strut\ Bases de Strut	HiJacker\ Soporte\ Hidráulico	Ultra	ProGuard\ Guardian	LTV\ Max Control	Protector de Strut\ Bases de Strut	HiJacker\ Soporte\ Hidráulico

PLYMOUTH

CARAVELLE (cont)

PLYMOUTH

89	RWD	69704	81406	69703	81338	49346 ⁷
88	Todos	G55526	81406	142567
	FWD	G55526	81406	142567 ⁶⁴	69632	81459	49369 ⁷
	RWD	69704	81406	142567 ⁶⁴	69703	81338	49346 ⁷
87	Todos	G55526	81406	142567 ⁶⁴	69632	81459	49369 ⁷
	FWD	G55526	81406	142567 ⁶⁴	69632	81459	49369 ⁷
	RWD	69704	81406	142567 ⁶⁴	69703	81338	49346 ⁷
86	Todos	G55526	81406	142567 ⁶⁴	69632	81459	49369 ⁷
	Fab. desde 02/Enero/86	G55526	81406	142940 ⁶⁶	69632	81459	49369 ⁷
85	Todos	G55511	81406	69632	81459	49369 ⁷
84	Todos	G55511	69632	81459	49369 ⁷
83	Todos	G55507	69632	81459	49369 ⁷
78-81	RWD	69704	81406	69703	81338	49346 ⁷

CHAMP

79-82	Todos	69689	81464
-------	-------	------	------	------	------	------	-------	-------	------	------	------

COLT

93-94	Sedan	G55911	142329 ⁵³	69689	81464	142419 ⁵³
92-94	Todos	142419 ⁵³
	Wagon	G55605	69462	142419 ⁵³
92	FWD, Hatchback	81464	142419 ⁵³
	Hatchback	69689	142419 ⁵³
	Sedan	69689	81464	142419 ⁵³
90-91	FWD, Hatchback	G51249	142419 ⁵³
	Hatchback	G55592	69689	142419 ⁵³
89-91	Todos	69689	142419 ⁵³
	Vista, 4WD	69689	81739	142419 ⁵³
	Vista, FWD, Wagon	69689	81464	142419 ⁵³
89-90	DL, Wagon	G55561	69689	142419 ⁵³

7 Paquetes en pares; kit de mangueras de aire incluido

54 Kit con Montaje y Rodamiento. Es probable que reutilizar algunas partes del E.O.



64 El Kit de Montaje incluye: Aislador de Goma del Asiento de Resorte. Es probable reutilizar algunas partes del E.O.

53 Montaje de Strut. Es probable reutilizar algunas partes del E.O.

56 El Kit de Montaje incluye: Montaje, Parachoques y Retenedores. Es probable reutilizar algunas partes del E.O.

66 Asiento de Resorte Superior con Espaciador. Es probable reutilizar algunas partes del E.O.

AMORTIGUADORES Y STRUTS

Año	Notas de Aplicación										
		Ultra	ProGuard\ Guardian	LTV\ Max Control	Protector de Strut\ Bases de Strut	HiJacker\ Soporte\ Hidráulico	Ultra	ProGuard\ Guardian	LTV\ Max Control	Protector de Strut\ Bases de Strut	HiJacker\ Soporte\ Hidráulico

PLYMOUTH

COLT (cont)

90	Exc. Modelo Vista	143060	69689	142419 ⁹³
89	Hatchback	G55592	G51249 69689	142419 ⁹³
85-88	Todos	69689
	Vista, FWD, Wagon	69689	81464
88	DL, Wagon	G55561	69689
87	Hatchback	G55561	69689
	Sedan	G55561	69689
84	Hatchback	69689
	Vista, FWD, Wagon	81464
81-83	Hatchback	69689	81464
80	Todos	82156	43048 ⁸ 49151 ⁷
	Hatchback	69689	81464 82156	43048 ⁸ 49151 ⁷
76-79	Todos	81676 82156	43048 ⁸ 49151 ⁷

CONCORD

51-52	Todos	81469	49110 ⁷
-------	-------	-------	-------	-------	-------	-------	-------	-------	-------	-------	--------------------

CRANBROOK

51-53	Todos	81469	49110 ⁷
-------	-------	-------	-------	-------	-------	-------	-------	-------	-------	-------	--------------------

CUSTOM

58-61	Todos	82072	81469	49110 ⁷
-------	-------	-------	-------	-------	-------	-------	-------	-------	-------	-------	--------------------

DUSTER

70-76	Todos	82090	81469	49110 ⁷
-------	-------	-------	-------	-------	-------	-------	-------	-------	-------	-------	--------------------

EXPO

87-89	Todos	G55507	G51047	142173 ⁹³
-------	-------	--------	-------	-------	-------	-------	--------	-------	-------	----------------------	-------

FLEET SPECIAL

62-63	Todos	82090	82131	49106 ⁷
60-61	Todos	82072	81469	49110 ⁷

FURY

77-78	Todos	81153	69703	81338
	Exc. Paquete Policía	81153	69703	81338	43138 ⁸
	Paquete Policía	81153	69703	82131 81338	43096 ⁸ 49106 ⁷
75-76	Todos	81153	82131	43096 ⁸ 49106 ⁷
74	Todos	69704	82131	43096 ⁸ 49106 ⁷
73	Todos	82011	81091
	Exc. Wagon	82011	81091
	Exc. Wagon	82011	81091	49149 ⁷

7 Paquetes en pares; kit de mangueras de aire incluido

8 Paquetes en pares

53 Montaje de Strut. Es probable reutilizar algunas partes del E.O.

AMORTIGUADORES Y STRUTS

Año	Notas de Aplicación	Front					Rear				
		Ultra	ProGuard\ Guardian	LTV\ Max Control	Protector de Strut\ Bases de Strut	HiJacker\ Soporte\ Hidráulico	Ultra	ProGuard\ Guardian	LTV\ Max Control	Protector de Strut\ Bases de Strut	HiJacker\ Soporte\ Hidráulico

PLYMOUTH

FURY (cont)

73	Wagon	○	82011	○	82131 81091	49106 ⁷ 43096 ⁸
70-72	Todos	○	82011	○	81091	49149 ⁷
65-69	Todos	○	82011	○	82131	43096 ⁸ 49106 ⁷
62-64	Todos	○	82090	○	82131	49106 ⁷
57-61	Todos	○	82072	○	81469	49110 ⁷
56	Todos	○	○	81469	49110 ⁷

PLYMOUTH

GRAN FURY

82-89	Todos	○	69704	81406	○	69703	81338	43138 ⁸ 49346 ⁷
80-81	Todos	○	69704	81153	○	69703	81338	43138 ⁸
74-77	Todos	○	69704	81406	○	82131	43096 ⁸ 49106 ⁷
73	Todos	○	82011	○
	Hardtop	○	82011	○	81091	43067 ⁸ 49149 ⁷
	Wagon	○	82011	○	82131	49106 ⁷ 43096 ⁸
72	Todos	○	82011	○	81091	49149 ⁷

GRAND CARAVAN

95-00	Todos	○	○	43186
-------	-------	---	-------	-------	-------	-------	-------	---	-------	-------	-------	-------	-------

GTX

67	Todos	○	82090	○	82131	43096 ⁸ 49106 ⁷
----	-------	---	-------	-------	-------	-------	-------	---	-------	-------	-------	-------	--

HORIZON

90	Todos	○	G55594	○	G51047	142173 ⁵³
81-89	Todos	○	G55507	○	G51047	142173 ⁵³
78-80	Todos	○	G55507	○	142173 ⁵³

LASER

92-94	AWD	○	G55605	142219 ⁵³	○	G51046	142419 ⁵³
90-94	Todos	○	142219 ⁵³	○	142419 ⁵³
	FWD	○	G55587	142219 ⁵³	○	G51184	142419 ⁵³

NEON

00-01	Izquierdo	○	G55892	142932 ⁵⁵	○	G55894	143256 ⁵³
	Derecho	○	G55892	142932 ⁵⁵	○	G55893	143256 ⁵³
95-99	Todos	○	G55679	142840 ⁵⁴	○	G55680	142393 ⁵³

NEON READYMOUNTS

		Delantero	Trasero
00-01	Izquierdo	G56975 ⁴⁰	G56973 ⁴⁰
	Derecho	G56975 ⁴⁰	G56974 ⁴⁰

7 Paquetes en pares; kit de mangueras de aire incluido

40 Strut ReadyMount. Ensamble Completo

54 Kit con Montaje y Rodamiento. Es probable que reutilizar algunas partes del E.O.





8 Paquetes en pares

53 Montaje de Strut. Es probable reutilizar algunas partes del E.O.

55 El Kit de Montaje incluye: Montaje, Asiento de Resorte, Rodamiento y Aislador. Es probable reutilizar algunas partes del E.O.

Texto en Negritas - Número de Parte Nuevo / Futuro

AMORTIGUADORES Y STRUTS

Año	Notas de Aplicación										
			Ultra	ProGuard\ Guardian	LTV\ Max Control	Protector de Strut\ Bases de Strut	HiJacker\ Soporte\ Hidráulico		Ultra	ProGuard\ Guardian	LTV\ Max Control





PLYMOUTH

PLYMOUTH







NEON READYMOUNTS (cont)

		Delantero				Trasero
95-99	Todos	G56966 ⁴⁰				G56967 ⁴⁰







PLAZA

57-58	Todos		82072		81469	49110 ⁷
54-56	Todos			81469	49110 ⁷







RELIANT

86-89	Todos		G55526	142567 142568 ⁵⁴ 142880 ⁵⁴ 142933 ⁵⁶ 142940 ⁵⁶		69632	81459	49369 ⁷
84-85	Todos		G55511		69632	81459	49369 ⁷
81-83	Todos		G55507		69632	81459	49369 ⁷







ROADRUNNER

73-75	Todos		81153		82131	43096 ⁸ 49106 ⁷
71-72	Todos		82090		82131	49106 ⁷
68-70	Todos		82090		82131	43096 ⁸ 49106 ⁷



SATELLITE

73-74	Todos		81153		82131	43096 ⁸ 49106 ⁷
71-72	Todos		82090		82131	49106 ⁷
65-70	Todos		82090		82131	43096 ⁸ 49106 ⁷



SAVOY

62-64	Todos		82090		82131	49106 ⁷
57-61	Todos		82072		81469	49110 ⁷
53-56	Todos			81469	49110 ⁷





SCAMP

71-76	Todos		82090		81469	49110 ⁷
-------	-------	---	------	-------	------	------	------	---	------	-------	------	------	--------------------



SPORT WAGON

60-61	Todos		82072		81469	49110 ⁷
-------	-------	---	------	-------	------	------	------	---	------	-------	------	------	--------------------

SUBURBAN

57-61	Todos		82072		81469	49110 ⁷
51-56	Todos			81469	49110 ⁷

SUNDANCE

87-94	Todos		G55526	142567 142568 ⁵⁴ 142880 ⁵⁴ 142933 ⁵⁶ 142940 ⁵⁶		69632	81459	49369 ⁷
-------	-------	---	--------	------	------	--	------	---	-------	-------	------	------	--------------------

SUNDANCE READYMOUNTS

		Delantero				Trasero
89-94	Exc. Sistema de Autonivelación NIVOMAT	G56985 ⁴⁰			

7 Paquetes en pares; kit de mangueras de aire incluido

40 Strut ReadyMount. Ensemble Completo

56 El Kit de Montaje incluye: Montaje, Parachoques y Retenedores. Es probable reutilizar algunas partes del E.O.

66 Asiento de Resorte Superior con Espaciador. Es probable reutilizar algunas partes del E.O.

Texto en Negritas - Número de Parte Nuevo / Futuro

8 Paquetes en pares

54 Kit con Montaje y Rodamiento. Es probable que reutilizar algunas partes del E.O.

64 El Kit de Montaje incluye: Aislador de Goma del Asiento de Resorte. Es probable reutilizar algunas partes del E.O.

AMORTIGUADORES Y STRUTS

Año	Notas de Aplicación	From					Rear				
		Ultra	ProGuard\ Guardian	LTV\ Max Control	Protector de Strut\ Bases de Strut	HiJacker\ Soporte\ Hidráulico	Ultra	ProGuard\ Guardian	LTV\ Max Control	Protector de Strut\ Bases de Strut	HiJacker\ Soporte\ Hidráulico

PLYMOUTH

SUPERBIRD

PLYMOUTH

70	Todos	○	82090	○	82131	43096 ⁸ 49106 ⁷
----	-------	---	-------	-------	-------	-------	-------	---	-------	-------	-------	-------	-------	--

TRAILDUSTER

81	Todos	○	77359 ³⁵	34052 ⁸	○	43067 ⁸ 49149 ⁷
	4WD	○	G63183	61632 81825	58183 77359 ³⁵	34052 ⁸	○	G63389	61633 81342	58389 77389	43067 ⁸ 49149 ⁷
	4WD	○	77359 ³⁵	70175 34052 ⁸	○	43067 ⁸ 49149 ⁷
	RWD	○	G63359 ³⁵	61523 ³⁵ 81096 ³⁵	58359 ³⁵ 77359 ³⁵	34052 ⁸	○	G63353	61526 81091	58353	43067 ⁸ 49149 ⁷
76-80	Todos	○	○	43067 ⁸ 49149 ⁷
	4WD	○	G63183	61632 81825	58183	○	G63389	61633 81342	58389 77389	43067 ⁸ 49149 ⁷
	4WD	○	70175	○	43067 ⁸ 49149 ⁷
75-80	RWD	○	G63359 ³⁵	61523 ³⁵ 81096 ³⁵	58359 ³⁵ 77359 ³⁵	34052 ⁸	○	G63353	61526 81091	58353	43067 ⁸ 49149 ⁷
75	Todos	○	○	G63353	43067 ⁸ 49149 ⁷
	4WD	○	G63183	61632 81825	58183	○	G63353	43067 ⁸ 49149 ⁷
	4WD	○	70175	○	G63353	43067 ⁸ 49149 ⁷
74	Todos	○	58183	○	G63353	81091	58353	43067 ⁸ 49149 ⁷
	4WD	○	G63183	61632 81825	58183	○	G63353	81091	58353	43067 ⁸ 49149 ⁷
	4WD	○	58183	70175	○	G63353	81091	58353	43067 ⁸ 49149 ⁷
	RWD	○	58183	○	G63353	61526 81091	58353	43067 ⁸ 49149 ⁷

TRAILDUSTER ESTABILIZADORES DE DIRECCIÓN

		Delantero	Trasero
75-81	4WD, Estabilizador de Dirección Sistema Sencillo	6803SE ⁸⁴
74-81	Estabilizador de Dirección Sistema Dual; Exc. Servofreno montado del lado del Eje del Conductor	6802SE ⁸⁴
74	Estabilizador de Dirección Sistema Sencillo	6803SE ⁸⁴

TURISMO

85	Todos	○	G55507	○	G51047	142173 ⁵³
83	Todos	○	G55507	○	G51047	142173 ⁵³

VALIANT

81	3.7L 6Cyl (225) RWD; 4BBL	○	69704	81406	○	81469
60-76	Todos	○	82090	○	81469	49110 ⁷

VALIANT DUSTER

74-76	3.7L 6Cyl (225) RWD; 4BBL	○	82090	○	81469
-------	---------------------------	---	-------	-------	-------	-------	-------	---	-------	-------	-------	-------	-------

VALIANT SUPER BEE

78-79	5.9L 8Cyl (360) Van; 4BBL	○	69704	81406	○	81469
77	5.9L 8Cyl (360) Turbocharged; SOHC	○	69704	81406	○	81469
74-76	5.9L 8Cyl (360) Turbocharged; SFI	○	82090	○
76	5.9L 8Cyl (360) Turbocharged; SOHC	○	○	81469

7 Paquetes en pares; kit de mangueras de aire incluido



35 Es necesaria abertura en brazo de control para instalar el producto fabricado antes de agosto 1988.

84 Amortiguador de repuesto para los vehiculos con el kit de montaje aftermarket GRC

8 Paquetes en pares

53 Montaje de Strut. Es probable reutilizar algunas partes del E.O.







AMORTIGUADORES Y STRUTS

Año	Notas de Aplicación	Front					Rear				
			Ultra	ProGuard/ Guardian	LTV/ Max Control	Protector de Strut/ Bases de Strut	HiJacker/ Soporte/ Hidráulico		Ultra	ProGuard/ Guardian	LTV/ Max Control



PLYMOUTH

PLYMOUTH



VALIANT SUPER BEE (cont)

73-75	5.2L 8Cyl (318) MFI		82090		81469
72	5.2L 8Cyl (318) MFI		82090	
69-71	5.2L 8Cyl (318) MFI		82090		81469







VAN 1/2 TON, PB SERIES

74-83	Todos		G63359 ³⁵	61523 ³⁵ 81096 ³⁵	58359 ³⁵ 77359 ³⁵	34052 ⁸		G63413	61522 ⁶ 81496	58413 77413	43085 ⁸ 49212 ⁷
-------	-------	---	----------------------	--	--	-------	--------------------	---	--------	-----------------------------	----------------	-------	--



VAN 3/4 TON, PB SERIES

74-83	Todos		G63359 ³⁵	61523 ³⁵ 81096 ³⁵	58359 ³⁵ 77359 ³⁵	34052 ⁸		G63413	61522 ⁶ 81496	58413 77413	43085 ⁸ 49212 ⁷
-------	-------	---	----------------------	--	--	-------	--------------------	---	--------	-----------------------------	----------------	-------	--







VAN 1 TON, PB SERIES

74-83	Todos			G63413	61522 ⁶ 81496	58413 77413	43085 ⁸ 49212 ⁷
	Con Eje Delantero 4000#		G63360 ³⁵	61650 81834	58360		G63413	61522 ⁶ 81496	58413 77413	43085 ⁸ 49212 ⁷
	Exc. Eje Delantero 4000#		G63359 ³⁵	61523 ³⁵ 81096 ³⁵	58359 ³⁵ 77359 ³⁵	34052 ⁸		G63413	61522 ⁶ 81496	58413 77413	43085 ⁸ 49212 ⁷















VIP

67	Todos		82011		82131	43096 ⁸ 49106 ⁷
----	-------	---	-------	-------	-------	-------	-------	---	-------	-------	-------	-------	--











VOLARE

81-82	3.7L 6Cyl (225) RWD; 4BBL			81338
76-80	Todos		69704	81406		69703	81338	43138 ⁸ 49346 ⁷
76	3.7L 6Cyl (225) RWD; 4BBL		69704	81406		69703	81338	43138 ⁸ 49346 ⁷

VOLARE K

86-88	Todos		G55526	
	2.2L 2BBL		G55526		42459
	2.2L 4Cyl (135) 2BBL		G55526	55526		69632	81459
84-85	Todos		G55511	
	2.2L 2BBL		G55511		42459
	2.2L 4Cyl (135) 2BBL		G55511		69632	81459
82-83	2.2L 4Cyl (135) 2BBL			81459

VOYAGER / GRAND VOYAGER

96-00	Todos		G55697		61605 ³⁴ 81878	43186
	Exc. Opción de Autonivelación Nivomat		142753 ⁶ 142841 ³⁴		43186
	Exc. Sistema de Autonivelación NIVOMAT			G63690 ¹⁰	43186
	Non-ABS			49236 ⁷ 43186
95-00	Todos			43186

6 Se recomienda que cuando se reemplacen amortiguadores "quad", los 4 sean de la misma serie.

8 Paquetes en pares

34 Si el resorte toca el amortiguador, gire el resorte 180°.



54 Kit con Montaje y Rodamiento. Es probable que reutilizar algunas partes del E.O.

7 Paquetes en pares; kit de mangueras de aire incluido

10 Los amortiguadores NIVOMAT son para aplicación trasera únicamente. Si los resortes tocan los amortiguadores, gírelos 180°.

35 Es necesaria abertura en brazo de control para instalar el producto fabricado antes de agosto 1988.













AMORTIGUADORES Y STRUTS

Año	Notas de Aplicación	From 					Rear 				
		Ultra	ProGuard\ Guardian	LTV\ Max Control	Protector de Strut\ Bases de Strut	HiJacker\ Soporte\ Hidráulico	Ultra	ProGuard\ Guardian	LTV\ Max Control	Protector de Strut\ Bases de Strut	HiJacker\ Soporte\ Hidráulico

PLYMOUTH

PLYMOUTH

VOYAGER / GRAND VOYAGER (cont)

95	Todos		G55525	142567 142568 ⁶⁴ 142880 ⁵⁴ 142933 ⁵⁶		G63426	61538 81529	43186
87-94	Todos		G55525	142567 142568 ⁶⁴ 142880 ⁵⁴ 142933 ⁵⁶		G63426	61538 81529
86	Todos		142567 142568 ⁶⁴ 142880 ⁵⁴ 142933 ⁵⁶		G63426	61538 81529
	Fab. desde 1/86		G55525	142567 142568 ⁶⁴ 142880 ⁵⁴ 142933 ⁵⁶		G63426	61538 81529
	Fab. hasta 2/86		G55509	142567 142568 ⁶⁴ 142880 ⁵⁴ 142933 ⁵⁶		G63426	61538 81529
84-85	Todos		G55509		G63426	61538 81529

























VOYAGER / GRAND VOYAGER READYMOUNTS

		Delantero	Trasero
96-00	Todos	G56910⁶⁰
96	Exc. Sistema de Autonivelación NIVOMAT	G56910⁶⁰
87-95	Todos	G56907⁶⁰
86	Fabricado desde Ene/86	G56907⁶⁰

PONTIAC

PONTIAC

6000

91	FWD		142223 ⁵³ 142749 ⁶⁵		69723	81517	141974 ⁵³	49370 ³⁰
	FWD			42517
	FWD, Suspensión HD		G55514	
89-90	Todos		142223 ⁵³ 142749 ⁶⁵	
	Suspensión HD		G55514	142223 ⁵³ 142749 ⁶⁵	
	FWD		142223 ⁵³ 142749 ⁶⁵		69723	81517	141974 ⁵³	49370 ³⁰
	FWD		142223 ⁵³ 142749 ⁶⁵		42517
84-88	Todos		142223 ⁵³ 142749 ⁶⁵		69723	81517	141974 ⁵³	49370 ³⁰ 42517
	Suspensión HD		G55514		42517
82-88	Todos			42517
84	Exc. Suspensión HD		G55505		42517
82-83	Todos		G55505	142223 ⁵³		69723	81517	49370 ³⁰ 42517

6000 READYMOUNTS

		Delantero	Trasero
91	FWD	G56908⁶⁰

30 Para Vehículos GM equipados con sistemas de nivelación de fábrica, vea Ref. A.

53 Montaje de Strut. Es probable reutilizar algunas partes del E.O.

56 El Kit de Montaje incluye: Montaje, Parachoques y Retenedores. Es probable reutilizar algunas partes del E.O.

65 El Kit de Montaje incluye: Asiento de Resorte Superior con Aislador. Es probable reutilizar algunas partes del E.O.



40 Strut ReadyMount. Ensamble Completo

54 Kit con Montaje y Rodamiento. Es probable que reutilizar algunas partes del E.O.

64 El Kit de Montaje incluye: Aislador de Goma del Asiento de Resorte. Es probable reutilizar algunas partes del E.O.

Texto en Negritas - Número de Parte Nuevo / Futuro

AMORTIGUADORES Y STRUTS

Año	Notas de Aplicación	Front					Rear				
			Ultra	ProGuard\ Guardian	LTV\ Max Control	Protector de Strut\ Bases de Strut	HiJacker\ Soporte\ Hidráulico		Ultra	ProGuard\ Guardian	LTV\ Max Control



PONTIAC

PONTIAC



6000 READYMOUNTS (cont)

		Delantero	Trasero
84-90	Todos	G56908 ⁴⁰







ACADIAN

76-87	Todos		81322		81340
-------	-------	---	------	-------	------	------	------	---	------	-------	------	------	------

































ASTRE

75-77	Todos		82129		81438
-------	-------	---	------	-------	------	------	------	---	------	-------	------	------	------

AZTEK

01-05	Todos		G55834	142526 ⁵⁴	
	AWD		G55834	142526 ⁵⁴		G63868	61777
	FWD		G55834	142526 ⁵⁴		G63869

BONNEVILLE

05	Todos		G56509	142640 ⁵⁴		142647 ⁵³	49228 ³⁰	
00-04	Todos		G56509	142640 ⁵⁴		142647 ⁵³	
	Con Entradas de Aire de EO		G56509	142640 ⁵⁴		142647 ⁵³	49255	
	Debe usarse con el kit de mangueras incluido		G56509	142640 ⁵⁴		142647 ⁵³	49228 ³⁰	
98-99	Air(RearSpringType) Manejo con Comando Computarizado (CCR)		142226 ⁵⁴ 142751 ⁵⁵		142132 ⁵³	
97-99	Todos		142751 ⁵⁵		142132 ⁵³	
	Exc. Manejo con Comando Computarizado (CCR)		G56718 ⁹	142751 ⁵⁵		142132 ⁵³	
	Air(RearSpringType) Sistema de Autonivelación NIVOMAT de EO opcional Exc. Suspensión Elect. Ajustable		142751 ⁵⁵		G56903	142132 ⁵³
	Coil(RearSpringType) Exc. Suspensión Electrónica Ajustable		142751 ⁵⁵		G56707 ⁹	142132 ⁵³
94-96	Todos		142227 ⁵⁸ 142751 ⁵⁵		142132 ⁵³	
	Exc. Manejo con Comando Computarizado (CCR)		G56718 ⁹	142227 ⁵⁸ 142751 ⁵⁵		142132 ⁵³	
	Manejo con Comando Computarizado (CCR)		142226 ⁵⁴ 142227 ⁵⁸ 142751 ⁵⁵		142132 ⁵³	
	Air(RearSpringType) Sistema de Autonivelación NIVOMAT de EO opcional Exc. Suspensión Elect. Ajustable		142227 ⁵⁸ 142751 ⁵⁵		G56903	142132 ⁵³
	Coil(RearSpringType) Exc. Suspensión Electrónica Ajustable		142227 ⁵⁸ 142751 ⁵⁵		G56707 ⁹	142132 ⁵³
91-93	Todos		G56718 ⁹	142226 ⁵⁴ 142227 ⁵⁸ 142751 ⁵⁵		142132 ⁵³	
	Air(RearSpringType) Sistema de Autonivelación NIVOMAT de EO opcional Exc. Suspensión Elect. Ajustable		G56718 ⁹	142226 ⁵⁴ 142227 ⁵⁸ 142751 ⁵⁵		G56903	142132 ⁵³	

9 Vea Ref.D para los procedimientos de reemplazo de una Susp. Elect. Ajust. con un producto no ajust.

40 Strut ReadyMount. Ensamble Completo

54 Kit con Montaje y Rodamiento. Es probable que reutilizar algunas partes del E.O.

65 El Kit de Montaje incluye: Asiento de Resorte Superior con Aislador. Es probable reutilizar algunas partes del E.O.

Texto en Negritas - Número de Parte Nuevo / Futuro

30 Para Vehículos GM equipados con sistemas de nivelación de fábrica, vea Ref. A.

53 Montaje de Strut. Es probable reutilizar algunas partes del E.O.

58 El Kit de Montaje incluye: Rodamiento de Suspensión. Es probable reutilizar algunas partes del E.O.

AMORTIGUADORES Y STRUTS

Año	Notas de Aplicación	Front					Rear				
		Ultra	ProGuard\ Guardian	LTV\ Max Control	Protector de Strut\ Bases de Strut	HiJacker\ Soporte\ Hidráulico	Ultra	ProGuard\ Guardian	LTV\ Max Control	Protector de Strut\ Bases de Strut	HiJacker\ Soporte\ Hidráulico

PONTIAC

PONTIAC

BONNEVILLE (cont)

91-93	Coil(RearSpringType) Exc. Suspensión Electrónica Ajustable	G56718 ⁹	142226 ⁵⁴ 142227 ⁵⁸ 142751 ⁶⁵	G56707 ⁹	142132 ⁵³
90	Todos	142227 ⁵⁸ 142751 ⁶⁵	142132 ⁵³
	Strut Delantero de Diseño Inicial c/ Resorte de Seguridad	G56701	142227 ⁵⁸ 142751 ⁶⁵	142132 ⁵³
	Strut Delantero de Segundo Diseño sin Resorte de Seguridad	G56718 ⁹	142226 ⁵⁴ 142227 ⁵⁸ 142751 ⁶⁵	142132 ⁵³
	Air(RearSpringType) Sistema de Autonivelación NIVOMAT de EO opcional	142227 ⁵⁸ 142751 ⁶⁵	G56903	142132 ⁵³
	Coil(RearSpringType)	142227 ⁵⁸ 142751 ⁶⁵	G56707 ⁹	142132 ⁵³
88-89	Air(RearSpringType) Sistema de Autonivelación NIVOMAT de EO opcional	142227 ⁵⁸ 142752 ⁶⁵	G56903	142132 ⁵³
87-89	Todos	142227 ⁵⁸ 142752 ⁶⁵	142132 ⁵³
	Strut Delantero de Diseño Inicial c/ Resorte de Seguridad	G56701	142227 ⁵⁸ 142752 ⁶⁵	142132 ⁵³
	Coil(RearSpringType)	142227 ⁵⁸ 142752 ⁶⁵	G56707 ⁹	142132 ⁵³
87	Sistema de Autonivelación NIVOMAT de EO opcional	142227 ⁵⁸ 142752 ⁶⁵	G56903	142132 ⁵³
82-86	Todos	69600	81494	34051 ⁸	69604	81492	43060 ⁸ 49334 ³⁰
71-81	Todos	69675 ⁵	81446	34073 ⁸	69724	81514	43049 ⁸ 49131 ³⁰
65-70	Todos	82110	69724	81514	43049 ⁸ 49128 ³⁰
63-64	Todos	82099	69724	81514	43049 ⁸ 49128 ³⁰
61-62	Todos	82099
58-60	Todos	82099	82156
	Exc. Wagon	82099	81318 82156
57	Todos	82026	82156
	Exc. Wagon	82026	81318 82156

BONNEVILLE READYMOUNTS

		Delantero	Trasero
00-05	Exc. Suspensión Electrónica Ajustable	G57051 ⁴⁰
94-99	Air(RearSpringType) Manejo con Comando Computarizado (CCR)	G56909 ⁴
	Air(RearSpringType) Sistema de Autonivelación NIVOMAT de EO opcional Exc. Suspensión Elect. Ajustable	G56906 ⁴³
	Coil(RearSpringType) Exc. Suspensión Electrónica Ajustable	G56726 ⁴³
91-93	Todos	G56909 ⁴
	Air(RearSpringType) Sistema de Autonivelación NIVOMAT de EO opcional Exc. Suspensión Elect. Ajustable	G56909 ⁴	G56906 ⁴³
	Coil(RearSpringType) Exc. Suspensión Electrónica Ajustable	G56909 ⁴	G56726 ⁴³
88-90	Air(RearSpringType) Sistema de Autonivelación NIVOMAT de EO opcional	G56906 ⁴³
87-90	Strut Delantero de Diseño Inicial c/ Resorte de Seguridad	G56914 ⁴⁰
	Coil(RearSpringType)	G56726 ⁴³

4 Número de futuro, las cantidades disponibles Q4 2016.

8 Paquetes en pares

30 Para Vehículos GM equipados con sistemas de nivelación de fábrica, vea Ref. A.

43 Strut ReadyMount, no incluye resortes por el diseño del vehículo. Consulte la Ref. D para el procedimiento de reemplazo en una Susp. Elec. Ajustable con un producto no ajustable

54 Kit con Montaje y Rodamiento. Es probable que reutilizar algunas partes del E.O.

65 El Kit de Montaje incluye: Asiento de Resorte Superior con Aislador. Es probable reutilizar algunas partes del E.O.

Texto en Negritas - Número de Parte Nuevo / Futuro

5 Use el kit 140719 para reemplazar partes del EO de montaje inferior cuando los pernos se rompan o los tornillos autoroscantes no se puedan utilizar más.





9 Vea Ref.D para los procedimientos de reemplazo de una Susp. Elect. Ajust. con un producto no ajust.

40 Strut ReadyMount. Ensemble Completo

53 Montaje de Strut. Es probable reutilizar algunas partes del E.O.

58 El Kit de Montaje incluye: Rodamiento de Suspensión. Es probable reutilizar algunas partes del E.O.

AMORTIGUADORES Y STRUTS

Año	Notas de Aplicación										
			Ultra	ProGuard\ Guardian	LTV\ Max Control	Protector de Strut\ Bases de Strut	HiJacker\ Soporte\ Hidráulico		Ultra	ProGuard\ Guardian	LTV\ Max Control





















PONTIAC

PONTIAC









BONNEVILLE READYMOUNTS (cont)

		Delantero	Trasero
90	Strut Delantero de Diseño Tardío sin Resorte de Seguridad	G56909 ⁴
87	Sistema de Autonivelación NIVOMAT de EO opcional	G56906 ³



CATALINA

77-81	Wagon		69675 ⁵	81446	34073 ⁸		69604	81492	49152 ³⁰
71-81	Todos		69675 ⁵	81446	34073 ⁸	
	Exc. Wagon		69675 ⁵	81446	34073 ⁸		69724	81514	43049 ⁸ 49131 ³⁰
71-75	Wagon		69675 ⁵	81446	34073 ⁸		69604	81492	49152 ³⁰
65-70	Todos		82110		69724	81514	43049 ⁸ 49128 ³⁰
63-64	Todos		82099		69724	81514	43049 ⁸ 49128 ³⁰
58-62	Todos		82099	
58-60	Exc. Suspensión de Aire y Wagon		82099		81318
	Wagon, Exc. Suspensión de Aire		82099		82156
50-57	Todos		82026		82156





CHIEFTAIN

58	Todos		82099	
	Exc. Suspensión de Aire y Wagon		82099		81318
	Wagon, Exc. Suspensión de Aire		82099		82156
49-57	Todos		82026		82156











EXECUTIVE

67-70	Todos		82110		69724	81514	43049 ⁸ 49128 ³⁰
-------	-------	---	------	-------	------	------	------	---	-------	-------	------	------	---

FIERO

88	Todos		81670	
84-87	Todos		69727		G55512



FIREBIRD

93-02	Todos		G51204	142412 ⁵³		69676	81481	75676	49203 ⁷
82-92	Todos		G56700		69676	81481	75676	49203 ⁷
70-81	Todos		69675 ⁵	81446	34073 ⁸		69624	81095	43084 ⁸ 49135 ³⁰
68-69	Todos		69600	81494		69606	81495
67	Todos		69600	81494		82040	49122 ⁷

FIREBIRD READYMOUNTS

		Delantero	Trasero
93-02	Izquierdo	G57107 ⁴⁰
	Derecho	G57108 ⁴⁰

FIREFLY

95-99	Non-ABS		G55891		G55772
-------	---------	---	--------	------	------	------	------	---	--------	------	------	------	------

4 Número de futuro, las cantidades disponibles Q4 2016.

7 Paquetes en pares; kit de mangueras de aire incluido

30 Para Vehículos GM equipados con sistemas de nivelación de fábrica, vea Ref. A.

43 Strut ReadyMount, no incluye resortes por el diseño del vehículo. Consulte la Ref. D para el procedimiento de reemplazo en una Susp. Elec. Ajustable con un producto no ajustable

Texto en Negritas - Número de Parte Nuevo / Futuro



5 Use el kit 140719 para reemplazar partes del EO de montaje inferior cuando los pernos se rompan o los tornillos autoroscantes no se puedan utilizar más.

8 Paquetes en pares

40 Strut ReadyMount. Ensamble Completo

63 El Kit de Montaje incluye: Aislador Parachoques. Es probable reutilizar algunas partes del E.O.







AMORTIGUADORES Y STRUTS

Año	Notas de Aplicación	From 					Rear 				
		Ultra	ProGuard\ Guardian	LTV\ Max Control	Protector de Strut\ Bases de Strut	HiJacker\ Soporte\ Hidráulico	Ultra	ProGuard\ Guardian	LTV\ Max Control	Protector de Strut\ Bases de Strut	HiJacker\ Soporte\ Hidráulico





PONTIAC

PONTIAC













FIREFLY (cont)

94	Todos	 G55891	142293 ⁵⁴	 G55772	142295 ⁵³
89-91	Todos	 G55891	142293 ⁵⁴	 G55772	142295 ⁵³
85-88	Todos	 G55749	

















G1

00-05	Izquierdo	 G52053	
	Derecho	 G52052	

G2

11-13	Izquierdo	 G52223	 70015
	Derecho	 G52224	 70015
06-10	Izquierdo	 G52223	143239	 70015
	Derecho	 G52224	143239	 70015
00-05	Izquierdo	 G52053	
	Derecho	 G52052	



G3

10	Todos		 G51747
	Izquierdo	 G56886	143239 ⁵³	 G51747	143375 ⁵³
	Derecho	 G56887	143239 ⁵³	 G51747	143375 ⁵³
04-09	Todos		143309	 G51747
09	Izquierdo	 G56886	143239 ⁵³ 143309	 G51747	143375 ⁵³
	Derecho	 G56887	143239 ⁵³ 143309	 G51747	143375 ⁵³
07-08	Izquierdo	 G56886	143309	 G51747	143375 ⁵³
	Derecho	 G56887	143309	 G51747	143375 ⁵³

G3 READYMOUNTS

		Delantero	Trasero
10	Izquierdo	G57130
	Derecho	G57131
09	Izquierdo	G57130⁴⁰
	Derecho	G57131⁴⁰

G5

07-09	Todos	 G56810	143323 ⁵³	 69587
-------	-------	--	------	------	----------------------	------	---	------	------	------	------

G5 READYMOUNTS

		Delantero	Trasero
07-09	Izquierdo	G57047⁴⁰
	Derecho	G57048⁴⁰





40 Strut ReadyMount. Ensamble Completo

53 Montaje de Strut. Es probable reutilizar algunas partes del E.O.

54 Kit con Montaje y Rodamiento. Es probable que reutilizar algunas partes del E.O.





Texto en Negritas - Número de Parte Nuevo / Futuro

AMORTIGUADORES Y STRUTS

Año	Notas de Aplicación										
			Ultra	ProGuard\ Guardian	LTV\ Max Control	Protector de Strut\ Bases de Strut	HiJacker\ Soporte\ Hidráulico		Ultra	ProGuard\ Guardian	LTV\ Max Control

PONTIAC G6









































PONTIAC

05-10	Izquierdo		G52028	143354 ⁵³		G69590	143425 ⁵³
	Derecho		G52029	143355 ⁵³		G69590	143425 ⁵³

G6 READYMOUNTS

		Delantero	Trasero
06-10	Izquierdo	G57121
	Derecho	G57122
05-10	Exc. Convertible y 4Cyl Izquierdo	G57069 ⁴⁰
	Exc. Convertible y 4Cyl Derecho	G57070 ⁴⁰

GRAND AM

99-05	Todos		G55974		G56501	142532 ⁵³
96-98	Izquierdo Exc. Suspensión Electrónica Ajustable		G56720	142227 ⁵⁸		G69407 ⁹	81790	141974 ⁵³	49614 ⁷
	Derecho Exc. Suspensión Electrónica Ajustable		G56719	142227 ⁵⁸		G69407 ⁹	81790	141974 ⁵³	49614 ⁷
95	Izquierdo Exc. Suspensión Electrónica Ajustable		G56720 ⁹	142227 ⁵⁸		G69407 ⁹	81790	141974 ⁵³	49614 ⁷
	SE, Derecho Exc. Suspensión Electrónica Ajustable		G56719 ⁹	142227 ⁵⁸		G69407 ⁹	81790	141974 ⁵³	49614 ⁷
92-94	Todos			G69749	81530	141974 ⁵³	49371 ³⁰
	GT, Izquierdo Suspensión FE3		G56723		G69749	81530	141974 ⁵³	49371 ³⁰
	GT, Derecho Suspensión FE3		G56724		G69749	81530	141974 ⁵³	49371 ³⁰
	SE, Izquierdo Exc. FE3 y Control de Manejo Electrónico		G56720 ⁹	142227 ⁵⁸		G69749	81530	141974 ⁵³	49371 ³⁰
	SE, Derecho Exc. FE3 y Control de Manejo Electrónico		G56719 ⁹	142227 ⁵⁸		G69749	81530	141974 ⁵³	49371 ³⁰
87-91	Izquierdo		G56706		G69749	81530	141974 ⁵³	49371 ³⁰
	Derecho		G56705		G69749	81530	141974 ⁵³	49371 ³⁰
	Suspensión Estándar		142762 ⁶⁵	
85-86	Todos			G69749	81530	141974 ⁵³	49371 ³⁰
	Izquierdo Struts de EO no reconstruibles		G56706		G69749	81530	141974 ⁵³	49371 ³⁰
	Derecho Struts de EO no reconstruibles		G56705		G69749	81530	141974 ⁵³	49371 ³⁰
	Struts Reconstruibles de EO		G44451 ⁹⁸		G69749	81530	141974 ⁵³	49371 ³⁰
	Suspensión Estándar		142762 ⁶⁵		G69749	81530	141974 ⁵³	49371 ³⁰
78-80	Todos		G69600	81494	34051 ⁸		G69604	81492	43060 ⁸ 49334 ³⁰
73-75	Todos		G69600	81494	34051 ⁸		G69604	81492	43060 ⁸ 49152 ³⁰

7 Paquetes en pares; kit de mangueras de aire incluido

9 Vea Ref.D para los procedimientos de reemplazo de una Susp. Elect. Ajust. con un producto no ajust.

40 Strut ReadyMount. Ensemble Completo

58 El Kit de Montaje incluye: Rodamiento de Suspensión. Es probable reutilizar algunas partes del E.O.

98 Nota: El nivel de dificultad para instalar este producto es moderadamente alto. Por favor revise las instrucciones cuidadosamente antes de comenzar.

Texto en Negritas - Número de Parte Nuevo / Futuro

8 Paquetes en pares

30 Para Vehículos GM equipados con sistemas de nivelación de fábrica, vea Ref. A.

53 Montaje de Strut. Es probable reutilizar algunas partes del E.O.

65 El Kit de Montaje incluye: Asiento de Resorte Superior con Aislador. Es probable reutilizar algunas partes del E.O.

AMORTIGUADORES Y STRUTS

Año	Notas de Aplicación	Front					Rear				
		Ultra	ProGuard\ Guardian	LTV\ Max Control	Protector de Strut\ Bases de Strut	HiJacker\ Soporte\ Hidráulico	Ultra	ProGuard\ Guardian	LTV\ Max Control	Protector de Strut\ Bases de Strut	HiJacker\ Soporte\ Hidráulico

PONTIAC

PONTIAC

GRAND AM READYMOUNTS

		Delantero	Trasero
99-05	Todos	G56927 ⁴⁰	G56928 ⁴⁰
96-98	Izquierdo Exc. Suspensión Electrónica Ajustable	G56917 ⁴⁰
	Derecho Exc. Suspensión Electrónica Ajustable	G56916 ⁴⁰
95	Izquierdo Exc. Suspensión Electrónica Ajustable	G56917 ⁴
	Derecho Exc. Suspensión Electrónica Ajustable	G56916 ⁴
92-94	SE, Izquierdo Exc. FE3 y Control de Manejo Electrónico	G56919 ⁴⁰

GRAND LEMANS

78-83	Todos	69600	81494	34051 ⁸	69604	81492	43060 ⁸ 49334 ³⁰
75-77	Todos	69600	81494	34051 ⁸	69604	81492	43060 ⁸ 49152 ³⁰

GRAND PRIX

04-08	Todos	G56812	142524 ⁵⁸ 142525 ⁵³ 142526 ⁵⁴
	Exc. Modelos c/ Ruedas de 17" o 18"	G56812	142524 ⁵⁸ 142525 ⁵³ 142526 ⁵⁴	G55949
	Izquierdo	G56812	142524 ⁵⁸ 142525 ⁵³ 142526 ⁵⁴	143073 ⁵³
	Modelos con Llantas de 17" o 18"	G56812	142524 ⁵⁸ 142525 ⁵³ 142526 ⁵⁴	G52244
	Derecho	G56812	142524 ⁵⁸ 142525 ⁵³ 142526 ⁵⁴	143074 ⁵³
97-03	Todos	G55948	142524 ⁵⁸ 142525 ⁵³ 142526 ⁵⁴
	Exc. Modelos c/ Ruedas de 17" o 18"	G55948	142524 ⁵⁸ 142525 ⁵³ 142526 ⁵⁴	G55949
	Izquierdo	G55948	142524 ⁵⁸ 142525 ⁵³ 142526 ⁵⁴	143073 ⁵³
	Derecho	G55948	142524 ⁵⁸ 142525 ⁵³ 142526 ⁵⁴	143074 ⁵³
90-96	Todos	G44459 ³⁶	142143 ⁵³	G56708
88-89	Todos	G44459 ³⁶	G56708
69-87	Todos	69600	81494	34051 ⁸	69604	81492	43060 ⁸ 49334 ³⁰
65-68	Todos	82110	69724	81514	49128 ³⁰
63-64	Todos	82099	69724	81514	49128 ³⁰
62	Todos	82099

GRAND PRIX READYMOUNTS

		Delantero	Trasero
04-08	Todos	G57141 ³
	Izquierdo Exc. Modelos c/ Ruedas de 17" o 18"	G57141 ³	G56924 ⁴⁰
	Derecho Exc. Modelos c/ Ruedas de 17" o 18"	G57141 ³	G56925 ⁴⁰
97-03	Todos	G57060 ⁴⁰
	Izquierdo Exc. Modelos c/ Ruedas de 17" o 18"	G57060 ⁴⁰	G56924 ⁴⁰
	Derecho Exc. Modelos c/ Ruedas de 17" o 18"	G57060 ⁴⁰	G56925 ⁴⁰
88-96	Todos	G56727 ⁴²

3 Número de parte futuro

8 Paquetes en pares

36 Requiere una herramienta especial de instalación para struts.

42 Strut ReadyMount, no incluye resortes por el diseño del vehículo.

54 Kit con Montaje y Rodamiento. Es probable que reutilizar algunas partes del E.O.

4 Número de futuro, las cantidades disponibles Q4 2016.

30 Para Vehículos GM equipados con sistemas de nivelación de fábrica, vea Ref. A.





40 Strut ReadyMount. Ensamble Completo

53 Montaje de Strut. Es probable reutilizar algunas partes del E.O.

58 El Kit de Montaje incluye: Rodamiento de Suspensión. Es probable reutilizar algunas partes del E.O.

Texto en Negritas - Número de Parte Nuevo / Futuro



AMORTIGUADORES Y STRUTS

Año	Notas de Aplicación										
			Ultra	ProGuard\ Guardian	LTV\ Max Control	Protector de Strut\ Bases de Strut	HiJacker\ Soporte\ Hidráulico		Ultra	ProGuard\ Guardian	LTV\ Max Control



PONTIAC

PONTIAC













GRAND SAFARI

71-78	Todos		69675 ⁵	81446	34073 ⁸		69604	81492	43060 ⁸ 49152 ³⁰
-------	-------	---	--------------------	-------	------	------	--------------------	---	-------	-------	------	------	---



















GRANDVILLE

71-75	Todos		69600	81494	34051 ⁸		69604	81492	43060 ⁸ 49152 ³⁰
-------	-------	---	-------	-------	------	------	--------------------	---	-------	-------	------	------	---



GTO

04-06	Izquierdo		G52123	143459 ⁵³		70032
	Derecho		G52124	143459 ⁵³		70032
68-73	Todos		69600	81494		69604	81492	43060 ⁸ 49152 ³⁰
64-67	Todos		82138	
	Exc. Suspensión HD		82138		69724	81514	43049 ⁸ 49131 ³⁰
	Suspensión HD		82138		69604	81492	43060 ⁸ 49152 ³⁰













J2000 / SUNBIRD

85	Todos			69749	81530	141974 ⁵³	49371 ³⁰
	Izquierdo Struts de EO no reconstruibles		G56706		69749	81530	141974 ⁵³	49371 ³⁰
	Derecho Struts de EO no reconstruibles		G56705		69749	81530	141974 ⁵³	49371 ³⁰
	Struts Reconstruibles de EO		G44451 ⁹⁸		69749	81530	141974 ⁵³	49371 ³⁰
84	Todos		142762 ⁶⁵		69749	81530	141974 ⁵³	49371 ³⁰
	Izquierdo Struts de EO no reconstruibles		G56706	142762 ⁶⁵		69749	81530	141974 ⁵³	49371 ³⁰
	Derecho Struts de EO no reconstruibles		G56705	142762 ⁶⁵		69749	81530	141974 ⁵³	49371 ³⁰
	Struts Reconstruibles de EO		G44451 ⁹⁸	142762 ⁶⁵		69749	81530	141974 ⁵³	49371 ³⁰
82-83	Todos		142762 ⁶⁵		69749	81530	49371 ³⁰

LAURENTIAN

76-81	Todos		69675 ⁵	81446	34073 ⁸		69724	81514	43049 ⁸ 49131 ³⁰
-------	-------	---	--------------------	-------	------	------	--------------------	---	-------	-------	------	------	---

LEMANS

88-93	Todos		G44903 ⁹⁸		81742
68-81	Todos		69600	81494	34051 ⁸		69604	81492	43060 ⁸ 49334 ³⁰
64-67	Todos		82138	
	Exc. Suspensión HD		82138		69724	81514	43049 ⁸ 49131 ³⁰
	Suspensión HD		82138		69604	81492	43060 ⁸ 49152 ³⁰
63	Todos		82129	

5 Use el kit 140719 para reemplazar partes del EO de montaje inferior cuando los pernos se rompan o los tornillos autoroscantes no se puedan utilizar más.

30 Para Vehículos GM equipados con sistemas de nivelación de fábrica, vea Ref. A.

65 El Kit de Montaje incluye: Asiento de Resorte Superior con Aislador. Es probable reutilizar algunas partes del E.O.

Texto en Negritas - Número de Parte Nuevo / Futuro

8 Paquetes en pares

53 Montaje de Strut. Es probable reutilizar algunas partes del E.O.

98 Nota: El nivel de dificultad para instalar este producto es moderadamente alto. Por favor revise las instrucciones cuidadosamente antes de comenzar.

AMORTIGUADORES Y STRUTS

Año	Notas de Aplicación	Front					Rear				
		Ultra	ProGuard\ Guardian	LTV\ Max Control	Protector de Strut\ Bases de Strut	HiJacker\ Soporte\ Hidráulico	Ultra	ProGuard\ Guardian	LTV\ Max Control	Protector de Strut\ Bases de Strut	HiJacker\ Soporte\ Hidráulico

PONTIAC

PONTIAC

MONTANA

07-09	FWD	142526 ⁵⁴	G63776
06-09	Todos	142526 ⁵⁴
	SV6, Exc. Suspensión Autonivelable	G52025	142526 ⁵⁴
06	FWD, Exc. Suspensión con Nivelación Neumática	142526 ⁵⁴	G63776
04-05	Todos	142524 ⁵⁸ 142525 ⁵³ 142526 ⁵⁴	61659 81924
	Exc. Suspensión con Nivelación Neumática	142524 ⁵⁸ 142525 ⁵³ 142526 ⁵⁴	G63776	61659 81924
	Base	G55948	142524 ⁵⁸ 142525 ⁵³ 142526 ⁵⁴	61659 81924
	FWD, Suspensión con Nivelación Neumática; Exc. Suspensión Trasera Independiente	142524 ⁵⁸ 142525 ⁵³ 142526 ⁵⁴	61659 81924	49230 ⁷
05	SV6, Exc. Suspensión Autonivelable	G52025	142524 ⁵⁸ 142525 ⁵³ 142526 ⁵⁴	61659 81924
02-03	Todos	142525 ⁵³ 142526 ⁵⁴	61659 81924
	Exc. Suspensión con Nivelación Neumática	142525 ⁵³ 142526 ⁵⁴	G63776	61659 81924
	Base	G55948	142525 ⁵³ 142526 ⁵⁴	61659 81924
	FWD, Suspensión con Nivelación Neumática; Exc. Suspensión Trasera Independiente	142525 ⁵³ 142526 ⁵⁴	61659 81924	49230 ⁷
	Mini Passenger Van	142524 ⁵⁸ 142525 ⁵³ 142526 ⁵⁴	61659 81924
99-01	Todos	142524 ⁵⁸ 142525 ⁵³ 142526 ⁵⁴	61659 81924
	Exc. Suspensión con Nivelación Neumática	142524 ⁵⁸ 142525 ⁵³ 142526 ⁵⁴	G63776	61659 81924
	Base	G55948	142524 ⁵⁸ 142525 ⁵³ 142526 ⁵⁴	61659 81924
	FWD, Suspensión con Nivelación Neumática; Exc. Suspensión Trasera Independiente	142524 ⁵⁸ 142525 ⁵³ 142526 ⁵⁴	61659 81924	49230 ⁷

MONTANA READYMOUNTS

		Delantero	Trasero
05-09	SV6, FWD	G57142³
99-05	Base	G57060¹⁰

PARISIENNE

76-86	Todos	69675 ⁵	81446	34073 ⁸
	Sedan	69675 ⁵	81446	34073 ⁸	69724	81514	43049 ⁸ 49131 ³⁰
	Wagon	69675 ⁵	81446	34073 ⁸	69604	81492	43060 ⁸ 49152 ³⁰

PHOENIX

80-84	Todos	42517
-------	-------	-------	-------	-------	-------	-------	-------	-------	-------	-------

3 Número de parte futuro

7 Paquetes en pares; kit de mangueras de aire incluido

30 Para Vehículos GM equipados con sistemas de nivelación de fábrica, vea Ref. A.

53 Montaje de Strut. Es probable reutilizar algunas partes del E.O.

58 El Kit de Montaje incluye: Rodamiento de Suspensión. Es probable reutilizar algunas partes del E.O.

Texto en Negritas - Número de Parte Nuevo / Futuro





5 Use el kit 140719 para reemplazar partes del EO de montaje inferior cuando los pernos se rompan o los tornillos autoroscantes no se puedan utilizar más.

8 Paquetes en pares

40 Strut ReadyMount. Ensamble Completo

54 Kit con Montaje y Rodamiento. Es probable que reutilizar algunas partes del E.O.











AMORTIGUADORES Y STRUTS

Año	Notas de Aplicación										
			Ultra	ProGuard\ Guardian	LTV\ Max Control	Protector de Strut\ Bases de Strut	HiJacker\ Soporte\ Hidráulico		Ultra	ProGuard\ Guardian	LTV\ Max Control

PONTIAC

PONTIAC



PHOENIX (cont)

84	Todos		142223 ⁵³ 142749 ⁶⁵		69723	81517	141974 ⁵³	49370 ³⁰ 42517
	Exc. Suspensión HD		G55505		42517
	Suspensión HD		G55514		42517
80-83	Todos		G55505	142223 ⁵³		69723	81517	49370 ³⁰ 42517
77-79	Todos		69600	81494	34051 ⁸		82093	49193 ⁷

PHOENIX READYMOUNTS

										Delantero	Trasero	
84	Suspensión HD										G56908 ⁴⁰



PURSUIT

05-06	Todos		G56810	143323 ⁵³		69587
-------	-------	---	--------	------	------	----------------------	------	---	-------	------	------	------	------



PURSUIT READYMOUNTS

										Delantero	Trasero		
05-06	Izquierdo											G57047 ⁴⁰
	Derecho											G57048 ⁴⁰











SAFARI

87-89	Todos		69675 ⁵	81446	34073 ⁸		69604	81492	43060 ⁸ 49152 ³⁰
-------	-------	--	--------------------	-------	------	------	--------------------	--	-------	-------	------	------	---



SOLSTICE

06-09	Todos		G51935		G51936
-------	-------	---	--------	------	------	------	------	---	--------	------	------	------	------













STAR CHIEF

65-66	Todos		82110		69724	81514	49128 ³⁰
63-64	Todos		82099		69724	81514	49128 ³⁰
61-62	Todos		82099	
58-60	Todos		82099		81318 82156
54-57	Todos		82026		82156

STREAMLINER

49-52	Todos		82026		82156
-------	-------	---	------	-------	------	------	------	---	------	-------	------	------	------

SUNBIRD

94	Izquierdo		G56706	142762 ⁶⁵		69749	81530	141974 ⁵³	49371 ³⁰
	Derecho		G56705	142762 ⁶⁵		69749	81530	141974 ⁵³	49371 ³⁰
91-93	Izquierdo		G56706	142762 ⁶⁵		69749	81530	49371 ³⁰
	Derecho		G56705	142762 ⁶⁵		69749	81530	49371 ³⁰
	Suspensión Deportiva			141974 ⁵³
88-90	Izquierdo		G56706	142762 ⁶⁵		69749	81530	141974 ⁵³	49371 ³⁰

5 Use el kit 140719 para reemplazar partes del EO de montaje inferior cuando los pernos se rompan o los tornillos autoroscantes no se puedan utilizar más.

8 Paquetes en pares

40 Strut ReadyMount. Ensamble Completo

65 El Kit de Montaje incluye: Asiento de Resorte Superior con Aislador. Es probable reutilizar algunas partes del E.O.

7 Paquetes en pares; kit de mangueras de aire incluido

30 Para Vehículos GM equipados con sistemas de nivelación de fábrica, vea Ref. A.

53 Montaje de Strut. Es probable reutilizar algunas partes del E.O.

Texto en Negritas - Número de Parte Nuevo / Futuro

AMORTIGUADORES Y STRUTS

Año	Notas de Aplicación	From					Rear				
		Ultra	ProGuard\ Guardian	LTV\ Max Control	Protector de Strut\ Bases de Strut	HiJacker\ Soporte\ Hidráulico	Ultra	ProGuard\ Guardian	LTV\ Max Control	Protector de Strut\ Bases de Strut	HiJacker\ Soporte\ Hidráulico

PONTIAC

PONTIAC

SUNBIRD (cont)

88-90	Derecho	G56705	142762 ⁶⁵	69749	81530	141974 ⁵³	49371 ³⁰
86-87	Todos	142762 ⁶⁵	69749	81530	141974 ⁵³	49371 ³⁰
	Izquierdo Struts de EO no reconstruibles	G56706	142762 ⁶⁵	69749	81530	141974 ⁵³	49371 ³⁰
	Derecho Struts de EO no reconstruibles	G56705	142762 ⁶⁵	69749	81530	141974 ⁵³	49371 ³⁰
	Struts Reconstruibles de EO	G44451 ⁹⁸	142762 ⁶⁵	69749	81530	141974 ⁵³	49371 ³⁰
76-80	Todos	82129	81438

SUNBIRD READYMOUNTS

		Delantero		Trasero	
92-94	Izquierdo	G56921 ⁴⁰		
	Derecho	G56920 ⁴⁰		

SUNBURST

85-88	Todos	G55719	81558
-------	-------	--------	------	------	------	------	------	-------	------	------	------

SUNFIRE

99-05	Todos	G55698	143035 ⁵⁴	G55825	142413 ⁵³
95-98	Todos	G55698	142227 ⁵⁸	G55825	142413 ⁵³

SUNFIRE READYMOUNTS

		Delantero		Trasero	
99-05	Todos	G56951 ⁴⁰		G56938 ⁴⁰	
95-98	Todos	G56939 ⁴⁰		G56938 ⁴⁰	

SUNRUNNER

94-97	Todos	142294 ⁵⁴	G63799	61560 81904	49613 ⁷
	Sin ABS	G56518	142294 ⁵⁴	G63799	61560 81904	49613 ⁷

SUPER CHIEF

58	Todos	82099	81318 82156
57	Todos	82026	82156

T1000

81-87	Todos	81322	81340
-------	-------	------	-------	------	------	------	------	-------	------	------	------

TEMPEST

87-91	Izquierdo	G56706	69749	81530	141974 ⁵³	49371 ³⁰
	Derecho	G56705	69749	81530	141974 ⁵³	49371 ³⁰
68-70	Todos	69600	81494	69604	81492	43060 ⁸ 49152 ³⁰
64-67	Todos	82138
	Exc. Suspensión HD	82138	69724	81514	43049 ⁸ 49131 ³⁰

7 Paquetes en pares; kit de mangueras de aire incluido

30 Para Vehículos GM equipados con sistemas de nivelación de fábrica, vea Ref. A.

53 Montaje de Strut. Es probable reutilizar algunas partes del E.O.

58 El Kit de Montaje incluye: Rodamiento de Suspensión. Es probable reutilizar algunas partes del E.O.

98 Nota: El nivel de dificultad para instalar este producto es moderadamente alto. Por favor revise las instrucciones cuidadosamente antes de comenzar.

Texto en Negritas - Número de Parte Nuevo / Futuro





8 Paquetes en pares

40 Strut ReadyMount. Ensemble Completo

54 Kit con Montaje y Rodamiento. Es probable que reutilizar algunas partes del E.O.

65 El Kit de Montaje incluye: Asiento de Resorte Superior con Aislador. Es probable reutilizar algunas partes del E.O.





AMORTIGUADORES Y STRUTS

Año	Notas de Aplicación										
			Ultra	ProGuard\ Guardian	LTV\ Max Control	Protector de Strut\ Bases de Strut	HiJacker\ Soporte\ Hidráulico		Ultra	ProGuard\ Guardian	LTV\ Max Control

PONTIAC

PONTIAC











TEMPEST (cont)

64-67	Suspensión HD		82138		69604	81492	43060 ⁸ 49152 ³⁰
61-63	Todos		82129	

TEMPEST READYMOUNTS

		Delantero			Trasero	
87-91	Izquierdo	G56921 ⁴⁰			
	Derecho	G56920 ⁴⁰			







TORRENT

07-09	Todos		143469 ⁵³		G64015	61718
	Izquierdo Exc. Suspensión Deportiva		G52127	143469 ⁵³		G64015	61718
	Derecho Exc. Suspensión Deportiva		G52128	143469 ⁵³		G64015	61718
06	Izquierdo		G56773	143363 ⁵³		G64015	61718
	Derecho		G56774	143363 ⁵³		G64015	61718

TORRENT READYMOUNTS

		Delantero			Trasero	
06	Izquierdo	G57110 ⁴⁰			
	Derecho	G57111 ⁴⁰			





















TRANS SPORT

99	Todos			G63776
97-98	Todos		G55948	142524 ⁵⁸ 142525 ⁵³ 142526 ⁵⁴		G63776	61659 81924	49230 ⁷
90-96	Todos		G55992	142223 ⁵³ 142749 ⁶⁵		G63914	61503	141974 ⁵³	49370 ³⁰



TRANS SPORT READYMOUNTS

		Delantero			Trasero	
97-98	Todos	G57060 ⁴⁰			

VENTURA

74-77	Todos		69600	81494	34051 ⁸		82093	49193 ⁷
73	Todos		69600	81494	34051 ⁸		82093
	Exc. Suspensión HD		69600	81494	34051 ⁸		82093	49193 ⁷
	Suspensión HD		69600	81494	34051 ⁸		69724	81514 82093	49157 ⁷
71-72	Todos		69600	81494	
	Resorte Trasero de Hoja Sencilla		69600	81494		49193 ⁷
	Resorte Trasero de Hojas Múltiples		69600	81494		69724	81514	49157 ⁷
	Leaf(RearSpringType)		69600	81494		82093	43049 ⁸
61	Todos		82099	
60	Todos		82099		81318 82156

VIBE

09-10	Izquierdo		G52245	
-------	-----------	---	--------	------	------	------	------	---	------	------	------	------	------

7 Paquetes en pares; kit de mangueras de aire incluido

30 Para Vehículos GM equipados con sistemas de nivelación de fábrica, vea Ref. A.

53 Montaje de Strut. Es probable reutilizar algunas partes del E.O.

58 El Kit de Montaje incluye: Rodamiento de Suspensión. Es probable reutilizar algunas partes del E.O.

Texto en Negritas - Número de Parte Nuevo / Futuro

8 Paquetes en pares

40 Strut ReadyMount. Ensamble Completo

54 Kit con Montaje y Rodamiento. Es probable que reutilizar algunas partes del E.O.

65 El Kit de Montaje incluye: Asiento de Resorte Superior con Aislador. Es probable reutilizar algunas partes del E.O.

AMORTIGUADORES Y STRUTS

Año	Notas de Aplicación	Front					Rear				
		Ultra	ProGuard\ Guardian	LTV\ Max Control	Protector de Strut\ Bases de Strut	HiJacker\ Soporte\ Hidráulico	Ultra	ProGuard\ Guardian	LTV\ Max Control	Protector de Strut\ Bases de Strut	HiJacker\ Soporte\ Hidráulico

PONTIAC

PONTIAC

VIBE (cont)

09-10	Derecho	G52246
	FWD	G51898
03-08	Izquierdo	G52013	143093 ⁵³	143094 ⁵³
	Derecho	G52014	143093 ⁵³	143094 ⁵³
	FWD	G51736
03-06	AWD	G51768

VIBE READYMOUNTS

		Delantero	Trasero
03-08	FWD, Izquierdo	G57067
	FWD, Derecho	G57068

WAVE

05-08	Izquierdo	G56886	143239 ⁵³	G51747	143375 ⁵³
	Derecho	G56887	143239 ⁵³	G51747	143375 ⁵³

WAVE READYMOUNTS

		Delantero	Trasero
05-08	Izquierdo	G57130 ¹⁰
	Derecho	G57131 ¹⁰

PORSCHE

PORSCHE

924

87-88	Todos	G44850 ⁹⁸	G69760
77-82	Todos	G44850 ⁹⁸	G69616

944

89-91	Todos	G69760
86-88	Todos	G44850 ⁹⁸	G69760
83-85	Todos	G44850 ⁹⁸	G69616

CAYENNE

03-10	Izquierdo	G52348
	Derecho	G52349

RAM

RAM

1500

13-15	4WD	G51856	G64044
11-14	Todos	G64044
	RWD	G64043	G64044
11-12	4WD	G51856	143389 ⁵³	G64044





40 Strut ReadyMount. Ensamble Completo

53 Montaje de Strut. Es probable reutilizar algunas partes del E.O.

98 Nota: El nivel de dificultad para instalar este producto es moderadamente alto. Por favor revise las instrucciones cuidadosamente antes de comenzar.

Texto en Negritas - Número de Parte Nuevo / Futuro

AMORTIGUADORES Y STRUTS

Año	Notas de Aplicación										
			Ultra	ProGuard\ Guardian	LTV\ Max Control	Protector de Strut\ Bases de Strut	HiJacker\ Soporte\ Hidráulico		Ultra	ProGuard\ Guardian	LTV\ Max Control

RAM

RAM























1500 (cont)

10	4WD		G64011		G64044
----	-----	---	--------	------	------	------	------	---	--------	------	------	------	------















1500 READYMOUNTS

11	4WD									Delantero	Trasero
										G57147³

2500

14-15	4WD		G64009	
15	RWD, Standard Cab Pickup		G64043	
14	RWD, Standard Cab Pickup		G64043		G63970
11-13	Todos			77950
	RWD		77949		77950
	RWD, Standard Cab Pickup		G64043		G63970	77950
13	4WD		G64009	77948		G64013	77950
11-12	4WD		G64009	77948		61716	77950
	4WD, PBV 8800			G64013	77950
10	4WD		G64009	
	RWD, Standard Cab Pickup		G64043	



3500

14-15	4WD		G64009	
15	RWD, Standard Cab Pickup		G64043	
14	RWD, Standard Cab Pickup		G64043		G63970
11-13	Todos			77950
	4WD		G64009	77948		77950
	RWD		77949		77950
	RWD, Standard Cab Pickup		G64043		G63970	77950



RENAULT

RENAULT





CLIO

02-08	Todos		G56648		G51706
-------	-------	---	--------	------	------	------	------	---	--------	------	------	------	------

KANGOO

03-14	Todos		G52040		70002
-------	-------	---	--------	------	------	------	------	---	-------	------	------	------	------

KOLEOS

09-14	Izquierdo		G52173		G64050
	Derecho		G52174		G64050



MEGANE I

01-04	Todos		G56694		69588
-------	-------	---	--------	------	------	------	------	---	-------	------	------	------	------

3 Número de parte futuro

Texto en Negritas - Número de Parte Nuevo / Futuro

AMORTIGUADORES Y STRUTS

Año	Notas de Aplicación										
		Ultra	ProGuard\ Guardian	LTV\ Max Control	Protector de Strut\ Bases de Strut	HiJacker\ Soporte\ Hidráulico	Ultra	ProGuard\ Guardian	LTV\ Max Control	Protector de Strut\ Bases de Strut	HiJacker\ Soporte\ Hidráulico

RENAULT

RENAULT

MEGANE II

05-10	Todos	G52011	143348	G70006
-------	-------	--------	------	------	--------	------	--------	------	------	------	------

SANDERO / SANDERO STEPWAY

10-12	Todos	G52211	G70011
-------	-------	--------	------	------	------	------	--------	------	------	------	------

SCALA

10-13	Izquierdo	G52055	G51279
	Derecho	G52056	G51279

SCENIC

01-04	Todos	G56694	G69579
-------	-------	--------	------	------	------	------	--------	------	------	------	------

TRAFIC

07-13	Todos	G52216	G64061
-------	-------	--------	------	------	------	------	--------	------	------	------	------

SAAB

SAAB

9-3

09-11	Todos	G70039
03-08	Izquierdo	G52175	G70039
	Derecho	G52176	G70039
99-02	Todos	G244002 ⁹⁸
	Exc. Viggen	G244002 ⁹⁸	143206 ⁵³	G70020

9-5

02-06	Todos	G52066	G51885
99-01	Todos	G51885

9-7X

05-09	Todos	G51718	143241 ⁵³	G63842	61717
-------	-------	--------	------	------	----------------------	------	--------	-------	------	------	------

9-7X READYMOUNTS

05-09	Todos								Delantero	Trasero
								G57022 ⁴⁰	

93

56-57	Todos	82607	81676
-------	-------	------	-------	------	------	------	------	-------	------	------	------



40 Strut ReadyMount. Ensamble Completo

53 Montaje de Strut. Es probable reutilizar algunas partes del E.O.

98 Nota: El nivel de dificultad para instalar este producto es moderadamente alto. Por favor revise las instrucciones cuidadosamente antes de comenzar.

Texto en Negritas - Número de Parte Nuevo / Futuro



AMORTIGUADORES Y STRUTS

Año	Notas de Aplicación	Front					Rear				
			Ultra	ProGuard\ Guardian	LTV\ Max Control	Protector de Strut\ Bases de Strut	HiJacker\ Soporte\ Hidráulico		Ultra	ProGuard\ Guardian	LTV\ Max Control



SAAB

SAAB



93B

58-59	Todos		82607		81676
-------	-------	---	-------	-------	-------	-------	-------	---	-------	-------	-------	-------	-------





95

59-73	Todos		82607	
-------	-------	---	-------	-------	-------	-------	-------	---	-------	-------	-------	-------	-------





















96

61-73	Todos		82607	
-------	-------	---	-------	-------	-------	-------	-------	---	-------	-------	-------	-------	-------



99

79-80	Todos		82607		69671
69-78	Todos		82607		81270	49105 ⁷





900

94-98	Todos			69891
	Naturally Aspirated(Eng Asp)		G44495 ⁹⁸		69891
	Turbocharged(Eng Asp)		G44461 ⁹⁸		69891
93	Todos		69670	
	Fab. desde 6/30/93		69670		69891
	Fabricado antes de Jul/93		69670		69671
	Naturally Aspirated(Eng Asp) Fab. desde 6/30/93		G44495 ⁹⁸	
	Turbocharged(Eng Asp) Fab. desde 6/30/93		G44461 ⁹⁸	
80-92	Todos		69670		69671
79	Todos		69670	



9000

86-98	Sistema Hidráulico de Autonivelación			69773
-------	--------------------------------------	---	-------	-------	-------	-------	-------	---	-------	-------	-------	-------	-------

GT750

60-62	Todos		82607	
58-59	Todos		82607		81676



GT850

63	Todos		82607		81676
----	-------	---	-------	-------	-------	-------	-------	---	-------	-------	-------	-------	-------









SATURN

SATURN

ASTRA

08-09	Todos			69587
-------	-------	---	-------	-------	-------	-------	-------	---	-------	-------	-------	-------	-------

AURA

07-09	Izquierdo		G52028	143354 ⁵³	
	Derecho		G52029	143355 ⁵³	
09	Exc. Modelo Hybrid			69590	143425 ⁵³
07-08	Exc. Modelo Hybrid			69590	143425 ⁵³ 143425 ⁵⁴

7 Paquetes en pares; kit de mangueras de aire incluido

54 Kit con Montaje y Rodamiento. Es probable que reutilizar algunas partes del E.O.

53 Montaje de Strut. Es probable reutilizar algunas partes del E.O.

98 Nota: El nivel de dificultad para instalar este producto es moderadamente alto. Por favor revise las instrucciones cuidadosamente antes de comenzar.

Texto en Negritas - Número de Parte Nuevo / Futuro

AMORTIGUADORES Y STRUTS

Año	Notas de Aplicación	Front					Rear				
		Ultra	ProGuard\ Guardian	LTV\ Max Control	Protector de Strut\ Bases de Strut	HiJacker\ Soporte\ Hidráulico	Ultra	ProGuard\ Guardian	LTV\ Max Control	Protector de Strut\ Bases de Strut	HiJacker\ Soporte\ Hidráulico

SATURN

SATURN

AURA READYMOUNTS

		Delantero	Trasero
07-09	4 Cyl; Exc Hybrid Izquierdo	G57121
	4 Cyl; Exc Hybrid Derecho	G57122
	Exc. Modelo Hybrid y 4 cyl Izquierdo	G57069 ⁴⁰
	Exc. Modelo Hybrid y 4 cyl Derecho	G57070 ⁴⁰

ION

04-07	Todos	G56809	143089 ⁵³	G69587
03	Todos	G56809	G69587

ION READYMOUNTS

		Delantero	Trasero
03-07	Izquierdo	G57099 ⁴⁰
	Derecho	G57100 ⁴⁰

L / LS / LW SERIES

05	Izquierdo	G56796	G51759
	Derecho	G56795	G51759
04	Izquierdo	G56796
	Derecho	G56795
03	Izquierdo	G56796	G51759
	Derecho	G56795	G51759
01-02	Izquierdo	G56796	142943 ⁵³	G51759
	Derecho	G56795	142943 ⁵³	G51759
00	Izquierdo	G56796	G51759
	Derecho	G56795	G51759

OUTLOOK

07-10	Todos	G52125	143366	G64040
-------	-------	--------	------	------	--------	------	--------	------	------	------	------

OUTLOOK READYMOUNTS

		Delantero	Trasero
07-10	Todos	G57109 ⁴⁰

RELAY

05-07	Todos	142526 ⁵⁴	G63776	49230
	Exc. Suspensión con Nivelación Neumática	G52025	142526 ⁵⁴	G63776	49230

RELAY READYMOUNTS

		Delantero	Trasero
07	1, 2, 3, FWD	G57142 ³
05-06	2, 3, FWD	G57142 ³

SC / SL / SW SERIES

91-02	Todos	G55801	142244 ⁵⁴	G55800	142245 ⁵³
-------	-------	--------	------	------	----------------------	------	--------	------	------	----------------------	------

3 Número de parte futuro





53 Montaje de Strut. Es probable reutilizar algunas partes del E.O.

Texto en Negritas - Número de Parte Nuevo / Futuro

40 Strut ReadyMount. Ensamble Completo

54 Kit con Montaje y Rodamiento. Es probable que reutilizar algunas partes del E.O.

AMORTIGUADORES Y STRUTS

Año	Notas de Aplicación										
			ProGuard\ Guardian	LTV\ Max Control	Protector de Strut\ Bases de Strut	HiJacker\ Soporte\ Hidráulico		ProGuard\ Guardian	LTV\ Max Control	Protector de Strut\ Bases de Strut	HiJacker\ Soporte\ Hidráulico













SATURN

SATURN

SC / SL / SW SERIES READYMOUNTS

		Delantero	Trasero
91-02	Todos	G57013 ⁴⁰	G57014 ⁴⁰

VUE

08-10	Izquierdo	 G52127	143469 ⁵³	 G63872
	Derecho	 G52128	143469 ⁵³	 G63872
02-07	Todos		143035 ⁵⁴	 G63872
	Izquierdo	 G52026	143035 ⁵⁴	 G63872
	Reemplaza el Montaje en el Kit de Servicio GM #15269823		143368 ⁵³ 143035 ⁵⁴	 G63872
	Derecho	 G52027	143035 ⁵⁴	 G63872









VUE READYMOUNTS

		Delantero	Trasero
02-07	4 Cyl Izquierdo	G57101 ⁴⁰
	4 Cyl Derecho	G57102 ⁴⁰



SCION

SCION







TC

08-10	Izquierdo	 G52096	143406 ⁵³	 G51852
	Derecho	 G52097	143406 ⁵³	 G51852
05-07	Izquierdo	 G52096	143406 ⁵³	 G51852	143094 ⁵³
	Derecho	 G52097	143406 ⁵³	 G51852	143094 ⁵³







XA

04-06	Todos	 G52098	 70028
-------	-------	--	------	------	------	------	---	------	------	------	------

XB

08-12	Izquierdo	 G52264	 70053
	Derecho	 G52265	 70053
04-06	Todos	 G52098	 70028



XD

11	Todos		143417	
08-10	Izquierdo	 G52268	143417	 70055
	Derecho	 G52269	143417	 70055

SEAT

SEAT

ALHAMBRA

02-08	Todos	 G52886	 69924
-------	-------	--	------	------	------	------	---	------	------	------	------



40 Strut ReadyMount. Ensemble Completo

54 Kit con Montaje y Rodamiento. Es probable que reutilizar algunas partes del E.O.

Texto en Negritas - Número de Parte Nuevo / Futuro

53 Montaje de Strut. Es probable reutilizar algunas partes del E.O.

AMORTIGUADORES Y STRUTS

Año	Notas de Aplicación										
		Ultra	ProGuard\ Guardian	LTV\ Max Control	Protector de Strut\ Bases de Strut	HiJacker\ Soporte\ Hidráulico	Ultra	ProGuard\ Guardian	LTV\ Max Control	Protector de Strut\ Bases de Strut	HiJacker\ Soporte\ Hidráulico

SEAT

SEAT

ALTEA

08-14	Con cilindro exterior de 55 mm	G56899	G51799
-------	--------------------------------	--------	------	------	------	------	--------	------	------	------	------

CORDOBA

03-09	Todos	G52048	70007
01-02	Todos	G35066	55991	G51735

FREETRACK

09-14	Todos	G56899
-------	-------	--------	------	------	------	------	------	------	------	------	------

IBIZA

08-16	Todos	G52585	70007
03-07	Todos	G52048	70007
99-02	Todos	G56999	G51735

LEON

08-11	Exc. Suspensión deportiva	G56899	G51799
01-07	Todos	G56606	69945

TOLEDO

13-17	Todos	70127
98-06	Todos	G56606	69945

STUDEBAKER

STUDEBAKER



AVANTI

63-64	Todos	82087	82103
-------	-------	------	-------	------	------	------	------	-------	------	------	------

CHAMPION

57-58	Todos	82087	82151
-------	-------	------	-------	------	------	------	------	-------	------	------	------



AMORTIGUADORES Y STRUTS

Año	Notas de Aplicación	Front					Rear				
			Ultra	ProGuard\ Guardian	LTV\ Max Control	Protector de Strut\ Bases de Strut	HiJacker\ Soporte\ Hidráulico		Ultra	ProGuard\ Guardian	LTV\ Max Control



STUDEBAKER

STUDEBAKER



COMMANDER

57-58	Todos		82087		82151
-------	-------	---	-------	-------	-------	-------	-------	---	-------	-------	-------	-------	-------



GOLDEN HAWK

57-58	Todos		82087		82151
-------	-------	---	-------	-------	-------	-------	-------	---	-------	-------	-------	-------	-------



HAWK

60-62	Todos		82087		82151
-------	-------	---	-------	-------	-------	-------	-------	---	-------	-------	-------	-------	-------



LARK



59-62	Todos		82087		82151
-------	-------	---	-------	-------	-------	-------	-------	---	-------	-------	-------	-------	-------

POWER HAWK



56	Todos		82026		82060
----	-------	---	-------	-------	-------	-------	-------	---	-------	-------	-------	-------	-------

PRESIDENT



57-58	Todos		82087		82151
-------	-------	---	-------	-------	-------	-------	-------	---	-------	-------	-------	-------	-------

55-56	Todos		82026		82060
-------	-------	---	-------	-------	-------	-------	-------	---	-------	-------	-------	-------	-------

SILVER HAWK

57-59	Todos		82087		82151
-------	-------	---	-------	-------	-------	-------	-------	---	-------	-------	-------	-------	-------





SKY HAWK

56	Todos		82026		82060
----	-------	--	-------	-------	-------	-------	-------	--	-------	-------	-------	-------	-------



SUBARU

SUBARU



B9 TRIBECA



06-07	Izquierdo		G52270		G51909
	Derecho		G52271		G51909

BAJA



03-06	Todos			G51767	143140 ⁹³
-------	-------	---	-------	-------	-------	-------	-------	---	--------	-------	-------	----------------------	-------



BRAT



82-87	Todos		G55726		69733	81450
-------	-------	---	--------	-------	-------	-------	-------	---	-------	-------	-------	-------	-------



80-81	Todos			69733	81450
-------	-------	---	-------	-------	-------	-------	-------	---	-------	-------	-------	-------	-------



DL



87-89	4WD; Exc. Hatchback, Sedan y Suspensión de Aire Izquierdo		G55785	
-------	---	---	--------	-------	-------	-------	-------	---	-------	-------	-------	-------	-------



	4WD; Exc. Hatchback, Sedan y Suspensión de Aire Derecho		G55784	
--	---	---	--------	-------	-------	-------	-------	---	-------	-------	-------	-------	-------

85-89	FWD, Sedan Exc. Suspensión de Aire			G51173
-------	------------------------------------	---	-------	-------	-------	-------	-------	---	--------	-------	-------	-------	-------



	FWD, Wagon Exc. Suspensión de Aire			G51183
--	------------------------------------	---	-------	-------	-------	-------	-------	---	--------	-------	-------	-------	-------

83-84	FWD		G55724		69733	81450
-------	-----	---	--------	-------	-------	-------	-------	---	-------	-------	-------	-------	-------

82-84	4WD		G55726		69733	81450
-------	-----	---	--------	-------	-------	-------	-------	---	-------	-------	-------	-------	-------



80-84	Todos			69733	81450
-------	-------	---	-------	-------	-------	-------	-------	---	-------	-------	-------	-------	-------

FORESTER

13	Todos		143492	
----	-------	---	-------	-------	-------	--------	-------	---	-------	-------	-------	-------	-------

53 Montaje de Strut. Es probable reutilizar algunas partes del E.O.

AMORTIGUADORES Y STRUTS

Año	Notas de Aplicación	From 					Rear 				
		Ultra	ProGuard\ Guardian	LTV\ Max Control	Protector de Strut\ Bases de Strut	HiJacker\ Soporte\ Hidráulico	Ultra	ProGuard\ Guardian	LTV\ Max Control	Protector de Strut\ Bases de Strut	HiJacker\ Soporte\ Hidráulico

SUBARU

SUBARU

FORESTER (cont)

09-12	Izquierdo	G52374	143492	G51961
	Derecho	G52375	143492	G51961
07-08	Izquierdo	G52180	143492	G52182
	Derecho	G52181	143492	G52183
06	Izquierdo	G52180	143492	G52182	143205 ⁵³
	Derecho	G52181	143492	G52183	143205 ⁵³
04-05	Izquierdo	G52067	143492	G52178	143205 ⁵³
	Derecho	G52068	143492	G52179	143205 ⁵³
03	Izquierdo	G52069	143492	G52178	143205 ⁵³
	Derecho	G52070	143492	G52179	143205 ⁵³
98-02	Izquierdo	G56544	142330 ⁵³ 143492
	Derecho	G56543	142330 ⁵³ 143492
	Exc. Sistema de Autonivelación NIVOMAT Izquierdo	G56546
	Exc. Sistema de Autonivelación NIVOMAT Derecho	G56545

GL

87-89	4WD; Exc. Hatchback, Sedan y Suspensión de Aire Izquierdo	G55785
	4WD; Exc. Hatchback, Sedan y Suspensión de Aire Derecho	G55784
85-89	4WD, Hatchback	G55726
	FWD, Hatchback	G55724
	FWD, Sedan Exc. Suspensión de Aire	G51173
	Hatchback	69733	81450
89	FWD, Wagon Exc. Suspensión de Aire	G51183
85-87	FWD, Wagon Exc. Suspensión de Aire	G51183
83-84	FWD	G55724	69733	81450
82-84	4WD	G55726	69733	81450
80-84	Todos	69733	81450

IMPREZA

08-13	Izquierdo	G52594	143492
	Derecho	G52595	143492
07	Todos	143492

53 Montaje de Strut. Es probable reutilizar algunas partes del E.O.

AMORTIGUADORES Y STRUTS

Año	Notas de Aplicación										
		Ultra	ProGuard\ Guardian	LTV\ Max Control	Protector de Strut\ Bases de Strut	HiJacker\ Soporte\ Hidráulico	Ultra	ProGuard\ Guardian	LTV\ Max Control	Protector de Strut\ Bases de Strut	HiJacker\ Soporte\ Hidráulico

SUBARU

SUBARU

IMPREZA (cont)

07	AWD, Wagon Izquierdo	143492	G52085
	AWD, Wagon Derecho	143492	G52086
	Sedan Izquierdo	G52087	143492
	Sedan Derecho	G52088	143492
	Wagon Izquierdo	G52083	143492
	Wagon Derecho	G52084	143492
04-06	Todos	143492	143205 ⁵³
	AWD, Wagon Izquierdo	143492	G52085	143205 ⁵³
	AWD, Wagon Derecho	143492	G52086	143205 ⁵³
	Sedan Izquierdo	G52087	143492	143205 ⁵³
	Sedan Derecho	G52088	143492	143205 ⁵³
	Wagon Izquierdo	G52083	143492	143205 ⁵³
	Wagon Derecho	G52084	143492	143205 ⁵³
04	AWD, Sedan Izquierdo	143492	G52089	143205 ⁵³
	AWD, Sedan Derecho	143492	G52090	143205 ⁵³
02-03	Izquierdo	143492	143466⁵³
	Derecho	143492	143466⁵³
	RS, Sedan Izquierdo	G52073
	RS, Sedan Derecho	G52074
	TS, Izquierdo	G52073
	TS, Derecho	G52074
	TS, Wagon Izquierdo	G52071
	Wagon Izquierdo	G52386
	Wagon Derecho	G52387
00-01	Outback, Izquierdo Sin ABS	143492	G56542
	Outback, Derecho Sin ABS	143492	G56541
98-01	L, AWD, Non-ABS Izquierdo	143492	G55930
	L, AWD, Non-ABS Derecho	143492	G55929
93-01	Todos	143492

53 Montaje de Strut. Es probable reutilizar algunas partes del E.O.

Texto en Negritas - Número de Parte Nuevo / Futuro

AMORTIGUADORES Y STRUTS

Año	Notas de Aplicación	Front					Rear				
		Ultra	ProGuard\ Guardian	LTV\ Max Control	Protector de Strut\ Bases de Strut	HiJacker\ Soporte\ Hidráulico	Ultra	ProGuard\ Guardian	LTV\ Max Control	Protector de Strut\ Bases de Strut	HiJacker\ Soporte\ Hidráulico

SUBARU

SUBARU

IMPREZA (cont)



93-01	Non-ABS Izquierdo	G55926	142330 ⁵³ 143492
	Non-ABS Derecho	G55925	142330 ⁵³ 143492
95-99	Outback, Non-ABS Izquierdo	143492	G56542
	Outback, Non-ABS Derecho	143492	G56541
96-97	Brighton, L, AWD, Non-ABS Izquierdo	143492	G55930
	Brighton, L, AWD, Non-ABS Derecho	143492	G55929
93-95	FWD, Non-ABS Izquierdo	143492	G55934
	FWD, Non-ABS Derecho	143492	G55933
95	Base, L, AWD, Non-ABS Izquierdo	143492	G55930
	Base, L, AWD, Non-ABS Derecho	143492	G55929
93-94	AWD, Non-ABS Izquierdo	143492	G55930
	AWD, Non-ABS Derecho	143492	G55929

LEGACY

10-13	Todos	143492
08-09	Izquierdo	G52023	143492	G51886
	Derecho	G52024	143492	G51886
05-07	Izquierdo	G52023	143492	G51886	143140 ⁵³
	Derecho	G52024	143492	G51886	143140 ⁵³
00-04	Izquierdo	G56556	142330 ⁵³ 143492	G56557	143140 ⁵³
	Derecho	G56555	142330 ⁵³ 143492	G56557	143140 ⁵³
95-99	Brighton, AWD, Izquierdo	142330 ⁵³ 143492	G55860
	Brighton, AWD, Derecho	142330 ⁵³ 143492	G55859
	Exc. Modelo Outback Izquierdo	G55858
	Exc. Modelo Outback Derecho	G55857
99	Outback, Outback Limited, Izquierdo	G55866	G55868
	Outback, Outback Limited, Derecho	G55865	G55867
98	Outback, Izquierdo	G55866	G55868
	Outback, Derecho	G55865	G55867
97	Outback, Outback Limited, Izquierdo	G55866	G55868

53 Montaje de Strut. Es probable reutilizar algunas partes del E.O.





































AMORTIGUADORES Y STRUTS

Año	Notas de Aplicación	Front					Rear				
			Ultra	ProGuard\ Guardian	LTV\ Max Control	Protector de Strut\ Bases de Strut	HiJacker\ Soporte\ Hidráulico		Ultra	ProGuard\ Guardian	LTV\ Max Control













SUBARU

SUBARU









LEGACY (cont)

97	Outback, Outback Limited, Derecho		G55865		G55867
95-96	L, FWD, Derecho			G56579
	Outback, Izquierdo		G55866		G55868
	Outback, Derecho		G55865		G55867
92-94	AWD, Coil(RearSpringType) Izquierdo		142330 ⁵³ 143492		G55930
	AWD, Coil(RearSpringType) Derecho		142330 ⁵³ 143492		G55929
	Coil(RearSpringType) Izquierdo		G55926	142330 ⁵³ 143492	
	Coil(RearSpringType) Derecho		G55925	142330 ⁵³ 143492	
	FWD, Coil(RearSpringType) Izquierdo		142330 ⁵³ 143492		G55934
	FWD, Coil(RearSpringType) Derecho		142330 ⁵³ 143492		G55933
90-94	Todos		142330 ⁵³ 143492	
90-91	Coil(FrontSpringType) Izquierdo		G55924	142330 ⁵³ 143492	
	Coil(FrontSpringType) Derecho		G55923	142330 ⁵³ 143492	
	FWD, Coil(RearSpringType) Izquierdo		142330 ⁵³ 143492		G55932
91	AWD, Coil(RearSpringType) Izquierdo		142330 ⁵³ 143492		G55928
	AWD, Coil(RearSpringType) Derecho		142330 ⁵³ 143492		G55927
90	AWD, Izquierdo Exc. Suspensión de Aire		142330 ⁵³ 143492		G55928
	AWD, Derecho Exc. Suspensión de Aire		142330 ⁵³ 143492		G55927

LOYALE

94	Exc. Suspensión de Aire			G51183
90-93	4WD, Izquierdo Exc. Suspensión de Aire		G55785	
	4WD, Derecho Exc. Suspensión de Aire		G55784	
	FWD, Sedan Exc. Suspensión de Aire			G51173
	Wagon Exc. Suspensión de Aire			G51183
90	FWD, Coupe Exc. Suspensión de Aire			G51173

OUTBACK

13	Todos		143492	
10-12	Izquierdo		G52272	143492	
	Derecho		G52273	143492	
06-09	Izquierdo		G52272	143492		G51910

53 Montaje de Strut. Es probable reutilizar algunas partes del E.O.

AMORTIGUADORES Y STRUTS

Año	Notas de Aplicación	From					Rear				
		Ultra	ProGuard\ Guardian	LTV\ Max Control	Protector de Strut\ Bases de Strut	HiJacker\ Soporte\ Hidráulico	Ultra	ProGuard\ Guardian	LTV\ Max Control	Protector de Strut\ Bases de Strut	HiJacker\ Soporte\ Hidráulico

SUBARU

SUBARU

OUTBACK (cont)

06-09	Derecho	G52273	143492	G51910
05	Izquierdo	G52272	143492	G51910	143140 ⁵³
	Derecho	G52273	143492	G51910	143140 ⁵³
00-04	AWD, Izquierdo	G56813	143492	G51767	143140 ⁵³
	AWD, Derecho	G56814	143492	G51767	143140 ⁵³

TRIBECA

08-13	Izquierdo	G52270	G51909
	Derecho	G52271	G51909

XT

85-91	FWD, Coil(RearSpringType) Exc. Suspensión de Aire	G51173
-------	---	------	------	------	------	------	--------	------	------	------	------

SUZUKI

SUZUKI

AERIO

04-07	Izquierdo	G52075	143401	G52021	143418
	Derecho	G52076	143401	G52022	143418
02-03	Izquierdo	G52019	143401	G52021	143418
	Derecho	G52020	143401	G52022	143418

EQUATOR

09-11	Todos	143379
-------	-------	------	------	------	--------	------	------	------	------	------	------

ESTEEM

95-02	Izquierdo	G56627	G56629
	Derecho	G56626	G56628

FORENZA

06-08	Izquierdo	G56882	143349 ⁵³	G56884	143350 ⁵³
	Derecho	G56883	143349 ⁵³	G56885	143350 ⁵³
04-05	Izquierdo	G56882	G56884
	Derecho	G56883	G56885

FORENZA READYMOUNTS

							Delantero	Trasero
04-08	Izquierdo						G57126 ⁴⁰	G57128 ⁴⁰
	Derecho						G57127 ⁴⁰	G57129 ⁴⁰

FORSA





85-88	Todos	G55749
-------	-------	--------	------	------	------	------	------	------	------	------	------

40 Strut ReadyMount. Ensamble Completo

53 Montaje de Strut. Es probable reutilizar algunas partes del E.O.

Texto en Negritas - Número de Parte Nuevo / Futuro





AMORTIGUADORES Y STRUTS

Año	Notas de Aplicación										
			Ultra	ProGuard\ Guardian	LTV\ Max Control	Protector de Strut\ Bases de Strut	HiJacker\ Soporte\ Hidráulico		Ultra	ProGuard\ Guardian	LTV\ Max Control





SUZUKI

SUZUKI

GRAND VITARA

13	Todos	
06-12	Izquierdo		G52184
	Derecho		G52185
99-05	Todos		143204 ⁵³	49613 ⁷
	Non-ABS		G56518	143204 ⁵³	49613 ⁷



RENO

06-08	Izquierdo		G56882	143349 ⁵³	143350 ⁵³
	Derecho		G56883	143349 ⁵³	143350 ⁵³
05	Izquierdo		G56882
	Derecho		G56883

RENO READYMOUNTS

		Delantero		Trasero	
05-08	Izquierdo	G57126 ⁴⁰		G57128 ⁴⁰	
	Derecho	G57127 ⁴⁰		G57129 ⁴⁰	





SAMURAI

86-95	Todos		G63798	61549 81675		G63949	61550 81676
-------	-------	---	--------	----------------	------	------	------	------	---	--------	----------------	------	------	------





SAMURAI ESTABILIZADORES DE DIRECCIÓN

		Delantero		Trasero	
86-95	Estabilizador de Dirección Sistema Sencillo	6802SE ⁸⁴		

SIDEKICK

96-98	Todos		49613 ⁷
	Non-ABS		G56518	142294 ⁵⁴	49613 ⁷
89-95	Todos		49613 ⁷
	Non-ABS		G56518	142294 ⁵⁴	49613 ⁷

SWIFT

06-11	Izquierdo		G52586		G511061
	Derecho		G52587		G511061

7 Paquetes en pares; kit de mangueras de aire incluido

53 Montaje de Strut. Es probable reutilizar algunas partes del E.O.



84 Amortiguador de repuesto para los vehículos con el kit de montaje aftermarket GRC

Texto en Negritas - Número de Parte Nuevo / Futuro

40 Strut ReadyMount. Ensamble Completo

54 Kit con Montaje y Rodamiento. Es probable que reutilizar algunas partes del E.O.

AMORTIGUADORES Y STRUTS

Año	Notas de Aplicación										
		Ultra	ProGuard\ Guardian	LTV\ Max Control	Protector de Strut\ Bases de Strut	HiJacker\ Soporte\ Hidráulico	Ultra	ProGuard\ Guardian	LTV\ Max Control	Protector de Strut\ Bases de Strut	HiJacker\ Soporte\ Hidráulico

SUZUKI

SUZUKI

SWIFT (cont)

89-01	Todos	G55891	142293 ⁵⁴	G55772	142295 ⁵³
-------	-------	--------	------	------	----------------------	------	--------	------	------	----------------------	------

VERONA

04-06	Izquierdo	G52359	G51997
	Derecho	G52390	G51998

VITARA

99-04	Todos	143204 ⁵³	G63799	61560 81904	49613 ⁷
	Non-ABS	G56518	143204 ⁵³	G63799	61560 81904	49613 ⁷

X-90

96-98	Todos	G63799	61560 81904	49613 ⁷
-------	-------	------	------	------	------	------	--------	----------------	------	------	--------------------

XL-7

07-09	Izquierdo	G52127	143469 ⁵³	G64015
	Derecho	G52128	143469 ⁵³	G64015
02-06	Todos	143204 ⁵³	G64105
	Sin ABS	G56518	143204 ⁵³	G64105

TOYOTA

TOYOTA

4RUNNER

13-16	Todos	143383 ⁵³	G63885
	Exc. Suspensión X-REAS; Exc. Modelo Deportivos	G51739	143383 ⁵³	G63885
03-12	Todos	143383 ⁵³
	Exc. Suspensión X-REAS	143383 ⁵³	G63885
	Exc. Suspensión X-REAS; Exc. Modelo Deportivos	G51739	143383 ⁵³
03	Limited	143383 ⁵³	G63885
96-02	Todos	G51077	G63726	77726	49387 ⁷
	Exc. HD	G51077	142838 ⁵³	G63726	77726	49387 ⁷
	HD	G51077	143325 ⁵³	G63726	77726	49387 ⁷



7 Paquetes en pares; kit de mangueras de aire incluido
53 Montaje de Strut. Es probable reutilizar algunas partes del E.O.

Texto en Negritas - Número de Parte Nuevo / Futuro

40 Strut ReadyMount. Ensamble Completo

54 Kit con Montaje y Rodamiento. Es probable que reutilizar algunas partes del E.O.

AMORTIGUADORES Y STRUTS

Año	Notas de Aplicación										
		Ultra	ProGuard\ Guardian	LTV\ Max Control	Protector de Strut\ Bases de Strut	HiJacker\ Soporte\ Hidráulico	Ultra	ProGuard\ Guardian	LTV\ Max Control	Protector de Strut\ Bases de Strut	HiJacker\ Soporte\ Hidráulico

TOYOTA

TOYOTA

4RUNNER (cont)

90-95	Todos	I O	G63547	61552 81870	77479	I O	G63548	61588 81906	77726	49388 ⁷
	Exc. HD	I O	G63547	61552 81870	77479	142838 ⁵³	I O	G63548	61588 81906	77726	49388 ⁷
86-89	Todos	I O	G63479	61552 81870	77479	O O	G63494	61510 81871	77494
84-85	Todos	I O	G63404	O O	G63494	61510 81871	77494

4RUNNER ESTABILIZADORES DE DIRECCIÓN

		Delantero	Trasero
84-85	Estabilizador de Dirección Sistema Sencillo	6803SE ⁸⁴

4RUNNER READYMOUNTS

		Delantero	Trasero
13-16	Izquierdo	G57133
	Derecho	G57134
03-12	Izquierdo	G57133³
	Derecho	G57134³
96-02	Izquierdo	G57065⁴⁰
	Derecho	G57066⁴⁰

AVALON

07-11	Izquierdo	I O	G56888	143402	I O	143413
	Izquierdo Fab. desde 1/06	I O	143402	I O	G52103
	Derecho	I O	G56889	143402	I O	143414
	Derecho Fab. desde 1/06	I O	143402	I O	G52104
06-11	Todos	I O	143402	I O
	Mount Kit w/ Strut Mount, Bearing & 3 Nuts	I O	143402	I O
06	Izquierdo	I O	G52365	143402	I O	G52367	143413
	Izquierdo Fab. desde 1/06	I O	G56888	143402	I O	G52103
	Derecho	I O	143402	I O	G52368	143414
	Derecho Fab. desde 1/06	I O	G56889	143402	I O	G52104
05	Izquierdo	I O	G52365	I O	G52367
	Derecho	I O	I O	G52368
97-04	Todos	I O	142556 ⁵⁸	I O	142837 ⁵³
04	Izquierdo	I O	G52376	142650 ⁵⁴ 142556 ⁵⁸	I O	G52412	142837 ⁵³
	Derecho	I O	G52377	142649 ⁵⁴ 142556 ⁵⁸	I O	G52413	142837 ⁵³
97-03	Izquierdo	I O	G56506	142650 ⁵⁴ 142556 ⁵⁸	I O	G55675	142837 ⁵³
	Derecho	I O	G56514	142649 ⁵⁴ 142556 ⁵⁸	I O	G55676	142837 ⁵³
95-96	Izquierdo	I O	G56502	142556 ⁵⁸ 142836 ⁵⁴	I O	G55675	142439 ⁵³

3 Número de parte futuro

40 Strut ReadyMount. Ensemble Completo

54 Kit con Montaje y Rodamiento. Es probable que reutilizar algunas partes del E.O.

84 Amortiguador de repuesto para los vehículos con el kit de montaje aftermarket GRC



Texto en Negritas - Número de Parte Nuevo / Futuro

7 Paquetes en pares; kit de mangueras de aire incluido

53 Montaje de Strut. Es probable reutilizar algunas partes del E.O.

58 El Kit de Montaje incluye: Rodamiento de Suspensión. Es probable reutilizar algunas partes del E.O.





AMORTIGUADORES Y STRUTS

Año	Notas de Aplicación										
		Ultra	ProGuard\ Guardian	LTV\ Max Control	Protector de Strut\ Bases de Strut	HiJacker\ Soporte\ Hidráulico	Ultra	ProGuard\ Guardian	LTV\ Max Control	Protector de Strut\ Bases de Strut	HiJacker\ Soporte\ Hidráulico

TOYOTA

TOYOTA





AVALON (cont)

95-96	Derecho		G56502	142556 ⁵⁸ 142836 ⁵⁴		G55676	142439 ⁵³
	Struts Reconstruibles de EO		G44783 ⁹⁸	





































AVALON READYMOUNTS

		Delantero		Trasero	
97-03	Izquierdo	G56930 ⁴⁰		G56932 ⁴⁰	
	Derecho	G56931 ⁴⁰		G56933 ⁴⁰	
95-96	Izquierdo		G56932 ⁴⁰	
	Derecho		G56933 ⁴⁰	

AVANZA

07-11	Izquierdo		G52344		70074
	Derecho		G52345		70074

CAMRY

14-15	Hybrid LE, Hybrid SE, Hybrid XLE, XLE, Izquierdo			G52736
	Hybrid LE, Hybrid SE, Hybrid XLE, XLE, Derecho			G52737
15	SE, Izquierdo		G52425	
	SE, Derecho		G52426	
14	SE, SE Sport, Izquierdo		G52425	
	SE, SE Sport, Derecho		G52426	
12-13	Exc. Modelos LE y L Izquierdo			G52485
	Exc. Modelos LE y L Derecho			G52486
	SE, Izquierdo		G52425	
	SE, Derecho		G52426	
07-11	Todos		143402	
	Izquierdo		G56888	143402		G52103	143413
	Derecho		G56889	143402		G52104	143414
04-06	Izquierdo		G56721	143202 ⁵³		G56728
	Derecho		G56722	143202 ⁵³		G56729
02-03	Izquierdo		G56673	143202 ⁵³		G56675	142837 ⁵³
	Derecho		G56674	143202 ⁵³		G56676	142837 ⁵³
97-01	Todos		142556 ⁵⁸		142837 ⁵³

40 Strut ReadyMount. Ensemble Completo

54 Kit con Montaje y Rodamiento. Es probable que reutilizar algunas partes del E.O.



53 Montaje de Strut. Es probable reutilizar algunas partes del E.O.

58 El Kit de Montaje incluye: Rodamiento de Suspensión. Es probable reutilizar algunas partes del E.O.

98 Nota: El nivel de dificultad para instalar este producto es moderadamente alto. Por favor revise las instrucciones cuidadosamente antes de comenzar.

Texto en Negritas - Número de Parte Nuevo / Futuro































AMORTIGUADORES Y STRUTS

Año	Notas de Aplicación	Front					Rear				
			Ultra	ProGuard\ Guardian	LTV\ Max Control	Protector de Strut\ Bases de Strut	HiJacker\ Soporte\ Hidráulico		Ultra	ProGuard\ Guardian	LTV\ Max Control

TOYOTA

TOYOTA









CAMRY (cont)

97-01	Izquierdo		G56506	142650 ⁵⁴ 142556 ⁵⁸		G55675	142837 ⁵³
	Derecho		G56514	142649 ⁵⁴ 142556 ⁵⁸		G55676	142837 ⁵³
95-96	Izquierdo		G56502	142556 ⁵⁸ 142836 ⁵⁴		G55675	142439 ⁵³
	Derecho		G56502	142556 ⁵⁸ 142836 ⁵⁴		G55676	142439 ⁵³
	Struts Reconstruibles de EO		G44783 ⁹⁸	
92-94	Todos			142439 ⁵³
	Izquierdo Struts Sellados de EO			G55675	142439 ⁵³
	Derecho Struts Sellados de EO			G55676	142439 ⁵³
	Struts Sellados de EO		G55914		142439 ⁵³
	FWD, Struts Reconstruibles de EO		G44999 ⁹⁸		G44477 ⁹⁸	142439 ⁵³
87-91	Todos		G55590	143278 ⁵³	
	Struts Delanteros Reconstruibles de EO		G44982 ⁹⁸	143278 ⁵³	
	FWD		G55590	143278 ⁵³		G55589
	Wagon		G55590	143278 ⁵³		G55588
83-86	Todos		G44940 ⁹⁸		

CAMRY READYMOUNTS

		Delantero	Trasero
04-06	Izquierdo	G57078 ⁴⁰
	Derecho	G57079 ⁴⁰
	4 Cyl Izquierdo	G57076 ⁴⁰
	4 Cyl Derecho	G57077 ⁴⁰
02-03	Izquierdo	G57041 ⁴⁰	G57043 ⁴⁰
	Derecho	G57042 ⁴⁰	G57044 ⁴⁰
97-01	Izquierdo	G56930 ⁴⁰	G56932 ⁴⁰
	Derecho	G56931 ⁴⁰	G56933 ⁴⁰
95-96	Izquierdo	G56942 ⁴⁰	G56932 ⁴⁰
	Derecho	G56942 ⁴⁰	G56933 ⁴⁰
92-94	Izquierdo Struts Sellados de EO	G56932 ⁴⁰
	Derecho Struts Sellados de EO	G56933 ⁴⁰

CELICA

00-05	Izquierdo		G56586	143201 ⁵³		G56587	143094 ⁵³
	Derecho		G56585	143201 ⁵³		G56587	143094 ⁵³
94-99	Izquierdo		G56573	142556 ⁵⁸		G56575
	Derecho		G56576	142556 ⁵⁸		G56574

40 Strut ReadyMount. Ensemble Completo

54 Kit con Montaje y Rodamiento. Es probable que reutilizar algunas partes del E.O.

98 Nota: El nivel de dificultad para instalar este producto es moderadamente alto. Por favor revise las instrucciones cuidadosamente antes de comenzar.

53 Montaje de Strut. Es probable reutilizar algunas partes del E.O.

58 El Kit de Montaje incluye: Rodamiento de Suspensión. Es probable reutilizar algunas partes del E.O.

Texto en Negritas - Número de Parte Nuevo / Futuro

AMORTIGUADORES Y STRUTS

Año	Notas de Aplicación	Front					Rear				
		Ultra	ProGuard\ Guardian	LTV\ Max Control	Protector de Strut\ Bases de Strut	HiJacker\ Soporte\ Hidráulico	Ultra	ProGuard\ Guardian	LTV\ Max Control	Protector de Strut\ Bases de Strut	HiJacker\ Soporte\ Hidráulico

TOYOTA

TOYOTA

CELICA (cont)

92-93	FWD	↓	G55606
	GT, GTS, ST	G44995 ⁹⁸	↓
90-91	Todos	G44995 ⁹⁸	↓
	FWD	G44995 ⁹⁸	↓	G55606
88-89	AWD	G44939 ⁹⁸	↓
	FWD; Exc. All-Trac	G44982 ⁹⁸	↓
	GT, GTS, ST	↓	142249 ⁵³
86-87	Todos	↓	G55529	142249 ⁵³
	Exc. All-Trac	G44939 ⁹⁸	↓	G55529	142249 ⁵³
82-85	Todos	G44938 ⁹⁸	↓	69713	81416
78-81	Todos	G44938 ⁹⁸	↓	81416
76-77	Todos	G44938 ⁹⁸	↓
75	Fab. hasta 10/75	G44938 ⁹⁸	↓



COROLLA

14-16	Todos	↓	G51898
09-13	Izquierdo	G52245	↓	G51898
	Derecho	G52246	↓	G51898
03-08	Izquierdo	G56661	143201 ⁵³	↓	G51736	143094 ⁵³
	Derecho	G56660	143201 ⁵³	↓	G51736	143094 ⁵³
97-02	LE	143281 ⁵³	↓
93-02	Izquierdo	G55999	↓	G55661
	Derecho	G55999	↓	G55662
88-02	Exc. Wagon Derecho	↓	142229 ⁵³
93-97	Exc. Modelo LE	143280 ⁵³	↓
93-95	LE	143281 ⁵³	↓
88-92	Exc. Wagon	G55591	↓	G55557
92	DLX, DLX All Trac, LE, SR5	143281 ⁵³	↓
88-91	DLX, DLX All Trac, GTS, LE, SR5	143281 ⁵³	↓
	Wagon	G44994 ⁹⁸	↓	81498

53 Montaje de Strut. Es probable reutilizar algunas partes del E.O.

98 Nota: El nivel de dificultad para instalar este producto es moderadamente alto. Por favor revise las instrucciones cuidadosamente antes de comenzar.













AMORTIGUADORES Y STRUTS

Año	Notas de Aplicación	Front					Rear				
			Ultra	ProGuard\ Guardian	LTV\ Max Control	Protector de Strut\ Bases de Strut	HiJacker\ Soporte\ Hidráulico		Ultra	ProGuard\ Guardian	LTV\ Max Control

TOYOTA

TOYOTA

COROLLA (cont)

88	FX16, Hatchback Struts Delanteros Reconstruibles		G44939 ⁹⁸
86-87	FWD		G55752	142249 ⁹³
	FWD, Struts Delanteros Sellados		G55715	142249 ⁹³
84-87	Todos		142249 ⁹³
	Coupe		81498	142249 ⁹³
	Rack(SteeringType), Coupe, Standard		G44938 ⁹⁸	142249 ⁹³
87	FWD, Exc. Struts Delanteros Reconstruibles FX16		G44747 ⁹⁸	142249 ⁹³
	FX16, Hatchback Struts Delanteros Reconstruibles		G44939 ⁹⁸	142249 ⁹³
86	FWD, Struts Delanteros Reconstruibles		G44747 ⁹⁸	142249 ⁹³
84-85	FWD, DIESEL		G44939 ⁹⁸	142249 ⁹³
	FWD, GAS		G55752	142249 ⁹³
	FWD, GAS Struts Delanteros Reconstruibles		G44747 ⁹⁸	142249 ⁹³
	FWD, GAS Struts Delanteros Sellados		G55715	142249 ⁹³
80-83	Coupe		G44938 ⁹⁸	81498
	Hatchback		G44938 ⁹⁸	81498
	Sedan		G44938 ⁹⁸	81498
75-83	Todos		G44938 ⁹⁸
	Wagon		G44938 ⁹⁸	81416
83	Hardtop		G44938 ⁹⁸	81498
76-79	Coupe		G44938 ⁹⁸	81340
75-79	Sedan		G44938 ⁹⁸	81340
75-78	Hardtop		G44938 ⁹⁸	81340
72-74	Coupe		81340
	Sedan		81340
71-74	Wagon		82020
74	Fab. desde 8/74		G44938 ⁹⁸
	Wagon Fab. desde 8/74		81416

COROLLA READYMOUNTS

		Delantero	Trasero
03-08	Izquierdo	G57114 ⁴⁰	G57067 ⁴⁰
	Derecho	G57115 ⁴⁰	G57068 ⁴⁰
98-02	Izquierdo	G56948 ⁴⁰	G56949 ⁴⁰

40 Strut ReadyMount. Ensemble Completo

53 Montaje de Strut. Es probable reutilizar algunas partes del E.O.

98 Nota: El nivel de dificultad para instalar este producto es moderadamente alto. Por favor revise las instrucciones cuidadosamente antes de comenzar.

Texto en Negritas - Número de Parte Nuevo / Futuro

AMORTIGUADORES Y STRUTS

Año	Notas de Aplicación	Front					Rear				
		Ultra	ProGuard\ Guardian	LTV\ Max Control	Protector de Strut\ Bases de Strut	HiJacker\ Soporte\ Hidráulico	Ultra	ProGuard\ Guardian	LTV\ Max Control	Protector de Strut\ Bases de Strut	HiJacker\ Soporte\ Hidráulico

TOYOTA

TOYOTA

COROLLA READYMOUNTS (cont)

		Delantero	Trasero
98-02	Derecho	G56948 ⁴⁰	G56950 ⁴⁰
93-97	Izquierdo	G56947 ⁴⁰	G56949 ⁴⁰
	Derecho	G56947 ⁴⁰	G56950 ⁴⁰

CORONA

79-82	Todos	G44898 ⁹⁸
	Exc. Wagon	G44898 ⁹⁸
79-81	Wagon	G44898 ⁹⁸
77-78	Wagon	81494	49310 ⁷
73-78	Fabricado desde 8/73	69600	81494
69-78	Todos	81494
75-76	Wagon	81494
74-76	Exc. Wagon	81494	49151 ⁷
74	Wagon Wagon	81494
73	Exc. Wagon	81494	49151 ⁷
	Wagon Fabricado desde 8/73	81494
69-72	Mark II	69600	81494
72	Exc. Wagon	81494
69-71	Exc. Wagon	81494
	Mark II, Sedan	81494	49151 ⁷
	Mark II, Wagon	81494	49309 ⁷
68	Exc. Wagon

CRESSIDA

89-92	Exc. Suspensión Electrónica Ajustable	G44926 ⁹⁸	142437 ⁵³	G51060
85-88	Exc. Suspensión Electrónica Ajustable	G44926 ⁹⁸	142437 ⁵³
	Sedan Exc. Suspensión Electrónica Ajustable	81440
81-87	Wagon	81416
83-84	Exc. Suspensión Electrónica Ajustable	G44926 ⁹⁸
	Sedan	81440
81-82	Exc. Suspensión Electrónica Ajustable	G44926 ⁹⁸	14224 ⁵³
	Sedan Exc. Suspensión Electrónica Ajustable	81440
78-80	Todos	G44898 ⁹⁸	14224 ⁵³
	Sedan	G44898 ⁹⁸	14224 ⁵³	81440
	Wagon	G44898 ⁹⁸	14224 ⁵³	81340





7 Paquetes en pares; kit de mangueras de aire incluido
53 Montaje de Strut. Es probable reutilizar algunas partes del E.O.

40 Strut ReadyMount. Ensamble Completo

98 Nota: El nivel de dificultad para instalar este producto es moderadamente alto. Por favor revise las instrucciones cuidadosamente antes de comenzar.

Texto en Negritas - Número de Parte Nuevo / Futuro







AMORTIGUADORES Y STRUTS

Año	Notas de Aplicación										
			Ultra	ProGuard\ Guardian	LTV\ Max Control	Protector de Strut\ Bases de Strut	HiJacker\ Soporte\ Hidráulico		Ultra	ProGuard\ Guardian	LTV\ Max Control







TOYOTA

TOYOTA









CROWN

67	Fabricado antes de Sep/67		82099	
65-66	Todos		82099	
	Wagon		82099		82156

ECHO

00-05	Todos		G56572		69450
	Sólo aplica para Número de EO 48609-52011 y 48609-52050		G56572	143194 ⁵³		69450
	Sólo aplica para Número de EO 48609-52021		G56572	143195 ⁵³		69450



FJ CRUISER

11-12	4WD		G51739	143383 ⁵³		G64030
07-12	Todos		G51739	143383 ⁵³	
	RWD		G51739	143383 ⁵³		G64029
07-09	4WD		G51739	143383 ⁵³		G64030























FJ CRUISER READYMOUNTS

							Delantero	Trasero
12	Izquierdo						G57133 ⁴⁰
	Derecho						G57134 ⁴⁰
07-11	Izquierdo						G57133 ³
	Derecho						G57134 ³

HIACE

06-16	Todos		G64058		G64059
-------	-------	---	--------	------	------	------	------	---	--------	------	------	------	------

HIGHLANDER

11-13	Izquierdo		G52201	143402		143509 ⁵³
	Derecho		G52202	143402		143510 ⁵³
	AWD, Izquierdo			G52380
	AWD, Derecho			G52381
	FWD, Izquierdo			G52203
	FWD, Derecho			G52204
08-10	Todos		143402	
	Izquierdo		G52201	143402	
	Derecho		G52202	143402	
	AWD, Izquierdo		143402		G52380
	AWD, Derecho		143402		G52381



3 Número de parte futuro

40 Strut ReadyMount. Ensamble Completo

53 Montaje de Strut. Es probable reutilizar algunas partes del E.O.

Texto en Negritas - Número de Parte Nuevo / Futuro

AMORTIGUADORES Y STRUTS

Año	Notas de Aplicación										
		Ultra	ProGuard\ Guardian	LTV\ Max Control	Protector de Strut\ Bases de Strut	HiJacker\ Soporte\ Hidráulico	Ultra	ProGuard\ Guardian	LTV\ Max Control	Protector de Strut\ Bases de Strut	HiJacker\ Soporte\ Hidráulico

TOYOTA

TOYOTA

HIGHLANDER (cont)

08-10	FWD, Izquierdo	↓	143402	↓	G52203
	FWD, Derecho	↓	143402	↓	G52204
04-07	Izquierdo	↓	G56730	143202 ⁵³	↓	143387
	Derecho	↓	G56731	143202 ⁵³	↓	143388
	AWD, Izquierdo	↓	↓	G56732 G56734
	AWD, Derecho	↓	↓	G56733
	FWD, Derecho	↓	↓	G56735
			↓	↓
01-03	Izquierdo	↓	G56679	143202 ⁵³	↓
	Derecho	↓	G56680	143202 ⁵³	↓
	AWD, Izquierdo	↓	↓	G56681
	AWD, Derecho	↓	↓	G56682
	FWD, Izquierdo	↓	↓	G56667
	FWD, Derecho	↓	↓	G56668

HILUX

06-15	Todos	↓	G51894	↓	G64057
-------	-------	---	--------	------	------	------	------	---	--------	------	------	------	------



LAND CRUISER

98-07	Todos	↓	G63832	↓	G63828
93-97	Todos	↓	G63615	↓	G63616
91-92	Todos	↓	G63615	↓
	FJ80(Cdigo plataforma del fabricante)	↓	G63615	↓	G63616
88-90	Todos	↓	G63432	61507	↓	G63510
84-87	Todos	↓	↓	49311 ⁷
81-87	Sport Utility, FJ60(Cdigo plataforma del fabricante)	↓	G63432	61507	↓	G63492	61506 81318	77492	49311 ⁷
81-83	Todos	↓	↓	G63492	61506 81318	77492	49311 ⁷
	FJ40(Cdigo plataforma del fabricante)	↓	G63299	82007	↓	G63492	61506 81318	77492	49311 ⁷
80	Todos	↓	61507	↓	G63492	61506 81318	77492	49311 ⁷
	FJ40(Cdigo plataforma del fabricante)	↓	G63299	82007 61507	↓	G63492	61506 81318	77492	49311 ⁷
76-79	FJ40(Cdigo plataforma del fabricante)	↓	G63299	82007	↓	G63492	61506 81318	77492	49311 ⁷
	Sport Utility, FJ55(Cdigo plataforma del fabricante)	↓	81340	↓	G63492	61506 81318	77492	49311 ⁷
79	Todos	↓	↓	G63492	81318	77492	49311 ⁷
76-78	Todos	↓	↓	G63492	61506 81318	77492	49311 ⁷
75	Todos	↓	↓	81318
	Fab. desde 1/75	↓	↓	G63492	81318	49311 ⁷

7 Paquetes en pares; kit de mangueras de aire incluido

53 Montaje de Strut. Es probable reutilizar algunas partes del E.O.









AMORTIGUADORES Y STRUTS

Año	Notas de Aplicación	Front					Rear				
			Ultra	ProGuard\ Guardian	LTV\ Max Control	Protector de Strut\ Bases de Strut	HiJacker\ Soporte\ Hidráulico		Ultra	ProGuard\ Guardian	LTV\ Max Control

TOYOTA

TOYOTA







LAND CRUISER (cont)

75	Fab. hasta 2/75	
	FJ40(Cdigo plataforma del fabricante) Fab. desde 1/75	
	FJ40(Cdigo plataforma del fabricante) Fab. hasta 2/75		G63299	82007
	Sport Utility, FJ55(Cdigo plataforma del fabricante)		81340
	Sport Utility, FJ55(Cdigo plataforma del fabricante) Fab. desde 1/75	
69-74	Todos		G63299	81340 82007	G63492	77492
	Exc. Wagon		G63299	81340 82007	G63492	61500	77492	49310 ⁷
	Wagon		G63299	81340 82007	G63492	81318	77492	49311 ⁷
67-68	Todos		G63299	82007	61500 81147	49310 ⁷

LAND CRUISER ESTABILIZADORES DE DIRECCIÓN

		Delantero	Trasero
80-95	Todos	14073







MATRIX

09-13	Izquierdo		G52245	
	Derecho		G52246	
09-11	FWD		G51898	
03-08	Izquierdo		G52013	143093 ⁵³	143094 ⁵³
	Derecho		G52014	143093 ⁵³	143094 ⁵³
	FWD		G51736	
03-06	AWD		G51768	

MATRIX READYMOUNTS

		Delantero	Trasero
03-08	FWD, Izquierdo	G57067 ⁴⁰
	FWD, Derecho	G57068 ⁴⁰

MR2

00-05	Izquierdo		G52624
	Izquierdo		G52393
	Derecho		G52625
	Derecho		G52394
92-95	Todos		G44998 ⁹⁸	G44997 ⁹⁸
87-89	Todos		G44802 ⁹⁸	G44943 ⁹⁸
85-86	Todos		G44802 ⁹⁸	G44803 ⁹⁸

7 Paquetes en pares; kit de mangueras de aire incluido
53 Montaje de Strut. Es probable reutilizar algunas partes del E.O.

40 Strut ReadyMount. Ensamble Completo

98 Nota: El nivel de dificultad para instalar este producto es moderadamente alto. Por favor revise las instrucciones cuidadosamente antes de comenzar.

Texto en Negritas - Número de Parte Nuevo / Futuro

AMORTIGUADORES Y STRUTS

Año	Notas de Aplicación	From					Rear				
		Ultra	ProGuard\ Guardian	LTV\ Max Control	Protector de Strut\ Bases de Strut	HiJacker\ Soporte\ Hidráulico	Ultra	ProGuard\ Guardian	LTV\ Max Control	Protector de Strut\ Bases de Strut	HiJacker\ Soporte\ Hidráulico

TOYOTA

TOYOTA

PASEO

95-99	Todos	G55879	142307 ⁵³	G51252
92-94	Todos	G55828	142307 ⁵³	G55804

PICKUP

93-95	RWD, Exc. 1 Ton	G63903	61509 81541	77903	G63907	61500 81147	77907	49310 ⁷
86-95	4WD, Exc. Kit de Levantamiento	G63479	61552 81870	77479	G63494	61510 81871	77494
85-95	RWD	43048 ⁸
	RWD Exc. 1 Ton	70163
85-92	RWD, 1 Ton	61509	G63492	61506 81318	77492	49311 ⁷
	RWD, Exc. 1 Ton	G63903	81541	77903	G63907	61500 81147	77907	49310 ⁷
84-85	4WD, Exc. Kit de Levantamiento	G63404	G63494	61510 81871	77494
84	RWD	G63903	61509 81541	77903	G63907	81147	77907	43048 ⁸ 49310 ⁷ 70163
	RWD; Mojave	61500
80-83	4WD, Exc. Kit de Levantamiento	G63404	G63492	61506 81318	77492	49311 ⁷
	4WD, Kit de Levantamiento de 2-3"	G63444 ⁵⁰	G63440 ⁵⁰
75-83	RWD; Mojave	70163
	RWD, Mojave	81750	G63907	81147	77907	43048 ⁸ 49151 ⁷
70-83	RWD; Mojave	61504	61500
73-74	RWD; Mojave	43048 ⁸ 70163
	RWD, Mojave	81750	G63907	81147	77907	49151 ⁷
70-72	RWD	43048 ⁸
	RWD; Mojave	70163
	RWD	49151 ⁷
	RWD, Mojave	81750	G63907	81147	77907

PICKUP ESTABILIZADORES DE DIRECCIÓN

		Delantero	Trasero
86-95	Estabilizador de Dirección Sistema Sencillo	6802SE ⁸⁴
	4WD, Estabilizador de Dirección Sistema Sencillo c/ Montajes de EO	6804SE ⁸⁰
80-85	4WD, Estabilizador de Dirección Sistema Sencillo c/ Montajes de EO	6803SE ⁸⁴
79-85	RWD, Estabilizador de Dirección Sistema Sencillo	6802SE ⁸⁴

PREVIA

91-97	Izquierdo	G55652	143278 ⁵³	G63620	61594
	Derecho	G55653	143278 ⁵³	G63620	61594

PRIUS

13	Ruedas de 17"	G70053
----	---------------	------	------	------	------	------	--------	------	------	------	------

7 Paquetes en pares; kit de mangueras de aire incluido

8 Paquetes en pares



50 Para proteger la barra del pistón, se recomienda utilizar el kit Bellows No.141242.

53 Montaje de Strut. Es probable reutilizar algunas partes del E.O.

80 No requiere soportes para el montaje, instalar sobre montajes de EO Vea Ref. C para Botas.

84 Amortiguador de repuesto para los vehículos con el kit de montaje aftermarket GRC

AMORTIGUADORES Y STRUTS

Año	Notas de Aplicación										
		Ultra	ProGuard\ Guardian	LTV\ Max Control	Protector de Strut\ Bases de Strut	HiJacker\ Soporte\ Hidráulico	Ultra	ProGuard\ Guardian	LTV\ Max Control	Protector de Strut\ Bases de Strut	HiJacker\ Soporte\ Hidráulico

TOYOTA

TOYOTA

PRIUS (cont)

10-12	Todos	143553 ⁵³	143554 ⁵³
	Izquierdo Fab. hasta 12/2011	G52331	143553 ⁵³	143554 ⁵³
	Derecho Fab. hasta 12/2011	G52332	143553 ⁵³	143554 ⁵³
	Ruedas de 17"	143553 ⁵³	70053	143554 ⁵³
04-09	Izquierdo	G56890	143201 ⁵³	G51795	143094 ⁵³
	Derecho	G56891	143201 ⁵³	G51795	143094 ⁵³
01-03	Izquierdo	G52077	143193 ⁵³	G51840	143094 ⁵³
	Derecho	G52078	143193 ⁵³	G51840	143094 ⁵³

PRIUS C

12-14	Todos	70055
-------	-------	-------	-------	-------	-------	-------	-------	-------	-------	-------

RAV4

06-12	Izquierdo	G52004	G64026
	Derecho	G52007	G64026
	4WD	143343
01-05	Izquierdo	G56582	143367 ³	69813 G63860
	Derecho	G56581	143367 ³	69813 G63860
00	Todos	143367 ³	G63860
	Fab. hasta 5/00	143367 ³	G63860	61651
	Fabricado desde May/00	143367 ³	69813 G63860
	Izquierdo Fab. desde 5/00	G56582	143367 ³	G63860
	Izquierdo Struts Sellados fabricados en Abr/00	G56631	143367 ³	G63860
	Derecho Fab. desde 5/00	G56581	143367 ³	G63860
	Derecho Struts Sellados fabricados en Abr/00	G56632	143367 ³	G63860
96-99	Todos	143367 ³	G63860	61651
	Izquierdo Struts Sellados	G56631	143367 ³	G63860	61651
	Derecho Struts Sellados	G56632	143367 ³	G63860	61651

RAV4 READYMOUNTS

		Delantero	Trasero
06-08	Izquierdo	G57204 ⁴⁰
	Derecho	G57205 ⁴⁰
00-05	AWD, Automatic Izquierdo Fabricado desde May/00	G57105 ⁴⁰
	AWD, Automatic Derecho Fabricado desde May/00	G57106 ⁴⁰

3 Número de parte futuro

40 Strut ReadyMount. Ensamble Completo

53 Montaje de Strut. Es probable reutilizar algunas partes del E.O.

Texto en Negritas - Número de Parte Nuevo / Futuro

AMORTIGUADORES Y STRUTS

Año	Notas de Aplicación	Front					Rear				
		Ultra	ProGuard\ Guardian	LTV\ Max Control	Protector de Strut\ Bases de Strut	HiJacker\ Soporte\ Hidráulico	Ultra	ProGuard\ Guardian	LTV\ Max Control	Protector de Strut\ Bases de Strut	HiJacker\ Soporte\ Hidráulico

TOYOTA

TOYOTA

SEQUOIA

16	Todos	G51937
12-15	Todos	G51937	143339 ⁵³
08-11	Todos	G51937	G64077
	Todos	G51937	143339 ⁵³	G64077	143340 ⁵³
01-07	Todos	G51477	143325 ⁵³	G64087

SEQUOIA READYMOUNTS

							Delantero	Trasero
01-07	Todos						G57027⁴⁰

SIENNA

09-16	Todos	143338 ⁵³
09-10	AWD, Izquierdo	G52105	G51805	143338 ⁵³
	AWD, Derecho	G52106	G51805	143338 ⁵³
	FWD, 7 Pasajeros	G51804	143338 ⁵³
	FWD, 8 Pasajeros	G51805	143338 ⁵³
	FWD, Izquierdo 8 Pasajeros	G52105	143338 ⁵³
	FWD, Izquierdo Fab. desde 7/05, 7 Pasajeros	G52107	143338 ⁵³
	FWD, Derecho 8 Pasajeros	G52106	143338 ⁵³
	FWD, Derecho Fab. desde 7/05, 7 Pasajeros	G52108	143338 ⁵³
06-08	AWD, Izquierdo	G52105	143202 ⁵³	G51805	143338 ⁵³
	AWD, Derecho	G52106	143202 ⁵³	G51805	143338 ⁵³
	FWD, Izquierdo 8 Pasajeros	G52105	143202 ⁵³	143338 ⁵³
	FWD, Derecho 8 Pasajeros	G52106	143202 ⁵³	143338 ⁵³
05-08	FWD, Izquierdo Fab. desde 7/05, 7 Pasajeros	G52107	143202 ⁵³	143338 ⁵³
	FWD, Derecho Fab. desde 7/05, 7 Pasajeros	G52108	143202 ⁵³	143338 ⁵³
04-08	Todos	143202 ⁵³	143338 ⁵³
	FWD, 7 Pasajeros	143202 ⁵³	G51804	143338 ⁵³
	FWD, 8 Pasajeros	143202 ⁵³	G51805	143338 ⁵³
04-05	AWD	143202 ⁵³	G51805	143338 ⁵³
05	AWD, Izquierdo Fab. desde 7/05	G52105	143202 ⁵³	143338 ⁵³
	AWD, Derecho Fab. desde 7/05	G52106	143202 ⁵³	143338 ⁵³
	FWD, Izquierdo Fab. desde 7/05, 8 Pasajeros	G52105	143202 ⁵³	143338 ⁵³

40 Strut ReadyMount. Ensamble Completo

53 Montaje de Strut. Es probable reutilizar algunas partes del E.O.

Texto en Negritas - Número de Parte Nuevo / Futuro

AMORTIGUADORES Y STRUTS

Año	Notas de Aplicación	Front					Rear				
		Ultra	ProGuard\ Guardian	LTV\ Max Control	Protector de Strut\ Bases de Strut	HiJacker\ Soporte\ Hidráulico	Ultra	ProGuard\ Guardian	LTV\ Max Control	Protector de Strut\ Bases de Strut	HiJacker\ Soporte\ Hidráulico

TOYOTA

TOYOTA

SIENNA (cont)

05	FWD, Izquierdo Fab. hasta 6/05; 7 Pasajeros	G56798	143202 ⁵³	143338 ⁵³	
	FWD, Derecho Fab. desde 7/05; 8 Pasajeros	G52106	143202 ⁵³	143338 ⁵³	
	FWD, Derecho Fab. hasta 6/05; 7 Pasajeros	G56797	143202 ⁵³	143338 ⁵³	
04	FWD, Izquierdo 7 Pasajeros	G56798	143202 ⁵³	143338 ⁵³	
	FWD, Derecho 7 Pasajeros	G56797	143202 ⁵³	143338 ⁵³	
98-03	Izquierdo	G55993	142650 ⁵⁴	I/O	G63610	61592 81937
	Derecho	G55994	I/O	G63610	61592 81937
	Fab. hasta 12/02 Derecho	142649 ⁵⁴

SIENNA READYMOUNTS

		Delantero	Trasero
03	Fab. hasta 12/02 Izquierdo	G57097 ⁴⁰
	Fab. hasta 12/02 Derecho	G57098 ⁴⁰
02	Fabricado antes de Dic/02 Izquierdo	G57097 ⁴⁰
	Fabricado antes de Dic/02 Derecho	G57098 ⁴⁰
98-01	Fab. hasta 12/02 Izquierdo	G57097 ⁴⁰
	Fab. hasta 12/02 Derecho	G57098 ⁴⁰

SOLARA

07	Todos	143202 ⁵³
04-06	Izquierdo	G56721	143202 ⁵³	G56728
	Derecho	G56722	143202 ⁵³	G56729
99-03	Izquierdo	G56506	142650 ⁵⁴	G55675	142837 ⁵³
	Derecho	G56514	142649 ⁵⁴	G55676	142837 ⁵³

SOLARA READYMOUNTS

		Delantero	Trasero
04-06	Izquierdo	G57076 ⁴⁰	G57078 ⁴⁰
	Derecho	G57077 ⁴⁰	G57079 ⁴⁰
99-03	Izquierdo	G56930 ⁴⁰	G56932 ⁴⁰
	Derecho	G56931 ⁴⁰	G56933 ⁴⁰

STARLET

81-84	Todos	G44724 ⁹³	I/O	81440
-------	-------	----------------------	------	------	------	------	-----	------	-------	------	------	------

SUPRA

87-91	Exc. Suspensión Electrónica Ajustable	G51197 ⁹	G51193 ⁹
86	Exc. Suspensión Electrónica Ajustable	G51197 ⁹
	Fab. desde 3/86; Exc. Suspensión Electrónica Ajustable	G51193 ⁹

9 Vea Ref.D para los procedimientos de reemplazo de una Susp. Elect. Ajust. con un producto no ajust.

53 Montaje de Strut. Es probable reutilizar algunas partes del E.O.

98 Nota: El nivel de dificultad para instalar este producto es moderadamente alto. Por favor revise las instrucciones cuidadosamente antes de comenzar.

Texto en Negritas - Número de Parte Nuevo / Futuro

40 Strut ReadyMount. Ensamble Completo

54 Kit con Montaje y Rodamiento. Es probable que reutilizar algunas partes del E.O.

AMORTIGUADORES Y STRUTS

Año	Notas de Aplicación	From					Rear				
		Ultra	ProGuard\ Guardian	LTV\ Max Control	Protector de Strut\ Bases de Strut	HiJacker\ Soporte\ Hidráulico	Ultra	ProGuard\ Guardian	LTV\ Max Control	Protector de Strut\ Bases de Strut	HiJacker\ Soporte\ Hidráulico

TOYOTA

TOYOTA

SUPRA (cont)

86	Fab. hasta 3/86	G44938 ⁹⁸	142437 ⁵³	69713
----	-----------------	----------------------	------	------	----------------------	------	-------	------	------	------	------

T100

93-98	4WD	G63479	61552 81870	77479	G63660	61582
	RWD	G63903	61509 81541	77903	G63173	61506	77492

TACOMA



13	4WD	G51739
	Base, RWD	G63889
	Pre Runner	G51739
10-12	X-Runner, Izquierdo	G51739	143383 ⁵³	G64004
	X-Runner, Derecho	G51739	143383 ⁵³	G64005
05-12	Todos	143383 ⁵³
	4WD	G51739	143383 ⁵³	G64006
	Base, RWD	143383 ⁵³	G63889
	Pre Runner	G51739	143383 ⁵³	G64007
05-09	Modelos Base y X-Runner Izquierdo	G51853	143383 ⁵³
	Modelos Base y X-Runner Derecho	G51854	143383 ⁵³
	RWD; Base; Exc. Offroad Package	143383 ⁵³	61719
	RWD; Pre Runner	143383 ⁵³	61706
	X-Runner, Izquierdo	143383 ⁵³	G64004
	X-Runner, Derecho	143383 ⁵³	G64005
05-06	4WD	143383 ⁵³	61705
01-04	S-Runner	G63937	G63689	61510
	S-Runner, Exc. Offroad Package	G51868	61606 81908	77937
98-04	Pre Runner	G51077	81871	77494
	Pre Runner, Exc. Upgrade HD	G51868	G63494
	Pre Runner, Izquierdo	G51868	61699
	Pre Runner, Derecho	G51868	61700
95-04	Todos	G51868
	4WD	G51077	143325 ⁵³	81871	77494
	4WD, Exc. Upgrade HD	G51868	G63494

53 Montaje de Strut. Es probable reutilizar algunas partes del E.O.

98 Nota: El nivel de dificultad para instalar este producto es moderadamente alto. Por favor revise las instrucciones cuidadosamente antes de comenzar.

Texto en Negritas - Número de Parte Nuevo / Futuro

















AMORTIGUADORES Y STRUTS

Año	Notas de Aplicación	Front					Rear				
			Ultra	ProGuard\ Guardian	LTV\ Max Control	Protector de Strut\ Bases de Strut	HiJacker\ Soporte\ Hidráulico		Ultra	ProGuard\ Guardian	LTV\ Max Control

TOYOTA

TOYOTA



































TACOMA (cont)

04	Base, 4WD		G51868		61510
	Base, RWD		G63937		G63689	61500
	Base, RWD, Exc. Offroad Package		G51868	61606 81908	77937	
95-03	DLX, 4WD		G51868		61510
	DLX, RWD		G63937		G63689	61500
	DLX, RWD, Exc. Offroad Package		G51868	61606 81908	77937	
98-00	Limited		G51868		61510
	SR5, 4WD		G51868		61500

TACOMA READYMOUNTS

		Delantero	Trasero
05-12	Izquierdo	G57133³
	Derecho	G57134³
98-04	Pre Runner, 4WD, RWD	G57010⁴⁰
95-97	4WD	G57010⁴⁰

TERCEL

95-99	Todos		G55879	142307 ⁵³		G51252
91-94	Todos		G55828	142307 ⁵³		G55804
89-90	Todos		G44743 ⁹⁸	
	Hatchback		G44743 ⁹⁸		G51180
	Sedan		G44743 ⁹⁸		G51180
87-88	4WD, Wagon		G44800 ⁹⁸		81498
	Hatchback		G44743 ⁹⁸		G51180
	Sedan		G44743 ⁹⁸		G51180
88	Wagon		142247 ⁵³	
87	FWD, Wagon		G44748 ⁹⁸		G55752
	Wagon		142247 ⁵³		142249 ⁵³
83-86	Todos			G55752	142249 ⁵³
	4WD, Wagon		G44800 ⁹⁸		G55752	81498	142249 ⁵³
	FWD		G44748 ⁹⁸		G55752	142249 ⁵³
	Wagon		142247 ⁵³		G55752	142249 ⁵³
80-82	AL1 (Cdigo plataforma del fabricante)		G44723	
	AL1 (Cdigo plataforma del fabricante)			82013

3 Número de parte futuro

53 Montaje de Strut. Es probable reutilizar algunas partes del E.O.

40 Strut ReadyMount. Ensemble Completo

98 Nota: El nivel de dificultad para instalar este producto es moderadamente alto. Por favor revise las instrucciones cuidadosamente antes de comenzar.

Texto en Negritas - Número de Parte Nuevo / Futuro

AMORTIGUADORES Y STRUTS

Año	Notas de Aplicación	Front					Rear				
		Ultra	ProGuard\ Guardian	LTV\ Max Control	Protector de Strut\ Bases de Strut	HiJacker\ Soporte\ Hidráulico	Ultra	ProGuard\ Guardian	LTV\ Max Control	Protector de Strut\ Bases de Strut	HiJacker\ Soporte\ Hidráulico

TOYOTA

TOYOTA

TUNDRA

14-16	Todos	↓	143339 ⁵³	↓
	w/Offroad Package	↓	143339 ⁵³	↓	143340 ⁵³
07-13	Todos	↓	G51855	143339 ⁵³	↓	G64038
	w/Offroad Package	↓	G51855	143339 ⁵³	↓	G64038	143340 ⁵³
00-06	Todos	↓	G51477	143325 ⁵³	↓	G63815	77815

TUNDRA READYMOUNTS

		Delantero	Trasero
12-13	RWD; Exc. Extended Cab; Offroad y Long bed Izquierdo	G57123⁴⁰
	RWD; Exc. Extended Cab; Offroad y Long bed Derecho	G57124⁴⁰
07-11	RWD; Exc. Extended Cab; Offroad y Long bed Izquierdo	G57123³
	RWD; Exc. Extended Cab; Offroad y Long bed Derecho	G57124³
00-06	Todos	G57027⁴⁰

VAN

87-89	4WD	↓	G63612	↓
	Coil(RearSpringType)	↓	↓	G63484	81542
	RWD	↓	G63900	61529	↓
87-88	Leaf Rear Spring Type	↓	↓	70163
	Leaf(RearSpringType)	↓	↓	G63907	61500 81147	77907	43048 ⁸ 49310 ⁷
84-86	Todos	↓	G63900	61529	↓
	Coil(RearSpringType)	↓	G63900	61529	↓	G63484	81542
	Leaf Rear Spring Type	↓	G63900	61529	↓	70163
	Leaf(RearSpringType)	↓	G63900	61529	↓	G63907	61500 81147	77907	43048 ⁸ 49310 ⁷

VAN WAGON

88	Todos	↓	↓	61500	43048 ⁸ 49310 ⁷
	Coil(RearSpringType), Coil(FrontSpringType)	↓	G63612	↓	G63484	61500	43048 ⁸ 49310 ⁷
	Leaf Rear Spring Type	↓	↓	61500	70163 43048 ⁸ 49310 ⁷
	Leaf(RearSpringType), Leaf(FrontSpringType)	↓	G63900	↓	G63907	61500	77907	43048 ⁸ 49310 ⁷
	RWD	↓	61529	↓	61500	43048 ⁸ 49310 ⁷
	RWD; Resorte Trasero	↓	↓	81542 61500	43048 ⁸ 49310 ⁷
	RWD; Resorte Trasero de Hojas Múltiples	↓	↓	81147 61500	43048 ⁸ 49310 ⁷

VENZA

09-11	Mount Kit w/ Strut Mount, Bearing & 3 Nuts	↓	143402	↓
-------	--	---	------	------	------	--------	------	---	------	------	------	------	------

YARIS

06-13	Izquierdo	↓	G56842	143417	↓	G51783
-------	-----------	---	--------	------	------	--------	------	---	--------	------	------	------	------

3 Número de parte futuro

8 Paquetes en pares



53 Montaje de Strut. Es probable reutilizar algunas partes del E.O.

Texto en Negritas - Número de Parte Nuevo / Futuro

7 Paquetes en pares; kit de mangueras de aire incluido

40 Strut ReadyMount. Ensemble Completo





AMORTIGUADORES Y STRUTS

Año	Notas de Aplicación										
		Ultra	ProGuard\ Guardian	LTV\ Max Control	Protector de Strut\ Bases de Strut	HiJacker\ Soporte\ Hidráulico	Ultra	ProGuard\ Guardian	LTV\ Max Control	Protector de Strut\ Bases de Strut	HiJacker\ Soporte\ Hidráulico

TOYOTA

TOYOTA



YARIS (cont)

06-13	Derecho		G56843	143417		G51783
03-05	Todos		G52590		69450

TRIUMPH

TRIUMPH

SPITFIRE

63-80	Todos			82139
-------	-------	---	------	------	------	------	------	---	------	-------	------	------	------















VOLKSWAGEN

VOLKSWAGEN

ATLANTIC

77-87	Todos		G44763	44763		G51006	51006
-------	-------	---	--------	------	------	------	-------	---	--------	------	------	------	-------

BEETLE

12-16	Todos		G56899		G51799
98-11	Todos		G56606	142651 ⁵⁴		69945	81934	142654 ⁵³
73-79	Todos		G44850	82005		42094
67-77	Todos		82005	42161		82001	49307 42094
66	1200		82001	42094		82001	49307 42094
	1300 y 1500		82005	42161		82001	49307 42094
52-65	Todos		82001	42094		82001	49307 42094

BEETLE ESTABILIZADORES DE DIRECCIÓN

		Delantero	Trasero
59-77	Todos	14004

BEETLE READYMOUNTS

		Delantero	Trasero
98-11	Todos	G57039 ⁴⁰



40 Strut ReadyMount. Ensamble Completo

54 Kit con Montaje y Rodamiento. Es probable que reutilizar algunas partes del E.O.

Texto en Negritas - Número de Parte Nuevo / Futuro

53 Montaje de Strut. Es probable reutilizar algunas partes del E.O.

AMORTIGUADORES Y STRUTS

Año	Notas de Aplicación										
		Ultra	ProGuard\ Guardian	LTV\ Max Control	Protector de Strut\ Bases de Strut	HiJacker\ Soporte\ Hidráulico	Ultra	ProGuard\ Guardian	LTV\ Max Control	Protector de Strut\ Bases de Strut	HiJacker\ Soporte\ Hidráulico

VOLKSWAGEN

BORA

12-14	Todos	G511081
	1.9L TDI	G52311	G51950 G511081
	Exc. 1.9L TDI models	G56899	G51799 G511081
04-11	Exc. 1.9L TDI models	G56899	G51799
11	1.9L TDI	G52311	G51950
06-10	Con cilindro de 50mm	G52311	G51950
06-10	Con cilindro de 55mm	G56899	G51799

VOLKSWAGEN

BRASILIA

74-83	Todos	82005	42161	82001	42094
-------	-------	------	-------	------	------	-------	------	-------	------	------	-------

CABRIO

95-02	Todos	G55989
-------	-------	--------	------	------	------	------	------	------	------	------	------

CABRIOLET

85-93	Todos	G44763 ⁹⁸	G51006
-------	-------	----------------------	------	------	------	------	--------	------	------	------	------

CARIBE

77-87	Todos	G44763	44763	G51006	51006
-------	-------	--------	------	------	------	-------	--------	------	------	------	-------

CC

09-14	Todos	G56899	143344 ⁵³	G51799	143345 ⁵³
-------	-------	--------	------	------	----------------------	------	--------	------	------	----------------------	------

CLÁSICO

10-12	Todos	G56606	69945
-------	-------	--------	------	------	------	------	-------	------	------	------	------

COMBI

72-01	Todos	G63841	42953	G63455	61614 81821	42952
-------	-------	--------	------	------	------	-------	--------	----------------	------	------	-------

COMBI CARAVEL

52-77	Todos	G63841	42953	G63455	61614 81821	42952
-------	-------	--------	------	------	------	-------	--------	----------------	------	------	-------

COMBI PANEL

72-01	Todos	G63841	42953	G63455	61614 81821	42952
-------	-------	--------	------	------	------	-------	--------	----------------	------	------	-------

CORRADO





92-94	VR6	G55989
90-92	Struts Delanteros Reconstruibles	G44774 ⁹⁸

53 Montaje de Strut. Es probable reutilizar algunas partes del E.O.



98 Nota: El nivel de dificultad para instalar este producto es moderadamente alto. Por favor revise las instrucciones cuidadosamente antes de comenzar.

Texto en Negritas - Número de Parte Nuevo / Futuro





AMORTIGUADORES Y STRUTS

Año	Notas de Aplicación										
			ProGuard\ Guardian	LTV\ Max Control	Protector de Strut\ Bases de Strut	HiJacker\ Soporte\ Hidráulico		ProGuard\ Guardian	LTV\ Max Control	Protector de Strut\ Bases de Strut	HiJacker\ Soporte\ Hidráulico



VOLKSWAGEN CORSA

84-88	Todos		G44902	44902		G51017	51017
-------	-------	---	--------	------	------	------	-------	---	--------	------	------	------	-------







CRAFTER

08-13	30 - 35		G52343		G64091
	50		G52341		G64089





CROSSFOX

05-14	Asiento de resorte bajo		G52217		G64062
-------	-------------------------	---	--------	------	------	------	------	---	--------	------	------	------	------





DERBY

00-07	Todos		G35066	55991		G51735
95-99	Todos		G35066	55991		G51022	51091
94	4Cyl		G35066	55991		G51022	51091





EOS

11-14	Todos		G56899		G51799
07-13	Exc. Suspensión Electrónica		143344 ⁵³		70061	143345 ⁵³



EUROVAN

05-12	TDI Diesel		G52342		G64090
00-04	Todos		69581		69582

FASTBACK

69-73	Todos		82001		82001	49307 ⁷
66-68	Todos		82001		82001



FOX

87-93	Todos		G44902 ⁹⁸		G51030 ⁵⁰
-------	-------	---	----------------------	------	------	------	------	---	----------------------	------	------	------	------

7 Paquetes en pares; kit de mangueras de aire incluido
53 Montaje de Strut. Es probable reutilizar algunas partes del E.O.

50 Para proteger la barra del pistón, se recomienda utilizar el kit Bellows No.141242.
98 Nota: El nivel de dificultad para instalar este producto es moderadamente alto. Por favor revise las instrucciones cuidadosamente antes de comenzar.

AMORTIGUADORES Y STRUTS

Año	Notas de Aplicación										
		Ultra	ProGuard\ Guardian	LTV\ Max Control	Protector de Strut\ Bases de Strut	HiJacker\ Soporte\ Hidráulico	Ultra	ProGuard\ Guardian	LTV\ Max Control	Protector de Strut\ Bases de Strut	HiJacker\ Soporte\ Hidráulico

VOLKSWAGEN

GOL

09-16	Todos	G52218	G51895
-------	-------	--------	------	------	------	------	--------	------	------	------	------

GOLF

07-09	A6 - Montura inferior de 55 mm	G56899	G51799	143345
	A6 - Montura inferior de 50 mm	G52311	G51950
00-07	A4 - Inc. GTI	G56606	142651	69945	81394
96-98	A3	G35066	142444 143058	55991	G51022	142252 142573 143063	51022
	A3 - VR6	G55989	142444 143058	G51022	142252 142573 143063	51022
92-95	A3	G35066	142444 143058	55991	G51022	142252 142573 143063	51022
	A3 - VR6	G55990	142444 143058	G51022	142252 142573 143063	51022
87-91	A2	G35066	142444 143058	55991	G51022	142252 142573 143063	51022

GOLF SPORTWAGEN

10-13	Todos	G56899	G51799	143345
-------	-------	--------	------	------	------	------	--------	------	------	--------	------

GOLF READYMOUNTS

		Delantero		Trasero	
99-06	Todos	G57039 ⁴⁰		
97-98	Todos	G57006 ⁴⁰		G57024 ⁴⁰	
85-96	Todos	G57005 ⁴⁰		G57024 ⁴⁰	

GTI





07-13	Todos	G56899	143344 ⁵³	G51799	143345 ⁵³
-------	-------	--------	------	------	----------------------	------	--------	------	------	----------------------	------

6 Se recomienda que cuando se reemplacen amortiguadores "quad", los 4 sean de la 40 Strut ReadyMount. Ensamble Completo misma serie.

53 Montaje de Strut. Es probable reutilizar algunas partes del E.O.

Texto en Negritas - Número de Parte Nuevo / Futuro

AMORTIGUADORES Y STRUTS

Año	Notas de Aplicación										
			Ultra	ProGuard\ Guardian	LTV\ Max Control	Protector de Strut\ Bases de Strut	HiJacker\ Soporte\ Hidráulico		Ultra	ProGuard\ Guardian	LTV\ Max Control

















VOLKSWAGEN

VOLKSWAGEN

HORMIGA

76-78	1.6L 4Cyl (98) 1BBL		82031		82032
-------	---------------------	---	------	-------	------	------	------	---	------	-------	------	------	------





JETTA

10-14	A6 - Montura inferior de 55 mm		G56899		G51799	143345
11-13	A6 - Montura inferior de 50 mm		G52311		G51950
99-15	A4 - Sedan exc. TDI		G56606	142651		69945	81394
96-98	A3		G35066	142444 143058	55991		G51022	142252 142573 143063	51022
	A3 - VR6		G55989	142444 143058		G51022	142252 142573 143063	51022
92-95	A3		G35066	142444 143058	55991		G51022	142252 142573 143063	51022
	A3 - VR6		G55990	142444 143058		G51022	142252 142573 143063	51022
87-91	A2		G35066	142444 143058	55991		G51022	142252 142573 143063	51022

53 Montaje de Strut. Es probable reutilizar algunas partes del E.O.

Texto en Negritas - Número de Parte Nuevo / Futuro





AMORTIGUADORES Y STRUTS

Año	Notas de Aplicación										
		 Ultra	ProGuard\ Guardian	LTV\ Max Control	Protector de Strut\ Bases de Strut	HiJacker\ Soporte\ Hidráulico	 Ultra	ProGuard\ Guardian	LTV\ Max Control	Protector de Strut\ Bases de Strut	HiJacker\ Soporte\ Hidráulico

VOLKSWAGEN

JETTA (cont)

VOLKSWAGEN

85-86	A2	 G55990		142573 ⁶
80-84	Todos	 G44763 ⁹⁸	 G51006

JETTA READYMOUNTS

		Delantero	Trasero
08-12	Wagon	G57156⁴⁰
06-12	Sedan; Exc. GLI	G57156⁴⁰
06	Wagon	G57156⁴⁰

6 Se recomienda que cuando se reemplacen amortiguadores "quad", los 4 sean de la misma serie.





53 Montaje de Strut. Es probable reutilizar algunas partes del E.O.

Texto en Negritas - Número de Parte Nuevo / Futuro

40 Strut ReadyMount. Ensamble Completo

98 Nota: El nivel de dificultad para instalar este producto es moderadamente alto. Por favor revise las instrucciones cuidadosamente antes de comenzar.

AMORTIGUADORES Y STRUTS

Año	Notas de Aplicación										
			Ultra	ProGuard\ Guardian	LTV\ Max Control	Protector de Strut\ Bases de Strut	HiJacker\ Soporte\ Hidráulico		Ultra	ProGuard\ Guardian	LTV\ Max Control



VOLKSWAGEN

VOLKSWAGEN





JETTA READYMOUNTS (cont)

		Delantero	Trasero
99-05	Todos	G57039 ⁴⁰
97-98	Todos	G57006 ⁴⁰	G57024 ⁴⁰
85-96	Todos	G57005 ⁴⁰	G57024 ⁴⁰

LUPO

04-09	Todos		G52048	143292		70007
-------	-------	---	--------	------	------	--------	------	---	-------	------	------	------	------

PASSAT

06-14	Todos		G56899	143344		G51799	143345 ⁵³
01-05	Exc. Número de Identificación de Vehículo (VIN) #3B300001 al #3B300000		G511057	142652 ⁵⁴		G51742

PASSAT READYMOUNTS



		Delantero	Trasero
06-09	2.0T	G57156 ⁴⁰
01-05	Izquierdo	G57135 ⁴⁰
	Derecho	G57136 ⁴⁰

40 Strut ReadyMount. Ensamble Completo
54 Kit con Montaje y Rodamiento. Es probable que reutilizar algunas partes del E.O.



53 Montaje de Strut. Es probable reutilizar algunas partes del E.O.
98 Nota: El nivel de dificultad para instalar este producto es moderadamente alto. Por favor revise las instrucciones cuidadosamente antes de comenzar.

Texto en Negritas - Número de Parte Nuevo / Futuro



AMORTIGUADORES Y STRUTS

Año	Notas de Aplicación										
		Ultra	ProGuard\ Guardian	LTV\ Max Control	Protector de Strut\ Bases de Strut	HiJacker\ Soporte\ Hidráulico	Ultra	ProGuard\ Guardian	LTV\ Max Control	Protector de Strut\ Bases de Strut	HiJacker\ Soporte\ Hidráulico





VOLKSWAGEN POINTER

98-08	Todos	 G44902	44902	 G51294	51294
-------	-------	--	------	------	------	-------	--	------	------	------	-------



POINTER PICK UP

98-08	Todos	 G44902	44902	 G51731
-------	-------	--	------	------	------	-------	--	------	------	------	------



POLO

14	Todos	 G52585	
03-07	Todos	 G52048	 70007







QUANTUM

82-88	Todos	 G44902 ⁹⁸	142195 ⁵³	
-------	-------	--	------	------	----------------------	------	---	------	------	------	------



R32

08	Todos		143344 ⁵³		143345 ⁵³
----	-------	---	------	------	----------------------	------	---	------	------	----------------------	------



RABBIT

12-14	Todos		 G511081
06-09	Todos	 G56899	143344 ⁵³	 G51799	143345 ⁵³
75-84	Todos	 G44763 ⁹⁸	 G51006

RABBIT PICKUP

80-83	Todos	 G44763 ⁹⁸	
-------	-------	--	------	------	------	------	---	------	------	------	------





ROUTAN

09-11	Exc. Suspensión Autonivelable	 G52131	143463 ⁵³	 G64042
-------	-------------------------------	--	------	------	----------------------	------	--	------	------	------	------

ROUTAN READYMOUNTS

09-10	Todos						Delantero		Trasero		
							G57206 ⁴⁰			



SAFARI

74-80	1.6L 4Cyl (98) 1BBL		82005	42161		82001	42094
73	1.5L 4Cyl (92) 1BBL		82005	42161		82001	42094

SAFARI ESTABILIZADORES DE DIRECCIÓN

73-80	Todos						Delantero		Trasero		
							14004			

SAVEIRO

10-12	Todos	 G52217	
-------	-------	--	------	------	------	------	---	------	------	------	------





40 Strut ReadyMount. Ensemble Completo

53 Montaje de Strut. Es probable reutilizar algunas partes del E.O.

98 Nota: El nivel de dificultad para instalar este producto es moderadamente alto. Por favor revise las instrucciones cuidadosamente antes de comenzar.



Texto en Negritas - Número de Parte Nuevo / Futuro

AMORTIGUADORES Y STRUTS









Año	Notas de Aplicación										
			Ultra	ProGuard\ Guardian	LTV\ Max Control	Protector de Strut\ Bases de Strut	HiJacker\ Soporte\ Hidráulico		Ultra	ProGuard\ Guardian	LTV\ Max Control

VOLKSWAGEN SCIROCCO

VOLKSWAGEN

75-89	Todos		G44763 ⁹⁸		G51006
-------	-------	---	----------------------	------	------	------	------	---	--------	------	------	------	------



SEDAN

95-02	Todos		82005	42161		82001	42094
89-02	Todos		82005	42161		82001	42094
73-87	Todos		82005	42161		82001	42094
52-72	Todos		82001	42094		82001	42094



SEDAN ESTABILIZADORES DE DIRECCIÓN

		Delantero		Trasero	
89-02	Todos	14004		
73-87	Todos	14004		

SHARAN

02-08	Todos		G52886		69924
-------	-------	---	--------	------	------	------	------	---	-------	------	------	------	------











SPORTVAN

06-10	Todos		G52213		G64060
-------	-------	---	--------	------	------	------	------	---	--------	------	------	------	------

SQUAREBACK

66-73	Todos		82001		82001	49307 ⁷
-------	-------	--	------	-------	------	------	------	--	------	-------	------	------	--------------------

SUPER BEETLE

74-79	Todos		G44850 ⁹⁸	82005		82001	49307 ⁷
73	Todos		82005	
	Montaje inferior con 3 pernos tipo brida		G44862 ⁹⁸	82005		82001	49307 ⁷
	Montaje inferior de 2 pernos tipo brida		G44850 ⁹⁸	82005	
71-72	Montaje inferior con 3 pernos tipo brida		G44862 ⁹⁸		82001	49307 ⁷

SUPER BEETLE ESTABILIZADORES DE DIRECCIÓN

		Delantero		Trasero	
71-75	Todos	14005		







THING

73-74	Todos		82005		82001	49307 ⁷
-------	-------	---	------	-------	------	------	------	---	------	-------	------	------	--------------------

THING ESTABILIZADORES DE DIRECCIÓN

		Delantero		Trasero	
73-74	Todos	14004		

TIGUAN



12-14	Todos		G56899	
09-11	Todos		G52301	
	Todos		G52301	143344 ⁵³		G51993	143345 ⁵³

7 Paquetes en pares; kit de mangueras de aire incluido





53 Montaje de Strut. Es probable reutilizar algunas partes del E.O.

98 Nota: El nivel de dificultad para instalar este producto es moderadamente alto. Por favor revise las instrucciones cuidadosamente antes de comenzar.

AMORTIGUADORES Y STRUTS









Año	Notas de Aplicación										
		Ultra	ProGuard\ Guardian	LTV\ Max Control	Protector de Strut\ Bases de Strut	HiJacker\ Soporte\ Hidráulico	Ultra	ProGuard\ Guardian	LTV\ Max Control	Protector de Strut\ Bases de Strut	HiJacker\ Soporte\ Hidráulico

VOLKSWAGEN TOUAREG





04-09	Izquierdo	 G52348	 G51928
	Derecho	 G52349	 G51928

VOLKSWAGEN





TRANSPORTER

10-14	Todos	 G52342	 70105
70-79	Todos		82031		82032
68-69	Todos		82001		82032
56-67	Todos		82001		82001



VANAGON

80-91	RWD	 69861	 69858
86-89	4WD		 G63454	61539 81581	49215 ⁷

VARIANT

86	1.3L 4Cyl (78) 1BBL	 G44902	
	1.6L 4Cyl (98) 2BBL	 G44902	



VENTO

14-16	Todos	 G52585	 70127
-------	-------	--	------	------	------	------	---	------	------	------	------





VOLVO

VOLVO

122

59-68	Todos		82026		81270	49105 ⁷
-------	-------	--	-------	------	------	------	--	-------	------	------	--------------------



142 / 144 / 145 / 164

75	Todos	 69600	81494	 69787 ³
68-74	Todos	 69600	81494	





240 / 242 / 244 / 245 / 262 / 264 / 265

75-93	Todos	 G44856 ⁹⁸	 69787 ³
-------	-------	--	------	------	------	------	--	------	------	------	------

544

59-65	Todos			82123
-------	-------	--	------	------	------	------	--	-------	------	------	------

740 / 745 / 760 / 780

84-92	Fab. desde 5/84; Exc. Sistema de Nivelación Hidráulica	 G44941 ⁹⁸	 69805 ³²
89	Exc. Sistema de Autonivelación NIVOMAT	 G44941 ⁹⁸	



3 Número de parte futuro

32 Con Susp. NIVOMAT, reemplace el resorte con el No. Volvo 1359710 o 1273977.

7 Paquetes en pares; kit de mangueras de aire incluido

98 Nota: El nivel de dificultad para instalar este producto es moderadamente alto. Por favor revise las instrucciones cuidadosamente antes de comenzar.



AMORTIGUADORES Y STRUTS

Año	Notas de Aplicación										
		Ultra	ProGuard\ Guardian	LTV\ Max Control	Protector de Strut\ Bases de Strut	HiJacker\ Soporte\ Hidráulico	Ultra	ProGuard\ Guardian	LTV\ Max Control	Protector de Strut\ Bases de Strut	HiJacker\ Soporte\ Hidráulico

VOLVO

VOLVO





850

93-97	Exc. Sistema de Autonivelación NIVOMAT		G56612	143191 ⁵³		69901	142941 ⁵³
-------	--	---	--------	------	------	----------------------	------	---	-------	------	------	----------------------	------







850 READYMOUNTS

										Delantero	Trasero		
93-97	Exc. Sistema de Autonivelación NIVOMAT											G57040 ⁴⁰



940

91-95	Exc. Sistema de Autonivelación NIVOMAT		G44941 ⁹⁸	
	Exc. Sistema de Autonivelación NIVOMAT			69805 ³²





960

94-97	Fab. desde 10/94; Exc. Sistema de Autonivelación Hidráulica			69417 ³²
95	Fab. hasta 10/94 Exc. Sistema Autonivelación NIVOMAT		G44941 ⁹⁸	
92-94	Fab. hasta 10/94 Exc. Sistema Autonivelación NIVOMAT		G44941 ⁹⁸		69805 ³²







1800

61-73	Todos		82026	
-------	-------	---	------	-------	------	------	------	---	------	------	------	------	------

C30

07-13	Izquierdo		G52274		70056
	Derecho		G52275		70056



C70

06-13	Izquierdo		G52274		70056
	Derecho		G52275		70056
98-04	Todos		G56612	143191 ⁵³		69901	142941 ⁵³



C70 READYMOUNTS

										Delantero	Trasero		
98-04	Todos											G57040 ⁴⁰



DL

84	Exc. Sistema de Autonivelación NIVOMAT		G44856 ⁹⁸		69787 ³
----	--	---	----------------------	------	------	------	------	---	--------------------	------	------	------	------

GLE

84	Exc. Sistema de Autonivelación NIVOMAT		G44856 ⁹⁸		69787 ³
----	--	---	----------------------	------	------	------	------	---	--------------------	------	------	------	------

PV 444

49	Todos			82123
----	-------	---	------	------	------	------	------	---	------	-------	------	------	------

3 Número de parte futuro

40 Strut ReadyMount. Ensemble Completo

98 Nota: El nivel de dificultad para instalar este producto es moderadamente alto. Por favor revise las instrucciones cuidadosamente antes de comenzar.

Texto en Negritas - Número de Parte Nuevo / Futuro

32 Con Susp. NIVOMAT, reemplace el resorte con el No. Volvo 1359710 o 1273977.

53 Montaje de Strut. Es probable reutilizar algunas partes del E.O.

AMORTIGUADORES Y STRUTS

Año	Notas de Aplicación	Front					Rear				
		Ultra	ProGuard\ Guardian	LTV\ Max Control	Protector de Strut\ Bases de Strut	HiJacker\ Soporte\ Hidráulico	Ultra	ProGuard\ Guardian	LTV\ Max Control	Protector de Strut\ Bases de Strut	HiJacker\ Soporte\ Hidráulico

VOLVO

VOLVO

S40

10-12	Todos	70056
05-09	Izquierdo	G52274	70056
	Derecho	G52275	70056
00-04	Todos	143421 ⁵³	143422 ⁵³
	Fab. desde 4/00 Izquierdo	G52079	143421 ⁵³	G51841	143422 ⁵³
	Fab. desde 4/00 Derecho	G52080	143421 ⁵³	G51841	143422 ⁵³
04	T5, Izquierdo	G52274	143421 ⁵³	70056	143422 ⁵³
	T5, Derecho	G52275	143421 ⁵³	70056	143422 ⁵³

S60

08-09	Todos	G56802
	FWD	G56802	70040
04-07	Todos	G56802	143191 ⁵³
	FWD	G56802	143191 ⁵³	70040
01-03	Todos	G56802	143191 ⁵³	70040

S60 READYMOUNTS

		Delantero		Trasero	
01-06	FWD	G57171 ⁴⁰		

S70

98-00	Todos	G56612	143191 ⁵³	69901	142941 ⁵³
-------	-------	--------	-------	-------	----------------------	-------	-------	-------	-------	----------------------	-------

S70 READYMOUNTS

		Delantero		Trasero	
98-00	Todos	G57040 ⁴⁰		

S80

99-06	Todos	G56802
	Exc. Suspensión Trasera Nivomat	G56802	143191 ⁵³

S80 READYMOUNTS

		Delantero		Trasero	
99-03	Todos	G57171 ⁴⁰		

S90

97-98	Fab. desde 5/97; Exc. Sistema de Autonivelación Hidráulica	69417 ³²
-------	--	-------	-------	-------	-------	-------	---------------------	-------	-------	-------	-------

V40

00-04	Todos	143421 ⁵³	143422 ⁵³
	Fab. desde 4/00 Izquierdo	G52079	143421 ⁵³	G51841	143422 ⁵³
	Fab. desde 4/00 Derecho	G52080	143421 ⁵³	G51841	143422 ⁵³

32 Con Susp. NIVOMAT, reemplace el resorte con el No. Volvo 1359710 o 1273977. 40 Strut ReadyMount. Ensamble Completo

53 Montaje de Strut. Es probable reutilizar algunas partes del E.O.

Texto en Negritas - Número de Parte Nuevo / Futuro

AMORTIGUADORES Y STRUTS

Año	Notas de Aplicación	Front					Rear				
		Ultra	ProGuard\ Guardian	LTV\ Max Control	Protector de Strut\ Bases de Strut	HiJacker\ Soporte\ Hidráulico	Ultra	ProGuard\ Guardian	LTV\ Max Control	Protector de Strut\ Bases de Strut	HiJacker\ Soporte\ Hidráulico

VOLVO

VOLVO

V50

04-12	Todos	IO	70056
05-09	Izquierdo	G52274	IO	70056
	Derecho	G52275	IO	70056

V70

01-07	Exc. Suspensión Electrónica / Nivomat	IO	70040
	Exc. XC70, XC Cross Country y Exc. Sistema de Autonivelación	G52274	143191 ⁵³	IO
00-06	Fab. desde 3/00 y Exc. XC70, XC Cross Country y Autonivelación	G56802	IO
98-00	Exc. XC70, XC Cross Country y Exc. Sistema de Autonivelación	G52274	143191 ⁵³	IO	142941 ⁵³
	Fab. hasta 3/00 y Exc. XC70, XC Cross Country	G56612	IO	69901

V70 READYMOUNTS

		Delantero		Trasero	
00-07	Todos	G57171 ⁴⁰		
00	Fab. hasta 3/00 y Exc. XC70, XC Cross Country	G57040 ⁴⁰		
98-99	Fab. hasta 3/00 y Exc. XC70, XC Cross Country	G57040 ⁴⁰		

V90

97-98	Fab. desde 5/97; Exc. Sistema de Autonivelación Hidráulica	IO	69417 ³²
-------	--	-------	-------	-------	-------	-------	----	---------------------	-------	-------	-------	-------

XC90

07-08	Todos	G52295	IO
04-06	Todos	G52295	143191 ⁵³	IO
03	Todos	G52295	IO
	AWD	G52295	143191 ⁵³	IO

32 Con Susp. NIVOMAT, reemplace el resorte con el No. Volvo 1359710 o 1273977.

40 Strut ReadyMount. Ensamble Completo

53 Montaje de Strut. Es probable reutilizar algunas partes del E.O.

Texto en Negritas - Número de Parte Nuevo / Futuro

Lista numérica

Amort.	POP	No. Alternativo	Montaje Accesorio
Pos.	Año	Aplicación	

Amortiguadores de Dirección

Amort.	POP	No. Alternativo	Montaje Accesorio
Pos.	Año	Aplicación	
6801SE A 500498,142037			
F	83-94	CHEVROLET BLAZER, S MODELS Todos Estabilizador de Dirección Sistema Sencillo; con orificio de montaje de EO en brazo de dirección	
F	79-82	LUV PICKUP 4x4 Estabilizador de Dirección Sistema Sencillo; con orificio de montaje de EO en brazo de dirección	
F	83-04	S10 4x4 Estabilizador de Dirección Sistema Sencillo; con orificio de montaje de EO en brazo de dirección	
F	83-91	GMC S15 JIMMY Todos Estabilizador de Dirección Sistema Sencillo; con orificio de montaje de EO en brazo de dirección	
F	91-93	SONOMA / S15 Todos Estabilizador de Dirección Sistema Sencillo; con orificio de montaje de EO en brazo de dirección	
F	82-90	SONOMA / S15 4x2 Tracción trasera Estabilizador de Dirección Sistema Sencillo; con orificio de montaje de EO en brazo de dirección	
F	91	SYCLONE Todos Estabilizador de Dirección Sistema Sencillo; con orificio de montaje de EO en brazo de dirección	
F	84-00	JEEP CHEROKEE Todos Estabilizador de Dirección Sistema Sencillo; con orificio de montaje de EO en brazo de dirección	
F	86-92	COMANCHE Todos Estabilizador de Dirección Sistema Sencillo; con orificio de montaje de EO en brazo de dirección	
F	97-06	WRANGLER TJ (Código plataforma del fabricante) Estabilizador de Dirección Sistema Sencillo; con orificio de montaje de EO en brazo de dirección	
F	94-95	WRANGLER YJ (Código plataforma del fabricante) Estabilizador de Dirección Sistema Sencillo; con orificio de montaje de EO en brazo de dirección	
F	87-92	WRANGLER YJ (Código plataforma del fabricante) Estabilizador de Dirección Sistema Sencillo; con orificio de montaje de EO en brazo de dirección	

Amort.	POP	No. Alternativo	Montaje Accesorio
Pos.	Año	Aplicación	
6802SE C 141998			
F	79-86	CHEVROLET BLAZER 4x4 Estabilizador de Dirección Sistema Dual	
F	79-84	BLAZER 4x2 Tracción trasera Estabilizador de Dirección Sistema Dual	
F	50-58	PICKUP Truck Estabilizador de Dirección Sistema Sencillo c/ Eje de Viga en I	
F	73-86	PICKUP 1/2 TON, C10 Todos Estabilizador de Dirección Sistema Sencillo	
F	67-86	PICKUP 1/2 TON, K10 Todos Estabilizador de Dirección Sistema Dual	
F	87	PICKUP 1/2 TON, R10 Todos Estabilizador de Dirección Sistema Sencillo	
F	87	PICKUP 1/2 TON, V10 Todos Estabilizador de Dirección Sistema Dual	
F	82-86	PICKUP 1 TON, C30 6.2L 8Cyl V (379) Estabilizador de Dirección Sistema Sencillo c/ Cooler	
F	73-86	PICKUP 1 TON, C30 4.8L 6Cyl L (292) Estabilizador de Dirección Sistema Sencillo c/ Cooler	
F	73-86	PICKUP 1 TON, C30 5.7L 8Cyl V (350) Estabilizador de Dirección Sistema Sencillo c/ Cooler	
F	78-80	PICKUP 1 TON, C30 4.1L 6Cyl L (250) Estabilizador de Dirección Sistema Sencillo c/ Cooler	
F	78-79	PICKUP 1 TON, C30 5.0L 8Cyl V (305) Estabilizador de Dirección Sistema Sencillo c/ Cooler	
F	76-79	PICKUP 1 TON, C30 6.6L 8Cyl V (400) Estabilizador de Dirección Sistema Sencillo c/ Cooler	

Amortiguadores de Dirección

Amort.	POP	No. Alternativo	Montaje Accesorio
Pos.	Año	Aplicación	

Amort.	POP	No. Alternativo	Montaje Accesorio
Pos.	Año	Aplicación	
6802SE C -continued 141998			
F	73-75	PICKUP 1 TON, C30 4.1L 6Cyl L (250) Estabilizador de Dirección Sistema Sencillo c/ Cooler	
F	73	PICKUP 1 TON, C30 5.0L 8Cyl V (307) Estabilizador de Dirección Sistema Sencillo c/ Cooler	
F	61-72	PICKUP 1 TON, C30 Todos Estabilizador de Dirección Sistema Sencillo	
F	77-86	PICKUP 1 TON, K30 Todos Estabilizador de Dirección Sistema Dual	
F	87-88	PICKUP 1 TON, R30 4.8L 6Cyl L (292) Estabilizador de Dirección Sistema Sencillo c/ Cooler	
F	87-88	PICKUP 1 TON, R30 5.7L 8Cyl V (350) Estabilizador de Dirección Sistema Sencillo c/ Cooler	
F	87-88	PICKUP 1 TON, R30 6.2L 8Cyl V (379) Estabilizador de Dirección Sistema Sencillo c/ Cooler	
F	89-91	PICKUP 1 TON, R3500 5.7L 8Cyl V (350) Estabilizador de Dirección Sistema Sencillo c/ Cooler	
F	63-86	PICKUP 3/4 TON, C20 Todos Estabilizador de Dirección Sistema Sencillo	
F	67-86	PICKUP 3/4 TON, K20 Todos Estabilizador de Dirección Sistema Dual	
F	87-88	PICKUP 3/4 TON, R20 Todos Estabilizador de Dirección Sistema Sencillo	
F	89	PICKUP 3/4 TON, R2500 Todos Estabilizador de Dirección Sistema Sencillo	
F	87	PICKUP 3/4 TON, V20 Todos Estabilizador de Dirección Sistema Dual	
F	82-03	S10 4x2 Tracción trasera Estabilizador de Dirección Sistema Sencillo	
F	68-86	SUBURBAN 1/2 TON, C10 Todos Estabilizador de Dirección Sistema Sencillo	
F	68-86	SUBURBAN 1/2 TON, K10 Todos Estabilizador de Dirección Sistema Dual	
F	87-88	SUBURBAN 1/2 TON, R10 Todos Estabilizador de Dirección Sistema Dual	
F	89-91	SUBURBAN 1/2 TON, R1500 Todos Estabilizador de Dirección Sistema Sencillo	
F	68-86	SUBURBAN 3/4 TON, C20 Todos Estabilizador de Dirección Sistema Sencillo	
F	68-86	SUBURBAN 3/4 TON, K20 Todos Estabilizador de Dirección Sistema Dual	
F	87-88	SUBURBAN 3/4 TON, R20 Todos Estabilizador de Dirección Sistema Sencillo	
F	89-91	SUBURBAN 3/4 TON, R2500 Todos Estabilizador de Dirección Sistema Sencillo	
F	87-88	SUBURBAN 3/4 TON, V20 Todos Estabilizador de Dirección Sistema Dual	
F	89-91	SUBURBAN 3/4 TON, V2500 Todos Estabilizador de Dirección Sistema Dual	
F	70-95	VAN 1/2 TON, G / EXPRESS Todos Estabilizador de Dirección Sistema Sencillo	
F	71-95	VAN 1 TON, G / EXPRESS Todos Estabilizador de Dirección Sistema Sencillo	
F	70-95	VAN 3/4 TON, G / EXPRESS Todos Estabilizador de Dirección Sistema Sencillo	
F	70	DODGE A100 TRUCK Todos Estabilizador de Dirección Sistema Dual c/ Eje de Viga en I	
F	64-69	A100 TRUCK Todos Sistema Dual	
F	79-82	D50 4x2 Tracción trasera Estabilizador de Dirección Sistema Sencillo	
F	86-89	PICKUP 1/2 TON, D100 SERIES Todos Estabilizador de Dirección Sistema Sencillo	
F	72-79	PICKUP 1/2 TON, D100 SERIES Todos Estabilizador de Dirección Sistema Sencillo	

Lista numérica

Amort.	POP	No. Alternativo	Montaje Accesorio
Pos.	Año	Aplicación	

Amort.	POP	No. Alternativo	Montaje Accesorio
Pos.	Año	Aplicación	
6802SE C -continued 141998			
F	60-71	PICKUP 1/2 TON, D100 SERIES Todos Estabilizador de Dirección Sistema Sencillo c/ Eje de Viga en I	
F	90-93	PICKUP 1/2 TON, W100 SERIES Todos Estabilizador de Dirección Sistema Sencillo	
F	60-86	PICKUP 1/2 TON, W100 SERIES Todos Estabilizador de Dirección Sistema Dual; Exc. Servofreno montado del lado del Eje del Conductor	
F	75-93	PICKUP 1 TON, D300 SERIES Todos Estabilizador de Dirección Sistema Sencillo	
F	72-74	PICKUP 1 TON, D300 SERIES Todos Estabilizador de Dirección Sistema Sencillo c/ Suspensión Delantera de Resorte Helicoidal	
F	60-71	PICKUP 1 TON, D300 SERIES Todos Estabilizador de Dirección Sistema Sencillo c/ Eje de Viga en I	
F	90-93	PICKUP 1 TON, W300 SERIES Todos Estabilizador de Dirección Sistema Sencillo	
F	60-86	PICKUP 1 TON, W300 SERIES Todos Estabilizador de Dirección Sistema Dual; Exc. Servofreno montado del lado del Eje del Conductor	
F	73-93	PICKUP 3/4 TON, D200 SERIES Todos Estabilizador de Dirección Sistema Sencillo	
F	60-71	PICKUP 3/4 TON, D200 SERIES Todos Estabilizador de Dirección Sistema Sencillo c/ Eje de Viga en I	
F	90-93	PICKUP 3/4 TON, W200 SERIES Todos Estabilizador de Dirección Sistema Sencillo	
F	60-86	PICKUP 3/4 TON, W200 SERIES Todos Estabilizador de Dirección Sistema Dual; Exc. Servofreno montado del lado del Eje del Conductor	
F	83-93	PICKUP, RAM 50 4x2 Tracción trasera Estabilizador de Dirección Sistema Sencillo	
F	87-89	RAIDER Todos Estabilizador de Dirección Sistema Sencillo	
F	87-93	RAMCHARGER 4x2 Tracción trasera Estabilizador de Dirección Sistema Sencillo	
F	74-86	RAMCHARGER Todos Estabilizador de Dirección Sistema Dual; Exc. Servofreno montado del lado del Eje del Conductor	
F	71	VAN 1/2 TON, A / B SERIES / RAM Todos Estabilizador de Dirección Sistema Sencillo c/ Eje de Viga en I	
F	71	VAN 1 TON, A / B SERIES / RAM Todos Estabilizador de Dirección Sistema Sencillo c/ Eje de Viga en I	
F	71	VAN 3/4 TON, A / B SERIES / RAM Todos Estabilizador de Dirección Sistema Sencillo c/ Eje de Viga en I	
F	92-96	FORD BRONCO Todos Estabilizador de Dirección Sistema Sencillo	
F	80-91	BRONCO Todos	
F	78-79	BRONCO Todos Estabilizador de Dirección Sistema Dual; Exc. Barra Estabilizadora	
F	84-90	BRONCO II Todos Estabilizador de Dirección Sistema Sencillo	
F	61-67	ECONOLINE VAN Van	
F	91-94	EXPLORER Todos	
F	89-91	F59 Todos Estabilizador de Dirección Sistema Sencillo, Superduty Motorhome	
F	57-59	F SERIES Todos Estabilizador de Dirección Sistema Sencillo c/ Eje de Viga en I	
F	50-55	F SERIES Todos Estabilizador de Dirección Sistema Sencillo c/ Eje de Viga en I	
F	89-91	MOTORHOME CHASSIS / F53 Todos Estabilizador de Dirección Sistema Sencillo Motorhome	
F	80-83	PICKUP 1/2 TON, F-100 4x2 Tracción trasera Estabilizador de Dirección Sistema Sencillo	
F	77-79	PICKUP 1/2 TON, F-100 Todos Estabilizador de Dirección Sistema Dual; Exc. Barra Estabilizadora	

Lista numérica

Amort.	POP	No. Alternativo	Montaje Accesorio
Pos.	Año	Aplicación	
6802SE	C	-continued	141998
F	75-79	PICKUP 1/2 TON, F-100 4x2 Tracción trasera Estabilizador de Dirección Sistema Sencillo c/ Eje de Doble Viga en I	
F	75-76	PICKUP 1/2 TON, F-100 4x4 Estabilizador de Dirección Sistema Dual; Exc. Barra Estabilizadora	
F	94-96	PICKUP 1/2 TON, F-150 4x4 Estabilizador de Dirección Sistema Sencillo c/ Vigas Dobles de Tracción	
F	90-93	PICKUP 1/2 TON, F-150 Todos Estabilizador de Dirección Sistema Sencillo	
F	80-89	PICKUP 1/2 TON, F-150 Todos Estabilizador de Dirección Sistema Dual; Exc. Barra Estabilizadora	
F	77-79	PICKUP 1/2 TON, F-150 Todos Estabilizador de Dirección Sistema Dual; Exc. Barra Estabilizadora	
F	75-76	PICKUP 1/2 TON, F-150 4x4 Tracción trasera	
F	90-92	PICKUP 1/2 TON, F SUPERDUTY Todos	
F	92-96	PICKUP 1 TON, F-350 / SUPERDUTY 4x2 Tracción trasera Estabilizador de Dirección Sistema Dual	
F	89-91	PICKUP 1 TON, F-350 / SUPERDUTY 4x2 Tracción trasera Estabilizador de Dirección Sistema Sencillo	
F	82-88	PICKUP 1 TON, F-350 / SUPERDUTY Todos Estabilizador de Dirección Sistema Sencillo, c/ Barra Estabilizadora	
F	79-81	PICKUP 1 TON, F-350 / SUPERDUTY 4x2 Tracción trasera Estabilizador de Dirección Sistema Dual	
F	75-78	PICKUP 1 TON, F-350 / SUPERDUTY Todos Estabilizador de Dirección Sistema Dual	
F	80-96	PICKUP 3/4 TON, F-250 / SUPERDUTY 4x4 Estabilizador de Dirección Sistema Sencillo	
F	75-79	PICKUP 3/4 TON, F-250 / SUPERDUTY 4x2 Tracción trasera Estabilizador de Dirección Sistema Sencillo	
F	65-67	PICKUP P100 Todos Estabilizador de Dirección Sistema Sencillo	
F	68-73	PICKUP P350 Todos Estabilizador de Dirección Sistema Sencillo	
F	83-97	RANGER Todos Estabilizador de Dirección Sistema Sencillo	
F	69-74	VAN 1/2 TON, ECONOLINE / CLUB WAGON Todos Estabilizador de Dirección Sistema Sencillo c/ Eje de Doble Viga en I	
F	69-74	VAN 3/4 TON, ECONOLINE / CLUB WAGON / SUPERDUTY Todos Estabilizador de Dirección Sistema Sencillo c/ Eje de Doble Viga en I	
F	73-91	GMC JIMMY Todos Amortiguador de reemplazo para vehículos con el kit de montaje de repuesto GRC	
F	70-72	JIMMY 4x4 Estabilizador de Dirección Sistema Dual K5	
F	70-72	JIMMY 4x2 Tracción trasera	
F	53-59	PICKUP Todos Estabilizador de Dirección Sistema Sencillo c/ Eje de Viga en I	
F	73-86	PICKUP 1/2 TON, C15 / C1500 Todos Estabilizador de Dirección Sistema Sencillo	
F	69-86	PICKUP 1/2 TON, K15 / K1500 Todos Estabilizador de Dirección Sistema Dual	
F	87	PICKUP 1/2 TON, R1500 Todos Estabilizador de Dirección Sistema Sencillo	
F	87	PICKUP 1/2 TON, V1500 Todos Estabilizador de Dirección Sistema Dual	
F	75-86	PICKUP 1 TON, C35/3500 Crew Cab Pickup	
F	72-74	PICKUP 1 TON, C35/3500 Todos	
F	67-86	PICKUP 3/4 TON, C25 / C2500 Todos Estabilizador de Dirección Sistema Sencillo	
F	67-86	PICKUP 3/4 TON, K25 / K2500 Todos Estabilizador de Dirección Sistema Dual	
F	87-89	PICKUP 3/4 TON, R2500 Todos Estabilizador de Dirección Sistema Sencillo	

Amortiguadores de Dirección

Amort.	POP	No. Alternativo	Montaje Accesorio
Pos.	Año	Aplicación	
6802SE	C	-continued	141998
F	87	PICKUP 3/4 TON, V2500 Todos AN49	
F	82-93	SONOMA / S15 4x2 Tracción trasera Estabilizador de Dirección Sistema Sencillo	
F	68-86	SUBURBAN 1/2 TON, C15 / C1500 Todos Estabilizador de Dirección Sistema Sencillo	
F	68-86	SUBURBAN 1/2 TON, K15 / K1500 Todos Estabilizador de Dirección Sistema Dual	
F	87-91	SUBURBAN 1/2 TON, R1500 Todos Estabilizador de Dirección Sistema Sencillo	
F	87-91	SUBURBAN 1/2 TON, V1500 Todos Estabilizador de Dirección Sistema Dual	
F	68-86	SUBURBAN 3/4 TON, C25 / C2500 Todos Estabilizador de Dirección Sistema Sencillo	
F	68-86	SUBURBAN 3/4 TON, K25 / K2500 Todos Estabilizador de Dirección Sistema Dual	
F	87-91	SUBURBAN 3/4 TON, R2500 Todos Estabilizador de Dirección Sistema Sencillo	
F	87-91	SUBURBAN 3/4 TON, V2500 Todos Estabilizador de Dirección Sistema Dual	
F	70-95	VAN 1/2 TON, G / SAVANNA Todos Estabilizador de Dirección Sistema Sencillo	
F	71-95	VAN 1 TON, G / SAVANNA Todos Estabilizador de Dirección Sistema Sencillo	
F	70-95	VAN 3/4 TON, G / SAVANNA Todos Estabilizador de Dirección Sistema Sencillo	
F	74	INTERNATIONAL 100 Todos	
F	75	150 Todos	
F	74-75	200 Todos	
F	68-69	908C Todos Estabilizador de Dirección Sistema Sencillo 1/2 Ton, 3/4 Ton y Travelall	
F	68	1000C Todos Estabilizador de Dirección Sistema Sencillo 1/2 Ton, 3/4 Ton y Travelall	
F	69-70	1000D Todos Estabilizador de Dirección Sistema Sencillo 1/2 Ton, 3/4 Ton y Travelall	
F	71-73	1010 Todos Estabilizador de Dirección Sistema Sencillo 1/2 Ton, 3/4 Ton y Travelall	
F	68	1100C Todos Estabilizador de Dirección Sistema Sencillo 1/2 Ton, 3/4 Ton y Travelall	
F	69-70	1100D Todos Estabilizador de Dirección Sistema Sencillo 1/2 Ton, 3/4 Ton y Travelall	
F	71-73	1110 Todos Estabilizador de Dirección Sistema Sencillo 1/2 Ton, 3/4 Ton y Travelall	
F	68	1200C Todos Estabilizador de Dirección Sistema Sencillo 1/2 Ton, 3/4 Ton y Travelall	
F	69-70	1200D Todos Estabilizador de Dirección Sistema Sencillo 1/2 Ton, 3/4 Ton y Travelall	
F	71-73	1210 Todos Estabilizador de Dirección Sistema Sencillo 1/2 Ton, 3/4 Ton y Travelall	
F	68	1300C Todos Estabilizador de Dirección Sistema Sencillo 1/2 Ton, 3/4 Ton y Travelall	
F	69-70	1300D Todos Estabilizador de Dirección Sistema Sencillo 1/2 Ton, 3/4 Ton y Travelall	
F	71-73	1310 Todos Estabilizador de Dirección Sistema Sencillo 1/2 Ton, 3/4 Ton y Travelall	
F	68-71	M800 Todos Estabilizador de Dirección Sistema Sencillo 1/2 y 3/4 Ton c/ Eje de Viga en I	
F	68-72	M1100 / M1200 Todos Estabilizador de Dirección Sistema Sencillo 1/2 y 3/4 Ton c/ Eje de Viga en I	
F	69	M1400 Todos Estabilizador de Dirección Sistema Sencillo 1/2 y 3/4 Ton c/ Eje de Viga en I	
F	61-68	SCOUT Todos Estabilizador de Dirección Sistema Sencillo 4x4; Scout 80, 800	
F	75	TRAVELALL 4x2 Tracción trasera	

Lista numérica

Amort.	POP	No. Alternativo	Montaje Accesorio
Pos.	Año	Aplicación	
6802SE	C	-continued	141998
F	84-91	ISUZU TROOPER 4x4 Estabilizador de Dirección Sistema Sencillo	
F	66-83	JEEP CJ5 Todos Estabilizador de Dirección Sistema Sencillo	
F	59-60	CJ5 Todos Estabilizador de Dirección Sistema Sencillo	
F	66-75	CJ6 Todos Estabilizador de Dirección Sistema Sencillo	
F	59-60	CJ6 Todos Estabilizador de Dirección Sistema Sencillo	
F	76-86	CJ7 Todos Estabilizador de Dirección Sistema Sencillo	
F	66-73	JEEPSTER Todos Estabilizador de Dirección Sistema Sencillo	
F	81-85	SCRAMBLER / CJ8 Todos Estabilizador de Dirección Sistema Sencillo	
F	61-67	UNIVERSAL Todos Estabilizador de Dirección Sistema Sencillo	
F	63-67	WAGONEER Todos Exc. Suspensión Independiente Delantera	
F	91-94	MAZDA NAVAJÓ Todos	
F	95-96	MITSUBISHI MIGHTY MAX Todos Estabilizador de Dirección Sistema Sencillo	
F	83-94	MIGHTY MAX 4x2 Tracción trasera Estabilizador de Dirección Sistema Sencillo	
F	86-95	MONTERO Todos Estabilizador de Dirección Sistema Sencillo	
F	82	NISSAN 720 PICKUP Todos Estabilizador de Dirección Sistema Sencillo	
F	79-82	PLYMOUTH ARROW PICKUP Todos	
F	74-81	TRAILDUSTER Todos Estabilizador de Dirección Sistema Dual; Exc. Servofreno montado del lado del Eje del Conductor	
F	86-95	SUZUKI SAMURAI Todos Estabilizador de Dirección Sistema Sencillo	
F	86-95	TOYOTA PICKUP Todos Estabilizador de Dirección Sistema Sencillo	
F	79-85	PICKUP 4x2 Tracción trasera Estabilizador de Dirección Sistema Sencillo	
6803SE	D		141998
F	69-72	CHEVROLET BLAZER Todos Estabilizador de Dirección Sistema Sencillo	
F	60	PICKUP Truck Eje Dana 60 hasta 3 1/2" de Ø ext. o Eje Napco hasta 3 3/8" de Ø ext.	
F	57-58	PICKUP Truck Eje Dana 60 hasta 3 1/2" de Ø ext. o Eje Napco hasta 3 3/8" de Ø ext.	
F	61-72	PICKUP 1/2 TON, K10 Todos Estabilizador de Dirección Sistema Sencillo	
F	61-72	PICKUP 3/4 TON, K20 Todos Estabilizador de Dirección Sistema Sencillo	
F	01-09	PICKUP 3/4 TON, SILVERADO 2500 HD Todos 9200# PBV sin Unidad de EO - 15059138 15155638	
F	68-72	SUBURBAN 1/2 TON, K10 Todos Estabilizador de Dirección Sistema Sencillo	
F	68-72	SUBURBAN 3/4 TON, K20 Todos Estabilizador de Dirección Sistema Sencillo	
F	70	DODGE A100 TRUCK Todos Estabilizador de Dirección Sistema Sencillo c/ Eje de Viga en I	
F	60-89	PICKUP 1/2 TON, W100 SERIES Todos Estabilizador de Dirección Sistema Sencillo	
F	60-89	PICKUP 1 TON, W300 SERIES Todos Estabilizador de Dirección Sistema Sencillo	
F	69-89	PICKUP 3/4 TON, W200 SERIES Todos Estabilizador de Dirección Sistema Sencillo	
F	60-67	PICKUP 3/4 TON, W200 SERIES Todos Estabilizador de Dirección Sistema Sencillo	
F	75-93	RAMCHARGER 4x4 Estabilizador de Dirección Sistema Sencillo	
F	74	RAMCHARGER Todos Estabilizador de Dirección Sistema Sencillo	

Lista numérica

Amort.	POP	No. Alternativo	Montaje Accesorio
Pos.	Año	Aplicación	
6803SE	D	-continued	141998
F	71-87	VAN 1/2 TON, A / B SERIES / RAM Todos Estabilizador de Dirección Sistema Sencillo	
F	71-87	VAN 1 TON, A / B SERIES / RAM Todos Estabilizador de Dirección Sistema Sencillo	
F	80-87	VAN 3/4 TON, A / B SERIES / RAM Todos Estabilizador de Dirección Sistema Sencillo	
F	78-79	VAN 3/4 TON, A / B SERIES / RAM Todos Van Charger Special	
F	71-77	VAN 3/4 TON, A / B SERIES / RAM Todos Estabilizador de Dirección Sistema Sencillo	
F	70-79	FORD BRONCO Todos Estabilizador de Dirección Sistema Sencillo	
F	59	F SERIES Todos Estabilizador de Dirección Sistema Sencillo F-250, F-350 sin Power Steering	
F	77-79	PICKUP 1/2 TON, F-100 Todos Estabilizador de Dirección Sistema Sencillo 4x4	
F	75-76	PICKUP 1/2 TON, F-100 4x4 Estabilizador de Dirección Sistema Sencillo	
F	76-79	PICKUP 1/2 TON, F-150 4x4 Estabilizador de Dirección Sistema Sencillo	
F	75	PICKUP 1/2 TON, F-150 Todos 4x4	
F	75-77	PICKUP 1 TON, F-350 / SUPERDUTY Manual Steering Estabilizador de Dirección Sistema Sencillo	
F	75-77	PICKUP 3/4 TON, F-250 / SUPERDUTY 4x4, Manual Steering Estabilizador de Dirección Sistema Sencillo	
F	74-79	VAN 3/4 TON, ECONOLINE / CLUB WAGON / SUPERDUTY Todos QuadraVan Special	
F	70-72	GMC JIMMY 4x4 Estabilizador de Dirección Sistema Sencillo K-5	
F	69-72	PICKUP 1/2 TON, K15 / K1500 Todos Estabilizador de Dirección Sistema Sencillo	
F	67-72	PICKUP 3/4 TON, K25 / K2500 Todos Estabilizador de Dirección Sistema Sencillo	
F	68-72	SUBURBAN 1/2 TON, K15 / K1500 Todos Estabilizador de Dirección Sistema Sencillo	
F	68-72	SUBURBAN 3/4 TON, K25 / K2500 Todos Estabilizador de Dirección Sistema Sencillo	
F	69-71	INTERNATIONAL SCOUT Todos Estabilizador de Dirección Sistema Sencillo	
F	71-80	SCOUT II Todos Estabilizador de Dirección Sistema Sencillo	
F	75	TRAVELALL 4x4 Estabilizador de Dirección Sistema Sencillo	
F	63-67	JEEP GLADIATOR Todos Estabilizador de Dirección Sistema Sencillo	
F	75-81	PLYMOUTH TRAILDUSTER 4x4 Estabilizador de Dirección Sistema Sencillo	
F	74	TRAILDUSTER Todos Estabilizador de Dirección Sistema Sencillo	
F	84-85	TOYOTA 4RUNNER Todos Estabilizador de Dirección Sistema Sencillo	
F	80-85	PICKUP 4x4 Estabilizador de Dirección Sistema Sencillo c/ Montajes de EO	
6804SE	B	-continued	500498,141397
F	80-88	AMERICAN MOTORS EAGLE Todos	
F	75-86	CHEVROLET BLAZER 4x4 Estabilizador de Dirección Sistema Sencillo	
F	75-84	BLAZER 4x2 Tracción trasera Estabilizador de Dirección Sistema Sencillo	
F	73-86	PICKUP 1/2 TON, K10 Todos Estabilizador de Dirección Sistema Sencillo	
F	87	PICKUP 1/2 TON, V10 Todos Estabilizador de Dirección Sistema Sencillo	

Amortiguadores de Dirección

Amort.	POP	No. Alternativo	Montaje Accesorio
Pos.	Año	Aplicación	
6804SE	B	-continued	500498,141397
F	77-86	PICKUP 1 TON, K30 Todos Estabilizador de Dirección Sistema Sencillo	
F	73-86	PICKUP 3/4 TON, K20 Todos Estabilizador de Dirección Sistema Sencillo	
F	87	PICKUP 3/4 TON, V20 Todos Estabilizador de Dirección Sistema Sencillo	
F	73-86	SUBURBAN 1/2 TON, K10 Todos Estabilizador de Dirección Sistema Sencillo	
F	87-88	SUBURBAN 1/2 TON, R10 Todos Estabilizador de Dirección Sistema Sencillo	
F	73-86	SUBURBAN 3/4 TON, K20 Todos Estabilizador de Dirección Sistema Sencillo	
F	87-88	SUBURBAN 3/4 TON, V20 Todos Estabilizador de Dirección Sistema Sencillo	
F	89-91	SUBURBAN 3/4 TON, V2500 Todos Estabilizador de Dirección Sistema Sencillo	
F	94-95	VAN 1 TON, G / EXPRESS Todos Estabilizador de Dirección Sistema Sencillo HD c/ Eje Delantero Rígido y Tilt Hood	
F	85-93	VAN 1 TON, P SERIES Todos Estabilizador de Dirección Sistema Sencillo c/ Suspensión Delantera de Viga en I	
F	87-94	DODGE DAKOTA 4x4 Estabilizador de Dirección Sistema Sencillo	
F	94-97	PICKUP 1/2 TON, RAM 1500 4x4 Con Número de EO 52038276	
F	94-97	PICKUP 1 TON, RAM 3500 4x4 Con Número de EO 52038276	
F	94-97	PICKUP 3/4 TON, RAM 2500 4x4 Con Número de EO 52038276	
F	66-69	FORD BRONCO Todos Estabilizador de Dirección Sistema Sencillo	
F	73-91	GMC JIMMY Todos Amortiguador de reemplazo HD para vehículos con estabilizador de EO	
F	73-86	PICKUP 1/2 TON, K15 / K1500 Todos Estabilizador de Dirección Sistema Sencillo	
F	87	PICKUP 1/2 TON, V1500 Todos Estabilizador de Dirección Sistema Sencillo	
F	73-86	PICKUP 3/4 TON, K25 / K2500 Todos Estabilizador de Dirección Sistema Sencillo	
F	87	PICKUP 3/4 TON, V2500 Todos Estabilizador de Dirección Sistema Sencillo	
F	73-86	SUBURBAN 1/2 TON, K15 / K1500 Todos Estabilizador de Dirección Sistema Sencillo	
F	87-91	SUBURBAN 1/2 TON, V1500 Todos Estabilizador de Dirección Sistema Sencillo	
F	73-86	SUBURBAN 3/4 TON, K25 / K2500 Todos Estabilizador de Dirección Sistema Sencillo	
F	87-91	SUBURBAN 3/4 TON, V2500 Todos Estabilizador de Dirección Sistema Sencillo	
F	94-95	VAN 1 TON, G / SAVANNA Todos Estabilizador de Dirección Sistema Sencillo HD c/ Eje Delantero Rígido y Tilt Hood	
F	75-83	JEEP CHEROKEE 4x4 Estabilizador de Dirección Sistema Sencillo	
F	74	CHEROKEE Todos Estabilizador de Dirección Sistema Sencillo	
F	84-91	GRAND WAGONEER Todos Estabilizador de Dirección Sistema Sencillo	
F	74-88	J10 PICKUP Todos Estabilizador de Dirección Sistema Sencillo	
F	74-88	J20 PICKUP Todos Estabilizador de Dirección Sistema Sencillo	
F	86-95	TOYOTA PICKUP 4x4 Estabilizador de Dirección Sistema Sencillo c/ Montajes de EO	
6805SE	D	-continued	141397,141998,142000
F	75-93	CHEVROLET VAN 1 TON, P SERIES Todos Chasis Motorhome	

Lista numérica

Amort.	POP	No. Alternativo	Montaje Accesorio
Pos.	Año	Aplicación	
6805SE	D	-continued	141397,141998,142000
F	79	FORD PICKUP 1 TON, F-350 / SUPERDUTY 4x4, Power Steering Estabilizador de Dirección Sistema Sencillo	
F	77-79	PICKUP 3/4 TON, F-250 / SUPERDUTY 4x4, Power Steering Estabilizador de Dirección Sistema Sencillo	
F	79-93	GMC VAN 1 TON, P SERIES Todos Step Van Forward Control y Motorhome	
F	75-78	VAN 1 TON, P SERIES Todos Chasis Motorhome	
6807SE	B	-continued	142038,500498
F	88-99	CHEVROLET PICKUP 1/2 TON, K15 / K1500 Todos Estabilizador de Dirección Sistema Sencillo	
F	91-03	PICKUP 1 TON, C35/3500 Todos Estabilizador de Dirección Sistema Sencillo Pickup HD	
F	88-00	PICKUP 1 TON, K35 / K3500 Todos Estabilizador de Dirección Sistema Sencillo	
F	88-99	PICKUP 3/4 TON, K25 / K2500 Todos Estabilizador de Dirección Sistema Sencillo	
F	92-97	SUBURBAN 1/2 TON, K15 / K1500 Todos Estabilizador de Dirección Sistema Sencillo	
F	92-97	SUBURBAN 3/4 TON, K25 / K2500 Todos Estabilizador de Dirección Sistema Sencillo	
F	88-99	GMC PICKUP 1/2 TON, K15 / K1500 Todos Estabilizador de Dirección Sistema Sencillo	
F	91-93	PICKUP 1 TON, C35/3500 Todos Estabilizador de Dirección Sistema Sencillo Pickup HD	
F	88-99	PICKUP 1 TON, K35 / K3500 Todos Estabilizador de Dirección Sistema Sencillo	
F	88-99	PICKUP 3/4 TON, K25 / K2500 Todos Estabilizador de Dirección Sistema Sencillo	
F	92-95	SUBURBAN 1/2 TON, K15 / K1500 Todos Estabilizador de Dirección Sistema Sencillo	
F	92-97	SUBURBAN 3/4 TON, K25 / K2500 Todos Estabilizador de Dirección Sistema Sencillo	
6826SE	D	-continued	141998 x 2
F	95-97	FORD PICKUP 1 TON, F-350 / SUPERDUTY 4x4	
6828SE	C	-continued	142718
F	99-06	FORD PICKUP 1 TON, F-350 / SUPERDUTY 4x2 Tracción trasera	
F	99-06	PICKUP 3/4 TON, F-250 / SUPERDUTY 4x2 Tracción trasera	
6846SE	C	-continued	
F	97-99	DODGE PICKUP 1/2 TON, RAM 1500 4x4 Con Número de EO 52039280	
F	97-99	PICKUP 1 TON, RAM 3500 4x4 Con Número de EO 52039280	
F	97-99	PICKUP 3/4 TON, RAM 2500 4x4 Con Número de EO 52039280	
6847SE	C	-continued	
F	00-07	DODGE PICKUP 1/2 TON, RAM 1500 4x4 Con Número de EO 52106909AB, AC, AD	
F	00-07	PICKUP 1 TON, RAM 3500 4x4 Con Número de EO 52106909AB, AC, AD	
F	00-07	PICKUP 1 TON, RAM 3500 4x2 Tracción trasera Con Número de EO 52106909AB, AC, AD w/Eje Delantero Rígido	
F	00-07	PICKUP 3/4 TON, RAM 2500 4x4 Con Número de EO 52106909AB, AC, AD	
6848SE	D	-continued	143163
F	87-95	NISSAN PATHFINDER 4x4	
F	84-97	PICKUP	
6850SE	D	-continued	143168
F	99-04	FORD PICKUP 1 TON, F-350 / SUPERDUTY 4x4 Exc. Unidad de EO	

Lista numérica

Amort.	POP	No. Alternativo	Montaje Accesorio
Pos.	Año	Aplicación	
6850SE	D	-continued	143168
F	99-04	PICKUP 3/4 TON, F-250 / SUPERDUTY 4x4 Exc. Unidad de EO	
6851SE	W		143177, 140629
F	83-04	CHEVROLET S10 4x4 Estabilizador de Dirección Sistema Sencillo; sin orificio de montaje de EO en brazo de dirección	
F	83-04	GMC JIMMY 4x4, Power Steering Estabilizador de Dirección Sistema Sencillo; sin orificio de montaje de EO en brazo de dirección	
F	83-90	SONOMA / S15 4x4, Power Steering Estabilizador de Dirección Sistema Sencillo; sin orificio de montaje de EO en brazo de dirección	
F	92-93	TYPHOON Todos Estabilizador de Dirección Sistema Sencillo; sin orificio de montaje de EO en brazo de dirección	
6852SE	D		143165
F	92-99	CHEVROLET SUBURBAN 1/2 TON, C15 / C1500 4x2 Tracción trasera	
F	92-99	SUBURBAN 3/4 TON, C25 / C2500 4x2 Tracción trasera	
F	95-99	TAHOE 4x2 Tracción trasera	
F	88-99	GMC PICKUP 1/2 TON, C15 / C1500 4x2 Tracción trasera	
F	92-99	PICKUP 3/4 TON, C25 / C2500 4x2 Tracción trasera Exc. Estabilizador de Dirección de EO	
F	88-91	PICKUP 3/4 TON, C25 / C2500 4x2 Tracción trasera	
F	92-99	SUBURBAN 1/2 TON, C15 / C1500 4x2 Tracción trasera Exc. Estabilizador de Dirección de EO	
F	95-99	YUKON 4x2 Tracción trasera	
6853SE	B		143155
F	92-99	CHEVROLET PICKUP 1/2 TON, C15 / C1500 Todos Exc. Estabilizador de Dirección de EO	
F	92-97	PICKUP 1/2 TON, K15 / K1500 Todos Exc. Estabilizador de Dirección de EO	
F	95-00	PICKUP 1 TON, K35 / K3500 Todos Exc. Estabilizador de Dirección de EO	
F	92-99	PICKUP 3/4 TON, C25 / C2500 Todos Exc. Estabilizador de Dirección de EO	
F	99-00	PICKUP 3/4 TON, K25 / K2500 Todos Exc. Estabilizador de Dirección de EO	
F	01-09	PICKUP 3/4 TON, SILVERADO 2500 HD 4x4 PBV 9200 con Amortiguador de EO 15059138, 15155638	
F	00-05	SUBURBAN 1/2 TON, 1500 4x4 Exc. Estabilizador de Dirección de EO	
F	00-05	SUBURBAN 3/4 TON, 2500 4x4 Exc. Estabilizador de Dirección de EO	
F	95-99	SUBURBAN 3/4 TON, K25 / K2500 Todos Exc. Estabilizador de Dirección de EO	
F	01-05	TAHOE 4x4 Estilo New Body, Exc. Suspensión Z55	
F	95-00	TAHOE 4x4 Old Body Style	
F	99-00	GMC PICKUP 3/4 TON, K25 / K2500 4x4 PBV 9200 con Amortiguador de EO 15059138, 15155638	
F	99-05	SIERRA 1500 4x4 Exc. Estabilizador de Dirección de EO	
F	99-04	SIERRA 2500 4x4 Hasta PBV 8600#, Exc. Estabilizador de Dirección de EO	
F	01-09	SIERRA 2500 HD 4x4 PBV 9200 con Amortiguador de EO 15059138, 15155638	
F	99-05	YUKON 4x4	
F	93-98	JEEP GRAND CHEROKEE Todos	
6854SE	D		142718
F	00-05	FORD EXCURSION 4x4 Con Amortiguador de EO	
F	99-03	PICKUP 1 TON, F-350 / SUPERDUTY 4x4 Con Amortiguador de EO	

Amortiguadores de Dirección

Amort.	POP	No. Alternativo	Montaje Accesorio
Pos.	Año	Aplicación	
6854SE	D	-continued	142718
F	99-03	PICKUP 3/4 TON, F-250 / SUPERDUTY 4x4 Con Amortiguador de EO	
F	01-04	PICKUP, F-450 SUPERDUTY 4 X 4	
F	99-00	PICKUP, F-450 SUPERDUTY 4 X 4 Con Amortiguador de EO	
F	99-04	PICKUP, F-550 SUPERDUTY 4 X 4	
6855SE	D		143154
F	99-04	FORD PICKUP 1 TON, F-350 / SUPERDUTY 4x4 Kit de Reemplazo	
F	99-04	PICKUP 3/4 TON, F-250 / SUPERDUTY 4x4 Kit de Reemplazo	
6856SE	D		143156, 143077
F	05-07	FORD PICKUP 3/4 TON, F-250 / SUPERDUTY 4x4 Exc. Estabilizador de Dirección de EO	
6857SE	D		143157
F	93-97	FORD PICKUP 1/2 TON, F SUPERDUTY Todos Con Amortiguador de EO	
6858SE	D		143161
F	95-01	FORD VAN 1/2 TON, ECONOLINE / CLUB WAGON Todos Kit de Repuesto	
F	95-01	VAN 1 TON, ECONOLINE / CLUB WAGON / SUPERDUTY Todos Kit de Repuesto	
F	95-01	VAN 3/4 TON, ECONOLINE / CLUB WAGON / SUPERDUTY Todos Kit de Repuesto	
6859SE	D		143166
F	94-01	DODGE PICKUP 1/2 TON, RAM 1500 4x2 Tracción trasera, GAS Estabilizador de Dirección para Suspensión con Resortes Helicoidales	
F	94-02	PICKUP 1 TON, RAM 3500 4x2 Tracción trasera, GAS Estabilizador de Dirección para Suspensión con Resortes Helicoidales	
F	94-02	PICKUP 3/4 TON, RAM 2500 4x2 Tracción trasera, GAS Estabilizador de Dirección para Suspensión con Resortes Helicoidales	
6860SE	D		143162
F	97-04	FORD LOBO PICK UP	
F	97-03	PICKUP 1/2 TON, F-150 4x2 Tracción trasera, Coil (FrontSpringType)	
F	97-99	PICKUP 3/4 TON, F-250 / SUPERDUTY 4x2 Tracción trasera, Coil (FrontSpringType)	
6861SE	D		143160
F	97-02	FORD EXPEDITION 4x4, Barra de Torsion (FrontSpringType)	
F	97-03	LOBO PICK UP	
F	97-03	PICKUP 1/2 TON, F-150 4x4	
F	97-99	PICKUP 3/4 TON, F-250 / SUPERDUTY 4x4, Barra de Torsion (FrontSpringType)	
6863SE	X		143164
F	98	NISSAN FRONTIER 4x4	
14004	D		
F	59-77	VOLKSWAGEN BEETLE	
F	59-77	BEETLE Todos	
F	73-80	SAFARI	
F	89-02	SEDAN	
F	73-87	SEDAN	
F	73-74	THING	
F	73-74	THING Todos	
14005	FF		
F	71-75	VOLKSWAGEN SUPER BEETLE Todos	
14010	W		
F	67-78	CADILLAC ELDORADO Todos	
F	71-78	OLDSMOBILE TORONADO Todos	
F	66	TORONADO Todos	
14016	D		140126 x 2
F	71-79	FORD BRONCO Todos	
F	67	BRONCO Todos	
F	79	PICKUP 1/2 TON, F-100 Todos Sistema Sencillo 4x4	
F	77-78	PICKUP 1/2 TON, F-100 Todos 4x4	
F	75-76	PICKUP 1/2 TON, F-100 4x4	

Lista numérica

Amort.	POP	No. Alternativo	Montaje Accesorio
Pos.	Año	Aplicación	
14016	D	-continued	140126 x 2
F	76-79	PICKUP 1/2 TON, F-150 4x4 4x4	
F	75	PICKUP 1/2 TON, F-150 Todos 4x4	
14017	D		142387
F	87-91	CHEVROLET BLAZER 4x4 Full Size	
F	75-86	BLAZER 4x4	
F	75-84	BLAZER 4x2 Tracción trasera	
F	73-86	PICKUP 1/2 TON, K10 Todos	
F	87	PICKUP 1/2 TON, V10 Todos	
F	77-86	PICKUP 1 TON, K30 Todos	
F	73-74	PICKUP 1 TON, K30 Todos	
F	89-91	PICKUP 1 TON, R3500 Todos	
F	87-88	PICKUP 1 TON, V3000 Todos	
F	89-91	PICKUP 1 TON, V3000 / V3500 Todos	
F	73-86	PICKUP 3/4 TON, K20 Todos	
F	87	PICKUP 3/4 TON, V20 Todos	
F	73-86	SUBURBAN 1/2 TON, K10 Todos	
F	87-88	SUBURBAN 1/2 TON, R10 Todos	
F	73-86	SUBURBAN 3/4 TON, K20 Todos	
F	87-88	SUBURBAN 3/4 TON, V20 Todos	
F	89-91	SUBURBAN 3/4 TON, V2500 Todos	
F	73-91	GMC JIMMY Todos Amortiguador de reemplazo para vehiculos con estabilizador de EO	
F	73-86	PICKUP 1/2 TON, K15 / K1500 Todos	
F	87	PICKUP 1/2 TON, V1500 Todos	
F	77-86	PICKUP 1 TON, K35 / K3500 Todos	
F	73-74	PICKUP 1 TON, K35 / K3500 Todos	
F	87-91	PICKUP 1 TON, V3000 / V3500 Todos	
F	73-86	PICKUP 3/4 TON, K25 / K2500 Todos	
F	87	PICKUP 3/4 TON, V2500 Todos	
F	73-86	SUBURBAN 1/2 TON, K15 / K1500 Todos	
F	87-91	SUBURBAN 1/2 TON, V1500 Todos	
F	73-86	SUBURBAN 3/4 TON, K25 / K2500 Todos	
F	87-91	SUBURBAN 3/4 TON, V2500 Todos	
14018	W		141264
F	76-79	CADILLAC SEVILLE Todos	
14019	W		141264
F	87-92	CADILLAC BROUHAM Todos	
F	92-96	COMMERCIAL CHASSIS 4x2 Tracción trasera	
F	77-84	COMMERCIAL CHASSIS Todos	
F	93-96	FLEETWOOD 4x2 Tracción trasera 4x2 Tracción trasera	
F	87-92	FLEETWOOD Todos 4x2 Tracción trasera	
F	85-86	FLEETWOOD 4x2 Tracción trasera 4x2 Tracción trasera	
F	73-77	CHEVROLET EL CAMINO Todos	
F	73-77	MONTE CARLO Todos	
F	73-77	GMC SPRINT / CABALLERO Todos	
14020	X		141264
F	79-85	BUICK RIVIERA Todos	
F	79-85	CADILLAC ELDORADO Todos	
F	80-85	SEVILLE Todos	
F	79-85	OLDSMOBILE TORONADO Todos	
14039	D		
F	84-04	FORD MUSTANG / MUSTANG II Todos	
F	84-88	THUNDERBIRD Todos	
F	84-86	MERCURY CAPRI Todos	
F	84-88	COUGAR Todos	
14040	A		500498
F	84-01	JEEP CHEROKEE Todos	
F	86-92	COMANCHE Todos	
14071	A		
F	99-04	JEEP GRAND CHEROKEE Todos Amortiguador de Dirección Sistema Sencillo	
14072	N		
F	08-10	FORD PICKUP 1 TON, F-350 / SUPERDUTY 4x4	
F	08-10	PICKUP 3/4 TON, F-250 / SUPERDUTY 4x4	
F	08-10	PICKUP, F-450 SUPERDUTY 4 X 4	
F	08-10	PICKUP, F-550 SUPERDUTY 4 X 4	
14073	FF		
F	80-95	TOYOTA LAND CRUISER Todos	
14074	FF		
F	07-13	JEEP WRANGLER 4x4	

Lista numérica

Amortiguadores de Dirección, Amortiguadores de Carga Traseros

Lista numérica

Amort.	POP	No. Alternativo	Montaje Accesorio
Pos.	Año	Aplicación	
14075	FF		
F	11-13	CHEVROLET PICKUP 1 TON, SILVERADO 3500 HD Todos	
F	11-13	PICKUP 3/4 TON, SILVERADO 2500 HD Todos	
F	11-13	GMC SIERRA 2500 HD Todos	
F	11-13	SIERRA 3500 HD Todos	

Amort.	POP	No. Alternativo	Montaje Accesorio
Pos.	Año	Aplicación	
14077	D		
F	95-02	FORD EXPLORER 4x4	

Amortiguadores de Carga Traseros

Amort.	POP	No. Alternativo	Montaje Accesorio
Pos.	Año	Aplicación	
34036	W		140357
F	75-84	CHEVROLET BLAZER 4x2 Tracción trasera	
F	69-74	BLAZER Todos 4x2 Tracción trasera	
F	63-86	PICKUP 1/2 TON, C10 Todos	
F	87	PICKUP 1/2 TON, R10 Todos	
F	63-86	PICKUP 1 TON, C30 Todos	
F	88-91	PICKUP 1 TON, C35/3500 Cab & Chassis	
F	87-88	PICKUP 1 TON, R30 Todos	
F	89	PICKUP 1 TON, R3500 Standard Cab Pickup	
F	75-86	PICKUP 3/4 TON, C20 Crew Cab Pickup	
F	75-86	PICKUP 3/4 TON, C20 Standard Cab Pickup	
F	63-74	PICKUP 3/4 TON, C20 Todos	
F	87-88	PICKUP 3/4 TON, R20 Crew Cab Pickup	
F	89	PICKUP 3/4 TON, R2500 4x2 Tracción trasera	
F	63-66	SUBURBAN 1/2 TON, 1500 Todos	
F	67-86	SUBURBAN 1/2 TON, C10 Todos	
F	87-88	SUBURBAN 1/2 TON, R10 Todos	
F	89-91	SUBURBAN 1/2 TON, R1500 Todos	
F	67-86	SUBURBAN 3/4 TON, C20 Todos	
F	87-88	SUBURBAN 3/4 TON, R20 Todos	
F	89-91	SUBURBAN 3/4 TON, R2500 Todos	
F	63-80	VAN 1/2 TON, P SERIES Todos	
F	73-90	VAN 1 TON, P SERIES Todos Exc. Chasis Motorhome	
F	68-72	VAN 1 TON, P SERIES Todos	
F	68-89	VAN 3/4 TON, P SERIES Todos	
F	75-84	GMC JIMMY 4x2 Tracción trasera	
F	70-74	JIMMY Todos 4x2 Tracción trasera	
F	67-86	PICKUP 1/2 TON, C15 / C1500 Todos	
F	87	PICKUP 1/2 TON, R1500 Todos	
F	91	PICKUP 1 TON, C35/3500 Cab & Chassis Eje Delantero Rígido HD	
F	88-90	PICKUP 1 TON, C35/3500 Cab & Chassis	
F	67-78	PICKUP 1 TON, C35/3500 Todos	
F	87-91	PICKUP 1 TON, R3500 Todos	
F	85-86	PICKUP 3/4 TON, C25 / C2500 Crew Cab Pickup	
F	75-86	PICKUP 3/4 TON, C25 / C2500 Cab & Chassis	
F	75-86	PICKUP 3/4 TON, C25 / C2500 Standard Cab Pickup	
F	75-83	PICKUP 3/4 TON, C25 / C2500 Crew Cab Pickup	
F	67-74	PICKUP 3/4 TON, C25 / C2500 Todos	
F	87-89	PICKUP 3/4 TON, R2500 Todos Exc. Crew Cab y Bonus Cab	
F	63-65	PICKUP 1000 SERIES Todos	
F	63-65	PICKUP 1500 SERIES Todos	
F	68-86	SUBURBAN 1/2 TON, C15 / C1500 Todos	
F	87-91	SUBURBAN 1/2 TON, R1500 Todos	
F	68-86	SUBURBAN 3/4 TON, C25 / C2500 Todos	
F	87-91	SUBURBAN 3/4 TON, R2500 Todos	
F	67-80	VAN 1/2 TON, P SERIES Todos	
F	75-90	VAN 1 TON, P SERIES Todos Exc. Chasis Motorhome	
F	74	VAN 1 TON, P SERIES Base Exc. Chasis Motorhome	
F	73	VAN 1 TON, P SERIES Todos Exc. Chasis Motorhome	
F	68-72	VAN 1 TON, P SERIES Todos	
F	68-89	VAN 3/4 TON, P SERIES Todos	
F	63-65	VAN, PB 1000 SERIES Todos	

Amort.	POP	No. Alternativo	Montaje Accesorio
Pos.	Año	Aplicación	
34051	D		140455
F	73-75	BUICK APOLLO Todos	
F	73-81	CENTURY Todos	
F	73-87	REGAL Todos	
F	75-79	SKYLARK Todos	
F	69-72	SKYLARK Todos	
F	68	SKYLARK Todos Suspensión HD Exc. Sportwagon	

Amort.	POP	No. Alternativo	Montaje Accesorio
Pos.	Año	Aplicación	
34051	D	-continued	140455
F	68-69	SPECIAL Todos	
F	68-72	SPORTWAGON Todos	
F	76-79	CADILLAC SEVILLE Todos	
F	05	CHEVROLET BLAZER Base, 4x2 Tracción trasera	
F	96-04	BLAZER LS, 4x2 Tracción trasera	
F	95-02	BLAZER LT, 4x2 Tracción trasera	
F	95-99	BLAZER Base, 4x2 Tracción trasera	
F	95-97	BLAZER Deluxe, 4x2 Tracción trasera	
F	83-94	BLAZER, S MODELS 4x2 Tracción trasera	
F	68-73	CHEVELLE Todos	
F	68-87	EL CAMINO Todos	
F	73-83	MALIBU Todos	
F	70-88	MONTE CARLO Todos	
F	69-79	NOVA Todos	
F	94-03	S10 LS, 4x2 Tracción trasera	
F	83-03	S10 Base, 4x2 Tracción trasera	
F	92-93	S10 EL, 4x2 Tracción trasera	
F	83-92	S10 Tahoe, 4x2 Tracción trasera	
F	88-90	S10 Durango, 4x2 Tracción trasera	
F	83-86	S10 Durango, 4x2 Tracción trasera	
F	82	S10 Base	
F	82	S10 Durango	
F	92-04	GMC JIMMY 4x2 Tracción trasera	
F	83-91	S15 JIMMY 4x2 Tracción trasera	
F	04	SONOMA / S15 Todos 4x2 Tracción trasera	
F	82-03	SONOMA / S15 4x2 Tracción trasera	
F	78-87	SPRINT / CABALLERO Todos	
F	77	SPRINT / CABALLERO 4x2 Tracción trasera	
F	75-76	SPRINT / CABALLERO Todos	
F	71-74	SPRINT / CABALLERO 4x2 Tracción trasera	
F	98-00	ISUZU HOMBRE 4x2 Tracción trasera Exc. Chasis Deportivo	
F	96-97	HOMBRE Todos Exc. Chasis Deportivo	
F	68-87	OLDSMOBILE CUTLASS / CUTLASS SUPREME Todos	
F	80-83	CUTLASS CLASSIC / CUTLASS CRUISER Todos	
F	78-79	OMEGA Todos	
F	82-86	PONTIAC BONNEVILLE Todos	
F	78-80	GRAND AM Todos	
F	73-75	GRAND AM Todos	
F	75-83	GRAND LEMANS Todos	
F	69-87	GRAND PRIX Todos	
F	71-75	GRANDVILLE Todos	
F	68-81	LEMANS Todos	
F	77-79	PHOENIX Todos	
F	73-77	VENTURA Todos	

Amort.	POP	No. Alternativo	Montaje Accesorio
Pos.	Año	Aplicación	
34052	W		140126
F	84-86	DODGE MINI RAM Todos	
F	72-93	PICKUP 1/2 TON, D100 SERIES Todos	
F	72-93	PICKUP 3/4 TON, D200 SERIES Todos Exc. Paquete HD	
F	75-93	RAMCHARGER 4x2 Tracción trasera	
F	99-03	VAN 1/2 TON, A / B SERIES / RAM 109.3 (WheelBase) Exc. PBV 7000#	
F	82-98	VAN 1/2 TON, A / B SERIES / RAM 109.6 (WheelBase) Exc. PBV 7000#	
F	71-80	VAN 1/2 TON, A / B SERIES / RAM Todos	
F	99-03	VAN 1 TON, A / B SERIES / RAM Todos	
F	71-98	VAN 1 TON, A / B SERIES / RAM Todos Exc. Eje Delantero 4000#	
F	71-03	VAN 3/4 TON, A / B SERIES / RAM Todos	
F	78-80	VAN, CB300 Todos Exc. Eje Delantero 4000#	
F	74-77	VAN, CB300 Todos Hasta PBV 8300#	
F	81	PLYMOUTH TRAILDUSTER Todos	
F	75-80	TRAILDUSTER 4x2 Tracción trasera	
F	74-83	VAN 1/2 TON, PB SERIES Todos	
F	74-83	VAN 1 TON, PB SERIES Todos Exc. Eje Delantero 4000#	
F	74-83	VAN 3/4 TON, PB SERIES Todos	

Amort.	POP	No. Alternativo	Montaje Accesorio
Pos.	Año	Aplicación	
34057	W	-continued	140780
F	84-88	BRONCO II Todos Con Perno de 10mm en Montaje Inferior Trasero	
F	80-83	PICKUP 1/2 TON, F-100 4x2 Tracción trasera	
F	80-96	PICKUP 1/2 TON, F-150 4x4 Con o sin Suspensión Quad detrás del Eje Delantero; Exc. Kit de Levantamiento	
F	80-96	PICKUP 1/2 TON, F-150 4x2 Tracción trasera	
F	87-89	RANGER Todos Exc. Opción High Ryder	
F	83-86	RANGER Todos	

Amort.	POP	No. Alternativo	Montaje Accesorio
Pos.	Año	Aplicación	
34058	W		140780
F	66-77	FORD BRONCO Todos Desde Serie #830001; Exc. Kit de Levantamiento	
F	73-79	PICKUP 1/2 TON, F-100 4x2 Tracción trasera	
F	75-79	PICKUP 1/2 TON, F-150 4x2 Tracción trasera	
F	75-79	PICKUP 1 TON, F-350 / SUPERDUTY 4x2 Tracción trasera	
F	75-79	PICKUP 3/4 TON, F-250 / SUPERDUTY 4x2 Tracción trasera	
F	77-91	VAN 1 TON, ECONOLINE / CLUB WAGON / SUPERDUTY Todos	
F	75-91	VAN 1 TON, ECONOLINE / CLUB WAGON / SUPERDUTY Todos Exc. Conversión Motorhome	
F	75-91	VAN 3/4 TON, ECONOLINE / CLUB WAGON / SUPERDUTY Todos	

Amort.	POP	No. Alternativo	Montaje Accesorio
Pos.	Año	Aplicación	
34073	W		141041
F	71-73	BUICK CENTURION Todos	
F	85-89	ELECTRA Estate Wagon	
F	71-84	ELECTRA Todos	
F	71-83	ESTATE WAGON Todos	
F	88-89	LESABRE Todos	
F	71-85	LESABRE Todos	
F	71-78	RIVIERA Todos	
F	91-96	ROADMASTER Todos	
F	87-92	CADILLAC BROUGHAM Todos	
F	92-96	COMMERCIAL CHASSIS 4x2 Tracción trasera	
F	77-84	COMMERCIAL CHASSIS Todos	
F	77-84	DEVILLE Todos	
F	93-96	FLEETWOOD Todos	
F	77-86	FLEETWOOD 4x2 Tracción trasera	
F	81	CHEVROLET BEL AIR Todos	
F	75	BEL AIR Sedan	
F	65-74	BEL AIR Todos	
F	65-72	BISCAYNE Todos	
F	69-72	BROOKWOOD Todos	
F	70-81	CAMARO Todos	
F	66-96	CAPRICE Todos	
F	94-96	IMPALA Todos	
F	83-85	IMPALA Todos	
F	82	IMPALA Sedan	
F	65-81	IMPALA Todos	
F	69-72	KINGSWOOD Todos	
F	69-72	TOWNSMAN Todos	
F	65-74	FORD COUNTRY SEDAN Todos	
F	87-91	COUNTRY SQUIRE Todos	
F	65-74	COUNTRY SQUIRE Todos	
F	92-02	CROWN VICTORIA Todos Exc. Sistema de Autonivelación NIVOMAT	
F	65-72	CUSTOM Todos	
F	68-77	CUSTOM 500 Todos	
F	65-67	GALAXIE Todos	
F	68-74	GALAXIE 500 Todos	
F	84-94	GHIA	
F	01-02	GRAND MARQUIS Todos	
F	87-91	LTD / COUNTRY SEDAN / COUNTRY SQUIRE / CROWN VICTORIA Todos	
F	67-82	LTD / COUNTRY SEDAN / COUNTRY SQUIRE / CROWN VICTORIA Todos	
F	77-79	LTD II Todos	
F	72-79	RANCHERO Todos	
F	65-74	RANCH WAGON Todos	
F	67-79	THUNDERBIRD Todos	
F	72-76	TORINO Todos	
F	70-80	LINCOLN CONTINENTAL Todos	
F	68-71	MARK III Todos	
F	72-76	MARK IV Todos	
F	77-79	MARK V Todos	
F	80-83	MARK VI Todos	
F	81-02	TOWN CAR Todos	
F	67	MERCURY BROUGHAM Todos	
F	87-91	COLONY PARK Todos	
F	65-74	COLONY PARK Todos	

Amort.	POP	No. Alternativo	Montaje Accesorio
Pos.	Año	Aplicación	
34073	W		141041
F	71-73	BUICK CENTURION Todos	
F	85-89	ELECTRA Estate Wagon	
F	71-84	ELECTRA Todos	
F	71-83	ESTATE WAGON Todos	
F	88-89	LESABRE Todos	
F	71-85	LESABRE Todos	
F	71-78	RIVIERA Todos	
F	91-96	ROADMASTER Todos	
F	87-92	CADILLAC BROUGHAM Todos	
F	92-96	COMMERCIAL CHASSIS 4x2 Tracción trasera	
F	77-84	COMMERCIAL CHASSIS Todos	
F	77-84	DEVILLE Todos	
F	93-96	FLEETWOOD Todos	
F	77-86	FLEETWOOD 4x2 Tracción trasera	
F	81	CHEVROLET BEL AIR Todos	
F	75	BEL AIR Sedan	
F	65-74	BEL AIR Todos	
F	65-72	BISCAYNE Todos	
F	69-72	BROOKWOOD Todos	
F	70-81	CAMARO Todos	
F	66-96	CAPRICE Todos	
F	94-96	IMPALA Todos	
F	83-85	IMPALA Todos	
F	82	IMPALA Sedan	
F	65-81	IMPALA Todos	
F	69-72	KINGSWOOD Todos	
F	69-72	TOWNSMAN Todos	
F	65-74	FORD COUNTRY SEDAN Todos	
F	87-91	COUNTRY SQUIRE Todos	
F	65-74	COUNTRY SQUIRE Todos	
F	92-02	CROWN VICTORIA Todos Exc. Sistema de Autonivelación NIVOMAT	
F	65-72	CUSTOM Todos	
F	68-77	CUSTOM 500 Todos	
F	65-67	GALAXIE Todos	
F	68-74	GALAXIE 500 Todos	
F	84-94	GHIA	
F	01-02	GRAND MARQUIS Todos	
F	87-91	LTD / COUNTRY SEDAN / COUNTRY SQUIRE / CROWN VICTORIA Todos	
F	67-82	LTD / COUNTRY SEDAN / COUNTRY SQUIRE / CROWN VICTORIA Todos	
F	77-79	LTD II Todos	
F	72-79	RANCHERO Todos	
F	65-74	RANCH WAGON Todos	
F	67-79	THUNDERBIRD Todos	
F	72-76	TORINO Todos	
F	70-80	LINCOLN CONTINENTAL Todos	
F	68-71	MARK III Todos	
F	72-76	MARK IV Todos	
F	77-79	MARK V Todos	
F	80-83	MARK VI Todos	

Lista numérica

Amort.	POP	No. Alternativo	Montaje Accesorio
Pos.	Año	Aplicación	
34073	W	-continued	141041
F	65-68	COMMUTER Todos	
F	74-79	COUGAR Todos	
F	92-02	GRAND MARQUIS Todos Exc. Sistema de Autonivelación NIVOMAT	
F	75-91	GRAND MARQUIS Todos	
F	69-70	MARAUDER Todos	
F	65-67	MARAUDER Todos	
F	67-82	MARQUIS Todos	
F	65-68	MONTCLAIR Todos	
F	72-76	MONTEGO Todos	
F	65-74	MONTEREY Todos	
F	65-68	PARKLANE Todos	
F	65-67	VILLAGER Todos	
F	66-67	VOYAGER Todos	
F	71-85	OLDSMOBILE 88 SERIES Todos	
F	71-84	98 Todos	
F	71-92	CUSTOM CRUISER Todos	
F	71-81	PONTIAC BONNEVILLE Todos	
F	71-81	CATALINA Todos	
F	70-81	FIREBIRD Todos	
F	71-78	GRAND SAFARI Todos	
F	76-81	LAURENTIAN Todos	
F	76-86	PARISIENNE Todos	
F	87-89	SAFARI Todos	
34076	X		140780
F	91-94	FORD EXPLORER Todos	
F	91-94	MAZDA NAVAJO Todos	
43048	C		
R	75-80	CHEVROLET LUV PICKUP Todos	
R	72-74	LUV PICKUP Todos	
F	55-56	TRUCK	
R	75-80	DODGE COLT Wagon	
R	71-74	COLT Todos	
R	79-82	D50 4x2 Tracción trasera	
R	87-93	PICKUP, RAM 50 4x2 Tracción trasera	
R	83-86	PICKUP, RAM 50 Todos	
F	48-52	FORD F SERIES	
R	55	F SERIES Todos F-100	
F	68-76	P-350	
F	75-76	P-400	
R	68	INTERNATIONAL 908C Todos	
R	68	1000C Todos	
R	68	1100C Todos Exc. Travelette c/ base de rueda de 166"	
R	68	1200C Todos Exc. Travelette c/ base de rueda de 166"	
R	68	1300C Todos Exc. Travelette c/ base de rueda de 166"	
R	68-72	M1100 / M1200 Todos	
R	69	M1400 Todos	
R	72-83	JEEP CJ5 Todos Exc. Kit de Levantamiento	
R	66-71	CJ5 Todos	
R	72-75	CJ6 Todos Exc. Kit de Levantamiento	
R	66-71	CJ6 Todos	
R	76-86	CJ7 Todos Exc. Kit de Levantamiento	
R	66-74	DJ5 Todos Exc. Kit de Levantamiento	
R	66-68	DJ6 Todos	
R	57-60	FC150 Todos	
R	63-65	FC170 Todos	
R	63-66	GLADIATOR Todos Suspensión Delantera Independiente	
R	70-73	JEEP STER Todos	
R	81-85	SCRAMBLER / CJ8 Todos	
R	67	UNIVERSAL Todos	
R	61-65	UNIVERSAL Todos	
R	86-87	MAZDA B2000 4x2 Tracción trasera	
R	87-93	B2200 4x2 Tracción trasera	
R	87-93	B2600 4x2 Tracción trasera	
R	95-96	MITSUBISHI MIGHTY MAX Todos	
R	83-94	MIGHTY MAX 4x2 Tracción trasera	
R	87-90	VAN Todos	
R	98-04	NISSAN FRONTIER 4x2 Tracción trasera Exc. Desert Runner	
R	87-94	PICKUP 4x2 Tracción trasera	
R	86	PICKUP 4x2 Tracción trasera Fabricado desde 8/86	
R	79-82	PLYMOUTH ARROW PICKUP Todos	
R	76-80	COLT Todos	
R	84-95	TOYOTA PICKUP 4x2 Tracción trasera	
R	75-83	PICKUP 4x2 Tracción trasera Mojave	
R	73-74	PICKUP Todos 4x2 Tracción trasera; Mojave	
R	70-72	PICKUP Todos 4x2 Tracción trasera	

Amortiguadores de Carga Traseros

Amort.	POP	No. Alternativo	Montaje Accesorio
Pos.	Año	Aplicación	
43048	C	-continued	
R	84-88	VAN Leaf (RearSpringType)	
R	88	VAN WAGON Todos	
43049	W		140630
R	71-73	BUICK CENTURION Todos	
R	92-96	COMMERCIAL CHASSIS Todos	
R	71-84	ELECTRA Todos	
R	71-85	LESABRE Todos	
R	71-78	RIVIERA Todos	
R	92-96	ROADMASTER Sedan	
R	64-67	SKYLARK Todos Exc. Suspensión HD	
R	64-67	SPECIAL Todos Exc. Suspensión HD	
R	87-92	CADILLAC BROUGHAM Todos	
R	92-96	COMMERCIAL CHASSIS 4x2 Tracción trasera	
R	77-84	COMMERCIAL CHASSIS Todos	
R	77-84	DEVILLE Todos	
R	93-96	FLEETWOOD 4x2 Tracción trasera	
R	77-86	FLEETWOOD 4x2 Tracción trasera	
R	81	CHEVROLET BEL AIR Todos	
R	75	BEL AIR Sedan	
R	65-74	BEL AIR Todos	
R	65-72	BISCAYNE Todos	
R	69-70	BROOKWOOD Todos	
R	81-96	CAPRICE Sedan Modelos Policía y Taxi	
R	76-80	CAPRICE Sedan Exc. Wagon	
R	75-80	CAPRICE Coupe Exc. Wagon	
R	75	CAPRICE Convertible Exc. Wagon	
R	75	CAPRICE Sedan	
R	73-74	CAPRICE Sedan Modelos Policía y Taxi	
R	71-72	CAPRICE Todos Modelos Policía y Taxi	
R	66-70	CAPRICE Todos	
R	64-67	CHEVELLE Todos Exc. Suspensión HD	
R	68	CHEVY II Todos Resorte Trasero de Hojas Múltiples	
R	64-67	EL CAMINO Todos	
R	94-96	IMPALA Todos	
R	83-85	IMPALA Todos	
R	65-82	IMPALA Sedan	
R	74-81	IMPALA Coupe	
R	73	IMPALA Hardtop	
R	69-70	KINGSWOOD Todos	
R	64-67	MALIBU Todos Exc. Suspensión HD	
R	69-72	NOVA Todos Resorte Trasero de Hojas Múltiples	
R	69-70	TOWNSMAN Todos	
R	65-85	OLDSMOBILE 88 SERIES Todos	
R	71-84	98 Todos	
R	64-67	CUTLASS / CUTLASS SUPREME Todos Exc. Suspensión HD	
R	64-67	F85 Todos Exc. Suspensión HD	
R	65-66	STARFIRE Todos	
R	63-81	PONTIAC BONNEVILLE Todos	
R	75-81	CATALINA Coupe	
R	71-81	CATALINA Sedan	
R	71-74	CATALINA Hardtop	
R	63-70	CATALINA Todos	
R	67-70	EXECUTIVE Todos	
R	64-67	GTO Todos Exc. Suspensión HD	
R	76-81	LAURENTIAN Todos	
R	64-67	LEMANS Todos Exc. Suspensión HD	
R	76-86	PARISIENNE Sedan	
R	64-67	TEMPEST Todos Exc. Suspensión HD	
R	71-72	VENTURA Leaf (RearSpringType)	
43058	W		140739
R	78-79	FORD BRONCO Todos Exc. Kit de Levantamiento	
R	66-77	BRONCO Todos Desde Serie #830001; Exc. Kit de Levantamiento	
R	75-79	PICKUP 1 TON, F-350 / SUPERDUTY Standard Cab Pickup, 4x2 Tracción trasera	
R	75-79	PICKUP 3/4 TON, F-250 / SUPERDUTY Cab & Chassis, 4x2 Tracción trasera	
R	75-79	PICKUP 3/4 TON, F-250 / SUPERDUTY Extended Cab Pickup, 4x2 Tracción trasera	
R	69-74	VAN 1/2 TON, ECONOLINE / CLUB WAGON Todos	
R	69-74	VAN 1 TON, ECONOLINE / CLUB WAGON / SUPERDUTY Todos	
R	69-74	VAN 3/4 TON, ECONOLINE / CLUB WAGON / SUPERDUTY Todos	
R	74-83	JEEP CHEROKEE Todos	

Lista numérica

Amort.	POP	No. Alternativo	Montaje Accesorio
Pos.	Año	Aplicación	
43058	W	-continued	140739
R	67	GLADIATOR Todos	
R	84-91	GRAND WAGONEER Todos	
R	74-88	J10 PICKUP Todos	
R	74-88	J20 PICKUP Todos	
R	68-73	J2500 PICKUP Todos	
R	74-83	WAGONEER Todos	
43060	W		140630
R	73-81	BUICK CENTURY Todos	
R	71-83	ESTATE WAGON Todos	
R	65-67	GRAN SPORT Todos	
R	68-72	GS / GS350 / GS400 / GS455 Todos	
R	73-87	REGAL Todos	
R	91-96	ROADMASTER Wagon	
R	68-72	SKYLARK Todos	
R	64-67	SKYLARK Todos Suspensión HD Exc. Sportwagon	
R	68-69	SPECIAL Todos	
R	64-67	SPECIAL Todos Suspensión HD Exc. Sportwagon	
R	70-72	SPORTWAGON Todos	
R	77-96	CHEVROLET CAPRICE Wagon	
R	68-73	CHEVELLE Todos	
R	64-67	CHEVELLE Todos Suspensión HD	
R	68-87	EL CAMINO Todos	
R	71-82	IMPALA Wagon	
R	73-83	MALIBU Todos	
R	64-67	MALIBU Todos Suspensión HD	
R	70-88	MONTE CARLO Todos	
R	78-87	GMC SPRINT / CABALLERO 4x2 Tracción trasera	
R	71-77	SPRINT / CABALLERO Todos	
R	74-77	NISSAN 710 Wagon	
R	78-80	810 Wagon	
R	77-92	OLDSMOBILE CUSTOM CRUISER Todos	
R	68-87	CUTLASS / CUTLASS SUPREME Todos	
R	64-67	CUTLASS / CUTLASS SUPREME Todos Suspensión HD	
R	80-83	CUTLASS CLASSIC / CUTLASS CRUISER Todos	
R	68-72	F85 Todos	
R	64-67	F85 Todos Suspensión HD	
R	71-78	TORONADO Todos	
R	82-86	PONTIAC BONNEVILLE Todos	
R	78-80	GRAND AM Todos	
R	73-75	GRAND AM Todos	
R	75-83	GRAND LEMANS Todos	
R	69-87	GRAND PRIX Todos	
R	71-78	GRAND SAFARI Todos	
R	71-75	GRANDVILLE Todos	
R	68-73	GTO Todos	
R	64-67	GTO Todos Suspensión HD	
R	68-81	LEMANS Todos	
R	64-67	LEMANS Todos Suspensión HD	
R	80-86	PARISIENNE Wagon	
R	76-79	PARISIENNE Todos Wagon	
R	87-89	SAFARI Todos	
R	68-70	TEMPEST Todos	
R	64-67	TEMPEST Todos Suspensión HD	
43062	W		
R	69-72	CHEVROLET BLAZER Todos 4x2 Tracción trasera; Resorte Trasero	
R	67-72	PICKUP 1/2 TON, C10 Todos Resorte Trasero	
R	67-72	PICKUP 3/4 TON, C20 Todos Resorte Trasero	
R	67-72	SUBURBAN 1/2 TON, C10 Todos	
R	68-72	SUBURBAN 3/4 TON, C20 Todos	
R	67-72	VAN 1/2 TON, P SERIES Todos	
R	70-72	GMC JIMMY Todos 4x2 Tracción trasera; Resorte Trasero	
R	67-72	PICKUP 1/2 TON, C15 / C1500 Todos	
R	67-72	PICKUP 3/4 TON, C25 / C2500 Todos	
R	68-72	SUBURBAN 1/2 TON, C15 / C1500 Todos	
R	68-72	SUBURBAN 3/4 TON, C25 / C2500 Todos	
R	68-72	VAN 1/2 TON, P SERIES Todos	
43067	W		
R	70-71	CHRYSLER 300 Todos	
R	67-73	IMPERIAL Todos	
R	70-73	NEWPORT Todos	
R	70-73	NEW YORKER Todos	
R	71-73	TOWN & COUNTRY Todos	
R	71	DODGE MONACO Todos	
R	72-93	PICKUP 1/2 TON, D100 SERIES Todos	

Lista numérica

Amort.	POP	No. Alternativo	Montaje Accesorio
Pos.	Año	Aplicación	
43067	W	-continued	
R	72-93	PICKUP 1 TON, D300 SERIES	Todos
R	72-93	PICKUP 3/4 TON, D200 SERIES	Todos
R	73	POLARA Wagon	
R	71	POLARA Todos	
R	76-93	RAMCHARGER 4x2 Tracción trasera	
R	74-75	RAMCHARGER Todos	
R	73	PLYMOUTH GRAN FURY Hardtop	
R	74-81	TRAILDUSTER Todos	
43084	W	140523	
R	70-81	CHEVROLET CAMARO Todos	
R	70-81	PONTIAC FIREBIRD Todos	
43085	W	140724	
R	84-86	DODGE MINI RAM Todos	
R	99-03	VAN 1/2 TON, A / B SERIES / RAM 109.3 (WheelBase) Exc. PBV 7000#	
R	81-98	VAN 1/2 TON, A / B SERIES / RAM 109.6 (WheelBase) Exc. PBV 7000#	
R	71-80	VAN 1/2 TON, A / B SERIES / RAM Todos	
R	99-03	VAN 1 TON, A / B SERIES / RAM Todos	
R	95-98	VAN 1 TON, A / B SERIES / RAM Todos Exc. Eje Delantero 4000#	
R	71-94	VAN 1 TON, A / B SERIES / RAM Todos	
R	71-03	VAN 3/4 TON, A / B SERIES / RAM Todos	
R	74-80	VAN, CB300 Todos	
R	74-83	PLYMOUTH VAN 1/2 TON, PB SERIES Todos	
R	74-83	VAN 1 TON, PB SERIES Todos	
R	74-83	VAN 3/4 TON, PB SERIES Todos	
43093	W	141058	
R	69-72	CHEVROLET BLAZER Todos 4x2 Tracción trasera; Resorte Trasero de Hojas Múltiples	
R	63-72	PICKUP 1/2 TON, C10 Todos Resorte Trasero de Hojas Múltiples	
R	67-72	PICKUP 1 TON, C30 Todos Exc. Eje Trasero 11,000#	
R	67-72	PICKUP 3/4 TON, C20 Todos Resorte Trasero de Hojas Múltiples	
R	63-66	PICKUP 3/4 TON, C20 Todos	
R	63-66	SUBURBAN 1/2 TON, 1500 Todos	
R	67-77	VAN 1/2 TON, G / EXPRESS Todos	
R	63-66	VAN 1/2 TON, P SERIES Todos	
R	76-77	VAN 1 TON, G / EXPRESS Todos	
R	75	VAN 1 TON, G / EXPRESS 110.0 (WheelBase)	
R	75	VAN 1 TON, G / EXPRESS 125.0 (WheelBase)	
R	71-74	VAN 1 TON, G / EXPRESS Todos	
R	68-72	VAN 1 TON, P SERIES Todos Exc. Eje Trasero 11,000#	
R	67-77	VAN 3/4 TON, G / EXPRESS Todos	
R	68-72	VAN 3/4 TON, P SERIES Todos	
R	67-72	GMC C15/C1500 PICKUP	
R	66-72	C25/C2500 PICKUP	
R	70-72	JIMMY 4x2 Tracción trasera	
R	67-72	PICKUP 1 TON, C35/3500 Todos Exc. Eje Trasero 11,000#	
R	63-65	PICKUP 1000 SERIES Todos	
R	63-65	PICKUP 1500 SERIES Todos	
R	67-77	VAN 1/2 TON, G / SAVANNA Todos	
R	67	VAN 1/2 TON, P SERIES Todos	
R	76-77	VAN 1 TON, G / SAVANNA Todos	
R	75	VAN 1 TON, G / SAVANNA 110.0 (WheelBase)	
R	75	VAN 1 TON, G / SAVANNA 125.0 (WheelBase)	
R	71-74	VAN 1 TON, G / SAVANNA Todos Exc. Base de rueda de 146"	
R	68-72	VAN 1 TON, P SERIES Todos Exc. Eje Trasero 11,000#	
R	67-77	VAN 3/4 TON, G / SAVANNA Todos	
R	68-72	VAN 3/4 TON, P SERIES Todos	
R	63-65	VAN, PB 1000 SERIES Todos	
43096	W		
R	65-69	CHRYSLER 300 Todos	
R	75-76	CORDOBA Todos	
R	74-75	IMPERIAL Todos	
R	74-78	NEWPORT Todos	
R	65-69	NEWPORT Todos	
R	74-78	NEW YORKER Todos	
R	65-69	NEW YORKER Todos	
R	74-78	TOWN & COUNTRY Todos	
R	65-70	TOWN & COUNTRY Todos	
R	65	DODGE 880 Todos	

Amortiguadores de Carga Traseros

Amort.	POP	No. Alternativo	Montaje Accesorio
Pos.	Año	Aplicación	
43096	W	-continued	
R	70-74	CHALLENGER Todos	
R	66-76	CHARGER Todos	
R	65-76	CORONET Todos	
R	77-78	MONACO Todos Paquete Policía	
R	72-76	MONACO Todos	
R	65-70	MONACO Todos	
R	73	POLARA Todos Exc. Wagon	
R	72	POLARA Todos	
R	62-70	POLARA Todos	
R	75-77	ROYAL MONACO Todos	
R	62-70	PLYMOUTH BELVEDERE Todos	
R	77-78	FURY Todos Paquete Policía	
R	74-76	FURY Todos	
R	73	FURY Wagon	
R	65-69	FURY Todos	
R	74-77	GRAN FURY Todos	
R	73	GRAN FURY Wagon	
R	67	GTX Todos	
R	73-75	ROADRUNNER Todos	
R	68-70	ROADRUNNER Todos	
R	73-74	SATELLITE Todos	
R	65-70	SATELLITE Todos	
R	70	SUPERBIRD Todos	
R	67	VIP Todos	
43099	W	140126	
R	66	FORD BRONCO Todos Toda la serie #830000	
R	75-79	PICKUP 1/2 TON, F-100 4x2 Tracción trasera	
R	75-79	PICKUP 1/2 TON, F-150 Standard Cab Pickup, 4x2 Tracción trasera	
R	75-79	PICKUP 1 TON, F-350 / SUPERDUTY Cab & Chassis, 4x2 Tracción trasera	
R	75-79	PICKUP 1 TON, F-350 / SUPERDUTY Extended Cab Pickup, 4x2 Tracción trasera	
R	75-79	PICKUP 3/4 TON, F-250 / SUPERDUTY Standard Cab Pickup, 4x2 Tracción trasera	
R	75-91	VAN 1/2 TON, ECONOLINE / CLUB WAGON Todos	
F	71-80	INTERNATIONAL SCOUT II Todos	
43107	W		
F	87-91	CHEVROLET BLAZER 4x4 Automóvil Grande; Exc. Suspensión Quad y Kit de Levantamiento	
F	75-86	BLAZER 4x4 Exc. Suspensión Quad y Kit de Levantamiento	
F	73-74	BLAZER 4x4 Exc. Kit de Levantamiento	
F	69-72	BLAZER 4x4	
F	81-86	PICKUP 1/2 TON, K10 Todos Suspensión Estándar; Exc. Kit de Levantamiento	
F	69-80	PICKUP 1/2 TON, K10 Todos Exc. Kit de Levantamiento	
F	87	PICKUP 1/2 TON, V10 Todos Exc. Suspensión Quad y Kit de Levantamiento	
F	81-86	PICKUP 3/4 TON, K20 Todos Suspensión Estándar; Exc. Kit de Levantamiento	
F	75-80	PICKUP 3/4 TON, K20 Todos Exc. Kit de Levantamiento	
F	73-74	PICKUP 3/4 TON, K20 Todos Exc. Suspensión Quad y Kit de Levantamiento	
F	87	PICKUP 3/4 TON, V20 Todos Exc. Suspensión Quad y Kit de Levantamiento	
F	81-86	SUBURBAN 1/2 TON, K10 Todos Suspensión Estándar; Exc. Kit de Levantamiento	
F	69-80	SUBURBAN 1/2 TON, K10 Todos Exc. Kit de Levantamiento	
F	87-88	SUBURBAN 1/2 TON, R10 Todos Exc. Suspensión Quad y Kit de Levantamiento	
F	70-91	GMC JIMMY 4x4 Exc. Suspensión Quad y Kit de Levantamiento	
F	73-86	PICKUP 1/2 TON, K15 / K1500 Todos Exc. Suspensión Quad y Kit de Levantamiento	
F	69-72	PICKUP 1/2 TON, K15 / K1500 Todos	
F	87	PICKUP 1/2 TON, V1500 Todos Exc. Kit de Levantamiento	
F	69-86	PICKUP 3/4 TON, K25 / K2500 Todos Exc. Suspensión Quad y Kit de Levantamiento	

Lista numérica

Amort.	POP	No. Alternativo	Montaje Accesorio
Pos.	Año	Aplicación	
43107	W	-continued	
F	87	PICKUP 3/4 TON, V2500 Todos	Exc. Kit de Levantamiento
F	69-86	SUBURBAN 1/2 TON, K15 / K1500 Todos Exc. Suspensión Quad y Kit de Levantamiento	
F	87-91	SUBURBAN 1/2 TON, V1500 Todos	Exc. Kit de Levantamiento
F	69-86	SUBURBAN 3/4 TON, K25 / K2500 Todos Exc. Suspensión Quad y Kit de Levantamiento	
F	87-91	SUBURBAN 3/4 TON, V2500 Todos	Exc. Kit de Levantamiento
43111	D	140702	
R	87-91	CHEVROLET BLAZER Todos Automóvil Grande; Exc. Suspensión Quad y Kit de Levantamiento	
R	73-86	BLAZER Todos Exc. Kit de Levantamiento	
R	73-86	PICKUP 1/2 TON, C10 Todos	
R	73-86	PICKUP 1/2 TON, K10 Todos Exc. Suspensión Quad y Kit de Levantamiento	
R	87	PICKUP 1/2 TON, R10 Todos	
R	87	PICKUP 1/2 TON, V10 Todos Exc. Suspensión Quad y Kit de Levantamiento	
R	75-86	PICKUP 3/4 TON, C20 Standard Cab Pickup	
R	73-74	PICKUP 3/4 TON, C20 Todos Standard Cab Pickup	
R	73-86	PICKUP 3/4 TON, K20 Todos Exc. Suspensión Quad y Kit de Levantamiento	
R	87	PICKUP 3/4 TON, R20 Standard Cab Pickup	
R	87	PICKUP 3/4 TON, V20 Todos Exc. Suspensión Quad y Kit de Levantamiento	
R	73-86	SUBURBAN 1/2 TON, C10 Todos	
R	73-86	SUBURBAN 1/2 TON, K10 Todos Exc. Suspensión Quad y Kit de Levantamiento	
R	87-88	SUBURBAN 1/2 TON, R10 Todos	
R	89-91	SUBURBAN 1/2 TON, R1500 Todos	
R	89-91	SUBURBAN 1/2 TON, V1500 Todos	Exc. Suspensión Quad y Kit de Levantamiento
R	73-86	SUBURBAN 3/4 TON, C20 Todos	
R	73-86	SUBURBAN 3/4 TON, K20 Todos Exc. Suspensión Quad y Kit de Levantamiento	
R	87-88	SUBURBAN 3/4 TON, R20 Todos	
R	89-91	SUBURBAN 3/4 TON, R2500 Todos	
R	87-88	SUBURBAN 3/4 TON, V20 Todos	Exc. Suspensión Quad y Kit de Levantamiento
R	89-91	SUBURBAN 3/4 TON, V2500 Todos	Exc. Suspensión Quad y Kit de Levantamiento
R	73	VAN 1/2 TON, P SERIES Todos	
R	73-78	VAN 3/4 TON, P SERIES Todos	
R	73-91	GMC JIMMY Todos Exc. Kit de Levantamiento	
R	73-86	PICKUP 1/2 TON, C15 / C1500 Todos	
R	75-86	PICKUP 1/2 TON, K15 / K1500 Todos Exc. Suspensión Quad y Kit de Levantamiento	
R	87	PICKUP 1/2 TON, R1500 Todos	
R	87	PICKUP 1/2 TON, V1500 Todos	Suspensión Quad Exc. Kit de Levantamiento
R	75-86	PICKUP 3/4 TON, C25 / C2500 Cab & Chassis	
R	75-86	PICKUP 3/4 TON, C25 / C2500 Standard Cab Pickup	
R	73-74	PICKUP 3/4 TON, C25 / C2500 Todos	
R	86	PICKUP 3/4 TON, K25 / K2500 Todos Exc. Kit de Levantamiento	
R	73-85	PICKUP 3/4 TON, K25 / K2500 Todos Exc. Suspensión Quad y Kit de Levantamiento	
R	88-89	PICKUP 3/4 TON, R2500 Todos	Exc. Crew Cab y Bonus Cab
R	87	PICKUP 3/4 TON, R2500 Cab & Chassis	Exc. Crew Cab y Bonus Cab
R	87	PICKUP 3/4 TON, R2500 Standard Cab Pickup	Exc. Crew Cab y Bonus Cab
R	87	PICKUP 3/4 TON, V2500 Todos	Exc. Kit de Levantamiento

Lista numérica

Amort.	POP	No. Alternativo	Montaje Accesorio
Pos.	Año	Aplicación	
43111	D	-continued	140702
R	73-86	SUBURBAN 1/2 TON, C15 / C1500 Todos	
R	85-86	SUBURBAN 1/2 TON, K15 / K1500 Todos Exc. Suspensión Quad y Kit de Levantamiento	
R	84	SUBURBAN 1/2 TON, K15 / K1500 Todos Exc. Kit de Levantamiento	
R	73-83	SUBURBAN 1/2 TON, K15 / K1500 Todos Exc. Suspensión Quad y Kit de Levantamiento	
R	87-91	SUBURBAN 1/2 TON, R1500 Todos	
R	87-91	SUBURBAN 1/2 TON, V1500 Todos Exc. Kit de Levantamiento	
R	73-86	SUBURBAN 3/4 TON, C25 / C2500 Todos	
R	73-86	SUBURBAN 3/4 TON, K25 / K2500 Todos Exc. Suspensión Quad y Kit de Levantamiento	
R	87-91	SUBURBAN 3/4 TON, R2500 Todos	
R	87-91	SUBURBAN 3/4 TON, V2500 Todos Exc. Kit de Levantamiento	
R	73	VAN 1/2 TON, P SERIES Todos	
R	73-78	VAN 3/4 TON, P SERIES Todos	
43138	X		140873
R	77-83	CHRYSLER CORDOBA Todos	
R	83-89	FIFTH AVENUE Todos	
R	81-83	IMPERIAL Todos	
R	77-81	LEBARON Todos	
R	79-81	NEWPORT Todos	
R	79-82	NEW YORKER Todos	
R	79-81	TOWN & COUNTRY Todos	
R	76-80	DODGE ASPEN Todos	
R	77-78	CHARGER Todos	
R	77-89	DIPLOMAT Todos	
R	78-79	MAGNUM Todos	
R	80-83	MIRADA Todos	
R	77-78	MONACO Todos Exc. Paquete Policía	
R	79-81	ST. REGIS Todos	
R	77-78	PLYMOUTH FURY Todos Exc. Paquete Policía	
R	80-89	GRAN FURY Todos	
R	76-80	VOLARE Todos	
43140	W		141150
R	65-74	FORD COUNTRY SEDAN Todos	
R	87-91	COUNTRY SQUIRE Todos	
R	65-74	COUNTRY SQUIRE Todos	
R	92-02	CROWN VICTORIA Todos	
R	65-72	CUSTOM Todos	
R	68-77	CUSTOM 500 Todos	
R	65-67	GALAXIE Todos	
R	68-74	GALAXIE 500 Todos	
R	01-02	GRAND MARQUIS Todos	
R	87-91	LTD / COUNTRY SEDAN / COUNTRY SQUIRE / CROWN VICTORIA Todos	
R	67-82	LTD / COUNTRY SEDAN / COUNTRY SQUIRE / CROWN VICTORIA Todos	
R	77-79	LTD II Todos	
R	72-79	RANCHERO Todos	
R	65-74	RANCH WAGON Todos	
R	77-79	THUNDERBIRD Todos	
R	67-72	THUNDERBIRD Todos	
R	72-76	TORINO Todos	
R	70-80	LINCOLN CONTINENTAL Todos	
R	68-71	MARK III Todos	
R	72	MARK IV Todos	
R	80-83	MARK VI Todos	
R	81-02	TOWN CAR Todos	
R	67	MERCURY BROUGHAM Todos	
R	87-91	COLONY PARK Todos	
R	65-74	COLONY PARK Todos	
R	65-68	COMMUTER Todos	
R	74-79	COUGAR Todos	
R	92-02	GRAND MARQUIS Todos Exc. Sistema de Autonivelación NIVOMAT	
R	75-91	GRAND MARQUIS Todos	
R	69-70	MARAUDER Todos	
R	65-67	MARAUDER Todos	
R	67-82	MARQUIS Todos	
R	65-68	MONTCLAIR Todos	
R	72-76	MONTEGO Todos	
R	65-74	MONTEREY Todos	
R	65-68	PARKLANE Todos	
R	65-67	VILLAGER Todos	
R	66-67	VOYAGER Todos	
43142	W		
R	80-96	FORD BRONCO Todos Exc. Kit de Levantamiento	

Amortiguadores de Carga Traseros

Amort.	POP	No. Alternativo	Montaje Accesorio
Pos.	Año	Aplicación	
43142	W	-continued	
R	80-83	PICKUP 1/2 TON, F-100 4x2 Tracción trasera	
R	80-84	PICKUP 1/2 TON, F-150 4x2 Tracción trasera	
43143	W		141282
R	78-83	FORD FAIRMONT Todos	
R	81-82	GRANADA Todos	
R	83-86	LTD / COUNTRY SEDAN / COUNTRY SQUIRE / CROWN VICTORIA Todos	
R	87-93	MUSTANG / MUSTANG II LX, 2.3L 4Cyl L (140)	
R	84-86	MUSTANG / MUSTANG II LX	
R	82-84	MUSTANG / MUSTANG II L	
R	82-83	MUSTANG / MUSTANG II GL	
R	82-83	MUSTANG / MUSTANG II GLX	
R	82	MUSTANG / MUSTANG II Ghia	
R	79-81	MUSTANG / MUSTANG II Todos	
R	79-86	MERCURY CAPRI Todos	
R	81-82	COUGAR Base	
R	82	COUGAR GS	
R	82	COUGAR LS	
R	83-86	MARQUIS Todos	
R	78-83	ZEPHYR Todos	
43161	W		
R	90-05	CHEVROLET ASTRO Todos	
R	85-89	ASTRO 4x2 Tracción trasera	
R	90-05	GMC SAFARI Todos	
R	85-89	SAFARI 4x2 Tracción trasera	
43162	W		
R	05	CHEVROLET BLAZER Base, 4x4	
R	05	BLAZER Base, 4x2 Tracción trasera	
R	96-04	BLAZER LS, 4x4	
R	96-04	BLAZER LS, 4x2 Tracción trasera	
R	95-02	BLAZER LT, 4x2 Tracción trasera	
R	95-01	BLAZER LT, 4x4	
R	95-99	BLAZER Base, 4x4	
R	95-99	BLAZER Base, 4x2 Tracción trasera	
R	95-97	BLAZER Deluxe, 4x2 Tracción trasera	
R	83-94	BLAZER, S MODELS Todos	
R	99-04	S10 LS, 4x4	
R	99-03	S10 Base, 4x4	
R	99-03	S10 Base, 4x2 Tracción trasera	
R	99-03	S10 LS, 4x2 Tracción trasera	
R	94-98	S10 LS	
R	82-98	S10 Base	
R	92-93	S10 EL	
R	83-92	S10 Tahoe	
R	88-90	S10 Durango	
R	82-86	S10 Durango	
R	05	GMC JIMMY 4x4	
R	92-04	JIMMY Todos	
R	83-91	S15 JIMMY Todos	
R	82-04	SONOMA / S15 Todos	
R	91	SYCLONE AWD	
R	92-93	TYPHOON Todos	
R	98-00	ISUZU HOMBRE Todos	
R	96-97	HOMBRE 4x2 Tracción trasera	
R	96-01	OLDSMOBILE BRAVADA Todos	
R	91-94	BRAVADA Todos	
43163	D		
R	88-99	CHEVROLET PICKUP 1/2 TON, C15 / C1500 Todos	
R	88-99	PICKUP 1/2 TON, K15 / K1500 Todos	
R	01-03	PICKUP 1 TON, C35/3500 HD Eje Delantero Rígido HD	
R	91-00	PICKUP 1 TON, C35/3500 Todos Eje Delantero Rígido HD	
R	88-90	PICKUP 1 TON, C35/3500 Extended Cab Pickup Eje Delantero Rígido HD	
R	88-90	PICKUP 1 TON, C35/3500 Standard Cab Pickup Eje Delantero Rígido HD	
R	88-00	PICKUP 1 TON, K35 / K3500 Todos	
R	88-00	PICKUP 3/4 TON, C25 / C2500 Todos	
R	88-00	PICKUP 3/4 TON, K25 / K2500 Todos	
R	01-02	GMC C3500	
R	88-99	PICKUP 1/2 TON, C15 / C1500 Todos	
R	88-99	PICKUP 1/2 TON, K15 / K1500 Todos	
R	91-00	PICKUP 1 TON, C35/3500 Todos Eje Delantero Rígido HD	
R	88-90	PICKUP 1 TON, C35/3500 Extended Cab Pickup Eje Delantero Rígido HD	
R	88-90	PICKUP 1 TON, C35/3500 Standard Cab Pickup Eje Delantero Rígido HD	
R	88-00	PICKUP 1 TON, K35 / K3500 Todos	

Lista numérica

Amort.	POP	No. Alternativo	Montaje Accesorio
Pos.	Año	Aplicación	
43163	D	-continued	
R	88-00	PICKUP 3/4 TON, C25 / C2500 Todos	
R	88-00	PICKUP 3/4 TON, K25 / K2500 Todos	
43165	W		
R	89	FORD BRONCO II Todos Fab. hasta 2/89; Vehículos con perno 10mm y 12mm en montaje inferior trasero	
R	84-88	BRONCO II Todos Con Perno de 10mm en Montaje Inferior Trasero	
R	89	RANGER 4x2 Tracción trasera Fab. hasta 2/89; Vehículos con perno 10mm y 12mm en montaje inferior trasero	
R	83-88	RANGER 4x2 Tracción trasera	
43167	D		
R	85-96	FORD PICKUP 1/2 TON, F-150 4x2 Tracción trasera	
R	80-97	PICKUP 1 TON, F-350 / SUPERDUTY 4x2 Tracción trasera Exc. Doble Rodada Trasera	
R	97	PICKUP 3/4 TON, F-250 / SUPERDUTY 4x2 Tracción trasera PBV arriba de 8500#	
R	80-96	PICKUP 3/4 TON, F-250 / SUPERDUTY 4x2 Tracción trasera	
R	12	RANGER Todos Coil (FrontSpringType)	
R	06-11	RANGER 4x4, Coil (FrontSpringType)	
R	90-05	RANGER 4x2 Tracción trasera	
43171	W		140719
R	95-01	FORD EXPLORER Todos Exc. Suspensión Electrónica Ajustable	
R	01-05	EXPLORER SPORT TRAC Todos	
R	97-01	MERCURY MOUNTAINEER Todos Exc. Suspensión Electrónica Ajustable	
43172	X		140719
R	91-94	FORD EXPLORER Todos	
R	91-94	MAZDA NAVAJA Todos	
43173	W		
R	95-03	FORD WINDSTAR Coil (RearSpringType)	
43180	W		
R	99-00	CADILLAC ESCALADE Todos	
R	92-94	CHEVROLET BLAZER 4x4 Automóvil Grande	
R	92-99	SUBURBAN 1/2 TON, C15 / C1500 Todos	
R	92-99	SUBURBAN 1/2 TON, K15 / K1500 Todos	
R	92-99	SUBURBAN 3/4 TON, C25 / C2500 Todos	
R	92-99	SUBURBAN 3/4 TON, K25 / K2500 Todos	
R	95-00	TAHOE Todos Old Body Style	
R	96-11	VAN 1/2 TON, G / EXPRESS Todos	
R	96-02	VAN 1 TON, G / EXPRESS Todos	
R	96-02	VAN 3/4 TON, G / EXPRESS Todos Exc. PBV 8600 #	
R	92-99	GMC SUBURBAN 1/2 TON, C15 / C1500 Todos	
R	92-99	SUBURBAN 1/2 TON, K15 / K1500 Todos	
R	92-99	SUBURBAN 3/4 TON, C25 / C2500 Todos	
R	92-99	SUBURBAN 3/4 TON, K25 / K2500 Todos	
R	96-11	VAN 1/2 TON, G / SAVANNA Todos	
R	96-02	VAN 1 TON, G / SAVANNA Todos	
R	96-02	VAN 3/4 TON, G / SAVANNA Todos Exc. PBV 8600 #	
R	92-99	YUKON Todos	
43181	D		
R	03-07	CHEVROLET CHEYENNE	
R	99-06	PICKUP 1/2 TON, SILVERADO 1500 4x2 Tracción trasera Exc. Suspensión Electrónica Ajustable	
R	07	SILVERADO 1500 CLASSIC 4x2 Tracción trasera Exc. Suspensión Electrónica Ajustable	
R	94-01	DODGE PICKUP 1/2 TON, RAM 1500 Todos	
R	94-02	PICKUP 1 TON, RAM 3500 4x2 Tracción trasera Exc. Eje Delantero Rígido	

Lista numérica

Amortiguadores de Carga Traseros, Amortiguadores Guardian
Hidráulicos, Cartuchos Hidráulicos, Cartuchos de Strut Ultra

Lista numérica

Amort.	POP	No. Alternativo	Montaje Accesorio
Pos.	Año	Aplicación	
43181	D	-continued	
R	94-02	PICKUP 3/4 TON, RAM 2500 4x2 Tracción trasera	
R	99-06	GMC SIERRA 1500 4x2 Tracción trasera Exc. Suspensión Electrónica Ajustable	
R	07	SIERRA 1500 CLASSIC 4x2 Tracción trasera Exc. Suspensión Electrónica Ajustable	
43182	FF		
R	00-06	CHEVROLET SUBURBAN 1/2 TON, 1500 Todos Exc. Suspensión Z55 Auto Ride	
R	00-06	TAHOE Todos Exc. Suspensión Z55 Auto Ride	
R	00-06	GMC YUKON Todos Exc. Suspensión Z55 Auto Ride	
R	00-06	YUKON XL	
43183	FF		
R	04-08	FORD LOBO PICK UP	
R	04-08	PICKUP 1/2 TON, F-150 4x2 Tracción trasera	
43184	FF		
R	04-08	FORD LOBO PICK UP	
R	04-08	PICKUP 1/2 TON, F-150 4x4	
R	12	RANGER Todos 4x4	
R	83-11	RANGER 4x4	
43185	FF		
R	12	FORD RANGER Todos 4x4	
R	83-11	RANGER 4x4	
R	94-08	MAZDA B3000 Todos	
R	94-08	B4000 Todos	
43186	FF		
R	00-03	CHRYSLER GRAND VOYAGER	
R	95-07	TOWN & COUNTRY	
R	00-03	VOYAGER	
R	95-07	DODGE CARVAN	
R	95-07	GRAND CARAVAN	
R	95-00	PLYMOUTH GRAND CARAVAN	
R	95-00	VOYAGER	
Amortiguadores Guardian Hidráulicos			
40025	C		
R	00-09	PEUGEOT 206	
R	11	207	
42094	A		
R	70-79	VOLKSWAGEN BEETLE	
R	74-83	BRASILIA	
R	73-80	SAFARI	
R	89-02	SEDAN	
R	52-87	SEDAN	
F	52-72	SEDAN	
42161	A		
F	70-75	VOLKSWAGEN BEETLE	
F	74-83	BRASILIA	
F	73-80	SAFARI	
F	89-02	SEDAN	
F	73-87	SEDAN	
42446	W		
F	81	CHEVROLET CAPRICE	
F	75-76	IMPALA	
F	65-72	IMPALA	
42459	D		
R	82-89	CHRYSLER DART K	
R	86-88	LEBARON	
R	86-89	MAGNUM K	
R	85-93	NEW YORKER	
R	87-94	PHANTOM	
R	88-94	SHADOW	
R	89-95	SPIRIT RT	
R	86-89	VOLARE	
R	82-89	DODGE DART K	
R	83-88	MAGNUM K	
R	88-94	SHADOW Todos	
R	91-92	SPIRIT R/T	
R	84-88	PLYMOUTH VOLARE K	
42494	FF		
F	68-73	CHEVROLET CHEVELLE	
42508	C		
R	84-87	NISSAN TSURU	
42514	FF		
R	76	CHEVROLET IMPALA	
R	65-72	IMPALA	

Amort.	POP	No. Alternativo	Montaje Accesorio
Pos.	Año	Aplicación	
42517	D		
R	82-96	BUICK CENTURY	
R	80-85	SKYLARK	
R	82-90	CHEVROLET CELEBRITY	
R	89-97	CENTURY	
R	85-86	CENTURY	
R	86-88	CITATION	
R	80-83	CITATION	
R	84-85	CITATION II	
R	86-97	CUTLASS	
R	91-96	EUROSPORT	
R	82-96	OLDSMOBILE CUTLASS CIERA	
R	87-94	CUTLASS CRUISER	
R	80-84	OMEGA	
R	82-91	PONTIAC 6000	
R	80-84	PHOENIX	
42520	A		
R	94-12	CHEVROLET CHEVY	
42530	W		
R	90-94	CHEVROLET CAVALIER	
42952	C		
F	65-85	FORD F-350 PICKUP	
F	86-97	PICKUP 1 TON, F-350 / SUPERDUTY 4x4	
R	72-01	VOLKSWAGEN COMBI	
R	52-77	COMBI CARAVEL	
R	72-01	COMBI PANEL	
42953	D		
F	72-01	VOLKSWAGEN COMBI	
F	52-77	COMBI CARAVEL	
F	72-01	COMBI PANEL	
42954	A		
R	07-12	DODGE ATOS	
42957	W		
F	70-72	DODGE D100 PICKUP	
R	70-72	D100 PICKUP	
F	67-68	D300	
F	67-68	D300	
F	80-83	RAMCHARGER	
F	89-90	W250	
F	85-87	W250	
42958	D		
R	87	CHEVROLET C10	
R	85-87	C20	
R	79-86	C30	
R	89-90	P30	
R	79-86	PICKUP 1/2 TON, C10 Todos	
R	89-91	PICKUP 1 TON, C35/3500 Todos	
R	84-86	FORD F-150	
R	88-90	GMC C1500	
R	80-85	C1500	
R	87-91	C2500	
R	80-87	C3500	
R	88-91	PICKUP 1 TON, C35/3500 Todos	
42959	W		
R	79	FORD F-150	
42960	D		
R	73-74	DODGE D100 PICKUP	
R	88-90	D150	
R	82	D150	
R	80	D150	
R	89-90	D250	
R	78-80	D300	
R	89-90	D350	
R	81-87	D350	
R	80-94	RAMCHARGER	
42961	D		
F	65-66	CHEVROLET C1405	
F	87	C10	
F	85-87	C20	
F	79-87	C30	
F	88-91	C2500	
F	89-91	C3500	
F	67	C3605	
F	65-67	C20905	
F	64-78	CS1073	
F	64-78	CS31003	
F	89-90	P30	
F	79-86	PICKUP 1/2 TON, C10 Todos	
F	88-90	GMC C1500	
F	80-86	C1500	
F	87-91	C2500	
F	81-91	C3500	
F	90	MICROBUS	
42962	D		
F	73-74	DODGE D100 PICKUP	

Amort.	POP	No. Alternativo	Montaje Accesorio
Pos.	Año	Aplicación	
42962	D	-continued	
F	88-90	D150	
F	82-83	D150	
F	80	D150	
F	89-90	D250	
F	94	RAMCHARGER	
F	80-90	RAMCHARGER	
42963	D		
F	78-79	DODGE D300	
F	80-90	D350	
F	88-93	MICROBUS	
F	84-94	RAMCHARGER	
42967	C		
F	82-85	FORD B150	
F	92	B200	
F	97	BRONCO	
F	84-97	F-150	
F	86-90	F-200	
F	86-97	P350 MICROBUS	
F	80-97	PICKUP 1 TON, F-350 / SUPERDUTY 4x2 Tracción trasera	
42968	D		
R	90-94	CHEVROLET S10 BLAZER	
42969	D		
F	90-94	CHEVROLET S10 BLAZER	
42970	B		
R	65-93	NISSAN PICKUP	
42971	W		
F	79-81	FORD B100	
F	73-74	B100	
F	75-78	B150	
42972	A		
F	65-08	NISSAN PICKUP	
42973	A		
F	68-75	JEEP CJ7	
F	80-83	J100	
R	80-83	J100	
F	76-86	WAGONEER	
R	84-08	NISSAN PICKUP	
Cartuchos Hidráulicos			
44763	B		
F	77-87	VOLKSWAGEN ATLANTIC	
F	77-87	CARIBE	
Cartuchos de Strut Ultra			
G44450	W	141429	
F	92-94	AUDI 100 Todos	
F	91	100 Todos Fabricado a finales del 91	
F	89-90	100 Todos	
F	89-94	100 QUATTRO Todos	
F	89-90	200 Todos	
F	89-90	200 QUATTRO Wagon	
F	78-88	5000 Todos	
F	95-97	A6 QUATTRO Todos	
F	92-94	S4 Todos	
F	95-97	S6 Todos	
F	90-94	V8 QUATTRO Todos	
G44451	W	141860	
F	84-86	BUICK SKYHAWK Todos Struts Reconstruibles de EO	
F	86-91	SKYLARK Todos Struts Reconstruibles de EO	
F	85-87	SOMERSET / SOMERSET REGAL Todos Struts Reconstruibles de EO	
F	84-86	CADILLAC CIMARRON Todos Struts Reconstruibles de EO	
F	84-86	CHEVROLET CAVALIER Todos Struts Reconstruibles de EO	
F	85-86	OLDSMOBILE CALAIS Todos Struts Reconstruibles de EO	
F	84-86	FIRENZA Todos Struts Reconstruibles de EO	
F	85-86	PONTIAC GRAND AM Todos Struts Reconstruibles de EO	
F	84-85	J2000 / SUNBIRD Todos Struts Reconstruibles de EO	
F	86-87	SUNBIRD Todos Struts Reconstruibles de EO	
G44459	C	141934	
F	88-96	BUICK REGAL Todos	
F	90-01	CHEVROLET LUMINA Todos	
F	97	LUMINA VAN	
F	95-99	MONTE CARLO Todos	
F	88-97	OLDSMOBILE CUTLASS / CUTLASS SUPREME Todos	

Lista numérica

Amort.	POP	No. Alternativo	Montaje Accesorio
Pos.	Año	Aplicación	
G44459	C	-continued	141934
F	88-96	PONTIAC GRAND PRIX Todos	
G44461	W		140804
F	94-98	SAAB 900 Turbocharged (Eng Asp)	
F	93	900 Turbocharged (Eng Asp) Fab. desde 6/30/93	
G44477	X		141039
R	92-94	TOYOTA CAMRY 4x2 Tracción delantera Struts Reconstruibles de EO	
G44493	W		
F	92-95	BMW 525i Todos Exc. Suspensión Electrónica Ajustable	
G44495	W		141741
F	94-98	SAAB 900 Naturally Aspirated (Eng Asp)	
F	93	900 Naturally Aspirated (Eng Asp) Fab. desde 6/30/93	
G44497	D		
F	92	BMW 525i Todos Fabricado antes de Sep/92	
F	91	525i Todos	
F	90	525i Todos Fab. desde 8/90	
F	94-95	530i Sedan	
F	91-93	535i Todos	
F	90	535i Todos Fab. desde 8/90	
F	94-95	540i Todos	
G44713	W		141422
F	77-83	BMW 320i Todos	
G44723	W		
F	80-82	TOYOTA TERCEL	
G44724	W		141028
F	81-84	TOYOTA STARLET Todos	
G44735	W		141028
F	81-85	MAZDA RX7 GS	
F	81-85	RX7 S	
G44743	D		142167
F	89-90	TOYOTA TERCEL Todos	
F	87-88	TERCEL Hatchback	
F	87-88	TERCEL Sedan	
G44745	W		141428
F	86	BMW 318	
F	91	318i Todos	
F	84-85	318i Todos	
F	91	318iS Todos	
G44747	D		141867
F	87	TOYOTA COROLLA 4x2 Tracción delantera Exc. Struts Delanteros Reconstruibles FX16	
F	86	COROLLA 4x2 Tracción delantera Struts Delanteros Reconstruibles	
F	84-85	COROLLA 4x2 Tracción delantera, GAS Struts Delanteros Reconstruibles	
G44748	D		142167
F	87	TOYOTA TERCEL Wagon, 4x2 Tracción delantera	
F	83-86	TERCEL 4x2 Tracción delantera	
G44752	D		141796
F	80-83	NISSAN 200SX Todos	
F	79-82	210 Todos	
F	78-81	510 Todos	
F	74-78	B210 Todos	
F	79-84	DATSUN	
F	79-84	NISSAN SEDAN	
F	82-85	SAKURA	
F	79-84	SAMURAI	
G44763	D		142730
F	77-87	VOLKSWAGEN ATLANTIC	
F	85-93	CABRIOLET Todos	
F	77-87	CARIBE	
F	80-84	JETTA Todos	
F	75-84	RABBIT Todos	
F	80-83	RABBIT PICKUP Todos	
F	75-89	SCIROCCO Todos	
G44766	D		141796
R	86	NISSAN MULTI Todos	
R	82-86	STANZA Todos	
G44767	W		141796
F	86-88	NISSAN MULTI Todos	

Cartuchos de Strut Ultra

Amort.	POP	No. Alternativo	Montaje Accesorio
Pos.	Año	Aplicación	
G44767	W	-continued	141796
F	82-86	STANZA Todos	
G44774	W		142717
F	90-92	VOLKSWAGEN CORRADO 1.8L 4Cyl L (1780) Struts Delanteros Reconstruibles	
F	87-91	GOLF	
F	87-91	GTI	
F	87-91	JETTA A2 (Código plataforma del fabricante) Reemplazo de cartucho de Equipo Original	
G44775	W		141662
F	87-88	BMW 325 Todos Exc. Suspensión Deportiva	
F	84-87	325E Todos Exc. Suspensión Deportiva	
F	87-92	325i E30 (Código plataforma del fabricante) Exc. Suspensión Deportiva	
F	87-92	325iS Todos Exc. Suspensión Deportiva	
G44776	D		141923
R	91-94	NISSAN AXCESS Todos	
R	90	AXCESS 4x2 Tracción delantera	
R	86-88	MAXIMA Sedan Exc. Suspensión Electrónica Ajustable	
R	85	MAXIMA Todos Exc. Suspensión Electrónica Ajustable	
R	87-88	MULTI Todos	
R	87-89	STANZA Sedan	
G44783	D		141039
F	95-96	TOYOTA AVALON Todos Struts Reconstruibles de EO	
F	95-96	CAMRY Todos Struts Reconstruibles de EO	
G44800	D		142167
F	83-88	TOYOTA TERCEL Wagon, 4x4	
G44802	W		141028
F	85-89	TOYOTA MR2 Todos	
G44803	D		141028
R	85-86	TOYOTA MR2 Todos	
G44850	W		141420
F	87-88	PORSCHE 924 Todos	
F	77-82	924 Todos	
F	83-88	944 Todos	
F	76-79	VOLKSWAGEN BEETLE Todos	
F	74-79	SUPER BEETLE Todos	
F	73	SUPER BEETLE Todos Montaje inferior de 2 pernos tipo brida	
G44856	W		142284
F	75-93	VOLVO 240 / 242 / 244 / 245 / 262 / 264 / 265 Todos	
F	84	DL Todos Exc. Sistema de Autonivelación NIVOMAT	
F	84	GLE Todos Exc. Sistema de Autonivelación NIVOMAT	
G44862	W		141748
F	71-73	VOLKSWAGEN SUPER BEETLE Todos Montaje inferior con 3 pernos tipo brida	
G44867	W		141800
R	74-75	NISSAN 260Z 2+2	
R	75-78	280Z Todos	
G44868	W		141760
R	70-73	NISSAN 240Z Todos	
R	74	260Z Base	
G44869	W		141762
F	70-73	NISSAN 240Z Todos	
F	74-75	260Z Todos	
F	75-78	280Z Todos	
F	79-83	280ZX Todos	
F	81	810 Todos	
F	82-84	MAXIMA Todos	
G44898	W		141039
F	79-82	TOYOTA CORONA Todos	
F	78-80	CRESSIDA Todos	
G44902	A		142717
F	88-92	AUDI 80 Todos	
F	88-92	80 QUATTRO Todos	
F	96-97	90	
F	93-95	90 Todos	
F	88-91	90 Todos	

Lista numérica

Amort.	POP	No. Alternativo	Montaje Accesorio
Pos.	Año	Aplicación	
G44902	A	-continued	142717
F	93-95	90 QUATTRO Todos	
F	88-91	90 QUATTRO Todos	
F	80-87	4000 Todos	
F	84-87	4000 QUATTRO Todos	
F	83-87	COUPE Todos	
F	90-91	COUPE QUATTRO Todos	
F	73-79	FOX Todos	
F	84-88	VOLKSWAGEN CORSAR	
F	87-93	FOX Todos	
F	98-08	POINTER Todos	
F	98-08	POINTER PICK UP	
F	82-88	QUANTUM Todos	
F	86	VARIANT	
G44903	D		141070
F	93	ASUNA GT, SE+C487 Todos	
F	93	SE Todos	
F	99-02	DAEWOO LANOS Todos	
F	88-93	PONTIAC LEMANS Todos	
G44920	W		141769
F	82-88	BMW 528E Todos Sistema Autonivelable	
F	83-84	533i Todos Sistema Autonivelable	
F	85-88	535i Todos Sistema Autonivelable	
F	88	535iS Todos Sistema Autonivelable	
F	85-89	635CSI Todos Exc. Sistema de Autonivelación	
G44926	W		141845
F	81-92	TOYOTA CRESSIDA Todos Exc. Suspensión Electrónica Ajustable	
G44934	D		141796
F	85-88	NISSAN 200SX Todos	
F	84	200SX Todos Eje Delantero Rígido	
F	86-87	SAKURA	
G44936	W		141039
F	84-86	NISSAN 300ZX Todos	
G44937	X		141070
F	87-89	CHRYSLER CONQUEST Todos Exc. Suspensión Electrónica Ajustable	
F	87-89	MITSUBISHI STARION Todos Exc. Suspensión Electrónica Ajustable	
G44938	D		142256
F	76-85	TOYOTA CELICA Todos	
F	75	CELICA Todos Fab. hasta 10/75	
F	84-87	COROLLA Coupe, Standard, Rack (SteeringType)	
F	75-83	COROLLA Todos	
F	74	COROLLA Todos Fab. desde 8/74	
F	86	SUPRA Todos Fab. hasta 3/86	
G44939	W		143011
F	88-89	TOYOTA CELICA AWD	
F	86-87	CELICA Todos Exc. Todos-Trac	
F	87-88	COROLLA FX16, Hatchback Struts Delanteros Reconstruibles	
F	84-85	COROLLA 4x2 Tracción delantera, DIESEL	
G44940	D		141768
F	83-86	TOYOTA CAMRY Todos	
G44941	W		142284
F	84-92	VOLVO 740 / 745 / 760 / 780 Todos Fab. desde 5/84; Exc. Sistema de Nivelación Hidráulica	
F	89	740 / 745 / 760 / 780 Todos Exc. Sistema de Autonivelación NIVOMAT	
F	91-95	940 Todos Exc. Sistema de Autonivelación NIVOMAT	
F	92-95	960 Todos Fab. hasta 10/94 Exc. Sistema Autonivelación NIVOMAT	
G44943	X		141039
R	87-89	TOYOTA MR2 Todos	
G44944	D		141975
F	86-89	HYUNDAI EXCEL Todos Struts Delanteros Reconstruibles de EO	
F	87-89	MITSUBISHI PRECIS Todos Struts Delanteros Reconstruibles de EO	
G44968	W		141039
F	87-89	NISSAN 300ZX Todos	
G44969	X		143075
F	88-90	BMW 735i Todos	
F	88-92	735iL Todos	

Lista numérica

Cartuchos de Strut Ultra, Amortiguadores de Aire HiJackers

Lista numérica

Amort.	POP	No. Alternativo	Montaje Accesorio
Pos.	Año	Aplicación	
G44982	D		141039
F 87-91	TOYOTA CAMRY	Todos Struts Delanteros Reconstruibles de EO	
F 88-89	CELICA GT Exc.	Todos-Trac	
F 88-89	CELICA GTS Exc.	Todos-Trac	
F 88-89	CELICA ST Exc.	Todos-Trac	
G44986	D		142717
F 86	VOLKSWAGEN PASSAT		
F 90-97	PASSAT	Todos Struts Delanteros Reconstruibles de EO	
G44990	D		141923
R 89-94	NISSAN MAXIMA	Todos Exc. Suspensión Electrónica Ajustable	
R 90-92	STANZA	Todos	
G44991	X		141742
F 86	BMW 525i		
F 90	525i	Todos Fab. hasta 8/90	
F 89	525i	Todos	
F 90	535i	Todos Fab. hasta 8/90	
F 89	535i	Todos	
F 88	535i	Todos Exc. Sistema de Autonivelación	
F 88	535iS	Todos Exc. Sistema de Autonivelación	
G44994	W		141039
F 88-91	TOYOTA COROLLA	Wagon	
G44995	C		141039
F 92-93	TOYOTA CELICA GT		
F 92-93	CELICA GTS		
F 92-93	CELICA ST		
F 90-91	CELICA	Todos	
G44997	W		141039
R 92-95	TOYOTA MR2	Todos	
G44998	W		141039
F 92-95	TOYOTA MR2	Todos	
G44999	D		141039
F 92-94	TOYOTA CAMRY	4x2 Tracción delantera Struts Reconstruibles de EO	
G244002	N		
F 99-02	SAAB 9-3	Todos	
Amortiguadores de Aire HiJackers			
49105	W		140121,141099
R 75-80	AMERICAN MOTORS PACER	Todos	
R 52-59	FORD COUNTRY SEDAN	Todos	
R 52-56	COUNTRY SQUIRE	Todos	
R 54-56	COURIER SEDAN DELIVERY	Todos	
R 52-54	CRESTLINE	Todos	
R 57	CUSTOM	Todos	
R 52	CUSTOM	Todos	
R 58	CUSTOM 300	Todos	
R 52-56	CUSTOMLINE	Todos	
R 62-70	FAIRLANE	Todos	
R 55-58	FAIRLANE	Todos	
R 60-70	FALCON	Todos	
R 52-56	MAINLINE	Todos	
R 65-73	MUSTANG / MUSTANG II	Todos	
R 60-65	RANCHERO	Todos	
R 52-56	RANCH WAGON	Todos	
R 54-56	SKYLARK	Todos	
R 52-58	SUNLINER	Todos	
R 55-57	THUNDERBIRD	Todos	
R 68-71	TORINO	Todos	
R 52-58	VICTORIA	Todos	
R 62-64	JAGUAR XKE	Todos	
R 79-83	MAZDA GLC Wagon		
R 78	GLC	Todos	
R 75-76	RX3 Wagon Exc.	Modelos c/ Struts Tokico de EO	
R 72-74	RX3	Todos	
R 74-78	RX4	Todos	
R 59-60	MERCURY COLONY PARK	Todos	
R 68-69	COMET	Todos	
R 66-67	COMET Convertible		
R 66-67	COMET Hardtop		
R 66-67	COMET Sedan		
R 60-65	COMET	Todos	
R 59-60	COMMUTER	Todos	
R 67-73	COUGAR	Todos	
R 59-60	COUNTRY CRUISER	Todos	
R 62-63	METEOR	Todos	
R 59-60	MONTCLAIR	Todos	
R 68-71	MONTEGO	Todos	
R 59-60	MONTEREY	Todos	

Amort.	POP	No. Alternativo	Montaje Accesorio
Pos.	Año	Aplicación	
49105	W	-continued	140121,141099
R 59-60	PARKLANE	Todos	
R 69-78	SAAB 99	Todos	
R 59-68	VOLVO 122	Todos	
49106	W		141099
R 65-69	CHRYSLER 300	Todos	
R 75-76	CORDOBA	Todos	
R 74-75	IMPERIAL	Todos	
R 74-78	NEWPORT	Todos	
R 65-69	NEWPORT	Todos	
R 74-78	NEW YORKER	Todos	
R 65-69	NEW YORKER	Todos	
R 74-78	TOWN & COUNTRY	Todos	
R 65-70	TOWN & COUNTRY	Todos	
R 63-64	DODGE 330	Todos	
R 63-64	440	Todos	
R 65	880	Todos	
R 70-74	CHALLENGER	Todos	
R 66-76	CHARGER	Todos	
R 65-76	CORONET	Todos	
R 62	DART	Todos	
R 74-78	MONACO	Todos	
R 73	MONACO	Todos Exc. Wagon	
R 72	MONACO	Todos	
R 65-70	MONACO	Todos	
R 73	POLARA	Todos Exc. Wagon	
R 72	POLARA	Todos	
R 62-70	POLARA	Todos	
R 75-77	ROYAL MONACO	Todos	
R 62-70	PLYMOUTH BELVEDERE	Todos	
R 62-63	FLEET SPECIAL	Todos	
R 77-78	FURY	Todos Paquete Policía	
R 74-76	FURY	Todos	
R 73	FURY Wagon		
R 62-69	FURY	Todos	
R 74-77	GRAN FURY	Todos	
R 73	GRAN FURY Wagon		
R 67	GTX	Todos	
R 68-75	ROADRUNNER	Todos	
R 65-74	SATELLITE	Todos	
R 62-64	SAVOY	Todos	
R 70	SUPERBIRD	Todos	
R 67	VIP	Todos	
49107	W		141099
R 69-72	CHEVROLET BLAZER	Todos Resorte Trasero	
R 67-72	PICKUP 1/2 TON, C10	Todos Resorte Trasero	
R 67-72	PICKUP 3/4 TON, C20	Todos Resorte Trasero	
R 68-72	SUBURBAN 1/2 TON, C10	Todos	
R 68-72	SUBURBAN 3/4 TON, C20	Todos	
R 67-72	VAN 1/2 TON, P SERIES	Todos	
R 70-72	GMC JIMMY	Todos 4x4	
R 67-72	PICKUP 1/2 TON, C15 / C1500	Todos Resorte Trasero	
R 67-72	PICKUP 3/4 TON, C25 / C2500	Todos Resorte Trasero	
R 68-72	SUBURBAN 1/2 TON, C15 / C1500	Todos Resorte Trasero	
R 68-72	SUBURBAN 3/4 TON, C25 / C2500	Todos Resorte Trasero	
R 68-72	VAN 1/2 TON, P SERIES	Todos Resorte Trasero	
49110	W		140377,141099
R 57-64	CHRYSLER 300	Todos	
R 55-56	NASSAU	Todos	
R 51-64	NEWPORT	Todos	
R 51-64	NEW YORKER	Todos	
R 57-60	SARATOGA	Todos	
R 51-52	SARATOGA	Todos	
R 55-56	ST REGIS	Todos	
R 51-64	TOWN & COUNTRY	Todos	
R 51-61	WINDSOR	Todos	
R 62-64	DODGE 880	Todos	
R 51-59	CORONET	Todos	
R 54-61	CUSTOM	Todos	
R 63-76	DART	Todos	
R 60-61	DART	Todos	
R 61-62	LANCER	Todos	
R 51-54	MEADOWBROOK	Todos	
R 60-61	POLARA	Todos	
R 64-69	PLYMOUTH BARRACUDA	Todos	
R 53-61	BELVEDERE	Todos	
R 51-53	CAMBRIDGE	Todos	
R 51-52	CONCORD	Todos	
R 51-53	CRANBROOK	Todos	
R 58-61	CUSTOM	Todos	
R 70-76	DUSTER	Todos	
R 60-61	FLEET SPECIAL	Todos	
R 56-61	FURY	Todos	
R 54-58	PLAZA	Todos	

Amort.	POP	No. Alternativo	Montaje Accesorio
Pos.	Año	Aplicación	
49110	W	-continued	140377,141099
R 53-61	SAVOY	Todos	
R 71-76	SCAMP	Todos	
R 60-61	SPORT WAGON	Todos	
R 51-61	SUBURBAN	Todos	
R 60-76	VALIANT	Todos	
49114	W		141150,141099
R 64-69	BUICK SPORTWAGON	Todos	
R 72	OLDSMOBILE CUTLASS / CUTLASS SUPREME	Cruiser	
R 64-72	VISTA CRUISER	Todos	
49122	W		140523,141099
R 68-70	CADILLAC ELDORADO	Todos Montado Verticalmente	
R 68-69	CHEVROLET CAMARO	Todos Resorte Trasero de Hoja Sencilla	
R 67	CAMARO	Todos	
R 66	OLDSMOBILE TORONADO	Todos Montado Verticalmente	
R 67	PONTIAC FIREBIRD	Todos	
49127	W		140739,141137,141099
R 78-79	FORD BRONCO	Todos Exc. Kit de Levantamiento	
R 67-77	BRONCO	Todos Desde Serie #830001; Exc. Kit de Levantamiento	
R 75-79	PICKUP 1 TON, F-350 / SUPERDUTY	Standard Cab Pickup, 4x2 Tracción trasera	
R 75-79	PICKUP 3/4 TON, F-250 / SUPERDUTY	Cab & Chassis, 4x2 Tracción trasera	
R 75-79	PICKUP 3/4 TON, F-250 / SUPERDUTY	Extended Cab Pickup, 4x2 Tracción trasera	
R 69-74	VAN 1/2 TON, ECONOLINE / CLUB WAGON	Todos	
R 69-74	VAN 1 TON, ECONOLINE / CLUB WAGON / SUPERDUTY	Todos	
R 69-74	VAN 3/4 TON, ECONOLINE / CLUB WAGON / SUPERDUTY	Todos	
R 76-83	JEEP CHEROKEE	Todos	
R 67	GLADIATOR	Todos	
R 84-91	GRAND WAGONEER	Todos	
R 74-88	J10 PICKUP	Todos	
R 74-88	J20 PICKUP	Todos	
R 68-73	J2500 PICKUP	Todos	
R 76-83	WAGONEER	Todos	
49128	W		140644,141099
R 70	BUICK ESTATE WAGON	Todos	
R 65-70	OLDSMOBILE 88 SERIES	Todos	
R 65-70	98	Todos	
R 67	CUTLASS / CUTLASS SUPREME	Turnpike Cruiser	
R 65-66	STARFIRE	Todos	
R 63-70	PONTIAC BONNEVILLE	Todos	
R 63-70	CATALINA	Todos	
R 67-70	EXECUTIVE	Todos	
R 63-68	GRAND PRIX	Todos	
R 63-66	STAR CHIEF	Todos	
49131	W		140630,141099
R 71-73	BUICK CENTURION	Todos	
R 71-84	ELECTRA	Todos	
R 71-85	LESABRE	Todos	
R 71-78	RIVIERA	Todos	
R 92-96	ROADMASTER	Sedan	
R 64-67	SKYLARK	Todos Exc. Suspensión HD	
R 64-67	SPECIAL	Todos Exc. Suspensión HD	
R 87-92	CADILLAC BROUGHAM	Todos	
R 92-96	COMMERCIAL CHASSIS 4x2	Tracción trasera	
R 77-84	COMMERCIAL CHASSIS	Todos	
R 77-84	DEVILLE	Todos	
R 93-96	FLEETWOOD 4x2	Tracción trasera	
R 77-86	FLEETWOOD 4x2	Tracción trasera	
R 81	CHEVROLET BEL AIR	Todos	
R 75	BEL AIR Sedan		
R 65-74	BEL AIR	Todos	
R 65-72	BISCAYNE	Todos	
R 69-70	BROOKWOOD	Todos	
R 81-96	CAPRICE Sedan Modelos Policía y Taxi		
R 75-80	CAPRICE Coupe		
R 75-80	CAPRICE Sedan		
R 75	CAPRICE Convertible		
R 73-74	CAPRICE Sedan Modelos Policía y Taxi		
R 71-72	CAPRICE Todos Modelos Policía y Taxi		
R 66-70	CAPRICE	Todos	

Lista numérica

Amort.	POP	No. Alternativo	Montaje Accesorio
Pos.	Año	Aplicación	
49131	W	-continued	140630,141099
R	64-67	CHEVELLE Todos Exc. Suspensión HD	
R	94-96	IMPALA Todos	
R	83-85	IMPALA Todos	
R	82	IMPALA Sedan	
R	74-81	IMPALA Coupe Exc. Wagon	
R	73-81	IMPALA Sedan Exc. Wagon	
R	73	IMPALA Hardtop Exc. Wagon	
R	70-72	IMPALA Sedan	
R	65-69	IMPALA Todos	
R	69-70	KINGSWOOD Todos	
R	64-67	MALIBU Todos Exc. Suspensión HD	
R	69-70	TOWNSMAN Todos	
R	71-85	OLDSMOBILE 88 SERIES Todos	
R	71-84	98 Todos	
R	66-67	CUTLASS / CUTLASS SUPREME Base Exc. Suspensión HD	
R	64-65	CUTLASS / CUTLASS SUPREME Todos Exc. Suspensión HD	
R	64-67	F85 Todos Exc. Suspensión HD	
R	71-81	PONTIAC BONNEVILLE Todos	
R	75-81	CATALINA Coupe	
R	71-81	CATALINA Sedan	
R	72-74	CATALINA Hardtop	
R	64-67	GTO Todos Exc. Suspensión HD	
R	76-81	LAURENTIAN Todos	
R	64-67	LEMANS Todos Exc. Suspensión HD	
R	76-86	PARISIENNE Sedan	
R	64-67	TEMPEST Todos Exc. Suspensión HD	
49135	W		140523,141099
R	70-81	CHEVROLET CAMARO Todos	
R	70-81	PONTIAC FIREBIRD Todos	
49149	W		141099
R	70-71	CHRYSLER 300 Todos	
R	67-73	IMPERIAL Todos	
R	70-73	NEWPORT Todos	
R	70-73	NEW YORKER Todos	
R	71-73	TOWN & COUNTRY Todos	
R	73	DODGE MONACO Todos Wagon	
R	71	MONACO Todos Wagon	
R	72-93	PICKUP 1/2 TON, D100 SERIES Todos	
R	72-93	PICKUP 1 TON, D300 SERIES Todos	
R	82-93	PICKUP 3/4 TON, D200 SERIES Todos	
R	81	PICKUP 3/4 TON, D200 SERIES Todos Exc. Paquete HD	
R	72-80	PICKUP 3/4 TON, D200 SERIES Todos	
R	73	POLARA Todos Wagon	
R	71	POLARA Todos Wagon	
R	76-93	RAMCHARGER 4x2 Tracción trasera	
R	74-75	RAMCHARGER Todos	
R	73	PLYMOUTH FURY Todos Exc. Wagon	
R	70-72	FURY Todos	
R	73	GRAN FURY Hardtop	
R	72	GRAN FURY Todos	
R	74-81	TRAILDUSTER Todos	
49151	W		141099
R	75-80	CHEVROLET LUV PICKUP Todos	
R	72-74	LUV PICKUP Todos	
R	75-80	DODGE COLT Wagon	
R	71-74	COLT Todos	
R	76-80	PLYMOUTH COLT Todos	
R	74-76	TOYOTA CORONA Sedan	
R	73-76	CORONA Hardtop	
R	73	CORONA Sedan Fabricado desde 8/73	
R	69-71	CORONA Mark II, Sedan	
R	73-83	PICKUP 4x2 Tracción trasera Mojave	
R	70-72	PICKUP 4x2 Tracción trasera	
49152	W		140630,141099
R	73-77	BUICK CENTURY Todos	
R	71-83	ESTATE WAGON Todos	
R	65-67	GRAN SPORT Todos	
R	68-72	GS / GS350 / GS400 / GS455 Todos	
R	73-77	REGAL Todos	
R	91-96	ROADMASTER Wagon	
R	68-72	SKYLARK Todos	
R	64-67	SKYLARK Todos Suspensión HD Exc. Sportwagon	
R	68-69	SPECIAL Todos	
R	64-67	SPECIAL Todos Suspensión HD Exc. Sportwagon	
R	70-72	SPORTWAGON Todos	

Amortiguadores de Aire HiJackers

Amort.	POP	No. Alternativo	Montaje Accesorio
Pos.	Año	Aplicación	
49152	W	-continued	140630,141099
R	71-96	CHEVROLET CAPRICE Wagon	
R	68-73	CHEVELLE Todos	
R	64-67	CHEVELLE Todos Suspensión HD	
R	68-77	EL CAMINO Todos	
R	71-82	IMPALA Wagon	
R	73-77	MALIBU Todos	
R	64-67	MALIBU Todos Suspensión HD	
R	70-72	MONTE CARLO Todos	
R	71-77	GMC SPRINT / CABALLERO Todos	
R	75-76	NISSAN 610 Wagon	
R	73-74	610 Todos	
R	74-77	710 Wagon	
R	78-80	810 Wagon	
R	77-92	OLDSMOBILE CUSTOM CRUISER Todos	
R	76-77	CUTLASS / CUTLASS SUPREME Coupe	
R	76-77	CUTLASS / CUTLASS SUPREME Sedan	
R	73-75	CUTLASS / CUTLASS SUPREME Todos	
R	72	CUTLASS / CUTLASS SUPREME Base	
R	72	CUTLASS / CUTLASS SUPREME S	
R	68-71	CUTLASS / CUTLASS SUPREME Todos Exc. Vista Cruiser	
R	64-67	CUTLASS / CUTLASS SUPREME Todos Suspensión HD Exc. Vista Cruiser	
R	68-72	F85 Todos	
R	64-67	F85 Todos Suspensión HD	
R	71-78	TORONADO Todos	
R	77-81	PONTIAC CATALINA Wagon	
R	71-75	CATALINA Wagon	
R	73-75	GRAND AM Todos	
R	75-77	GRAND LEMANS Todos	
R	71-78	GRAND SAFARI Todos	
R	71-75	GRANDVILLE Todos	
R	68-73	GTO Todos	
R	64-67	GTO Todos Suspensión HD	
R	64-67	LEMANS Todos Suspensión HD	
R	80-86	PARISIENNE Wagon	
R	76-79	PARISIENNE Todos Wagon	
R	87-89	SAFARI Todos	
R	68-70	TEMPEST Todos	
R	64-67	TEMPEST Todos Suspensión HD	
49155	W		140702,141099
R	87-91	CHEVROLET BLAZER Todos Automóvil Grande; Exc. Suspensión Quad y Kit de Levantamiento	
R	73-86	BLAZER Todos Exc. Kit de Levantamiento	
R	73-86	PICKUP 1/2 TON, C10 Todos	
R	81-86	PICKUP 1/2 TON, K10 Todos Suspensión Estándar; Exc. Kit de Levantamiento	
R	73-80	PICKUP 1/2 TON, K10 Todos Exc. Kit de Levantamiento	
R	87	PICKUP 1/2 TON, R10 Todos	
R	87	PICKUP 1/2 TON, V10 Todos	
R	75-86	PICKUP 3/4 TON, C20 Standard Cab Pickup	
R	73-74	PICKUP 3/4 TON, C20 Todos Standard Cab Pickup	
R	81-86	PICKUP 3/4 TON, K20 Todos Suspensión Estándar; Exc. Kit de Levantamiento	
R	73-80	PICKUP 3/4 TON, K20 Todos Exc. Kit de Levantamiento	
R	87	PICKUP 3/4 TON, R20 Standard Cab Pickup	
R	87	PICKUP 3/4 TON, V20 Todos	
R	73-86	SUBURBAN 1/2 TON, C10 Todos	
R	81-86	SUBURBAN 1/2 TON, K10 Todos Suspensión Estándar; Exc. Kit de Levantamiento	
R	73-80	SUBURBAN 1/2 TON, K10 Todos Exc. Kit de Levantamiento	
R	87-88	SUBURBAN 1/2 TON, R10 Todos	
R	89-91	SUBURBAN 1/2 TON, R1500 Todos	
R	89-91	SUBURBAN 1/2 TON, V1500 Todos	
R	73-86	SUBURBAN 3/4 TON, C20 Todos	
R	81-86	SUBURBAN 3/4 TON, K20 Todos Suspensión Estándar; Exc. Kit de Levantamiento	
R	73-80	SUBURBAN 3/4 TON, K20 Todos Exc. Kit de Levantamiento	
R	87-88	SUBURBAN 3/4 TON, R20 Todos	
R	89-91	SUBURBAN 3/4 TON, R2500 Todos	
R	87-88	SUBURBAN 3/4 TON, V20 Todos	
R	89-91	SUBURBAN 3/4 TON, V2500 Todos	
R	73	VAN 1/2 TON, P SERIES Todos	
R	73-78	VAN 3/4 TON, P SERIES Todos	

Lista numérica

Amort.	POP	No. Alternativo	Montaje Accesorio
Pos.	Año	Aplicación	
49155	W	-continued	140702,141099
R	73-91	GMC JIMMY Todos Exc. Kit de Levantamiento	
R	73-86	PICKUP 1/2 TON, C15 / C1500 Todos	
R	73-86	PICKUP 1/2 TON, K15 / K1500 Todos Exc. Suspensión Quad y Kit de Levantamiento	
R	87	PICKUP 1/2 TON, R1500 Todos	
R	87	PICKUP 1/2 TON, V1500 Todos Suspensión Quad Exc. Kit de Levantamiento	
R	75-86	PICKUP 3/4 TON, C25 / C2500 Cab & Chassis	
R	75-86	PICKUP 3/4 TON, C25 / C2500 Standard Cab Pickup	
R	73-74	PICKUP 3/4 TON, C25 / C2500 Todos	
R	73-86	PICKUP 3/4 TON, K25 / K2500 Todos Exc. Suspensión Quad y Kit de Levantamiento	
R	88-89	PICKUP 3/4 TON, R2500 Todos Exc. Crew Cab y Bonus Cab	
R	87	PICKUP 3/4 TON, R2500 Cab & Chassis Exc. Crew Cab y Bonus Cab	
R	87	PICKUP 3/4 TON, R2500 Standard Cab Pickup Exc. Crew Cab y Bonus Cab	
R	87	PICKUP 3/4 TON, V2500 Todos Exc. Kit de Levantamiento	
R	73-86	SUBURBAN 1/2 TON, C15 / C1500 Todos	
R	73-86	SUBURBAN 1/2 TON, K15 / K1500 Todos Exc. Suspensión Quad y Kit de Levantamiento	
R	87-91	SUBURBAN 1/2 TON, R1500 Todos	
R	87-91	SUBURBAN 1/2 TON, V1500 Todos Exc. Kit de Levantamiento	
R	73-86	SUBURBAN 3/4 TON, C25 / C2500 Todos	
R	73-86	SUBURBAN 3/4 TON, K25 / K2500 Todos Exc. Suspensión Quad y Kit de Levantamiento	
R	87-91	SUBURBAN 3/4 TON, R2500 Todos	
R	87-91	SUBURBAN 3/4 TON, V2500 Todos Exc. Kit de Levantamiento	
R	73	VAN 1/2 TON, P SERIES Todos	
R	73-78	VAN 3/4 TON, P SERIES Todos	
49157	X		140629,141099
R	73	BUICK APOLLO Todos Suspensión HD	
R	68	CHEVROLET CHEVY II Todos Resorte Trasero de Hojas Múltiples	
R	73	NOVA Todos Suspensión HD	
R	69-72	NOVA Todos Resorte Trasero de Hojas Múltiples	
R	73	PONTIAC VENTURA Todos Suspensión HD	
R	71-72	VENTURA Todos Resorte Trasero de Hojas Múltiples	
49162	W		141058,141099
R	69-72	CHEVROLET BLAZER Todos Resorte Trasero de Hojas Múltiples	
R	63-72	PICKUP 1/2 TON, C10 Todos Resorte Trasero de Hojas Múltiples	
R	67-72	PICKUP 1 TON, C30 Todos Exc. Eje Trasero 11,000#	
R	67-72	PICKUP 3/4 TON, C20 Todos Resorte Trasero de Hojas Múltiples	
R	63-66	PICKUP 3/4 TON, C20 Todos	
R	63-66	SUBURBAN 1/2 TON, 1500 Todos	
R	67-77	VAN 1/2 TON, G / EXPRESS Todos	
R	63-66	VAN 1/2 TON, P SERIES Todos	
R	76-77	VAN 1 TON, G / EXPRESS Todos	
R	75	VAN 1 TON, G / EXPRESS 110.0 (WheelBase)	
R	75	VAN 1 TON, G / EXPRESS 125.0 (WheelBase)	
R	71-74	VAN 1 TON, G / EXPRESS Todos	
R	68-72	VAN 1 TON, P SERIES Todos Exc. Eje Trasero 11,000#	
R	67-77	VAN 3/4 TON, G / EXPRESS Todos	
R	68-72	VAN 3/4 TON, P SERIES Todos	
R	70-72	GMC JIMMY 4x2 Tracción trasera	
R	67-72	PICKUP 1/2 TON, C15 / C1500 Todos Resorte Trasero de Hojas Múltiples	
R	67-72	PICKUP 1 TON, C35/3500 Todos Exc. Eje Trasero 11,000#	
R	67-72	PICKUP 3/4 TON, C25 / C2500 Todos Resorte Trasero de Hojas Múltiples	

Lista numérica

Amort.	POP	No. Alternativo	Montaje Accesorio
Pos.	Año	Aplicación	
49162	W	-continued	141058,141099
R	63-65	PICKUP 1000 SERIES Todos	
R	63-65	PICKUP 1500 SERIES Todos	
R	67-77	VAN 1/2 TON, G / SAVANNA Todos	
R	67	VAN 1/2 TON, P SERIES Todos	
R	76-77	VAN 1 TON, G / SAVANNA Todos	
R	75	VAN 1 TON, G / SAVANNA 110.0 (WheelBase)	
R	75	VAN 1 TON, G / SAVANNA 125.0 (WheelBase)	
R	71-74	VAN 1 TON, G / SAVANNA Todos Exc. Base de rueda de 146"	
R	68-72	VAN 1 TON, P SERIES Todos Exc. Eje Trasero 11,000#	
R	67-77	VAN 3/4 TON, G / SAVANNA Todos	
R	68-72	VAN 3/4 TON, P SERIES Todos	
R	63-65	VAN, PB 1000 SERIES Todos	
49173	D		140126,141099
R	66	FORD BRONCO Todos Toda la serie #830000	
R	75-79	PICKUP 1/2 TON, F-100 4x2 Tracción trasera	
R	75-79	PICKUP 1/2 TON, F-150 4x2 Tracción trasera	
R	75-79	PICKUP 1 TON, F-350 / SUPERDUTY Cab & Chassis, 4x2 Tracción trasera	
R	75-79	PICKUP 1 TON, F-350 / SUPERDUTY Extended Cab Pickup, 4x2 Tracción trasera	
R	75-79	PICKUP 3/4 TON, F-250 / SUPERDUTY Standard Cab Pickup, 4x2 Tracción trasera	
R	75-91	VAN 1/2 TON, ECONOLINE / CLUB WAGON Todos	
49178	W		140126,141099
R	75-76	FORD PICKUP 1/2 TON, F-100 4x4 Exc. Kit de Levantamiento	
R	70-74	PICKUP 1/2 TON, F-100 Todos Exc. Kit de Levantamiento	
R	76-79	PICKUP 1/2 TON, F-150 4x4 Exc. Kit de Levantamiento	
R	75	PICKUP 1/2 TON, F-150 Todos 4x4; Exc. Kit de Levantamiento	
R	79	PICKUP 1 TON, F-350 / SUPERDUTY 4x4	
R	77-79	PICKUP 3/4 TON, F-250 / SUPERDUTY Cab & Chassis, 4x4 Aplica para toda la serie No. Y20001	
R	77-79	PICKUP 3/4 TON, F-250 / SUPERDUTY Cab & Chassis, 4x4 Todos desde Serie No. Y2001	
R	77-79	PICKUP 3/4 TON, F-250 / SUPERDUTY Standard Cab Pickup, 4x4 Aplica para toda la serie No. Y20001	
R	77-79	PICKUP 3/4 TON, F-250 / SUPERDUTY Standard Cab Pickup, 4x4 Todos desde Serie No. Y2001	
R	92-14	VAN 1/2 TON, ECONOLINE / CLUB WAGON Todos	
R	77-14	VAN 1 TON, ECONOLINE / CLUB WAGON / SUPERDUTY Todos	
R	07	VAN 1 TON, ECONOLINE / CLUB WAGON / SUPERDUTY Todos Exc. Cutaway Chassis	
R	07	VAN 1 TON, ECONOLINE / CLUB WAGON / SUPERDUTY Todos Exc. Paquete de Ambulancia y Manejo	
R	75-91	VAN 1 TON, ECONOLINE / CLUB WAGON / SUPERDUTY Todos Exc. Conversión Motorhome	
R	75-91	VAN 1 TON, ECONOLINE / CLUB WAGON / SUPERDUTY Todos Exc. Cutaway Chassis	
R	75-14	VAN 3/4 TON, ECONOLINE / CLUB WAGON / SUPERDUTY Todos	
49193	W		141035,141099
R	74-75	BUICK APOLLO Todos	
R	73	APOLLO Todos Exc. Suspensión HD	
R	75-79	SKYLARK Todos	
R	68	CHEVROLET CHEVY II Todos Resorte Trasero de Hoja Sencilla	
R	73	NOVA Todos Exc. Suspensión HD	
R	69-72	NOVA Todos Resorte Trasero de Hoja Sencilla	
R	74-77	OLDSMOBILE OMEGA Todos	
R	73	OMEGA Todos Exc. Suspensión HD	
R	77-79	PONTIAC PHOENIX Todos	
R	74-77	VENTURA Todos	

Amortiguadores de Aire HiJackers

Amort.	POP	No. Alternativo	Montaje Accesorio
Pos.	Año	Aplicación	
49193	W	-continued	141035,141099
R	73	VENTURA Todos Exc. Suspensión HD	
R	71-72	VENTURA Todos Resorte Trasero de Hoja Sencilla	
49196	W		140126,141099
R	87-88	FORD THUNDERBIRD Non-ABS	
R	80-86	THUNDERBIRD Todos	
R	82-87	LINCOLN CONTINENTAL Todos	
R	83-88	MERCURY COUGAR Todos	
R	80-82	COUGAR XR-7	
49197	W		141099
R	80-96	FORD BRONCO Todos Exc. Kit de Levantamiento	
R	80-83	PICKUP 1/2 TON, F-100 4x2 Tracción trasera	
R	80-84	PICKUP 1/2 TON, F-150 4x2 Tracción trasera	
49199	X		141282,141099
R	78-83	FORD FAIRMONT Todos	
R	81-82	GRANADA Todos	
R	83-86	LTD / COUNTRY SEDAN / COUNTRY SQUIRE / CROWN VICTORIA Todos	
R	84-93	MUSTANG / MUSTANG II LX, 2.3L 4Cyl L (140)	
R	85-86	MUSTANG / MUSTANG II 3.8L 6Cyl V (232)	
R	82-84	MUSTANG / MUSTANG II L	
R	84	MUSTANG / MUSTANG II LX, 3.8L 6Cyl V (232)	
R	82-83	MUSTANG / MUSTANG II GL	
R	82-83	MUSTANG / MUSTANG II GLX	
R	82	MUSTANG / MUSTANG II Ghia	
R	79-81	MUSTANG / MUSTANG II Todos	
R	79-86	MERCURY CAPRI Todos	
R	81-82	COUGAR Base	
R	82	COUGAR GS	
R	82	COUGAR LS	
R	83-86	MARQUIS Todos	
R	78-83	ZEPHYR Todos	
49203	W		142261,141099
R	82-02	CHEVROLET CAMARO Todos	
R	82-02	PONTIAC FIREBIRD Todos	
49205	D		141150,141099
R	65-74	FORD COUNTRY SEDAN Todos	
R	87-91	COUNTRY SQUIRE Todos	
R	65-74	COUNTRY SQUIRE Todos	
R	92-02	CROWN VICTORIA Todos	
R	65-72	CUSTOM Todos	
R	68-77	CUSTOM 500 Todos	
R	65-67	GALAXIE Todos	
R	68-74	GALAXIE 500 Todos	
R	84-94	GHIA	
R	01-02	GRAND MARQUIS Todos	
R	87-91	LTD / COUNTRY SEDAN / COUNTRY SQUIRE / CROWN VICTORIA Todos	
R	67-82	LTD / COUNTRY SEDAN / COUNTRY SQUIRE / CROWN VICTORIA Todos	
R	77-79	LTD II Todos	
R	72-79	RANCHERO Todos	
R	65-74	RANCH WAGON Todos	
R	77-79	THUNDERBIRD Todos	
R	67-72	THUNDERBIRD Todos	
R	72-76	TORINO Todos	
R	70-80	LINCOLN CONTINENTAL Todos	
R	68-71	MARK III Todos	
R	72	MARK IV Todos	
R	80-83	MARK VI Todos	
R	81-02	TOWN CAR Todos	
R	67	MERCURY BROUGHAM Todos	
R	87-91	COLONY PARK Todos	
R	65-74	COLONY PARK Todos	
R	65-68	COMMUTER Todos	
R	74-79	COUGAR Todos	
R	92-02	GRAND MARQUIS Todos Exc. Sistema de Autonivelación NIVOMAT	
R	75-91	GRAND MARQUIS Todos	
R	69-70	MARAUDER Todos	
R	65-67	MARAUDER Todos	
R	67-82	MARQUIS Todos	
R	65-68	MONTCLAIR Todos	
R	72-76	MONTEGO Todos	
R	65-74	MONTEREY Todos	
R	65-68	PARKLANE Todos	
R	65-67	VILLAGER Todos	
R	66-67	VOYAGER Todos	

Lista numérica

Amort.	POP	No. Alternativo	Montaje Accesorio
Pos.	Año	Aplicación	
49207	X		141099
R	89	FORD BRONCO II Todos Fab. hasta 2/89; Vehículos con perno 10mm y 12mm en montaje inferior trasero	
R	84-88	BRONCO II Todos Con Perno de 10mm en Montaje Inferior Trasero	
R	89	RANGER 4x2 Tracción trasera Fab. hasta 2/89; Vehículos con perno 10mm y 12mm en montaje inferior trasero	
R	83-88	RANGER 4x2 Tracción trasera	
49212	W		141099
R	78-95	CHEVROLET VAN 1/2 TON, G / EXPRESS Todos	
R	78-95	VAN 1 TON, G / EXPRESS Cutaway Van	
R	78-95	VAN 3/4 TON, G / EXPRESS Todos Exc. PBV 8600 #	
R	84-86	DODGE MINI RAM Todos	
R	99-03	VAN 1/2 TON, A / B SERIES / RAM 109.3 (WheelBase) Exc. PBV 7000#	
R	82-98	VAN 1/2 TON, A / B SERIES / RAM 109.6 (WheelBase) Exc. PBV 7000#	
R	71-80	VAN 1/2 TON, A / B SERIES / RAM Todos	
R	99-03	VAN 1 TON, A / B SERIES / RAM Todos	
R	95-98	VAN 1 TON, A / B SERIES / RAM Todos Exc. Eje Delantero 4000#	
R	71-94	VAN 1 TON, A / B SERIES / RAM Todos	
R	71-03	VAN 3/4 TON, A / B SERIES / RAM Todos	
R	78-80	VAN, CB300 Todos	
R	77	VAN, CB300 Todos PBV arriba de 8300#	
R	75-76	VAN, CB300 Todos	
R	74	VAN, CB300 Todos PBV arriba de 8300#	
R	78-95	GMC VAN 1/2 TON, G / SAVANNA Todos	
R	85-95	VAN 1 TON, G / SAVANNA Extended Cargo Van	
R	85-95	VAN 1 TON, G / SAVANNA Extended Passenger Van	
R	79-95	VAN 1 TON, G / SAVANNA Standard Cargo Van	
R	79-95	VAN 1 TON, G / SAVANNA Standard Passenger Van	
R	78	VAN 1 TON, G / SAVANNA Cutaway Van	
R	78-95	VAN 3/4 TON, G / SAVANNA Todos Exc. PBV 8600 #	
R	74-83	PLYMOUTH VAN 1/2 TON, PB SERIES Todos	
R	74-83	VAN 1 TON, PB SERIES Todos	
R	74-83	VAN 3/4 TON, PB SERIES Todos	
49213	D		141099
R	05	CHEVROLET BLAZER Base, 4x4	
R	05	BLAZER Base, 4x2 Tracción trasera	
R	96-04	BLAZER LS, 4x4	
R	96-04	BLAZER LS, 4x2 Tracción trasera	
R	95-02	BLAZER LT, 4x2 Tracción trasera	
R	95-01	BLAZER LT, 4x4	
R	95-99	BLAZER Base, 4x4	
R	95-99	BLAZER Base, 4x2 Tracción trasera	
R	95-97	BLAZER Deluxe, 4x2 Tracción trasera	
R	83-94	BLAZER, S MODELS Todos	
R	99-04	S10 LS, 4x4	
R	99-03	S10 Base, 4x4	
R	99-03	S10 Base, 4x2 Tracción trasera	
R	99-03	S10 LS, 4x2 Tracción trasera	
R	94-98	S10 LS	
R	82-98	S10 Base	
R	92-93	S10 EL	
R	83-92	S10 Tahoe	
R	88-90	S10 Durango	
R	82-86	S10 Durango	
R	05	GMC JIMMY 4x4	
R	92-04	JIMMY Todos	
R	83-91	S15 JIMMY Todos	
R	82-04	SONOMA / S15 Todos	
R	91	SYCLONE Todos	
R	92-93	TYPHOON Todos	
R	98-00	ISUZU HOMBRE Todos	
R	96-97	HOMBRE 4x2 Tracción trasera	
R	96-01	OLDSMOBILE BRAVADA Todos	
R	91-94	BRAVADA Todos	
49215	W		141099
R	90-05	CHEVROLET ASTRO Todos	
R	85-89	ASTRO 4x2 Tracción trasera	

Lista numérica

Amort.	POP	No. Alternativo	Montaje Accesorio
Pos.	Año	Aplicación	
49215	W	-continued	141099
R	90-05	GMC SAFARI Todos	
R	85-89	SAFARI 4x2 Tracción trasera	
R	86-89	VOLKSWAGEN VANAGON 4x4	
49216	X	141665,140719,141099	
R	86-95	FORD SABLE	
R	86-95	TAURUS Wagon	
R	86-95	MERCURY SABLE Wagon	
49217	W	141099	
R	80-96	FORD PICKUP 1/2 TON, F-150 4x4 Exc. Kit de Levantamiento	
R	82-85	PICKUP 1 TON, F-350 / SUPERDUTY 4x4 Montaje Inferior Delantero Tipo Abrazadera Exc. Doble Rodado o Kit de Levantamiento	
R	80-81	PICKUP 1 TON, F-350 / SUPERDUTY 4x4	
R	86	PICKUP 3/4 TON, F-250 / SUPERDUTY 4x4	
R	82-85	PICKUP 3/4 TON, F-250 / SUPERDUTY 4x4 Montaje Inferior Delantero Tipo Abrazadera Exc. Doble Rodado o Kit de Levantamiento	
R	80-81	PICKUP 3/4 TON, F-250 / SUPERDUTY 4x4	
49218	W	141099	
R	88-99	CHEVROLET PICKUP 1/2 TON, C15 / C1500 Todos	
R	88-99	PICKUP 1/2 TON, K15 / K1500 Todos	
R	01-03	PICKUP 1 TON, C35/3500 Base Eje Delantero Rígido HD	
R	91-00	PICKUP 1 TON, C35/3500 Todos Eje Delantero Rígido HD	
R	88-90	PICKUP 1 TON, C35/3500 Extended Cab Pickup Eje Delantero Rígido HD	
R	88-90	PICKUP 1 TON, C35/3500 Standard Cab Pickup Eje Delantero Rígido HD	
R	88-00	PICKUP 1 TON, K35 / K3500 Todos	
R	88-00	PICKUP 3/4 TON, C25 / C2500 Todos	
R	88-00	PICKUP 3/4 TON, K25 / K2500 Todos	
R	88-99	GMC PICKUP 1/2 TON, C15 / C1500 Todos	
R	88-99	PICKUP 1/2 TON, K15 / K1500 Todos	
R	92-00	PICKUP 1 TON, C35/3500 Cab & Chassis Eje Delantero Rígido HD	
R	88-91	PICKUP 1 TON, C35/3500 Todos Eje Delantero Rígido HD	
R	88-00	PICKUP 1 TON, K35 / K3500 Todos	
R	88-00	PICKUP 3/4 TON, C25 / C2500 Todos	
R	88-00	PICKUP 3/4 TON, K25 / K2500 Todos	
49221	W	141099	
R	90-97	FORD AEROSTAR Todos	
R	89	AEROSTAR 4x2 Tracción trasera	
49222	W	141099	
R	87-95	JEEP WRANGLER YJ (Código plataforma del fabricante)	
49223	W	141099	
R	90	FORD BRONCO II Todos	
R	89	BRONCO II Todos Fab. desde 2/89; Vehículos con perno de 12mm en montaje inferior trasero	
R	06	RANGER 4x2 Tracción trasera, Coil (FrontSpringType)	
R	90-05	RANGER 4x2 Tracción trasera	
R	89	RANGER 4x2 Tracción trasera Fab. desde 2/89; Vehículos con perno de 12mm en montaje inferior trasero	
R	94-97	MAZDA B2300 4x2 Tracción trasera	
49225	X	140719,141099	
R	91-94	FORD EXPLORER Todos	
R	91-94	MAZDA NAVAJO Todos	
49226	D	141099	
R	84-01	JEEP CHEROKEE Todos	
R	84-90	WAGONEER Todos	
49228	W	143331,141248,141099	
R	00-05	BUICK LESABRE Todos sin conexión de aire OE Estilo	
R	06-11	LUCERNE Todos	

Amortiguadores de Aire HiJackers

Amort.	POP	No. Alternativo	Montaje Accesorio
Pos.	Año	Aplicación	
49228	W	-continued	143331,141248,141099
R	97-05	PARK AVENUE Todos sin conexión de aire OE Estilo	
R	95-99	RIVIERA Todos Debe usarse con el kit de mangueras incluido	
R	00-02	CADILLAC DEVILLE Todos Debe usarse con el kit de mangueras incluido	
R	06-11	DTS Todos	
R	98-04	SEVILLE Todos sin conexión de aire OE Estilo	
R	01-03	OLDSMOBILE AURORA Todos Debe usarse con el kit de mangueras incluido	
R	95-99	AURORA Todos Debe usarse con el kit de mangueras incluido	
R	05	PONTIAC BONNEVILLE Todos	
R	00-04	BONNEVILLE Todos Debe usarse con el kit de mangueras incluido	
49229	W	141099	
R	89-98	MAZDA MPV 4x2 Tracción trasera	
49230	D	141099	
R	05-07	BUICK TERRAZA 4x2 Tracción delantera Suspensión con Nivelación Nuemática; Exc. Suspensión Trasera Independiente	
R	05-08	CHEVROLET UPLANDER 4x2 Tracción delantera Suspensión con Nivelación Nuemática; Exc. Suspensión Trasera Independiente	
R	97-05	VENTURE 4x2 Tracción delantera	
R	97-04	OLDSMOBILE SILHOUETTE 4x2 Tracción delantera	
R	99-05	PONTIAC MONTANA 4x2 Tracción delantera Suspensión con Nivelación Nuemática; Exc. Suspensión Trasera Independiente	
R	97-98	TRANS SPORT Todos	
R	05-07	SATURN RELAY Todos	
49231	W	141099	
R	99-00	CADILLAC ESCALADE Todos	
R	92-94	CHEVROLET BLAZER 4x4 Automóvil Grande	
R	92-99	SUBURBAN 1/2 TON, C15 / C1500 Todos	
R	92-99	SUBURBAN 1/2 TON, K15 / K1500 Todos	
R	92-99	SUBURBAN 3/4 TON, C25 / C2500 Todos	
R	92-99	SUBURBAN 3/4 TON, K25 / K2500 Todos	
R	95-00	TAHOE Todos Old Body Style	
R	96-11	VAN 1/2 TON, G / EXPRESS Todos	
R	96-02	VAN 1 TON, G / EXPRESS Todos	
R	96-02	VAN 3/4 TON, G / EXPRESS Todos Exc. PBV 8600 #	
R	92-99	GMC SUBURBAN 1/2 TON, C15 / C1500 Todos	
R	92-99	SUBURBAN 1/2 TON, K15 / K1500 Todos	
R	92-99	SUBURBAN 3/4 TON, C25 / C2500 Todos	
R	92-99	SUBURBAN 3/4 TON, K25 / K2500 Todos	
R	96-11	VAN 1/2 TON, G / SAVANNA Todos	
R	97-02	VAN 1 TON, G / SAVANNA Todos	
R	96-02	VAN 3/4 TON, G / SAVANNA Todos Exc. PBV 8600 #	
R	92-99	YUKON Todos	
R	99	YUKON Denali, 4x4	
49232	D	140719,141099	
R	95-01	FORD EXPLORER Todos Exc. Suspensión Electrónica Ajustable	
R	01-05	EXPLORER SPORT TRAC Todos	
R	97-01	MERCURY MOUNTAINEER Todos Exc. Suspensión Electrónica Ajustable	
49233	D	141099	
R	95-03	FORD WINDSTAR Coil (RearSpringType)	
49234	W	140126,141099	
R	03-04	FORD MUSTANG / MUSTANG II Mach I	
R	94-04	MUSTANG / MUSTANG II Base	
R	94-04	MUSTANG / MUSTANG II GT	
R	04	MUSTANG / MUSTANG II GT Base	
R	04	MUSTANG / MUSTANG II GT Equipado	
R	01	MUSTANG / MUSTANG II GT Bullitt	
R	95	MUSTANG / MUSTANG II GTS	

Lista numérica

Amort.	POP	No. Alternativo	Montaje Accesorio
Pos.	Año	Aplicación	
49235	D	141099	
R	99-06	CHEVROLET PICKUP 1/2 TON, SILVERADO 1500 4x2 Tracción trasera Exc. Suspensión Electrónica Ajustable	
R	07	SILVERADO 1500 CLASSIC 4x2 Tracción trasera Exc. Suspensión Electrónica Ajustable	
R	94-01	DODGE PICKUP 1/2 TON, RAM 1500 Todos	
R	94-02	PICKUP 1 TON, RAM 3500 4x2 Tracción trasera Exc. Eje Delantero Rígido	
R	94-02	PICKUP 3/4 TON, RAM 2500 4x4, GAS Exc. PBV 8600 #	
R	94-02	PICKUP 3/4 TON, RAM 2500 4x2 Tracción trasera	
R	95-96	PICKUP 3/4 TON, RAM 2500 4x4, CNG Exc. PBV 8600 #	
R	99-07	GMC SIERRA 1500 4x2 Tracción trasera Exc. Suspensión Electrónica Ajustable	
49236	D	141099	
R	96-07	CHRYSLER TOWN & COUNTRY Todos	
R	01-03	VOYAGER / GRAND VOYAGER Todos Exc. Sistema de Autonivelación NIVOMAT	
R	00	VOYAGER / GRAND VOYAGER Todos	
R	96-07	DODGE CARAVAN / GRAND CARAVAN Todos Exc. Sistema de Autonivelación NIVOMAT	
R	96-00	PLYMOUTH VOYAGER / GRAND VOYAGER Non-ABS	
49237	D	142700,141099	
R	97-04	FORD LOBO PICK UP	
R	04	PICKUP 1/2 TON, F-150 4x2 Tracción trasera	
R	00-03	PICKUP 1/2 TON, F-150 Harley-Davidson Edition, 4x2 Tracción trasera	
R	99-03	PICKUP 1/2 TON, F-150 Lariat, 4x2 Tracción trasera	
R	99-03	PICKUP 1/2 TON, F-150 XL, 4x2 Tracción trasera	
R	99-03	PICKUP 1/2 TON, F-150 XLT, 4x2 Tracción trasera	
R	00	PICKUP 1/2 TON, F-150 Base, 4x2 Tracción trasera	
R	97-98	PICKUP 1/2 TON, F-150 4x2 Tracción trasera	
R	97-99	PICKUP 3/4 TON, F-250 / SUPERDUTY 4x2 Tracción trasera Hasta PBV 8500#	
49241	W	141099	
R	97	FORD PICKUP 3/4 TON, F-250 / SUPERDUTY 4x4 PBV arriba de 8500#	
R	87-96	PICKUP 3/4 TON, F-250 / SUPERDUTY 4x4	
49254	W	141572	
R	97-02	CADILLAC ELDORADO Todos Exc. Control de Manejo Electrónico	
49255	D	141099,143331	
R	00-05	BUICK LESABRE Todos Con Entradas de Aire de EO	
R	97-05	PARK AVENUE Todos Con Entradas de Aire de EO	
R	95-99	RIVIERA Todos Con Entradas de Aire de EO	
R	00-05	CADILLAC DEVILLE Todos Con Entradas de Aire de EO	
R	98-04	SEVILLE Todos Con Entradas de Aire de EO	
R	01-03	OLDSMOBILE AURORA Todos Con Entradas de Aire de EO	
R	95-99	AURORA Todos Con Entradas de Aire de EO	
R	00-04	PONTIAC BONNEVILLE Todos Con Entradas de Aire de EO	
49304	W	140733,141099	
R	63-82	CHEVROLET CORVETTE Todos	
49307	W	141099	
R	52-70	VOLKSWAGEN BEETLE	
R	69-73	FASTBACK Todos	
R	66-73	SQUAREBACK Todos	
R	74-79	SUPER BEETLE Todos	

Lista numérica

Amortiguadores de Aire HiJackers, Asiento de Resorte Ultra

Lista numérica

Amort.	POP	No. Alternativo	Montaje Accesorio
Pos.	Año	Aplicación	
49307	W	-continued	141099
R	71-73	SUPER BEETLE	Todos Montaje inferior con 3 pernos tipo brida
R	73-74	THING	Todos
49309	W		140523,141099
R	69-72	NISSAN 521 PICKUP	Todos
R	72-79	620 PICKUP	Todos
R	82-86	720 PICKUP 4x2	Tracción trasera
R	80-81	720 PICKUP	Todos
R	69-71	TOYOTA CORONA Mark II,	Wagon
49310	W		140788,141099
R	79-82	DODGE D50 4x2	Tracción trasera
R	87-93	PICKUP, RAM 50 4x2	Tracción trasera
R	83-86	PICKUP, RAM 50	Todos
R	55	FORD F SERIES	Todos F-100
R	68	INTERNATIONAL 908C	Todos
R	68	1000C	Todos
R	68	1100C	Todos Exc. Travelette c/ base de rueda de 166"
R	68	1200C	Todos Exc. Travelette c/ base de rueda de 166"
R	68	1300C	Todos Exc. Travelette c/ base de rueda de 166"
R	68-72	M1100 / M1200	Todos
R	69	M1400	Todos
R	72-83	JEEP CJ5	Todos Exc. Kit de Levantamiento
R	66-71	CJ5	Todos
R	72-75	CJ6	Todos Exc. Kit de Levantamiento
R	66-71	CJ6	Todos
R	76-86	CJ7	Todos Exc. Kit de Levantamiento
R	66-74	DJ5	Todos Exc. Kit de Levantamiento
R	66-68	DJ6	Todos
R	57-60	FC150	Todos
R	63-65	FC170	Todos
R	64-66	GLADIATOR	Todos
R	63	GLADIATOR	Todos Suspensión Delantera Independiente
R	70-73	JEEPSTER	Todos
R	81-85	SCRAMBLER / CJ8	Todos
R	61-67	UNIVERSAL	Todos
R	86-87	MAZDA B2000 4x2	Tracción trasera
R	87-93	B2200 4x2	Tracción trasera
R	87-93	B2600 4x2	Tracción trasera
R	95-96	MITSUBISHI MIGHTY MAX	Todos
R	83-94	MIGHTY MAX 4x2	Tracción trasera
R	87-90	VAN	Todos
R	78-81	NISSAN 510	Wagon
R	98-04	FRONTIER 4x2	Tracción trasera Exc. Desert Runner
R	83-84	MAXIMA	Wagon
R	87-94	PICKUP 4x2	Tracción trasera
R	65-93	PICKUP	
R	86	PICKUP 4x2	Tracción trasera Fabricado desde 8/86
R	79-82	PLYMOUTH ARROW	PICKUP Todos
R	77-78	TOYOTA CORONA	Wagon
R	69-74	LAND CRUISER	Todos Exc. Wagon
R	67-68	LAND CRUISER	Todos
R	85-95	PICKUP 4x2	Tracción trasera Exc. 1 Ton
R	84	PICKUP 4x2	Tracción trasera
R	84-88	VAN Leaf (RearSpringType)	
R	88	VAN WAGON	Todos
49311	W		141099
R	81-82	CHEVROLET LUV	PICKUP Todos
R	89-94	ISUZU AMIGO	Todos
R	81-95	PICKUP	Todos
R	84-86	TROOPER	Todos
R	83-89	MITSUBISHI MONTERO	Todos
R	97-99	MONTERO SPORT	Todos
R	82-86	NISSAN 720	PICKUP 4x4
R	00-04	FRONTIER Crew Cab	Pickup, 4x2 Tracción trasera con Desert Runner
R	98-04	FRONTIER 4x4	
R	98-99	FRONTIER 4x2	Tracción trasera Crew Cab con Desert Runner
R	87-95	PATHFINDER	Todos Exc. Suspensión Electrónica Ajustable
R	65-94	PICKUP	
R	76-87	TOYOTA LAND CRUISER	Todos
R	75	LAND CRUISER	Todos Fab. desde 1/75
R	69-74	LAND CRUISER	Todos Wagon
R	85-92	PICKUP 4x2	Tracción trasera 1 Ton
R	80-83	PICKUP 4x4	Exc. Kit de Levantamiento

Amort.	POP	No. Alternativo	Montaje Accesorio
Pos.	Año	Aplicación	
49334	D		140630,141099
R	78-81	BUICK CENTURY	Todos
R	78-87	REGAL	Todos
R	78-87	CHEVROLET EL CAMINO	Todos
R	78-83	MALIBU	Todos
R	73-88	MONTE CARLO	Todos
R	78-87	GMC SPRINT / CABALLERO 4x2	Tracción trasera
R	79-87	OLDSMOBILE CUTLASS / CUTLASS SUPREME	Todos
R	78-79	CUTLASS / CUTLASS SUPREME	Vista Cruiser
R	76-77	CUTLASS / CUTLASS SUPREME	Wagon
R	80-83	CUTLASS CLASSIC / CUTLASS	CRUISER Todos
R	82-86	PONTIAC BONNEVILLE	Todos
R	78-80	GRAND AM	Todos
R	78-83	GRAND LEMANS	Todos
R	69-87	GRAND PRIX	Todos
R	68-81	LEMANS	Todos
49345	W		141248,141099
R	79-85	BUICK RIVIERA	Todos
R	79-85	CADILLAC ELDRADO	Todos
R	80-85	SEVILLE	Todos
R	79-85	OLDSMOBILE TORONADO	Todos
49346	W		140873,141099
R	83-89	CHRYSLER FIFTH AVENUE	Todos
R	81-83	IMPERIAL	Todos
R	77-81	LEBARON	Todos Carrocería M
R	76-80	DODGE ASPEN	Todos
R	77-89	DIPLOMAT	Todos
R	80-83	MIRADA	Todos
R	88-89	PLYMOUTH CARAVELLE 4x2	Tracción trasera
R	78-81	CARAVELLE 4x2	Tracción trasera
R	82-89	GRAN FURY	Todos
R	76-80	VOLARE	Todos
49369	W		141099
R	84-93	CHRYSLER DAYTONA	Todos
R	83-84	E CLASS	Todos
R	85	EXECUTIVE LIMOUSINE	Todos
R	83-84	EXECUTIVE SEDAN	Todos
R	90-93	IMPERIAL	Todos Exc. Sistema de Autonivelación NIVOMAT
R	84-86	LASER	Todos
R	82-95	LEBARON	Todos
R	81	LEBARON	Todos Exc. Carrocería M
R	82-89	MAGNUM K	
R	88-93	NEW YORKER	Todos Exc. Sistema de Autonivelación NIVOMAT
R	83-87	NEW YORKER	Todos
R	86-88	TOWN & COUNTRY	Todos
R	82-83	DODGE 400	Todos
R	83-88	600	Todos
R	81-89	ARIES	Todos
R	89-93	DAYTONA ES	
R	89-90	DAYTONA ES Turbo	
R	87-88	DAYTONA Pacifica	
R	86	DAYTONA Turbo Z	
R	84-85	DAYTONA Turbo	
R	85-89	LANCER	Todos
R	87-94	SHADOW	Todos
R	89-95	SPIRIT	Todos
R	89-95	PLYMOUTH ACCLAIM	Todos
R	88	CARAVELLE 4x2	Tracción delantera
R	83-87	CARAVELLE	Todos
R	81-89	RELIANT	Todos
R	87-94	SUNDANCE	Todos
49370	D		141277,141099
R	82-96	BUICK CENTURY	Todos
R	80-85	SKYLARK	Todos
R	82-90	CHEVROLET CELEBRITY	Todos
R	80-85	CITATION / CITATION II	Todos
R	90-96	LUMINA APV	Todos
R	85-96	OLDSMOBILE CIERA / CUTLASS	CIERA Todos Exc. Suspensión Electrónica Ajustable
R	82-84	CIERA / CUTLASS CIERA	Todos
R	87-94	CUTLASS CLASSIC / CUTLASS	CRUISER Todos Exc. Suspensión Electrónica Ajustable
R	80-84	OMEGA	Todos
R	90-96	SILHOUETTE	Todos
R	89-91	PONTIAC 6000 4x2	Tracción delantera
R	82-88	6000	Todos
R	80-84	PHOENIX	Todos
R	90-96	TRANS SPORT	Todos
49371	W		141277,141099
R	93	ASUNA GT, SE+C487	Todos

Amort.	POP	No. Alternativo	Montaje Accesorio
Pos.	Año	Aplicación	
49371	W	-continued	141277,141099
R	93	SE	Todos
R	82-89	BUICK SKYLARK	Todos
R	86-94	SKYLARK	Todos
R	85-87	SOMERSET / SOMERSET REGAL	Todos
R	82-88	CADILLAC CIMARRON	Todos
R	92-94	CHEVROLET BERETTA	Base Exc. Suspensión FE7
R	87-91	BERETTA	Todos
R	82-94	CAVALIER	Todos
R	94	CORSICA	Base Exc. Suspensión FE7
R	92-93	CORSICA	Todos Exc. Suspensión FE7
R	87-91	CORSICA	Todos
R	92-94	OLDSMOBILE ACHIEVA	Todos
R	85-87	CALAIS	Todos
R	88-91	CUTLASS CALAIS	Todos
R	87-88	FIRENZA	Todos
R	84-86	FIRENZA	Todos Struts Reconstruibles de EO
R	82-83	FIRENZA	Todos
R	85-94	PONTIAC GRAND AM	Todos
R	82-85	J2000 / SUNBIRD	Todos
R	86-94	SUNBIRD	Todos
R	87-91	TEMPEST	Todos
49387	W		140921,141099
R	96-02	TOYOTA 4RUNNER	Todos
49388	W		140921,141099
R	90-95	TOYOTA 4RUNNER	Todos
49613	W		141514,141099
R	92-93	ASUNA SUNRUNNER	Todos
R	98-04	CHEVROLET TRACKER	Non-ABS
R	89-97	GEO TRACKER	Todos
R	94-97	PONTIAC SUNRUNNER	Todos
R	99-05	SUZUKI GRAND VITARA	Todos
R	89-98	SIDEKICK	Todos
R	99-04	VITARA	Todos
R	96-98	X-90	Todos
49614	W		142369,141099
R	95-98	BUICK SKYLARK	Todos
R	95-96	CHEVROLET BERETTA	Todos
R	95-96	CORSICA	Todos
R	95-98	OLDSMOBILE ACHIEVA	Todos Exc. Suspensión Electrónica Ajustable
R	95-98	PONTIAC GRAND AM	Todos Exc. Suspensión Electrónica Ajustable
49616	FF		
R	00-06	CHEVROLET SUBURBAN 1/2 TON,	1500 Todos
R	00-06	TAHOE	Todos
R	00-06	GMC YUKON	Todos
R	00-06	YUKON XL	
Asiento de Resorte Ultra			
G51006	D		142137,141947
R	77-87	VOLKSWAGEN ATLANTIC	
R	85-93	CABRIOLET	Todos
R	77-87	CARIBE	
R	80-84	JETTA	Todos
R	75-84	RABBIT	Todos
R	75-89	SCIROCCO	Todos
G51007	X		141191,141946
R	77-83	BMW 320I	Todos
G51013	X		141947,141265
R	88-92	AUDI 80	Todos
R	93-95	90	Todos
R	88-91	90	Todos
R	80-87	4000	Todos
R	83-87	COUPE	Todos
G51022	A		142386
R	94	VOLKSWAGEN DERBY	
R	95-99	DERBY	Todos
R	87-98	GOLF	
R	87-98	GTI	
R	93-98	JETTA A3	(Código plataforma del fabricante)
R	87-91	JETTA A2	(Código plataforma del fabricante)
G51030	X		141352,142386
R	87-93	VOLKSWAGEN FOX	Todos
G51031	X		142113
R	86-91	MAZDA RX7	Todos Exc. Suspensión Electrónica Ajustable

Lista numérica

Amort.	POP	No. Alternativo	Montaje Accesorio
Pos.	Año	Aplicación	
G51033	D		141265,142386
R	90-97	VOLKSWAGEN PASSAT Todos Struts Delanteros Reconstruibles de EO	
G51034	W		141544
R	86-89	ACURA INTEGRA Todos	
G51039	D		142093
R	94-97	FORD ASPIRE Non-ABS	
R	88-93	FESTIVA Todos	
G51046	W		142052
R	89-90	DODGE 2000 GTX Todos	
R	91-93	EAGLE 2000 GTX Todos	
R	90-94	TALON AWD Sistema Autonivelable	
R	90-94	MINI COOPER AWD	
R	90-92	GALANT AWD	
R	92-94	PLYMOUTH LASER AWD	
G51047	W		142101
R	83-87	DODGE CHARGER Todos	
R	81-90	OMNI Todos	
R	87-89	PLYMOUTH EXPO Todos	
R	81-90	HORIZON Todos	
R	85	TURISMO Todos	
R	83	TURISMO Todos	
G51060	W		141682
R	89-92	TOYOTA CRESSIDA Todos Exc. Suspensión Electrónica Ajustable	
G51063	D		142487
R	93-95	DODGE COLT Todos	
R	93-96	EAGLE SUMMIT Coupe	
R	93-96	SUMMIT Sedan	
R	97-02	MINI COOPER S Todos	
R	96	MIRAGE Todos Fab. hasta 5/96	
R	93-95	MIRAGE Todos	
R	93-94	PLYMOUTH COLT Sedan	
G51077	B		142467
F	96-02	TOYOTA 4RUNNER Todos	
F	98-04	TACOMA Pre Runner	
F	95-04	TACOMA 4x4	
G51078	D		142154
R	95-98	CHRYSLER CIRRUS Todos	
R	96-98	SEBRING Convertible	
R	95-98	DODGE STRATUS Todos	
R	96-98	PLYMOUTH BREEZE Todos	
G51087	C		142106
R	96-99	MINI COOPER S Todos	
R	95-99	MINI COOPER R Todos	
G51097	D		
F	96-99	AUDI A4 Base Exc. Suspensión Deportiva	
F	96-00	A4 QUATTRO Base Fab. hasta 11/00 Exc. Suspensión Deportiva	
F	98-01	VOLKSWAGEN PASSAT 4x2 Tracción delantera Desde Número de Identificación de Vehículo (VIN) #3B300001 al #3B300000	
G51099	W		142154
F	98-99	AUDI A4 Avant Suspensión Deportiva	
F	96-97	A4 Todos Suspensión Deportiva	
F	98-00	A4 QUATTRO Avant Suspensión Deportiva	
F	96-97	A4 QUATTRO Todos Suspensión Deportiva	
F	99-00	A6 Avant Suspensión Deportiva	
F	98	A6 Todos Suspensión Deportiva	
G51100	W		
R	96-00	AUDI A4 Todos	
G51101	S		
F	98-04	AUDI A6 QUATTRO Todos	
G51161	W		
R	72-86	JAGUAR XJ6 Todos 4 amortiguadores requeridos	
R	81-92	XJ12 Todos 4 amortiguadores requeridos	
R	73-79	XJ12 Todos 4 amortiguadores requeridos	
R	76-96	XJS Todos	
G51170	D		141544
R	85-87	HONDA CIVIC Hatchback	
R	85-87	CIVIC Sedan	
R	85-87	CIVIC Wagon, 4x2 Tracción delantera	

Asiento de Resorte Ultra

Amort.	POP	No. Alternativo	Montaje Accesorio
Pos.	Año	Aplicación	
G51170	D	-continued	141544
R	84	CIVIC Todos	
G51173	W		142094
R	85-89	SUBARU DL Sedan, 4x2 Tracción delantera Exc. Suspensión de Aire	
R	85-89	GL Sedan, 4x2 Tracción delantera Exc. Suspensión de Aire	
R	90-93	LOYALE Sedan, 4x2 Tracción delantera Exc. Suspensión de Aire	
R	90	LOYALE Coupe, 4x2 Tracción delantera Exc. Suspensión de Aire	
R	85-91	XT 4x2 Tracción delantera, Coil (RearSpringType) Exc. Suspensión de Aire	
G51180	D		142099
R	87-90	TOYOTA TERCEL Hatchback	
R	87-90	TERCEL Sedan	
G51183	W		142094
R	85-89	SUBARU DL Wagon, 4x2 Tracción delantera Exc. Suspensión de Aire	
R	89	GL Wagon, 4x2 Tracción delantera Exc. Suspensión de Aire	
R	85-87	GL Wagon, 4x2 Tracción delantera Exc. Suspensión de Aire	
R	94	LOYALE Todos Exc. Suspensión de Aire	
R	90-93	LOYALE Wagon Exc. Suspensión de Aire	
G51184	D		142052
R	90-94	EAGLE TALON 4x2 Tracción delantera	
R	90-94	MINI COOPER S 4x2 Tracción delantera	
R	90-94	PLYMOUTH LASER 4x2 Tracción delantera	
G51186	W		142094
R	89-94	HYUNDAI SONATA Todos	
G51188	W		142113
F	90-96	NISSAN 300ZX 2+2 Izquierdo Exc. model spec VG30DETT	
G51189	W		142113
F	90-96	NISSAN 300ZX 2+2 Derecho Exc. model spec VG30DETT	
G51190	D		141716
R	90-96	NISSAN 300ZX 2+2 Exc. model spec VG30DETT	
G51191	D		141716
R	89-94	NISSAN 240SX Todos Exc. Suspensión Activa	
G51192	X		142097
R	88-91	MAZDA 929 Todos Exc. Suspensión Electrónica Ajustable	
G51193	W		142113
R	87-91	TOYOTA SUPRA Todos Exc. Suspensión Electrónica Ajustable	
R	86	SUPRA Todos Fab. desde 3/86; Exc. Suspensión Electrónica Ajustable	
G51195	W		141716
F	90-97	MAZDA MIATA Non-ABS	
G51196	W		141716
R	90-97	MAZDA MIATA Non-ABS	
G51197	W		142113
F	86-91	TOYOTA SUPRA Todos Exc. Suspensión Electrónica Ajustable	
G51204	D		
F	93-02	CHEVROLET CAMARO Todos	
F	93-02	PONTIAC FIREBIRD Todos	
G51216	W		
R	01-03	BMW 525i Sedan Exc. Suspensión Electrónica Ajustable	
R	99-00	528i Sedan	
R	97-98	528i Todos	
R	01-03	530i Todos Exc. Suspensión Electrónica Ajustable	
R	97-03	540i Sedan Exc. Suspensión Electrónica Ajustable	
R	95	540i Sedan Exc. Suspensión Electrónica Ajustable	

Lista numérica

Amort.	POP	No. Alternativo	Montaje Accesorio
Pos.	Año	Aplicación	
G51227	D		
F	95-99	KIA SPORTAGE Todos	
G51229	W		142721,141065
R	79-82	NISSAN 280ZX Todos	
R	77-81	810 Sedan	
R	79-80	810 Hardtop	
R	82-84	MAXIMA Sedan	
G51230	B		142106
R	95-98	NISSAN 200SX Todos Eje Trasero Rígido B14	
R	95	LUCINO	
R	96-00	LUCINO Todos	
R	95-00	SENTRA Todos Eje Trasero Rígido B14	
G51232	X		141065,142721
R	83	NISSAN 280ZX Todos	
G51249	W		142052
R	89-92	DODGE COLT Hatchback	
R	92	EAGLE SUMMIT Hatchback	
R	92	SUMMIT Sedan	
R	89-91	SUMMIT Todos	
R	92-95	HYUNDAI ELANTRA Non-ABS	
R	89-92	MINI COOPER S Todos	
R	90-91	PLYMOUTH COLT Hatchback, 4x2 Tracción delantera	
R	89	COLT Hatchback	
G51252	D		142094
R	95-99	TOYOTA PASEO Todos	
R	95-99	TERCEL Todos	
G51253	D		142875
R	94-98	MINI COOPER S Todos	
G51254	D		142874
R	01-05	CHRYSLER SEBRING ST (Código plataforma del fabricante), Coupe	
R	95-00	SEBRING Coupe	
R	95-00	DODGE AVENGER Todos	
R	01-05	STRATUS ST (Código plataforma del fabricante), Coupe	
R	95-98	EAGLE TALON 4x2 Tracción delantera	
R	95-99	MINI COOPER S 4x2 Tracción delantera	
R	99-03	GALANT Todos	
G51255	C		141544
F	97-01	HONDA CR-V Todos	
G51256	C		141544
R	97-01	HONDA CR-V Todos	
G51264	D		142094
F	97-01	HONDA PRELUDE Todos	
G51267	A		142154
F	99-00	CHRYSLER CIRRUS J2 (Código plataforma del fabricante)	
F	01-06	SEBRING JR (Código plataforma del fabricante), Convertible	
F	01-05	SEBRING JR (Código plataforma del fabricante), Sedan	
F	99-00	SEBRING Convertible	
F	99-06	DODGE STRATUS Sedan	
F	99-00	PLYMOUTH BREEZE Todos Exc. Código de Fabricación de Carrocería JA	
G51268	B		142154
R	99-00	CHRYSLER CIRRUS Todos	
R	01-06	SEBRING JR (Código plataforma del fabricante), Convertible	
R	01-06	SEBRING JR (Código plataforma del fabricante), Sedan	
R	99-00	SEBRING Convertible	
R	99-06	DODGE STRATUS Sedan	
R	99-00	PLYMOUTH BREEZE Todos	
G51279	A		142094
R	00-06	NISSAN SENTRA Todos	
G51286	C		141544
R	02-06	HONDA CR-V Todos	
G51290	X		142094
R	95-98	HYUNDAI SONATA Todos	
G51295	B		141716
R	98-02	FORD FIESTA	
G51330	X		
R	85-86	BMW 524TD Todos	

Lista numérica

Amort.	POP	No. Alternativo	Montaje Accesorio
Pos.	Año	Aplicación	
G51330	X	-continued	
R	82-88	528E	Todos Sistema Autonivelable
R	83-84	533I	Todos Sistema Autonivelable
R	85-88	535I	Todos Sistema Autonivelable
R	88	535IS	Todos Sistema Autonivelable
R	85-89	635CSI	Todos Exc. Sistema de Autonivelación
G51346	W	142155	
R	91-95	BMW 525I	Todos
R	90	525I	Todos Fab. desde 8/90
R	89	525I	Todos
R	94-95	530I	Sedan
R	91-93	535I	Todos
R	90	535I	Todos Fab. desde 8/90
R	89	535I	Todos
R	88	535I	Todos Exc. Sistema de Autonivelación
R	88	535IS	Todos Exc. Sistema de Autonivelación
G51424	W	142052	
R	91-93	EAGLE 2000 GTX	Todos Exc. Sistema de Autonivelación
R	89-93	MITSUBISHI GALANT	4x2 Tracción delantera
R	85-88	GALANT	Todos Exc. Suspensión Electrónica Ajustable
R	89-90	SIGMA Non-ABS	Exc. Sistema de Autonivelación
G51477	B	143008	
F	01-07	TOYOTA SEQUOIA	Todos
F	00-06	TUNDRA	Todos
G51700	B	141544	
R	01-03	ACURA EL	Todos
R	01-02	HONDA CIVIC	Todos
G51703	B		
F	04-08	FORD LOBO PICK UP	
F	05-08	PICKUP 1/2 TON, F-150	4x2 Tracción trasera
F	04	PICKUP 1/2 TON, F-150	Lariat, 4x2 Tracción trasera
F	04	PICKUP 1/2 TON, F-150	STX, 4x2 Tracción trasera
F	04	PICKUP 1/2 TON, F-150	XL, 4x2 Tracción trasera
F	04	PICKUP 1/2 TON, F-150	XLT, 4x2 Tracción trasera
F	06-08	LINCOLN MARK LT	4x2 Tracción trasera
G51704	B		
F	04-08	FORD LOBO PICK UP	
F	04-08	PICKUP 1/2 TON, F-150	4x4
F	06-08	LINCOLN MARK LT	4x4
G51705	W	142094	
R	01-06	HYUNDAI SANTA FE	Todos
G51706	A		
R	02-10	NISSAN PLATINA	
R	03-08	RENAULT CLIO	
G51709	W	141682	
F	92-00	LEXUS SC300	Todos
F	92-00	SC400	Todos
G51710	W	141682	
R	92-00	LEXUS SC300	Todos
R	92-00	SC400	Todos
G51711	W		
F	87-94	JAGUAR XJ6	Todos Exc. Sistema de Autonivelación
F	94	XJ12	Todos Exc. Sistema de Autonivelación
G51712	D	142874	
R	95-98	EAGLE TALON AWD	
R	00-05	MITSUBISHI ECLIPSE	Todos
R	95-99	ECLIPSE AWD	
G51713	D	142094	
R	01-05	HYUNDAI SONATA	Todos
R	00	SONATA	Todos Fab. desde 4/00
R	01	XG300	Todos
R	02-05	XG350	Todos
R	01-06	KIA MAGENTIS	Todos
R	01-06	OPTIMA	Todos
G51714	D	141544	
F	01-05	HYUNDAI SONATA	Todos
F	00	SONATA	Todos Fab. desde 8/00
F	01-06	KIA MAGENTIS	Todos

Asiento de Resorte Ultra

Amort.	POP	No. Alternativo	Montaje Accesorio
Pos.	Año	Aplicación	
G51714	D	-continued 141544	
F	01-05	OPTIMA	Todos
G51715	C		
F	04-10	INFINITI QX56	Todos
F	05-15	NISSAN ARMADA	Todos Exc. Sistema de Autonivelación
F	04-15	TITAN	Todos
G51716	C	141544	
R	03-05	HONDA CIVIC	Todos
G51718	C		
F	04-07	BUICK RAINIER	Todos
F	03-06	CHEVROLET SSR	Todos
F	06-09	TRAILBLAZER LT	
F	02-09	TRAILBLAZER	Todos
F	06-08	TRAILBLAZER Base	
F	06-07	TRAILBLAZER A	
F	06-07	TRAILBLAZER B	
F	06-07	TRAILBLAZER LS	
F	06	TRAILBLAZER EXT	
F	06	TRAILBLAZER EXT B	
F	02-06	TRAILBLAZER EXT	Todos
F	02-09	GMC ENVOY	Todos
F	02-06	ENVOY XL	Todos
F	04-05	ENVOY XUV	Todos
F	03-08	ISUZU ASCENDER	Todos
F	02-04	OLDSMOBILE BRAVADA	Todos
F	05-09	SAAB 9-7X	Todos
G51719	D		
F	03-06	FORD EXPEDITION	4x2 Tracción trasera
F	03-06	LINCOLN NAVIGATOR	4x2 Tracción trasera
G51720	D		
F	03-06	FORD EXPEDITION	4x4
F	03-06	LINCOLN NAVIGATOR	4x4 Exc. Suspensión neumática
G51721	C	142154	
R	10	CHRYSLER 300	Todos Exc. Suspensión Nivomat
R	05-09	300 4x2	Tracción trasera Exc. Suspensión Nivomat
R	06-09	DODGE CHARGER	Todos Exc. Paquete Policía w/Suspensión Nivomat
R	05-08	MAGNUM	Todos Exc. Suspensión Nivomat
G51722	C		
F	02-03	FORD EXPLORER Eddie Bauer	Exc. Todos los Modelos Sport y Sport Trac
F	02-03	EXPLORER Limited	Exc. Todos los Modelos Sport y Sport Trac
F	02-03	EXPLORER Postal	Exc. Todos los Modelos Sport y Sport Trac
F	02-03	MERCURY MOUNTAINEER	Todos
G51723	C		
F	04-05	FORD EXPLORER Eddie Bauer	Exc. Todos los Modelos Sport y Sport Trac
F	04-05	EXPLORER Limited	Exc. Todos los Modelos Sport y Sport Trac
F	04-05	MERCURY MOUNTAINEER	Todos
G51724	C		
R	02-05	FORD EXPLORER Eddie Bauer	Exc. Todos los Modelos Sport y Sport Trac
R	02-05	EXPLORER Limited	Exc. Todos los Modelos Sport y Sport Trac
R	02-03	EXPLORER Postal	Exc. Todos los Modelos Sport y Sport Trac
R	02-05	MERCURY MOUNTAINEER	Todos
G51725	B		
R	02-06	NISSAN ALTIMA	Todos
G51727	D		
R	00-01	INFINITI I30	Todos
R	02-04	I35	Todos
R	00-03	NISSAN MAXIMA	Todos
G51728	B		
F	07-11	DODGE NITRO	Todos
F	02-12	JEEP LIBERTY	Todos
G51729	D		
R	03-06	FORD EXPEDITION	Todos
R	03-06	LINCOLN NAVIGATOR	Todos Exc. Suspensión Neumática

Lista numérica

Amort.	POP	No. Alternativo	Montaje Accesorio
Pos.	Año	Aplicación	
G51730	D		
R	01-06	NISSAN ALMERA	
G51733	D		
R	98-02	FORD FIESTA	
G51735	B		
R	01-02	SEAT CORDOBA	
R	99-02	IBIZA	
R	00-07	VOLKSWAGEN DERBY	
G51736	C		
R	03-08	PONTIAC VIBE	4x2 Tracción delantera
R	03-08	TOYOTA COROLLA	Todos
R	03-08	MATRIX	4x2 Tracción delantera
G51737	C	141544	
F	04-08	ACURA TL	Todos
F	04-08	TSX	Todos
F	06-07	HONDA ACCORD	Value Package
F	03-07	ACCORD EX	
F	03-07	ACCORD LX	
F	03-05	ACCORD DX	
F	05	ACCORD SE	
F	03	ACCORD Coupe	
G51738	C		
R	04-08	ACURA TL	Todos
R	06-07	HONDA ACCORD	Value Package
R	03-07	ACCORD EX	
R	03-07	ACCORD LX	
R	03-05	ACCORD DX	
R	05	ACCORD SE	
R	03	ACCORD Coupe	
G51739	C		
F	13-16	TOYOTA 4RUNNER	Todos
F	12	4RUNNER	Todos Exc. Suspensión X-REAS; Exc. Modelo Deportivos
F	10-11	4RUNNER Trail	Exc. Suspensión X-REAS
F	03-11	4RUNNER Limited	Exc. Suspensión X-REAS
F	03-11	4RUNNER SR5	Exc. Suspensión X-REAS
F	07-12	FJ CRUISER	Todos
F	05-13	TACOMA	4x4
F	05-13	TACOMA	Pre Runner
G51740	D	141682	
F	00-08	AUDI A4	Todos
F	05-08	A4 QUATTRO	Elite Fab. desde 11/00; Exc. Suspensión Deportiva
F	04-08	A4 QUATTRO	Cabriolet Fab. desde 11/00; Exc. Suspensión Deportiva
F	00-08	A4 QUATTRO	Base Fab. desde 11/00; Exc. Suspensión Deportiva
F	08	A4 QUATTRO S	Line Fab. desde 11/00; Exc. Suspensión Deportiva
F	08	A4 QUATTRO	Trendy Fab. desde 11/00; Exc. Suspensión Deportiva
F	06-07	A4 QUATTRO	DTM Fab. desde 11/00; Exc. Suspensión Deportiva
F	05-06	A4 QUATTRO S	Line Fab. desde 11/00; Exc. Suspensión Deportiva
F	06	A4 QUATTRO	Vanguard Fab. desde 11/00; Exc. Suspensión Deportiva
F	02-05	A4 QUATTRO	Luxury Fab. desde 11/00; Exc. Suspensión Deportiva
F	01	A4 QUATTRO	Confort Fab. desde 11/00; Exc. Suspensión Deportiva
G51742	D		
R	95-04	AUDI A6	QUATTRO Todos
R	01-05	VOLKSWAGEN PASSAT	AWD Exc. Número de Identificación de Vehículo (VIN) #3B300001 al #3B300000
R	98-00	PASSAT	4x2 Tracción delantera Exc. Número de Identificación de Vehículo (VIN) #3B300001 al #3B300000
G51744	D		
R	97-01	BMW 740I	Todos Exc. Suspensión Electrónica Ajustable
R	94-95	740I	Todos Exc. Suspensión Electrónica Ajustable
R	94-01	740IL	Todos Exc. Suspensión Electrónica Ajustable
R	94-96	750IL	Todos

Lista numérica

Amort.	POP	No. Alternativo	Montaje Accesorio
Pos.	Año	Aplicación	
G51746 D			
F	03-07	CADILLAC CTS Todos Exc. Suspensión Magnética de Control de Manejo	
G51747 A 141716			
R	06-11	CHEVROLET AVEO Todos	
R	04-15	AVEO Todos	
R	04-10	PONTIAC G3	
R	09-10	G3 Todos	
R	05-08	WAVE Todos	
G51756 D 140953			
F	00-04	LINCOLN LS Todos	
G51757 D			
R	00-06	LINCOLN LS Todos	
G51758 C			
F	06-08	DODGE PICKUP 1/2 TON, RAM 1500 4x4 Exc. Mega Cab	
G51759 W			
R	05	SATURN L / LS / LW SERIES Todos	
R	00-03	L / LS / LW SERIES Todos	
G51760 C 140953			
F	05-10	CHRYSLER 300 4x2 Tracción trasera Derecho	
F	06-10	DODGE CHARGER 4x2 Tracción trasera Derecho	
F	05-08	MAGNUM 4x2 Tracción trasera Derecho	
G51761 C 140953			
F	05-10	CHRYSLER 300 4x2 Tracción trasera Izquierdo	
F	06-10	DODGE CHARGER 4x2 Tracción trasera Izquierdo	
F	05-08	MAGNUM 4x2 Tracción trasera Izquierdo	
G51764 W 142106			
R	03-06	INFINITI G35 Todos Exc. Suspensión Deportiva	
R	03-06	NISSAN 350Z Coupe Exc. Suspensión Deportiva	
G51765 C			
F	12	NISSAN PATHFINDER Todos Fab. hasta 8/12	
F	05-11	PATHFINDER Todos	
F	13-15	XTERRA Todos	
F	12	XTERRA Todos Fab. hasta 12/12	
F	05-11	XTERRA Todos	
G51766 B			
F	16	NISSAN FRONTIER SV Exc. Nismo Off-Road	
F	15	FRONTIER SL Exc. Nismo Off-Road	
F	14	FRONTIER S Exc. Nismo Off-Road	
F	13	FRONTIER LE	
F	13	FRONTIER PRO-4X	
F	11-12	FRONTIER S	
F	12	FRONTIER LE Fab. hasta 12/12	
F	12	FRONTIER PRO-4X Fab. hasta 12/12	
F	12	FRONTIER SL Fab. hasta 12/12	
F	09-11	FRONTIER PRO-4X	
F	05-11	FRONTIER LE	
F	11	FRONTIER SL	
F	05-10	FRONTIER SE	
F	05-06	FRONTIER XE	
G51767 W			
R	03-06	SUBARU BAJA Todos	
R	00-04	OUTBACK Todos	
G51768 W 141682			
R	03-06	PONTIAC VIBE AWD	
R	03-06	TOYOTA MATRIX AWD	
G51769 W			
F	00-02	JAGUAR S TYPE Todos Fab. hasta 6un/02 Exc. Suspensión de tecnología computarizada activa (CATS)	
G51770 W			
F	02-05	FORD THUNDERBIRD Todos	
G51771 W			
R	02-05	FORD THUNDERBIRD Todos	
G51772 W			
R	97-03	MIITSUBISHI DIAMANTE Todos	

Asiento de Resorte Ultra

Amort.	POP	No. Alternativo	Montaje Accesorio
Pos.	Año	Aplicación	
G51773 W			
R	00-05	JAGUAR S TYPE Todos Fab. hasta 6un/02 Exc. Suspensión de tecnología computarizada activa (CATS)	
G51774 W			
F	04-06	KIA AMANTI Todos	
G51783 C			
R	06-13	TOYOTA YARIS Todos	
G51794 D			
R	02-07	MIITSUBISHI LANCER LS	
R	07	LANCER LS Diamond	
R	04-06	LANCER Ralliart	
R	02-06	LANCER OZ Rally	
R	06	LANCER DE	
R	06	LANCER SE	
R	04	LANCER DE	
R	04	LANCER Sportback	
G51795 D			
R	04-09	TOYOTA PRIUS Todos	
G51796 D			
F	97-98	CHRYSLER CIRRUS JA (Código plataforma del fabricante)	
F	97-98	SEBRING Convertible	
F	97-98	DODGE STRATUS Todos	
F	96-98	PLYMOUTH BREEZE JA (Código plataforma del fabricante)	
G51798 D 141682			
R	03-07	NISSAN MURANO Todos	
G51799 B			
R	10-12	AUDI A3 Todos Exc. S3 y suspensión electrónica	
R	04-08	A3 Todos Exc. S3 y suspensión electrónica	
R	08-11	SEAT LEON	
R	12-16	VOLKSWAGEN BEETLE Todos	
R	04-14	BORA	
R	09-12	CC Todos	
R	09-14	EOS Todos	
R	10-14	GOLF Todos Nuevo Modelo	
R	06-13	GTI Todos Nuevo Modelo	
R	06-13	JETTA A5 (Código plataforma del fabricante)	
R	12-14	PASSAT Todos	
R	10	PASSAT Todos	
R	09-16	PASSAT CC	
R	06-09	RABBIT Todos	
G51800 B			
R	06	FORD ECOSPORT	
R	04	ECOSPORT	
R	07-08	ECOSPORT	
R	05	ECOSPORT	
G51801 A			
R	03-10	FORD FIESTA	
G51802 D			
R	04-08	NISSAN MAXIMA Todos	
G51803 C			
R	04-09	NISSAN QUEST Todos	
G51804 D			
R	04-10	TOYOTA SIENNA 4x2 Tracción delantera 7 Pasajeros	
G51805 C			
R	04-10	TOYOTA SIENNA AWD	
R	04-10	SIENNA 4x2 Tracción delantera 8 Pasajeros	
G51806 D			
F	06-10	HYUNDAI AZERA Todos	
F	06-10	SONATA Todos	
G51807 B			
R	06-11	HONDA CIVIC Todos	
G51810 D			
F	03-08	MAZDA 6 Todos Izquierdo	
G51811 D			
F	03-08	MAZDA 6 Todos Derecho	
G51812 D			
R	03-06	INFINITI G35 Coupe Suspensión Deportiva	
R	03-05	NISSAN 350Z Todos Suspensión Deportiva	

Lista numérica

Amort.	POP	No. Alternativo	Montaje Accesorio
Pos.	Año	Aplicación	
G51813 D			
F	03-07	INFINITI G35 Coupe Izquierdo Suspensión Deportiva	
F	03-05	NISSAN 350Z Todos Izquierdo	
G51814 D			
F	03-07	INFINITI G35 Coupe Derecho Suspensión Deportiva	
F	03-05	NISSAN 350Z Todos Derecho	
G51815 B			
F	05-09	DODGE DAKOTA Todos	
F	06-09	MIITSUBISHI RAIDER Todos	
G51825 N 141716			
R	04-06	KIA AMANTI Todos	
G51826 N 141716			
R	95-02	MAZDA MILLENIA Todos	
G51827 D 141716			
F	97-02	MAZDA MILLENIA Todos Izquierdo	
G51828 D 141716			
F	97-02	MAZDA MILLENIA Todos Derecho	
G51829 N 141716			
R	96-04	ACURA RL Todos	
G51830 N			
R	02-04	ACURA RSX Todos	
G51831 N 141682			
R	03-08	INFINITI FX35 Todos	
R	03-08	FX45 Todos	
G51832 N			
F	01-06	LEXUS LS430 Todos	
G51833 N 141682			
R	01-06	LEXUS LS430 Todos	
G51834 N 141682			
F	01-04	LEXUS IS300 Todos	
G51835 N 141682			
R	01-04	LEXUS IS300 Todos	
G51836 D			
F	03-05	LINCOLN AVIATOR Todos	
G51837 D			
R	03-05	LINCOLN AVIATOR Todos	
G51838 D 141716			
R	03-04	MIITSUBISHI OUTLANDER Todos	
G51839 D 141716			
F	01-04	MIITSUBISHI MONTERO Todos Exc. Sport	
G51840 N 141682			
R	01-03	TOYOTA PRIUS Todos	
G51841 W			
R	01-04	VOLVO S40 Todos	
R	00	S40 Todos Fab. desde 4/00	
R	01-04	V40 Todos	
R	00	V40 Todos Fab. desde 4/00	
G51842 B 141716			
R	07-12	DODGE CALIBER Todos	
R	07-10	JEEP COMPASS Todos	
R	07-10	PATRIOT Todos	
G51847 N			
R	04-08	ACURA TSX Todos	
G51848 B			
R	09-10	DODGE JOURNEY 4x2 Tracción delantera	
G51849 D			
R	05-07	FORD FIVE HUNDRED 4x2 Tracción delantera	
R	05-07	MERCURY MONTEGO 4x2 Tracción delantera	
G51850 B			
F	04-12	CHEVROLET COLORADO 4x2 Tracción trasera, Coil (FrontSpringType) Exc. Paquete Z71 Off Road	
F	04-11	GMC CANYON 4x2 Tracción trasera, Coil (FrontSpringType) Exc. Paquete Z71 Off Road	
F	06	ISUZU I-280 4x2 Tracción trasera Exc. Paquete Z71 Off Road	

Lista numérica

Amort.	POP	No. Alternativo	Montaje Accesorio
Pos.	Año	Aplicación	
G51850	B	-continued	
F	07-08	I-290 4x2 Tracción trasera Exc. Paquete Z71 Off Road	
F	08	I-370 4x2 Tracción trasera, Coil (FrontSpringType) Exc. Paquete Z71 Off Road	
G51852	N		
R	05-10	SCION TC Todos	
G51853	D		
F	05-09	TOYOTA TACOMA Base, 4x2 Tracción trasera Izquierdo	
F	05-09	TACOMA X-Runner Izquierdo	
G51854	D		
F	05-09	TOYOTA TACOMA Base, 4x2 Tracción trasera Derecho	
F	05-09	TACOMA X-Runner Derecho	
G51855	C		
F	07-13	TOYOTA TUNDRA Todos	
G51856	C		
F	09-10	DODGE PICKUP 1/2 TON, RAM 1500 4x4	
F	11-14	RAM 1500	
F	11-15	RAM 1500 (SEE DODGE RAM 1500) 4x4	
G51857	D		
R	05-07	FORD FREESTYLE AWD	
R	08-09	TAURUS X AWD	
G51858	C		
R	03-11	HONDA ELEMENT Todos	
G51859	C		
F	06-09	FORD FUSION Todos	
F	07-09	LINCOLN MKZ Todos	
F	06	ZEPHYR Todos	
F	06-09	MERCURY MILAN Todos	
G51860	D		
F	07-13	FORD EXPEDITION Coil (RearSpringType) Exc. Suspensión de Aire	
F	07-13	LINCOLN NAVIGATOR Todos	
G51861	C		
R	07-16	FORD EXPEDITION Coil (RearSpringType) Exc. Suspensión de Aire	
R	07-16	LINCOLN NAVIGATOR Todos	
G51863	B		
R	11-14	CHRYSLER 200 Todos Suspensión Estándar	
R	07-10	SEBRING Todos	
R	08-14	DODGE AVENGER Todos	
G51864	B		
F	09-13	FORD LOBO PICK UP	
F	09-13	PICKUP 1/2 TON, F-150 4x4	
F	09-12	LINCOLN MARK LT	
G51865	B		
F	09-13	FORD LOBO PICK UP	
F	09-13	PICKUP 1/2 TON, F-150 4x2 Tracción trasera	
F	09-12	LINCOLN MARK LT	
G51868	FF		
F	96-02	TOYOTA 4RUNNER Todos	
F	95-04	TACOMA Todos	
G51869	FF		
F	01-07	TOYOTA SEQUOIA Todos	
F	00-06	TUNDRA Todos	
G51870	A		
F	07-13	CHEVROLET CHEYENNE	
F	08-13	PICKUP 1/2 TON, SILVERADO 1500 Todos Exc. Suspensión Electrónica Ajustable	
F	07	PICKUP 1/2 TON, SILVERADO 1500 Base Exc. Suspensión Electrónica Ajustable	
F	07	PICKUP 1/2 TON, SILVERADO 1500 LT Exc. Suspensión Electrónica Ajustable	
F	07	PICKUP 1/2 TON, SILVERADO 1500 LTZ Exc. Suspensión Electrónica Ajustable	
F	07	PICKUP 1/2 TON, SILVERADO 1500 WT Exc. Suspensión Electrónica Ajustable	

Asiento de Resorte Ultra

Amort.	POP	No. Alternativo	Montaje Accesorio
Pos.	Año	Aplicación	
G51870	A	-continued	
F	08-13	GMC SIERRA 1500 Todos Exc. Suspensión Electrónica Ajustable	
F	07	SIERRA 1500 SLE Exc. Suspensión Electrónica Ajustable	
F	07	SIERRA 1500 SLT Exc. Suspensión Electrónica Ajustable	
F	07	SIERRA 1500 WT Exc. Suspensión Electrónica Ajustable	
G51871	N		
R	97-04	CHEVROLET CORVETTE Todos Exc. Suspensión Electrónica Ajustable	
G51874	B		
R	07-15	NISSAN ALTIMA Todos	
G51875	D		
R	08-09	FORD TAURUS 4x2 Tracción delantera Izquierdo	
R	07	TAURUS 4x2 Tracción delantera Izquierdo Fab. hasta 06/07	
R	08-09	MERCURY SABLE 4x2 Tracción delantera Izquierdo	
G51876	D		
R	08-09	FORD TAURUS 4x2 Tracción delantera Derecho	
R	07	TAURUS 4x2 Tracción delantera Derecho Fab. hasta 06/07	
R	08-09	MERCURY SABLE 4x2 Tracción delantera Derecho	
G51877	C		
F	08-12	HONDA ACCORD Todos Izquierdo	
G51878	C		
F	08-12	HONDA ACCORD Todos Derecho	
G51879	B		
R	07-11	HONDA CR-V Todos	
G51880	D		
R	06-10	HONDA RIDGELINE Todos	
G51881	D		
R	02-06	MINI COOPER Todos	
G51882	D		
R	06-10	MITSUBISHI ECLIPSE Todos	
G51883	D		
R	10-11	MITSUBISHI GALANT SE	
R	04-11	GALANT ES	
R	04-08	GALANT DE	
R	05-07	GALANT SE	
G51884	D		
R	15-16	NISSAN MURANO Todos	
R	12-14	MURANO Exclusive	
R	11-14	MURANO SV	
R	09-14	MURANO LE	
R	08-14	MURANO S	
R	08-14	MURANO SL	
R	11-13	MURANO CrossCabriolet	
G51885	N		
R	99-06	SAAB 9-5 Todos	
G51886	N		
R	05-09	SUBARU LEGACY Todos	
G51887	D		
F	10-11	FORD CROWN VICTORIA Base	
F	07-11	CROWN VICTORIA LX	
F	03-08	CROWN VICTORIA Base	
F	04-06	CROWN VICTORIA LX Sport	
F	05	CROWN VICTORIA Special Edition	
F	03	CROWN VICTORIA LWB	
F	03	CROWN VICTORIA S	
F	03-11	LINCOLN TOWN CAR Todos Exc. Limo	
F	03-11	MERCURY GRAND MARQUIS Todos	
G51888	W		
F	03-11	FORD CROWN VICTORIA Police Interceptor	
F	03-11	LINCOLN TOWN CAR Todos Modelo Limo	
F	03-04	MERCURY MARAUDER Todos	
G51889	D		
R	05-07	FORD FREESTYLE 4x2 Tracción delantera Izquierdo	

Lista numérica

Amort.	POP	No. Alternativo	Montaje Accesorio
Pos.	Año	Aplicación	
G51889	D	-continued	
R	08-09	TAURUS X 4x2 Tracción delantera Izquierdo	
G51890	D		
R	05-07	FORD FREESTYLE 4x2 Tracción delantera Derecho	
R	08-09	TAURUS X 4x2 Tracción delantera Derecho	
G51891	B		
F	07-13	CADILLAC ESCALADE Todos Exc. Control de Manejo Electrónico	
F	07-13	ESCALADE ESV Todos Exc. Control de Manejo Electrónico	
F	07-13	ESCALADE EXT Todos Exc. Control de Manejo Electrónico	
F	11-13	CHEVROLET AVALANCHE 1500 Todos Exc. Suspensión Z55 o ZW7	
F	07-14	SUBURBAN 1/2 TON, 1500 Todos Exc. Suspensión Z55 o ZW7	
F	07-14	TAHOE Todos Exc. Suspensión Z55 o ZW7	
F	07-14	GMC YUKON Todos Exc. Suspensión Z55 o ZW7	
F	07-14	YUKON XL 1/2 TON Todos Exc. Suspensión Z55 o ZW7	
G51892	C		
R	08-12	HONDA ACCORD Todos	
G51894	B		
F	06-15	TOYOTA HILUX	
G51895	B		
R	09-14	VOLKSWAGEN GOL	
G51896	C		
F	10-12	FORD FUSION Todos Izquierdo	
F	10-12	LINCOLN MKZ Todos Izquierdo	
F	10-11	MERCURY MILAN Todos Izquierdo	
G51897	C		
F	10-12	FORD FUSION Todos Derecho	
F	10-12	LINCOLN MKZ Todos Derecho	
F	10-11	MERCURY MILAN Todos Derecho	
G51898	C		
R	09-10	PONTIAC VIBE 4x2 Tracción delantera	
R	09-16	TOYOTA COROLLA Todos	
R	09-11	MATRIX 4x2 Tracción delantera	
G51899	D		
F	01	HYUNDAI XG300 Todos	
F	02-05	XG350 Todos	
G51900	N		
R	04-08	BMW 525i Todos	
R	04-08	530i Todos	
G51901	D		
F	09-11	CADILLAC CTS Todos	
G51904	N		
F	97-04	CHEVROLET CORVETTE Todos Exc. Suspensión Electrónica Ajustable	
G51905	C		
R	10-12	HONDA CITY Todos	
R	13-14	FIT DX	
R	13-14	FIT EX	
R	13-14	FIT LX	
R	13-14	FIT Sport	
R	13	FIT Base	
R	09-12	FIT Todos Modelo Americano	
G51906	D		
F	06-08	MAZDA MX-5 Todos	
F	06-08	MX-5 MIATA Todos	
G51907	N		
R	06-08	MAZDA MX-5 Todos	
R	06-08	MX-5 MIATA Todos	
G51908	C		
R	08-10	MITSUBISHI LANCER DE	
R	08-10	LANCER ES	
G51909	D		
R	06-07	SUBARU B9 TRIBECA Todos	
R	08-13	TRIBECA Todos	
G51910	FF		
R	05-09	SUBARU OUTBACK Todos	

Lista numérica

Amort.	POP	No. Alternativo	Montaje Accesorio
Pos.	Año	Aplicación	
G51911	N		
F	05-11	ACURA RL Todos	
G51912	FF		
R	05-11	ACURA RL Todos Izquierdo	
G51913	FF		
R	05-11	ACURA RL Todos Derecho	
G51914	FF		
R	05-06	ACURA RSX Todos	
G51915	N		
F	06-08	AUDI A6 Todos Exc. Suspensión deportiva y neumática	
F	05-08	A6 QUATTRO Todos Exc. Suspensión deportiva y neumática	
G51916	FF		
R	14-15	CHEVROLET CAMARO Todos Exc. Electronic	
R	10-13	CAMARO 3.6L 6Cyl V (217)	
G51917	D		
F	09-14	ACURA TL Todos Izquierdo	
G51918	D		
F	09-14	ACURA TL Todos Derecho	
G51919	D		
R	09-14	ACURA TL Todos	
R	09-14	TSX Todos	
G51920	FF		
F	06-11	LEXUS IS250 Todos Izquierdo	
G51921	FF		
F	06-11	LEXUS IS250 Todos Derecho	
G51922	FF		
R	06-11	LEXUS IS250 Todos	
G51923	FF		
F	04-08	MAZDA RX8 Todos	
G51924	FF		
R	04-08	MAZDA RX8 Todos	
G51925	FF		
F	06-07	INFINITI M35 Todos Izquierdo	
F	06-07	M45 Todos Izquierdo	
G51926	FF		
F	06-07	INFINITI M35 Todos Derecho	
F	06-07	M45 Todos Derecho	
G51927	FF		
R	06-10	INFINITI M35 Todos	
R	06-10	M45 Todos	
G51928	D		
R	04-09	VOLKSWAGEN TOUAREG	
R	04-09	TOUAREG Todos	
G51930	FF		
R	97-01	INFINITI Q45 Todos	
G51933	FF		
R	10-11	MITSUBISHI ENDEAVOR AWD	
R	09	ENDEAVOR Todos AWD	
R	04-08	ENDEAVOR AWD	
G51934	D		
R	07-12	MINI COOPER Todos	
G51935	D		
F	06-09	PONTIAC SOLSTICE Todos	
G51936	D		
R	06-09	PONTIAC SOLSTICE Todos	
G51937	D		
F	08-11	TOYOTA SEQUOIA	
F	08-16	SEQUOIA Todos	
G51947	D		
F	05-10	CHRYSLER 300 4x2 Tracción trasera Izquierdo Performance Suspensión	
F	06-10	DODGE CHARGER 4x2 Tracción trasera Izquierdo Modelo Policía	
F	05-08	MAGNUM 4x2 Tracción trasera Izquierdo Performance Suspensión	
G51948	D		
F	05-10	CHRYSLER 300 4x2 Tracción trasera Derecho Performance Suspensión	

Asiento de Resorte Ultra

Amort.	POP	No. Alternativo	Montaje Accesorio
Pos.	Año	Aplicación	
G51948	D	-continued	
F	06-10	DODGE CHARGER 4x2 Tracción trasera Derecho Modelo Policía	
F	05-08	MAGNUM 4x2 Tracción trasera Derecho Performance Suspensión	
G51949	C		
F	14-15	CHEVROLET CHEYENNE	
F	14-15	PICKUP 1/2 TON, SILVERADO 1500 Todos	
F	14-15	GMC SIERRA 1500 Todos	
G51950	FF		
R	06-14	VOLKSWAGEN BORA	
R	11-13	JETTA	
G51953	FF		
F	06-09	NISSAN 350Z Todos Izquierdo	
G51954	FF		
F	06-09	NISSAN 350Z Todos Derecho	
G51955	FF		
R	06-09	NISSAN 350Z Todos	
G51960	FF		
F	15	CHEVROLET TAHOE Todos	
F	15	GMC YUKON Todos	
F	15	YUKON XL Todos	
G51961	FF		
R	09-12	SUBARU FORESTER Todos	
G51966	FF		
R	07-12	ACURA RDX Todos	
G51968	FF		
R	06-11	AUDI A6 Todos Exc. Suspensión deportiva y neumática	
R	05-11	A6 QUATTRO Todos Exc. Suspensión deportiva y neumática	
G51969	FF		
R	04-06	MITSUBISHI GALANT LS	
G51970	FF		
F	05-10	CHRYSLER 300 AWD	
F	07-10	DODGE CHARGER AWD	
F	05-08	MAGNUM AWD	
G51971	C		
R	11-15	CHEVROLET CRUZE Todos	
R	16	CRUZE LIMITED Todos	
G51972	FF		
R	13-14	HONDA CR-V Todos	
G51975	FF		
R	10-12	CHEVROLET CAMARO SS	
G51976	FF		
R	09-13	NISSAN CUBE Todos	
G51977	N		
R	08-10	MITSUBISHI LANCER	
G51979	N		
F	05-06	INFINITI G35 AWD Izquierdo	
G51980	N		
R	11-16	FORD EXPLORER Todos	
G51981	N		
F	05-06	INFINITI G35 AWD Derecho	
G51982	FF		
R	11-12	BUICK REGAL Todos Exc. Suspensión Activa	
G51983	FF		
R	10-13	MAZDA 3 Todos	
G51984	FF		
F	09-13	MAZDA 6 Todos Izquierdo	
G51985	FF		
F	09-13	MAZDA 6 Todos Derecho	
G51989	FF		
R	11-14	NISSAN JUKE	
G51990	B		
R	14-16	NISSAN NOTE Todos	
R	13-16	VERSA Todos	
G51993	D		
R	13-15	AUDI Q3 Todos	
R	09-11	VOLKSWAGEN TIGUAN Todos	

Lista numérica

Amort.	POP	No. Alternativo	Montaje Accesorio
Pos.	Año	Aplicación	
G51994	N		
R	07-09	KIA AMANTI Todos	
G51995	FF		
R	02-05	LEXUS SC430 Todos	
G51996	N		
R	09-16	FORD FLEX Todos	
R	10-16	LINCOLN MKT Todos	
G51997	N		
R	04-06	SUZUKI VERONA Todos Izquierdo	
G51998	N		
R	04-06	SUZUKI VERONA Todos Derecho	
G511000	FF		
R	11-15	JEEP GRAND CHEROKEE Todos	
G511001	FF		
R	12-16	FORD ESCAPE Todos	
G511002	FF		
R	12-14	FORD FOCUS Todos	
G511003	N		
R	13-14	HONDA ACCORD	
G511004	FF		
R	10-11	MITSUBISHI OUTLANDER GT w/ 3rd Row Seating	
R	09-11	OUTLANDER SE w/ 3rd Row Seating	
R	09-11	OUTLANDER XLS w/ 3rd Row Seating	
R	08	OUTLANDER XLS	
R	07	OUTLANDER Todos	
G511019	FF		
F	07-08	INFINITI G35 AWD Izquierdo Exc. 4 Wheel Steer	
F	09-10	G37 AWD Izquierdo Exc. 4 Wheel Steer	
G511020	FF		
F	07-08	INFINITI G35 AWD Derecho Exc. 4 Wheel Steer	
F	09-10	G37 AWD Derecho Exc. 4 Wheel Steer	
G511021	FF		
R	07-08	INFINITI G35 AWD Exc. 4 Wheel Steer	
R	09-10	G37 AWD Exc. 4 Wheel Steer	
G511030	N		
R	13-14	CHEVROLET TRAX Todos	
G511031	FF		
F	11-16	CHRYSLER 300 4x2 Tracción trasera Izquierdo Includes Police	
F	11-16	DODGE CHARGER 4x2 Tracción trasera Izquierdo Includes Police	
G511032	FF		
F	11-16	CHRYSLER 300 4x2 Tracción trasera Derecho Includes Police	
F	11-16	DODGE CHARGER 4x2 Tracción trasera Derecho Includes Police	
G511037	FF		
R	11-14	HONDA CR-Z Todos	
G511040	FF		
R	12-13	MAZDA 5 Todos	
G511041	FF		
R	12-13	MERCEDES-BENZ E200 Todos	
R	11-13	E250 Todos	
R	11-13	E300 Todos	
R	11-13	E350 Todos	
R	13	E400 Todos	
R	11-13	E500 Todos	
R	11-13	E550 Todos	
G511042	FF		
R	11-12	NISSAN LEAF Todos	
G511043	FF		
R	13-16	NISSAN PATHFINDER Todos	
G511044	FF		
R	13-15	NISSAN SENTRA	
G511054	FF		
F	07-09	KIA SORENTO Todos Izquierdo Exc. HPD (High Performance Dampers)	

Lista numérica

Lista numérica

Amort.	POP	No. Alternativo	Montaje Accesorio
Pos.	Año	Aplicación	
G511055	FF		
F	07-09	KIA SORENTO Todos Derecho Exc. HPD (High Performance Dampers)	
G511057	FF		
F	03-04	AUDI A6 Confort Exc. Suspensión Deportiva	
F	02-04	A6 Luxury Exc. Suspensión Deportiva	
F	98-04	A6 Base Exc. Suspensión Deportiva	
F	02	A6 Premium Exc. Suspensión Deportiva	
F	98-04	A6 QUATTRO Todos	
G511061	FF		
R	07-11	SUZUKI SWIFT Todos	
R	12-15	SWIFT+	
G511062	FF		
R	06-08	HONDA FIT	
G511063	FF		
F	08-10	MINIBUSHI MONTERO Todos Sport	
F	08-12	MONTERO SPORT	
G511064	FF		
R	08-12	MINIBUSHI MONTERO SPORT	
G511065	FF		
R	05-11	MINIBUSHI MONTERO	
G511066	FF		
R	08-11	MINIBUSHI MONTERO Todos	
R	07-11	MONTERO	
R	05-06	MONTERO Todos	
R	05	MONTERO	
G511070	FF		
R	02-05	BMW 745i Todos	
R	02-05	745Li Todos	
R	06-08	750i Todos	
R	06-08	750Li Todos	
R	04-06	760i Todos	
R	03-08	760Li Todos	
G511071	N		
F	07-09	KIA AMANTI Todos	
G511072	N		
R	09-12	AUDI A4	
R	09-12	A4 QUATTRO	
G511074	FF		
R	10	BUICK ALLURE AWD Exc. Suspensión Electrónica Ajustable	
R	10-12	LACROSSE AWD Exc. Suspensión Electrónica Ajustable	
G511076	FF		
R	09-12	AUDI A4 Todos Sport Suspensión	
R	09-12	A4 Todos Suspensión Deportiva	
R	09-12	A4 QUATTRO Todos Sport Suspensión	
R	09-12	A4 QUATTRO Todos Suspensión Deportiva	
G511081	FF		
R	12-14	VOLKSWAGEN BORA	
R	12-14	PASSAT	
R	12-14	RABBIT	
G511102	FF		
F	10-15	FORD F-150	
F	10-15	LOBO PICK UP	
G511103	FF		
F	10-15	FORD F-150	
F	10-15	LOBO PICK UP	
G511119	FF		
R	13-16	NISSAN LEAF Todos	
G511122	FF		
R	14-16	NISSAN JUKE	
G511123	FF		
R	14-16	NISSAN JUKE	
G511124	FF		
F	12-16	NISSAN NV1500	
G511130	FF		
F	16	NISSAN TITAN	
G511140	W		
F	08-15	MINIBUSHI L200 Todos	

Amort.	POP	No. Alternativo	Montaje Accesorio
Pos.	Año	Aplicación	
G511141	W		
R	08-15	MINIBUSHI L200 Todos	
Struts Hidráulicos			
51006	C		
R	77-87	VOLKSWAGEN ATLANTIC	
R	77-87	CARIBE	
51017	FF		
R	84-88	VOLKSWAGEN CORSAR	
51022	A		
R	87-99	VOLKSWAGEN GOLF	
R	87-98	GTI	
R	87-98	JETTA	
51091	D		
R	94-99	VOLKSWAGEN DERBY	
55514	D		
F	90	CHEVROLET CELEBRITY	
F	82	CELEBRITY 2.8L 6Cyl V (173)	
F	89-96	CENTURY	
F	83-86	CENTURY	
F	86-88	CITATION	
F	86-97	CUTLASS	
F	91-96	EUROSPORT	
55526	C		
F	86-89	CHRYSLER DART	
F	86-95	LEBARON	
F	86-89	LEBARON K	
F	86-89	MAGNUM K	
F	89-93	NEW YORKER	
F	86-88	NEW YORKER 2.2L 4Cyl L (135)	
F	86-94	PHANTOM	
F	88-94	SHADOW	
F	89-95	SPIRIT RT	
F	86-89	VOLARE	
F	86-89	DODGE DART K	
F	86-88	MAGNUM K	
F	92-94	SHADOW	
F	88-90	SHADOW	
F	93-95	SPIRIT RT	
F	89-90	SPIRIT RT	
F	86-88	PLYMOUTH VOLARE K	
55657	A		
F	92-05	NISSAN TSUBAME	
F	92-18	TSURU	
55658	A		
F	92-05	NISSAN TSUBAME	
F	92-18	TSURU	
55745	B		
F	88-91	NISSAN HIKARI	
F	91-93	NX	
F	86-90	PULSAR NX	
F	87-92	SENTRA	
F	88-91	TSURU	
55746	B		
R	88-91	NISSAN HIKARI	
R	86-90	PULSAR NX	
R	87-92	SENTRA	
R	88-91	TSURU	
55976	A		
R	92-18	NISSAN TSURU	
55977	A		
R	92-18	NISSAN TSURU	
55991	A		
F	01-02	SEAT CORDOBA	
F	94-07	VOLKSWAGEN DERBY	
F	87-99	GOLF	
F	87-98	GTI	
F	87-98	JETTA	
56743	D		
F	04-06	PEUGEOT 306	
F	97-02	306	
56744	D		
F	97-06	PEUGEOT 306	
56980	A		
F	12	DODGE ATOS	
Struts Ultra			
G35066	A		
F	01-02	SEAT CORDOBA	
F	94-07	VOLKSWAGEN DERBY	
F	87-99	GOLF	

Amort.	POP	No. Alternativo	Montaje Accesorio
Pos.	Año	Aplicación	
G35066	A	-continued	
F	87-98	GTI	
F	87-98	JETTA	
G52000	C		
F	00-01	NISSAN X-TRAIL	
F	02-07	X-TRAIL Todos Izquierdo	
G52001	C		
F	00-01	NISSAN X-TRAIL	
F	02-07	X-TRAIL Todos Derecho	
G52002	C		
R	00-01	NISSAN X-TRAIL	
R	02-07	X-TRAIL Todos Izquierdo	
G52003	C		
R	00-01	NISSAN X-TRAIL	
R	02-07	X-TRAIL Todos Derecho	
G52004	C		
F	06-12	TOYOTA RAV4 Todos Izquierdo	
G52005	B		
F	12-13	MAZDA 3 GS-SKY Izquierdo	
F	08-13	3 GT Izquierdo	
F	08-13	3 GX Izquierdo	
F	07-13	3 Izquierdo	
F	07-13	3 S Izquierdo	
F	13	3 Grand Touring Izquierdo	
F	13	3 Touring Izquierdo	
F	08-12	3 GS Izquierdo	
F	11	3 Sport GS Izquierdo	
F	11	3 Sport GT Izquierdo	
F	11	3 Sport GX Izquierdo	
F	04-06	3 Todos Izquierdo	
F	06-10	5 Todos Izquierdo	
G52006	B		
F	12-13	MAZDA 3 GS-SKY Derecho	
F	08-13	3 GT Derecho	
F	08-13	3 GX Derecho	
F	07-13	3 Derecho	
F	07-13	3 S Derecho	
F	13	3 Grand Touring Derecho	
F	13	3 Touring Derecho	
F	08-12	3 GS Derecho	
F	11	3 Sport GS Derecho	
F	11	3 Sport GT Derecho	
F	11	3 Sport GX Derecho	
F	04-06	3 Todos Derecho	
F	06-10	5 Todos Derecho	
G52007	C		
F	06-12	TOYOTA RAV4 Todos Derecho	
G52008	D	141682	
F	03-07	NISSAN MURANO Todos Izquierdo	
G52009	D	141682	
F	03-07	NISSAN MURANO Todos Derecho	
G52011	C		
F	04-08	RENAULT MEGANE II	
G52013	D		
F	03-08	PONTIAC VIBE Todos Izquierdo	
F	03-08	TOYOTA MATRIX Todos Izquierdo	
G52014	D		
F	03-08	PONTIAC VIBE Todos Derecho	
F	03-08	TOYOTA MATRIX Todos Derecho	
G52015	D		
F	04-05	KIA RIO Todos Izquierdo	
G52016	D		
F	04-05	KIA RIO Todos Derecho	
G52017	N		
R	02-03	KIA SPECTRA Todos Izquierdo	
G52018	N		
R	02-03	KIA SPECTRA Todos Derecho	
G52019	W		
F	02-03	SUZUKI AERIO Todos Izquierdo	
G52020	W		
F	02-03	SUZUKI AERIO Todos Derecho	
G52021	D		
R	02-07	SUZUKI AERIO Todos Izquierdo	
G52022	D		
R	02-07	SUZUKI AERIO Todos Derecho	

Lista numérica

Amort.	POP	No. Alternativo	Montaje Accesorio
Pos.	Año	Aplicación	
G52023	D		
F	05-09	SUBARU LEGACY Todos Izquierdo	
G52024	D		
F	05-09	SUBARU LEGACY Todos Derecho	
G52025	C		
F	05-07	BUICK TERRAZA Todos Exc. Suspensión con Nivelación Neumática	
F	05-09	CHEVROLET UPLANDER Todos Exc. Suspensión con Nivelación Neumática	
F	05-09	PONTIAC MONTANA SV6 Exc. Suspensión Autonivelable	
F	05-07	SATURN RELAY Todos Exc. Suspensión con Nivelación Neumática	
G52026	C		
F	02-07	SATURN VUE Todos Izquierdo	
G52027	C		
F	02-07	SATURN VUE Todos Derecho	
G52028	B		
F	04-12	CHEVROLET MALIBU Todos Izquierdo	
F	05-10	PONTIAC G6 Todos Izquierdo	
F	07-09	SATURN AURA Todos Izquierdo	
G52029	B		
F	04-12	CHEVROLET MALIBU Todos Derecho	
F	05-10	PONTIAC G6 Todos Derecho	
F	07-09	SATURN AURA Todos Derecho	
G52030	C		
F	05-07	HONDA ODYSSEY Todos Izquierdo	
G52031	C		
F	05-07	HONDA ODYSSEY Todos Derecho	
G52032	D		
F	04-09	NISSAN QUEST Todos Izquierdo	
G52033	D		
F	04-09	NISSAN QUEST Todos Derecho	
G52034	N		
F	02-05	KIA SEDONA Todos Izquierdo	
G52035	N		
F	02-05	KIA SEDONA Todos Derecho	
G52036	N		
F	03-06	KIA SORENTO Todos Izquierdo	
G52037	N		
F	03-06	KIA SORENTO Todos Derecho	
G52038	C		
F	10-11	HONDA CIVIC EX-L Izquierdo	
F	10-11	CIVIC Hybrid-L Izquierdo	
F	10-11	CIVIC LX-S Izquierdo	
F	08-11	CIVIC DX-G Izquierdo	
F	06-11	CIVIC DX Izquierdo	
F	06-11	CIVIC EX Izquierdo	
F	06-11	CIVIC Hybrid Izquierdo	
F	06-11	CIVIC LX Izquierdo	
F	11	CIVIC Base Izquierdo	
F	09-10	CIVIC Sport Izquierdo	
F	08	CIVIC EX-L Izquierdo	
F	06-07	CIVIC EXS Izquierdo	
F	06-07	CIVIC LXS Izquierdo	
G52039	C		
F	10-11	HONDA CIVIC EX-L Derecho	
F	10-11	CIVIC Hybrid-L Derecho	
F	10-11	CIVIC LX-S Derecho	
F	08-11	CIVIC DX-G Derecho	
F	06-11	CIVIC DX Derecho	
F	06-11	CIVIC EX Derecho	
F	06-11	CIVIC Hybrid Derecho	
F	06-11	CIVIC LX Derecho	
F	11	CIVIC Base Derecho	
F	09-10	CIVIC Sport Derecho	
F	08	CIVIC EX-L Derecho	
F	06-07	CIVIC EXS Derecho	
F	06-07	CIVIC LXS Derecho	
G52040	B		
F	03-14	RENAULT KANGOO	
G52041	A		
F	06	FORD ECOSPORT	
F	04	ECOSPORT	
F	07-08	ECOSPORT	

Struts Ultra

Amort.	POP	No. Alternativo	Montaje Accesorio
Pos.	Año	Aplicación	
G52041	A	-continued	
F	05	ECOSPORT	
G52042	A		
F	03-10	FORD FIESTA	
G52043	C		
F	03-08	FIAT PALIO	
G52044	D		
F	03-08	CHEVROLET VECTRA	
G52045	D		
F	03-08	CHEVROLET VECTRA	
G52046	C		
F	03-12	PEUGEOT GRAND RAID	
F	03-09	PARTNER Todos Izquierdo	
G52047	C		
F	03-12	PEUGEOT GRAND RAID	
F	03-09	PARTNER Todos Derecho	
G52048	B		
F	03-08	SEAT CORDOBA	
F	03-09	IBIZA	
F	05-09	VOLKSWAGEN LUPO	
F	03-07	POLO	
G52052	D		
F	00-05	CHEVROLET MATIZ	
F	00-05	PONTIAC G1	
F	00-05	G2	
G52053	D		
F	00-05	CHEVROLET MATIZ	
F	00-05	PONTIAC G1	
F	00-05	G2	
G52055	C		
F	02-06	NISSAN SENTRA SE-R Izquierdo	
F	02-06	SENTRA SE-R Spec V Izquierdo	
F	10	RENAULT SCALA	
F	11-13	SCALA Todos Izquierdo	
G52056	C		
F	02-06	NISSAN SENTRA SE-R Derecho	
F	02-06	SENTRA SE-R Spec V Derecho	
F	10	RENAULT SCALA	
F	11-13	SCALA Todos Derecho	
G52057	N		141716
F	96-04	ACURA RL Todos Izquierdo	
G52058	D		141716
F	96-04	ACURA RL Todos Derecho	
G52061	N		141682
F	03-08	INFINITI FX35 Todos Izquierdo	
F	03-08	FX45 Todos Izquierdo	
G52062	N		141682
F	03-08	INFINITI FX35 Todos Derecho	
F	03-08	FX45 Todos Derecho	
G52063	X		141309
F	00-01	KIA SPECTRA Todos Izquierdo	
G52064	X		
F	00-01	KIA SPECTRA Todos Derecho	
G52065	C		
F	03-06	MITSUBISHI OUTLANDER Todos	
G52066	N		141309
F	02-06	SAAB 9-5 Todos	
G52067	FF		141309
F	04-05	SUBARU FORESTER Todos Izquierdo	
G52068	FF		141309
F	04-05	SUBARU FORESTER Todos Derecho	
G52069	D		141309
F	03	SUBARU FORESTER Todos Izquierdo	
G52070	N		141309
F	03	SUBARU FORESTER Todos Derecho	
G52071	X		
R	02-03	SUBARU IMPREZA TS , Wagon Izquierdo	

Lista numérica

Amort.	POP	No. Alternativo	Montaje Accesorio
Pos.	Año	Aplicación	
G52073	N		141309
R	02-03	SUBARU IMPREZA RS , Sedan Izquierdo	
R	02-03	IMPREZA TS Izquierdo	
G52074	N		141309
R	02-03	SUBARU IMPREZA RS , Sedan Derecho	
R	02-03	IMPREZA TS Derecho	
G52075	D		141682
F	04-07	SUZUKI AERIO Todos Izquierdo	
G52076	D		141682
F	04-07	SUZUKI AERIO Todos Derecho	
G52077	N		141309
F	01-03	TOYOTA PRIUS Todos Izquierdo	
G52078	N		141309
F	01-03	TOYOTA PRIUS Todos Derecho	
G52079	D		141682
F	01-04	VOLVO S40 Todos Izquierdo	
F	00	S40 Todos Izquierdo Fab. desde 4/00	
F	04	V40 Todos Izquierdo Fab. desde 4/00	
F	01-03	V40 Todos Izquierdo	
F	00	V40 Todos Izquierdo Fab. desde 4/00	
G52080	D		141682
F	01-04	VOLVO S40 Todos Derecho	
F	00	S40 Todos Derecho Fab. desde 4/00	
F	04	V40 Todos Derecho Fab. desde 4/00	
F	01-03	V40 Todos Derecho	
F	00	V40 Todos Derecho Fab. desde 4/00	
G52081	B		141682
F	07-12	DODGE CALIBER Todos Izquierdo	
F	07-10	JEEP COMPASS Todos Izquierdo	
F	07-10	PATRIOT Todos Izquierdo	
G52082	B		141682
F	07-12	DODGE CALIBER Todos Derecho	
F	07-10	JEEP COMPASS Todos Derecho	
F	07-10	PATRIOT Todos Derecho	
G52083	N		141309
F	04-07	SUBARU IMPREZA Wagon Izquierdo	
G52084	N		141309
F	04-07	SUBARU IMPREZA Wagon Derecho	
G52085	N		141309
R	04-07	SUBARU IMPREZA Wagon, AWD Izquierdo	
G52086	N		141309
R	04-07	SUBARU IMPREZA Wagon, AWD Derecho	
G52087	N		141309
F	04-07	SUBARU IMPREZA Sedan Izquierdo	
G52088	N		141309
F	04-07	SUBARU IMPREZA Sedan Derecho	
G52089	N		141309
R	04	SUBARU IMPREZA Sedan, AWD Izquierdo	
G52090	N		141309
R	04	SUBARU IMPREZA Sedan, AWD Derecho	
G52094	A		
F	07-12	NISSAN SENTRA Base Izquierdo	
F	07-12	SENTRA S Izquierdo	
F	07-12	SENTRA SL Izquierdo	
G52095	A		
F	07-12	NISSAN SENTRA Base Derecho	
F	07-12	SENTRA S Derecho	
F	07-12	SENTRA SL Derecho	
G52096	N		
F	05-10	SCION TC Todos Izquierdo	
G52097	N		
F	05-10	SCION TC Todos Derecho	
G52098	N		
F	04-06	SCION XA Todos	

Lista numérica

Amort.	POP	No. Alternativo	Montaje Accesorio
Pos.	Año	Aplicación	
G52098	N	-continued	
F	04-06	XB Todos	
G52103	C		
R	07-12	LEXUS ES350 Todos Izquierdo	
R	06-11	TOYOTA AVALON Todos Izquierdo Fab. desde 1/06	
R	07-11	CAMRY Todos Izquierdo	
G52104	C		
R	07-12	LEXUS ES350 Todos Derecho	
R	06-11	TOYOTA AVALON Todos Derecho Fab. desde 1/06	
R	07-11	CAMRY Todos Derecho	
G52105	D		
F	06-10	TOYOTA SIENNA AWD Izquierdo	
F	06-10	SIENNA 4x2 Tracción delantera Izquierdo 8 Pasajeros	
F	05	SIENNA AWD Izquierdo Fab. desde 7/05	
F	05	SIENNA 4x2 Tracción delantera Izquierdo Fab. desde 7/05, 8 Pasajeros	
G52106	D		
F	06-10	TOYOTA SIENNA AWD Derecho	
F	06-10	SIENNA 4x2 Tracción delantera Derecho 8 Pasajeros	
F	05	SIENNA AWD Derecho Fab. desde 7/05	
F	05	SIENNA 4x2 Tracción delantera Derecho Fab. desde 7/05, 8 Pasajeros	
G52107	D		
F	05-10	TOYOTA SIENNA 4x2 Tracción delantera Izquierdo Fab. desde 7/05, 7 Pasajeros	
G52108	D		
F	05-10	TOYOTA SIENNA 4x2 Tracción delantera Derecho Fab. desde 7/05, 7 Pasajeros	
G52110	D		
F	05-07	FORD FREESTYLE Todos Izquierdo	
G52111	D		
F	05-07	FORD FREESTYLE Todos Derecho	
G52112	C		
F	04-06	HONDA ELEMENT LX Izquierdo	
F	03-06	ELEMENT EX Izquierdo	
F	03-04	ELEMENT DX Izquierdo	
G52113	C		
F	05-06	HONDA ELEMENT EX Derecho	
F	04-06	ELEMENT LX Derecho	
F	03-04	ELEMENT DX Derecho	
G52116	D		
F	06-11	BUICK LUCERNE Todos Exc. Suspensión Magnética de Control de Manejo	
F	06-11	CADILLAC DTS Todos Exc. Suspensión Magnética de Control de Manejo	
G52117	B		
F	11-14	CHRYSLER 200 Todos Izquierdo Suspensión Estándar	
F	08-10	SEBRING Todos Izquierdo	
F	08-14	DODGE AVENGER Todos Izquierdo	
G52118	B		
F	11-14	CHRYSLER 200 Todos Derecho Suspensión Estándar	
F	08-10	SEBRING Todos Derecho	
F	08-14	DODGE AVENGER Todos Derecho	
G52121	B		
F	07-13	NISSAN ALTIMA Base Izquierdo	
F	07-13	ALTIMA S Izquierdo	
F	07-13	ALTIMA SL Izquierdo	
F	13	ALTIMA Advance Izquierdo	
F	13	ALTIMA Exclusive Izquierdo	
F	13	ALTIMA Sense Izquierdo	
F	13	ALTIMA SV Izquierdo	
F	10-12	ALTIMA SR Izquierdo	
F	08-09	ALTIMA Coupe Izquierdo	
F	07-09	ALTIMA SE Izquierdo	
G52122	B		
F	07-13	NISSAN ALTIMA Base Derecho	
F	07-13	ALTIMA S Derecho	
F	07-13	ALTIMA SL Derecho	

Struts Ultra

Amort.	POP	No. Alternativo	Montaje Accesorio
Pos.	Año	Aplicación	
G52122	B	-continued	
F	13	ALTIMA Advance Derecho	
F	13	ALTIMA Exclusive Derecho	
F	13	ALTIMA Sense Derecho	
F	13	ALTIMA SV Derecho	
F	10-12	ALTIMA SR Derecho	
F	08-09	ALTIMA Coupe Derecho	
F	07-09	ALTIMA SE Derecho	
G52123	N		
F	04-06	PONTIAC GTO Todos Izquierdo	
G52124	N		
F	04-06	PONTIAC GTO Todos Derecho	
G52125	A		
F	08-12	BUICK ENCLAVE Todos	
F	09-12	CHEVROLET TRAVEVERSE Todos	
F	07-12	GMC ACADIA Todos	
F	07-10	SATURN OUTLOOK Todos	
G52127	B		
F	07	CHEVROLET CAPTIVA SPORT	
F	08-12	CAPTIVA SPORT Todos Izquierdo	
F	07-12	EQUINOX Todos Izquierdo Exc. Suspensión Deportiva	
F	10-12	GMC TERRAIN Todos Izquierdo	
F	07-09	PONTIAC TORRENT Todos Izquierdo Exc. Suspensión Deportiva	
F	08-10	SATURN VUE Todos Izquierdo	
F	07-09	SUZUKI XL-7 Todos Izquierdo	
G52128	B		
F	07	CHEVROLET CAPTIVA SPORT	
F	08-12	CAPTIVA SPORT Todos Derecho	
F	07-12	EQUINOX Todos Derecho Exc. Suspensión Deportiva	
F	10-12	GMC TERRAIN Todos Derecho	
F	07-09	PONTIAC TORRENT Todos Derecho Exc. Suspensión Deportiva	
F	08-10	SATURN VUE Todos Derecho	
F	07-09	SUZUKI XL-7 Todos Derecho	
G52129	D		
F	08-09	FORD TAURUS 4x2 Tracción delantera Izquierdo	
F	08-09	MERCURY SABLE 4x2 Tracción delantera Izquierdo	
G52130	D		
F	08-09	FORD TAURUS 4x2 Tracción delantera Derecho	
F	08-09	MERCURY SABLE 4x2 Tracción delantera Derecho	
G52131	B		
F	15-16	CHRYSLER TOWN & COUNTRY Touring Piel	
F	13-16	TOWN & COUNTRY Li	
F	13-16	TOWN & COUNTRY Limited	
F	13-16	TOWN & COUNTRY LX	
F	13-16	TOWN & COUNTRY Touring	
F	13-16	TOWN & COUNTRY Touring L	
F	16	TOWN & COUNTRY Limited Platinum	
F	16	TOWN & COUNTRY Premium	
F	14	TOWN & COUNTRY 30th Anniversary Edition	
F	14	TOWN & COUNTRY Base	
F	08-12	TOWN & COUNTRY Todos Exc. Suspensión Autonivelable	
F	14-16	DODGE CARAVAN / GRAND CARAVAN American Value Package	
F	13-16	CARAVAN / GRAND CARAVAN SE	
F	13-14	CARAVAN / GRAND CARAVAN Crew	
F	13-14	CARAVAN / GRAND CARAVAN Crew Plus	
F	14	CARAVAN / GRAND CARAVAN 30th Anniversary Edition	
F	14	CARAVAN / GRAND CARAVAN SE 30th Anniversary Edition	
F	14	CARAVAN / GRAND CARAVAN SE Canada Value Package	
F	14	CARAVAN / GRAND CARAVAN SXT Plus	
F	13	CARAVAN / GRAND CARAVAN Canada Value Package	
F	08-12	CARAVAN / GRAND CARAVAN Todos Exc. Suspensión Autonivelable	
F	09-11	VOLKSWAGEN ROUTAN Todos Exc. Suspensión Autonivelable	

Lista numérica

Amort.	POP	No. Alternativo	Montaje Accesorio
Pos.	Año	Aplicación	
G52136	D		
F	05-07	FORD FIVE HUNDRED AWD Izquierdo	
G52137	D		
F	05-07	FORD FIVE HUNDRED AWD Derecho	
G52138	D		
F	05-07	FORD FIVE HUNDRED 4x2 Tracción delantera Izquierdo	
F	05-07	MERCURY MONTEGO 4x2 Tracción delantera Izquierdo	
G52139	D		
F	05-07	FORD FIVE HUNDRED 4x2 Tracción delantera Derecho	
F	05-07	MERCURY MONTEGO 4x2 Tracción delantera Derecho	
G52140	D		
F	03-06	ACURA MDX Todos Izquierdo	
G52141	D		
F	03-06	ACURA MDX Todos Derecho	
G52142	C		
F	08-11	BMW 128I Todos Izquierdo	
F	05-13	135I	
F	06-14	325I	
F	07-13	328I Todos Izquierdo	
F	07-11	330I	
F	07-13	335I Todos Izquierdo	
G52143	C		
F	08-11	BMW 128I Todos Derecho	
F	05-13	135I	
F	07-14	325I	
F	07-13	328I Todos Derecho	
F	07-11	330I	
F	11-13	335I Todos Derecho	
G52144	D		
F	00-06	BMW X5 Coil (FrontSpringType) Izquierdo	
G52145	D		
F	00-06	BMW X5 Coil (FrontSpringType) Derecho	
G52148	B		
F	09-15	DODGE JOURNEY Todos Izquierdo	
G52149	B		
F	09-15	DODGE JOURNEY Todos Derecho	
G52150	D		
F	06-11	HONDA RIDGELINE Todos Izquierdo	
G52151	D		
F	06-11	HONDA RIDGELINE Todos Derecho	
G52152	C		
F	10-12	HONDA CITY Todos Izquierdo	
F	15-16	FIT Todos Izquierdo	
F	13-14	FIT DX Izquierdo	
F	13-14	FIT EX Izquierdo	
F	13-14	FIT LX Izquierdo	
F	13-14	FIT Sport Izquierdo	
F	13	FIT Base Izquierdo	
F	09-12	FIT Todos Izquierdo Modelo Americano	
G52153	C		
F	10-12	HONDA CITY Todos Derecho	
F	15-16	FIT Todos Derecho	
F	13-14	FIT DX Derecho	
F	13-14	FIT EX Derecho	
F	13-14	FIT LX Derecho	
F	13-14	FIT Sport Derecho	
F	13	FIT Base Derecho	
F	09-12	FIT Todos Derecho Modelo Americano	
G52154	B		
F	06-11	DODGE ATTITUDE Todos Izquierdo	
F	06-11	HYUNDAI ACCENT Todos Izquierdo	
F	06-11	KIA RIO Todos Izquierdo	
F	06-11	RIO Todos Izquierdo	
G52155	B		
F	06-11	DODGE ATTITUDE Todos Derecho	
F	06-11	HYUNDAI ACCENT Todos Derecho	
F	06-11	KIA RIO Todos Derecho	
F	06-11	RIO Todos Derecho	

Lista numérica

Amort.	POP	No. Alternativo	Montaje Accesorio
Pos.	Año	Aplicación	
G52156	N		
F	07-10	HYUNDAI	ELANTRA Todos Izquierdo
G52157	N		
F	07-10	HYUNDAI	ELANTRA Todos Derecho
G52158	D		
F	07-09	HYUNDAI	SANTA FE Todos Izquierdo
G52159	D		
F	07-09	HYUNDAI	SANTA FE Todos Derecho
G52160	D		
F	05-09	KIA	SPECTRA Todos Izquierdo
F	04-09	SPECTRA	Todos Izquierdo
G52161	D		
F	05-09	KIA	SPECTRA Todos Derecho
F	04-09	SPECTRA	Todos Derecho
G52162	D		
R	07-09	KIA	SPECTRA Todos Izquierdo
R	04-09	SPECTRA	Todos Izquierdo
G52163	D		
R	07-09	KIA	SPECTRA Todos Derecho
R	04-09	SPECTRA	Todos Derecho
G52164	D		
F	02-06	MINI	COOPER Todos Izquierdo
G52165	D		
F	02-06	MINI	COOPER Todos Derecho
G52166	D		
F	06-12	MINI	COOPER Todos Derecho
G52167	D		
F	06-12	MITSUBISHI	ECLIPSE Todos Izquierdo
G52168	D		
F	10-11	MITSUBISHI	GALANT SE Izquierdo
F	04-11	GALANT ES	Izquierdo
F	04-08	GALANT LE	Izquierdo
F	05-07	GALANT SE	Izquierdo
G52169	D		
F	10-11	MITSUBISHI	GALANT SE Derecho
F	04-11	GALANT ES	Derecho
F	04-08	GALANT LE	Derecho
F	05-07	GALANT SE	Derecho
G52170	D		
F	12-13	NISSAN	MURANO Exclusive Izquierdo
F	11-13	MURANO	CrossCabriolet Izquierdo
F	11-13	MURANO SV	Izquierdo
F	09-13	MURANO LE	Izquierdo
F	09-13	MURANO S	Izquierdo
F	13	MURANO SL	Izquierdo
F	12	MURANO SL	Izquierdo Fab. hasta 12/12
F	08-11	MURANO SL	Izquierdo
G52171	D		
F	12-13	NISSAN	MURANO Exclusive Derecho
F	11-13	MURANO	CrossCabriolet Derecho
F	11-13	MURANO SV	Derecho
F	09-13	MURANO LE	Derecho
F	08-13	MURANO S	Derecho
F	08-13	MURANO SL	Derecho
G52172	D		
F	12	MERCEDES-BENZ	C250 Sedan, CGI (FuelDelSubType)
F	10-11	C250	Todos
F	08-09	C280	Todos
F	11	C300	Todos
F	10	C300	Todos Exc. 4-Matic Models
F	08-09	C300	Todos
F	12	C350 CGI	(FuelDelSubType)
F	08-11	C350	Todos
G52173	C		
F	08-12	NISSAN	ROGUE Todos Izquierdo With EO# E4303JM00A
F	10-12	X-TRAIL	Todos Izquierdo
F	08	X-TRAIL	Todos Izquierdo
F	09-14	RENAULT	KOLEOS Todos Izquierdo

Struts Ultra

Amort.	POP	No. Alternativo	Montaje Accesorio
Pos.	Año	Aplicación	
G52174	C		
F	08-12	NISSAN	ROGUE Todos Derecho With EO# E4302JM00A
F	10-12	X-TRAIL	Todos Derecho
F	08	X-TRAIL	Todos Derecho
F	09-14	RENAULT	KOLEOS Todos Derecho
G52175	FF		
F	03-08	SAAB	9-3 Todos Izquierdo
G52176	FF		
F	03-08	SAAB	9-3 Todos Derecho
G52178	N		
R	03-05	SUBARU	FORESTER Todos Izquierdo
G52179	N		
R	03-05	SUBARU	FORESTER Todos Derecho
G52180	D		
F	06-08	SUBARU	FORESTER Todos Izquierdo
G52181	D		
F	06-08	SUBARU	FORESTER Todos Derecho
G52182	D		
R	06-08	SUBARU	FORESTER Todos Izquierdo
G52183	D		
R	06-08	SUBARU	FORESTER Todos Derecho
G52184	D		
F	06-12	SUZUKI	GRAND VITARA Todos Izquierdo
G52185	D		
F	06-12	SUZUKI	GRAND VITARA Todos Derecho
G52187	C		
F	07-12	ACURA	RDX Todos Izquierdo
F	07-14	HONDA	CR-V Todos Izquierdo
G52188	C		
F	07-12	ACURA	RDX Todos Derecho
F	07-14	HONDA	CR-V Todos Derecho
G52193	B		
F	12-14	NISSAN	CUBE Todos Izquierdo
F	06	TIIDA	
F	07-12	TIIDA	Todos Izquierdo Modelos S y SL
G52194	A		
F	12-14	NISSAN	CUBE Todos Derecho
F	06	TIIDA	
F	07-12	TIIDA	Todos Derecho Modelos S y SL
G52199	D		
F	04-10	BMW	X3 Todos Izquierdo
G52200	D		
F	04-10	BMW	X3 Todos Derecho
G52201	D		
F	08-13	TOYOTA	HIGHLANDER Todos Izquierdo
G52202	D		
F	08-13	TOYOTA	HIGHLANDER Todos Derecho
G52203	D		
R	08-13	TOYOTA	HIGHLANDER 4x2 Tracción delantera Izquierdo
G52204	D		
R	08-13	TOYOTA	HIGHLANDER 4x2 Tracción delantera Derecho
G52205	D		
F	07-10	FORD	EXPLORER SPORT TRAC Todos
G52206	D		
R	07-10	FORD	EXPLORER SPORT TRAC Todos
G52209	C		
F	06	MAZDA	CX-7
F	07-10	CX-7	Todos Izquierdo

Lista numérica

Amort.	POP	No. Alternativo	Montaje Accesorio
Pos.	Año	Aplicación	
G52210	C		
F	07-10	MAZDA	CX-7 Todos Derecho
G52211	B		
F	07	NISSAN	120I
F	07-10	APRIO	
F	10-12	RENAULT	SANDERO / SANDERO STEPWAY
G52213	C		
F	06-10	VOLKSWAGEN	SPORTVAN
G52214	D		
F	03-10	PEUGEOT	307
G52215	D		
F	03-10	PEUGEOT	307
G52216	D		
F	07-11	RENAULT	TRAFIC
G52217	B		
F	05-14	VOLKSWAGEN	CROSSFOX
F	10-12	SAVEIRO	
G52218	B		
F	09-14	VOLKSWAGEN	GOL
G52220	C		
F	07-13	FORD	TRANSIT
G52221	D		
F	05-08	NISSAN	MICRA
G52222	D		
F	04-08	NISSAN	MICRA
G52223	A		
F	06-15	CHEVROLET	MATIZ G2
F	06-13	PONTIAC	G2
G52224	A		
F	06-15	CHEVROLET	MATIZ G2
F	06-13	PONTIAC	G2
G52225	B		
F	04-11	CHEVROLET	TORNADO
G52226	B		
F	04-11	CHEVROLET	TORNADO
G52227	D		
F	97-03	MITSUBISHI	DIAMANTE Todos Izquierdo
G52228	D		
F	97-03	MITSUBISHI	DIAMANTE Todos Derecho
G52235	D		
F	00	BMW	323Ci Coupe Izquierdo Suspensión Deportiva
F	01-06	325Ci	Todos Izquierdo Suspensión Deportiva
F	00	328Ci	Todos Izquierdo Suspensión Deportiva
F	01-06	330Ci	Todos Izquierdo Suspensión Deportiva
F	01-05	330i	Todos Izquierdo Suspensión Deportiva
G52236	D		
F	00	BMW	323Ci Coupe Derecho Suspensión Deportiva
F	01-06	325Ci	Todos Derecho Suspensión Deportiva
F	00	328Ci	Todos Derecho Suspensión Deportiva
F	02-06	330Ci	Todos Derecho Suspensión Deportiva
F	01	330Ci Coupe	Derecho Suspensión Deportiva
F	02-05	330i	Todos Derecho Suspensión Deportiva
G52237	D		
F	00	BMW	323Ci Coupe Izquierdo Exc. Suspensión Deportiva
F	00	323i	Wagon Izquierdo Exc. Suspensión Deportiva
F	01-06	325Ci	Todos Izquierdo Exc. Suspensión Deportiva
F	01-05	325i	Sedan Izquierdo Exc. Suspensión Deportiva
F	00	328Ci	Coupe Izquierdo Exc. Suspensión Deportiva
F	01-06	330Ci	Convertible Izquierdo Exc. Suspensión Deportiva

Lista numérica

Amort.	POP	No. Alternativo	Montaje Accesorio
Pos.	Año	Aplicación	
G52238	D		
F 00	BMW 323CI Coupe Derecho Exc. Suspensión Deportiva		
F 00	323I Wagon Derecho Exc. Suspensión Deportiva		
F 01-06	325CI Todos Derecho Exc. Suspensión Deportiva		
F 02-05	325I Sedan Derecho Exc. Suspensión Deportiva		
F 01	325I Sedan Derecho Fab. desde 11/01; Exc. Suspensión Deportiva		
F 00	328CI Coupe Derecho Exc. Suspensión Deportiva		
F 01-06	330CI Convertible Derecho Exc. Suspensión Deportiva		
G52244	D		
R 05-09	BUICK ALLURE Todos Modelos con Llantas de 17" o 18"		
R 05-09	LACROSSE Todos Modelos con Llantas de 17" o 18"		
R 04-11	CHEVROLET IMPALA Todos Modelos con Llantas de 17" o 18"		
R 05-07	MONTE CARLO Todos Modelos con Llantas de 17" o 18"		
R 04-08	PONTIAC GRAND PRIX Todos Modelos con Llantas de 17" o 18"		
G52245	C		
F 09-10	PONTIAC VIBE Todos Izquierdo		
F 09-13	TOYOTA COROLLA Todos Izquierdo		
F 09-13	MATRIX Todos Izquierdo		
G52246	C		
F 09-10	PONTIAC VIBE Todos Derecho		
F 09-13	TOYOTA COROLLA Todos Derecho		
F 09-13	MATRIX Todos Derecho		
G52247	FF		
F 07-10	KIA MAGENTIS Todos Izquierdo		
F 06-10	OPTIMA Todos Izquierdo		
F 07-11	RONDO Todos Izquierdo		
G52248	FF		
F 07-10	KIA MAGENTIS Todos Derecho		
F 06-10	OPTIMA Todos Derecho		
F 07-11	RONDO Todos Derecho		
G52249	D		
F 07-13	ACURA MDX Todos Izquierdo Exc. Suspensión Activa		
G52250	D		
F 07-13	ACURA MDX Todos Derecho Exc. Suspensión Activa		
G52253	D		
F 08-10	HONDA ODYSSEY Todos Izquierdo		
G52254	D		
F 08-10	HONDA ODYSSEY Todos Derecho		
G52255	C		
F 11-13	FORD FIESTA Todos Izquierdo		
F 11	MAZDA 2 Todos Izquierdo		
G52256	C		
F 11-13	FORD FIESTA Todos Derecho		
F 11	MAZDA 2 Todos Derecho		
G52257	N		
F 07-08	HYUNDAI ENTOURAGE Todos Izquierdo		
F 06-11	KIA SEDONA Todos Izquierdo		
G52258	N		
F 07-08	HYUNDAI ENTOURAGE Todos Derecho		
F 06-11	KIA SEDONA Todos Derecho		
G52260	C		
F 07-10	MAZDA CX-9 Todos Izquierdo		
G52261	C		
F 07-10	MAZDA CX-9 Todos Derecho		
G52262	C		
F 08-10	MINI COOPER LANCER DE Izquierdo		
F 08-10	LANCER ES Izquierdo		
G52263	C		
F 08-10	MINI COOPER LANCER Todos Derecho		
F 08-10	LANCER ES Derecho		
G52264	FF		
F 08-12	SCION XB Todos Izquierdo		

Struts Ultra

Amort.	POP	No. Alternativo	Montaje Accesorio
Pos.	Año	Aplicación	
G52265	FF		
F 08-12	SCION XB Todos Derecho		
G52268	FF		
F 08-10	SCION XD Todos Izquierdo		
G52269	FF		
F 08-10	SCION XD Todos Derecho		
G52270	FF		
F 06-07	SUBARU B9 TRIBECA Todos Izquierdo		
F 08-13	TRIBECA Todos Izquierdo		
G52271	FF		
F 06-07	SUBARU B9 TRIBECA Todos Derecho		
F 08-13	TRIBECA Todos Derecho		
G52272	N		
F 05-12	SUBARU OUTBACK Todos Izquierdo		
G52273	N		
F 05-12	SUBARU OUTBACK Todos Derecho		
G52274	D		
F 08-12	VOLVO C30 Todos Izquierdo		
F 06-11	C70 Todos Izquierdo		
F 05-09	S40 Todos Izquierdo		
F 04	S40 T5 Izquierdo		
F 05-09	V50 Todos Izquierdo		
G52275	D		
F 08-12	VOLVO C30 Todos Derecho		
F 06-11	C70 Todos Derecho		
F 05-09	S40 Todos Derecho		
F 04	S40 T5 Derecho		
F 05-09	V50 Todos Derecho		
G52276	D		
F 02-08	JAGUAR X-TYPE Todos Exc. Suspensión de tecnología computarizada activa (CATS)		
G52278	D		
F 10	BUICK ALLURE 4x2 Tracción delantera Izquierdo Exc. Suspensión Electrónica Ajustable		
F 10-12	LACROSSE 4x2 Tracción delantera Izquierdo Exc. Suspensión Electrónica Ajustable		
G52279	D		
F 10	BUICK ALLURE 4x2 Tracción delantera Derecho Exc. Suspensión Electrónica Ajustable		
F 10-12	LACROSSE 4x2 Tracción delantera Derecho Exc. Suspensión Electrónica Ajustable		
G52280	D		
F 10-13	CHEVROLET CAMARO 3.6L 6Cyl V (217) Izquierdo		
G52281	D		
F 10-13	CHEVROLET CAMARO 3.6L 6Cyl V (217) Derecho		
G52282	D		
F 07-08	HONDA FIT Todos Izquierdo		
G52283	D		
F 07-08	HONDA FIT Todos Derecho		
G52293	FF		
F 04-11	MINI COOPER LANCER DE Izquierdo		
G52294	FF		
F 04-11	MINI COOPER LANCER ES Izquierdo		
G52295	D		
F 03-08	VOLVO XC90 Todos		
G52297	D		
F 07-12	MINI COOPER Todos Izquierdo		
G52298	D		
F 07-12	MINI COOPER Todos Derecho		
G52299	D		
F 09-13	MINI COOPER LANCER DE Izquierdo w/ 3rd Row Seating		
F 09-13	LANCER ES Izquierdo w/ 3rd Row Seating		

Lista numérica

Amort.	POP	No. Alternativo	Montaje Accesorio
Pos.	Año	Aplicación	
G52299	D		
F 10-12	OUTLANDER GT Izquierdo w/ 3rd Row Seating		
F 08	OUTLANDER XLS Izquierdo		
F 07	OUTLANDER Todos Izquierdo		
G52300	D		
F 10-13	MINI COOPER LANCER DE Izquierdo w/ 3rd Row Seating		
F 09-13	OUTLANDER SE Derecho w/ 3rd Row Seating		
F 09-13	OUTLANDER XLS Derecho w/ 3rd Row Seating		
F 08	OUTLANDER XLS Derecho		
F 07	OUTLANDER Todos Derecho		
G52301	D		
F 09-11	VOLKSWAGEN TIGUAN		
F 09-11	TIGUAN Todos		
G52311	FF		
F 08-12	AUDI A3 Todos Exc. S3 y suspensión electrónica, con cilindro exterior de 50 mm		
F 06-14	VOLKSWAGEN BORA		
F 11-13	GOLF		
F 11-13	GTI		
F 11-13	JETTA		
G52312	A		
F 10-15	CHEVROLET SPARK		
G52313	A		
F 10-15	CHEVROLET SPARK		
G52314	N		
F 04-07	BMW 525I Todos		
F 08-10	528I Todos		
F 04-07	530I Todos		
F 08-10	535I Todos		
F 04-05	545I Todos		
F 06-10	550I Todos		
G52316	C		
F 09	FORD ECOSPORT		
F 10-11	ECOSPORT Todos		
G52327	FF		
F 10-13	HONDA CIVIC Todos Izquierdo		
G52328	FF		
F 10-13	HONDA CIVIC Todos Derecho		
G52329	FF		
F 11	HYUNDAI SONATA 2.0T Izquierdo Fab. hasta 7/22/10		
F 11	SONATA 2.0T Limited Izquierdo Fab. hasta 7/22/10		
F 11	SONATA GL Izquierdo Fab. hasta 7/22/10		
F 11	SONATA GLS Izquierdo Fab. hasta 7/22/10		
F 11	SONATA Limited Izquierdo Fab. hasta 7/22/10		
F 11	SONATA SE Izquierdo Fab. hasta 7/22/10		
G52330	FF		
F 11	HYUNDAI SONATA 2.0T Limited Derecho Fab. hasta 7/22/10		
F 11	SONATA 2.0T Derecho Fab. hasta 7/22/10		
F 11	SONATA GL Derecho Fab. hasta 7/22/10		
F 11	SONATA GLS Derecho Fab. hasta 7/22/10		
F 11	SONATA Limited Derecho Fab. hasta 7/22/10		
F 11	SONATA SE Derecho Fab. hasta 7/22/10		
G52331	D		
F 10-12	TOYOTA PRIUS Todos Izquierdo Fab. hasta 12/2011		
G52332	D		
F 10-12	TOYOTA PRIUS Todos Derecho Fab. hasta 12/2011		
G52333	FF		
R 00-05	HYUNDAI ACCENT Todos Izquierdo Gas Charged Unit		
G52334	FF		
R 00-05	HYUNDAI ACCENT Todos Derecho Gas Charged Unit		

Lista numérica

Amort.	POP	No. Alternativo	Montaje Accesorio
Pos.	Año	Aplicación	
G52335	N		
R 96-99	HYUNDAI ELANTRA Todos Izquierdo Gas Charged Unit		
G52336	N		
R 96-99	HYUNDAI ELANTRA Todos Derecho Gas Charged Unit		
G52337	FF		
F 10-13	PEUGEOT 207		
F 08	207		
G52338	W		
F 10-13	PEUGEOT 207		
F 08	207		
G52339	B		
F 11-15	NISSAN MARCH		
G52340	B		
F 11-15	NISSAN MARCH		
G52341	B		
F 07-10	MERCEDES-BENZ SPRINTER 415 & 515		
F 10-11	VOLKSWAGEN CRAFTER VAN		
G52342	C		
F 05-12	VOLKSWAGEN EUROVAN		
F 10-14	TRANSPORTER Todos		
G52343	FF		
F 07-10	MERCEDES-BENZ SPRINTER 315		
F 08-11	VW CRAFTER		
F 08-13	VOLKSWAGEN CRAFTER Todos		
G52344	C		
F 07-11	TOYOTA AVANZA		
G52345	C		
F 07-11	TOYOTA AVANZA		
G52346	D		
F 05-06	ACURA RSX Todos Izquierdo		
G52347	D		
F 05-06	ACURA RSX Todos Derecho		
G52348	D		
F 03-10	PORSCHE CAYENNE		
F 04-09	VOLKSWAGEN TOUAREG		
F 04-09	TOUAREG Todos Izquierdo		
G52349	D		
F 03-10	PORSCHE CAYENNE		
F 04-09	VOLKSWAGEN TOUAREG		
F 04-09	TOUAREG Todos Derecho		
G52351	FF		
F 11-14	FORD EDGE Todos Izquierdo		
F 11-14	LINCOLN MKX Todos Izquierdo		
G52352	FF		
F 11-14	FORD EDGE Todos Derecho		
F 11-14	LINCOLN MKX Todos Derecho		
G52353	FF		
F 12-14	DODGE ATTITUDE Todos Izquierdo		
F 14-16	HYUNDAI ACCENT Todos Izquierdo		
F 14-15	KIA RIO Todos Izquierdo		
G52354	FF		
F 12-14	DODGE ATTITUDE Todos Derecho		
F 14-16	HYUNDAI ACCENT Todos Derecho		
F 14-15	KIA RIO Todos Derecho		
G52355	FF		
F 11-13	NISSAN QUEST Todos Izquierdo		
G52356	FF		
F 11-13	NISSAN QUEST Todos Derecho		
G52359	FF		
F 04-06	SUZUKI VERONA Todos Izquierdo		
G52360	D		
F 09-12	HONDA PILOT Todos Izquierdo		
G52361	D		
F 09-12	HONDA PILOT Todos Derecho		
G52362	FF		
F 04-06	MITSUBISHI GALANT LS Izquierdo		
G52363	FF		
F 04-06	MITSUBISHI GALANT LS Derecho		
G52365	N		
F 05-06	TOYOTA AVALON Todos Izquierdo		

Struts Ultra

Amort.	POP	No. Alternativo	Montaje Accesorio
Pos.	Año	Aplicación	
G52366	N		
F 05-06	TOYOTA AVALON Todos Izquierdo		
G52367	N		
R 05-06	TOYOTA AVALON Todos Izquierdo		
G52368	N		
R 05-06	TOYOTA AVALON Todos Derecho		
G52369	FF		
F 10-13	FORD TRANSIT CONNECT Todos Izquierdo		
G52370	FF		
F 10-13	FORD TRANSIT CONNECT Todos Derecho		
G52374	FF		
F 09-12	SUBARU FORESTER Todos Izquierdo		
G52375	FF		
F 09-12	SUBARU FORESTER Todos Derecho		
G52376	N		
F 04	TOYOTA AVALON Todos Izquierdo		
G52377	N		
F 04	TOYOTA AVALON Todos Derecho		
G52380	N		
R 08-13	TOYOTA HIGHLANDER AWD Izquierdo		
G52381	N		
R 08-13	TOYOTA HIGHLANDER AWD Derecho		
G52382	FF		
F 09-14	NISSAN MAXIMA Todos Izquierdo		
G52383	FF		
F 09-14	NISSAN MAXIMA Todos Derecho		
G52384	FF		
F 10-12	FORD FLEX Todos Izquierdo		
F 10-12	LINCOLN MKT Todos Izquierdo		
G52385	FF		
F 10-12	FORD FLEX Todos Derecho		
F 10-12	LINCOLN MKT Todos Derecho		
G52386	FF		
F 02-03	SUBARU IMPREZA Wagon Izquierdo		
G52387	FF		
F 02-03	SUBARU IMPREZA Wagon Derecho		
G52390	FF		
F 04-06	SUZUKI VERONA Todos Derecho		
G52393	FF		
R 00-05	TOYOTA MR2 Todos Izquierdo		
G52394	FF		
R 00-05	TOYOTA MR2 Todos Derecho		
G52395	FF		
F 10-15	CHEVROLET CAMARO SS Izquierdo		
G52396	FF		
F 10-15	CHEVROLET CAMARO SS Derecho		
G52398	FF		
F 10-12	FORD TAURUS Todos Izquierdo w/ Suspensión Code A y B		
F 09-12	LINCOLN MKS Todos Izquierdo w/ Suspensión Code A y B		
G52399	FF		
F 10-12	FORD TAURUS Todos Derecho w/ Suspensión Code A y B		
F 09-12	LINCOLN MKS Todos Derecho w/ Suspensión Code A y B		
G52400	FF		
F 08-09	FORD TAURUS X Todos Izquierdo		
G52401	FF		
F 08-09	FORD TAURUS X Todos Derecho		
G52406	FF		
F 11-14	FORD MUSTANG / MUSTANG II Todos		

Lista numérica

Amort.	POP	No. Alternativo	Montaje Accesorio
Pos.	Año	Aplicación	
G52410	FF		
F 12-16	NISSAN ROGUE		
G52411	FF		
F 12-16	NISSAN ROGUE		
G52412	N		
R 04	TOYOTA AVALON Todos Izquierdo		
G52413	N		
R 04	TOYOTA AVALON Todos Derecho		
G52418	FF		
F 12-13	NISSAN ROGUE S Izquierdo		
F 12-13	ROGUE SL Izquierdo		
G52419	FF		
F 12-13	NISSAN ROGUE S Derecho		
F 12-13	ROGUE SV Derecho		
G52420	FF		
F 13	FORD ESCAPE Todos Izquierdo		
G52421	FF		
F 13	FORD ESCAPE Todos Derecho		
G52422	FF		
F 12-13	FORD FOCUS Todos Izquierdo		
G52423	FF		
F 12-13	FORD FOCUS Todos Derecho		
G52425	FF		
F 12-15	TOYOTA CAMRY SE Izquierdo		
F 14	CAMRY SE Sport Izquierdo		
G52426	FF		
F 12-15	TOYOTA CAMRY SE Derecho		
F 14	CAMRY SE Sport Derecho		
G52428	FF		
F 13-14	HONDA ACCORD Todos Izquierdo		
G52429	FF		
F 13-14	HONDA ACCORD Todos Derecho		
G52432	C		
F 12-16	BUICK VERANO Todos Izquierdo		
F 11-16	CHEVROLET CRUZE Todos Izquierdo		
G52433	C		
F 12-16	BUICK VERANO Todos Derecho		
F 11-16	CHEVROLET CRUZE Todos Derecho		
G52435	FF		
F 11-12	BUICK REGAL Todos Izquierdo Exc. Suspensión Activa		
G52436	FF		
F 11-12	BUICK REGAL Todos Derecho Exc. Suspensión Activa		
G52437	FF		
F 12-15	HYUNDAI AZERA Todos Izquierdo		
G52438	FF		
F 12-15	HYUNDAI AZERA Todos Derecho		
G52439	FF		
F 12-13	HYUNDAI ELANTRA Todos Izquierdo		
F 13	ELANTRA COUPE Todos Izquierdo		
G52440	FF		
F 12-13	HYUNDAI ELANTRA Todos Derecho		
F 13	ELANTRA COUPE Todos Derecho		
G52447	FF		
F 10-15	LEXUS RX350 Todos Izquierdo w/o Air Suspensión		
G52448	FF		
F 10-15	LEXUS RX350 Todos Derecho w/o Air Suspensión		
G52449	FF		
F 07-13	MAZDA 3 Todos Izquierdo		
G52450	FF		
F 07-13	MAZDA 3 Todos Derecho		
G52452	FF		
F 11-14	NISSAN JUKE		

Lista numérica

Amort.	POP	No. Alternativo	Montaje Accesorio
Pos.	Año	Aplicación	
G52453	C		
F	12-15	NISSAN MARCH Todos Izquierdo Con barra estabilizadora	
F	14-16	NOTE Todos Izquierdo	
F	13-16	VERSA Todos Izquierdo	
G52454	C		
F	12-15	NISSAN MARCH Todos Derecho Con barra estabilizadora	
F	14-16	NOTE Todos Derecho	
F	13-16	VERSA Todos Derecho	
G52459	FF		
F	12-13	DODGE H100 GAS Izquierdo	
F	11	H100 Todos Izquierdo Gas	
F	08-09	H100 Todos Derecho Gas	
F	10	H100 TRUCK Truck Izquierdo Gas	
F	10	H100 VAN Van Izquierdo Gas	
G52460	FF		
F	12-13	DODGE H100 GAS Derecho	
F	11	H100 Todos Derecho Gas	
F	08-09	H100 Todos Derecho Gas	
F	10	H100 TRUCK Truck Derecho Gas	
F	10	H100 VAN Van Derecho Gas	
G52485	FF		
R	12-13	TOYOTA CAMRY Hybrid LE Izquierdo	
R	12-13	CAMRY Hybrid XLE Izquierdo	
R	12-13	CAMRY SE Izquierdo	
R	12-13	CAMRY XLE Izquierdo	
G52486	FF		
R	12-13	TOYOTA CAMRY Hybrid LE Derecho	
R	12-13	CAMRY Hybrid XLE Derecho	
R	12-13	CAMRY SE Derecho	
R	12-13	CAMRY XLE Derecho	
G52491	FF		
F	09-12	FIAT 500 Todos Izquierdo	
G52492	FF		
F	09-12	FIAT 500 Todos Derecho	
G52494	N		
F	13-14	CHEVROLET TRAX Todos Izquierdo	
G52495	N		
F	13-14	CHEVROLET TRAX Todos Derecho	
G52502	FF		
F	13-16	DODGE DART Todos Izquierdo Touring Suspensión	
G52503	FF		
F	13-16	DODGE DART Todos Derecho Touring Suspensión	
G52507	FF		
F	07-11	HONDA ELEMENT Todos Izquierdo	
G52508	FF		
F	07-11	HONDA ELEMENT Todos Derecho	
G52519	FF		
F	12-13	MAZDA 5 Todos Izquierdo	
G52520	FF		
F	12-13	MAZDA 5 Todos Derecho	
G52522	W		
F	11-16	NISSAN LEAF Todos Izquierdo	
G52523	W		
F	11-16	NISSAN LEAF Todos Derecho	
G52524	FF		
F	13-16	NISSAN PATHFINDER Todos Izquierdo	
G52525	FF		
F	13-16	NISSAN PATHFINDER Todos Derecho	
G52528	FF		
F	13-15	NISSAN SENTRA	
G52529	FF		
F	13-15	NISSAN SENTRA	
G52585	FF		
F	12-13	AUDI A1 Union Square	
F	11-13	A1 Cool	
F	11-13	A1 Ego	
F	11-13	A1 Envy	

Struts Ultra

Amort.	POP	No. Alternativo	Montaje Accesorio
Pos.	Año	Aplicación	
G52585	FF		-continued
F	11-12	A1 Sport One	
F	08-16	SEAT IBIZA	
F	13-15	TOLEDO	
F	14	VOLKSWAGEN POLO Todos	
F	14-16	VENTO Todos	
G52586	FF		
F	07-11	SUZUKI SWIFT Todos Izquierdo	
G52587	FF		
F	07-11	SUZUKI SWIFT Todos Derecho	
G52588	FF		
F	06-08	HONDA FIT Todos Izquierdo	
G52589	FF		
F	06-08	HONDA FIT Todos Derecho	
G52590	FF		
F	99-05	TOYOTA YARIS	
G52591	FF		
F	15-16	CHEVROLET CITY EXPRESS Todos Izquierdo	
F	13-16	NISSAN NV200 Todos Izquierdo	
G52592	FF		
F	15-16	CHEVROLET CITY EXPRESS Todos Derecho	
F	13-16	NISSAN NV200 Todos Derecho	
G52594	FF		
F	08-13	SUBARU IMPREZA Todos Izquierdo	
G52595	FF		
F	08-13	SUBARU IMPREZA Todos Derecho	
G52600	FF		
F	10	BUICK ALLURE AWD Izquierdo Exc. Suspensión Electrónica Ajustable	
F	10-12	LACROSSE AWD Izquierdo Exc. Suspensión Electrónica Ajustable	
G52601	FF		
F	10	BUICK ALLURE AWD Derecho Exc. Suspensión Electrónica Ajustable	
F	10-12	LACROSSE AWD Derecho Exc. Suspensión Electrónica Ajustable	
G52622	FF		
F	13-16	CADILLAC ATS AWD Izquierdo	
G52623	FF		
F	13-16	CADILLAC ATS AWD Derecho	
G52624	N		
F	00-05	TOYOTA MR2	
G52625	N		
F	00-05	TOYOTA MR2	
G52626	FF		
F	09-12	A4 & A4 QUATTRO	
G52638	FF		
R	02-05	LAND ROVER FREELANDER Todos Izquierdo	
G52639	FF		
R	02-05	LAND ROVER FREELANDER Todos Derecho	
G52665	W		
F	11-17	HONDA ODYSSEY Todos Izquierdo	
G52666	W		
F	11-17	HONDA ODYSSEY Todos Derecho	
G52698	FF		
F	14-16	NISSAN MAXIMA	
G52699	FF		
F	14-16	NISSAN MAXIMA	
G52726	FF		
F	11-14	NISSAN MURANO	
G52727	FF		
F	15-16	NISSAN MURANO	
G52728	FF		
F	15-16	NISSAN MURANO	
G52736	W		
R	14-15	TOYOTA CAMRY Hybrid LE Izquierdo	
R	14-15	CAMRY Hybrid SE Izquierdo	
R	14-15	CAMRY Hybrid XLE Izquierdo	

Lista numérica

Amort.	POP	No. Alternativo	Montaje Accesorio
Pos.	Año	Aplicación	
G52736	W		-continued
R	14-15	CAMRY XLE Izquierdo	
G52737	W		
R	14-15	TOYOTA CAMRY Hybrid LE Derecho	
R	14-15	CAMRY Hybrid SE Derecho	
R	14-15	CAMRY Hybrid XLE Derecho	
R	14-15	CAMRY XLE Derecho	
G52742	FF		
F	13-15	CHEVROLET MALIBU Todos Izquierdo	
G52743	FF		
F	13-15	CHEVROLET MALIBU Todos Derecho	
G52837	N		
F	05-08	CHEVROLET TRACKER	
G52838	N		
F	05-08	CHEVROLET TRACKER	
G52855	N		
F	12-14	HYUNDAI I10	
G52856	N		
F	12-14	HYUNDAI I10	
G52886	N		
F	02-08	SEAT ALHAMBRA	
F	02-08	VOLKSWAGEN SHARAN	
G52887	N		
F	07-11	FORD FOCUS	
G52888	N		
F	07-11	FORD FOCUS	
G52900	W		
F	11-15	CHEVROLET TORNADO	
G55505	D		141309
F	84	BUICK CENTURY Todos Exc. Suspensión HD	
F	82-83	CENTURY Todos	
F	84	SKYLARK Todos Exc. Suspensión HD	
F	80-83	SKYLARK Todos	
F	84	CHEVROLET CELEBRITY Todos Exc. Suspensión HD	
F	82-83	CELEBRITY Todos	
F	84-85	CITATION / CITATION II Todos Exc. Suspensión HD	
F	80-83	CITATION / CITATION II Todos	
F	84	OLDSMOBILE CIERA / CUTLASS CIERA Todos Exc. Suspensión HD	
F	82-83	CIERA / CUTLASS CIERA Todos	
F	84	OMEGA Todos Exc. Suspensión HD	
F	80-83	OMEGA Todos	
F	84	PONTIAC 6000 Todos Exc. Suspensión HD	
F	82-83	6000 Todos	
F	84	PHOENIX Todos Exc. Suspensión HD	
F	80-83	PHOENIX Todos	
G55507	D		140896
F	82-83	CHRYSLER DART K	
F	83	E CLASS Todos	
F	83	EXECUTIVE SEDAN Todos	
F	81-83	LEBARON Todos	
F	82-83	MAGNUM K	
F	83	NEW YORKER Todos	
F	82-83	DODGE 400 Todos	
F	83	600 Todos	
F	81-83	ARIES Todos	
F	83-87	CHARGER Todos	
F	82-83	DART K	
F	78-89	OMNI Todos	
F	82-84	RAMPAGE Todos	
F	83	PLYMOUTH CARAVELLE Todos	
F	87-89	EXPO Todos	
F	78-89	HORIZON Todos	
F	81-83	RELIANT Todos	
F	85	TURISMO Todos	
F	83	TURISMO Todos	
G55509	X		141309
F	86	DODGE CARAVAN / GRAND CARAVAN Todos Fab. hasta 2/86	
F	84-85	CARAVAN / GRAND CARAVAN Todos	
F	86	PLYMOUTH VOYAGER / GRAND VOYAGER Todos Fab. hasta 2/86	

Lista numérica

Amort.	POP	No. Alternativo	Montaje Accesorio
Pos.	Año	Aplicación	
G55509	X	-continued	141309
F	84-85	VOYAGER / GRAND VOYAGER Todos	
G55510	W		141038
F	82-87	LINCOLN CONTINENTAL Todos	
F	84-92	MARK VII Todos	
G55511	W		141309
F	84-85	CHRYSLER DART K	
F	84-85	DAYTONA Todos	
F	84	E CLASS Todos	
F	85	EXECUTIVE LIMOUSINE Todos	
F	84	EXECUTIVE SEDAN Todos	
F	84-85	LASER Todos	
F	84-85	LEBARON Todos	
F	84-85	MAGNUM K	
F	84-85	NEW YORKER Todos	
F	84-85	DODGE 600 Todos	
F	84-85	ARIES Todos	
F	84-85	DART K	
F	84-85	DAYTONA Todos	
F	85	LANCER Todos	
F	84-85	MAGNUM K	
F	84-85	PLYMOUTH CARAVELLE Todos	
F	84-85	RELIANT Todos	
F	84-85	VOLARE K	
G55512	W		141309
R	84-87	PONTIAC FIERO Todos	
G55514	C		142699
F	84-96	BUICK CENTURY Todos Suspensión HD	
F	85	SKYLARK Todos	
F	84	SKYLARK Todos Suspensión HD	
F	85-90	CHEVROLET CELEBRITY Todos	
F	84	CELEBRITY Todos Suspensión HD	
F	86-88	CITATION	
F	84-85	CITATION / CITATION II Todos Suspensión HD	
F	86-97	CUTLASS	
F	91-96	EUROSPORT	
F	85-96	OLDSMOBILE CIERA / CUTLASS CIERA Todos Exc. Suspensión Electrónica Ajustable	
F	84	CIERA / CUTLASS CIERA Todos Suspensión HD	
F	87-94	CUTLASS CLASSIC / CUTLASS CRUISER Todos Exc. Suspensión Electrónica Ajustable	
F	84	OMEGA Todos Suspensión HD	
F	91	PONTIAC 6000 4x2 Tracción delantera Suspensión HD	
F	84-90	6000 Todos Suspensión HD	
F	84	PHOENIX Todos Suspensión HD	
G55515	D		141393
F	82-85	HONDA ACCORD Todos	
G55516	D		141393
R	82-85	HONDA ACCORD Todos	
R	83-87	PRELUDE Todos Struts Traseros Sellados	
G55518	D		
R	86-93	FORD TAURUS Sedan	
R	86-93	MERCURY SABLE Sedan	
G55521	D		141682
F	86-88	NISSAN MAXIMA Sedan Exc. Suspensión Electrónica Ajustable	
F	87-89	STANZA Sedan	
G55525	B		
F	90-95	CHRYSLER TOWN & COUNTRY Todos	
F	87-95	DODGE CARAVAN / GRAND CARAVAN Todos	
F	86	CARAVAN / GRAND CARAVAN Todos Fab. desde 1/86	
F	87-88	MINI RAM Todos	
F	87-95	PLYMOUTH VOYAGER / GRAND VOYAGER Todos	
F	86	VOYAGER / GRAND VOYAGER Todos Fab. desde 1/86	
G55526	B		
F	86-89	CHRYSLER DART K	
F	86-93	DAYTONA Todos	
F	88-93	DYNASTY Todos Exc. Sistema de Autonivelación NIVOMAT	
F	90-93	IMPERIAL Todos Exc. Sistema de Autonivelación NIVOMAT	
F	86	LASER Todos	
F	86-95	LEBARON Todos	

Struts Ultra

Amort.	POP	No. Alternativo	Montaje Accesorio
Pos.	Año	Aplicación	
G55526	B	-continued	
F	86-89	MAGNUM K	
F	86-93	NEW YORKER Todos	
F	88-94	SHADOW	
F	86-88	TOWN & COUNTRY Todos	
F	86-88	DODGE 600 Todos	
F	86-89	ARIES Todos	
F	86-89	DART K	
F	89-93	DAYTONA ES	
F	87-88	DAYTONA Pacifica	
F	86	DAYTONA Todos	
F	88-93	DYNASTY Todos Exc. Sistema de Autonivelación NIVOMAT	
F	86-89	LANCER Todos	
F	87-94	SHADOW Todos	
F	89-95	SPIRIT Todos	
F	93-95	SPIRIT RT	
F	89-90	SPIRIT RT	
F	89-95	PLYMOUTH ACCLAIM Todos	
F	86-88	CARAVELLE Todos	
F	86-89	RELIANT Todos	
F	87-94	SUNDANCE Todos	
F	86-88	VOLARE K	
G55527	W		141309
F	84-89	MERCEDES-BENZ 190D Todos	
F	84-93	190E Todos	
F	87-89	260E Todos Exc. 4 Matic 4x4	
F	90-93	300D Todos Exc. 4 Matic 4x4	
F	87	300D Todos Exc. 4 Matic 4x4	
F	86-93	300E Todos Exc. 4 Matic 4x4	
F	92-93	400E / 400SE / 400SEL / 420SEL / 450SE / 450SEL Todos	
F	95	E300 Todos	
F	94-95	E320 Todos	
F	94-95	E420 Todos	
F	94	E500 Todos	
G55529	W		141687
R	86-87	TOYOTA CELICA Todos	
G55542	W		141685
F	86-91	MAZDA RX7 Todos Exc. Suspensión Electrónica Ajustable	
G55544	D		141690
R	86-89	MAZDA 323 4x2 Tracción delantera Exc. Suspensión Electrónica Ajustable	
R	81-85	GLC Hatchback	
R	81-85	GLC Sedan	
R	87-89	MERCURY TRACER 4x2 Tracción delantera	
G55551	D		141306
F	84-93	FORD MUSTANG / MUSTANG II GT, 5.0L 8Cyl V (302)	
G55557	D		141718
R	89-92	GEO PRIZM Todos	
R	88-92	TOYOTA COROLLA 4x2 Tracción delantera	
G55561	W		141682
F	87-88	DODGE COLT Hatchback	
F	87-88	COLT Sedan	
F	89-92	EAGLE VISTA Sedan	
F	89-91	VISTA Hatchback	
F	87-88	NISSAN MIRAGE Todos	
F	88-90	PLYMOUTH COLT DL, Wagon	
F	87	COLT Hatchback	
F	87	COLT Sedan	
G55579	D		141730
F	89-97	FORD THUNDERBIRD Todos Exc. Suspensión Electrónica Ajustable	
F	89-97	MERCURY COUGAR Todos Exc. Suspensión Electrónica Ajustable	
G55586	W		141682
F	90-94	HYUNDAI EXCEL Todos	
F	91-95	SCOUPE Todos	
F	90-94	NISSAN PRECIS Todos	
G55587	D		141682
F	90	EAGLE TALON AWD	
F	90	TALON 4x2 Tracción delantera	
F	90	NISSAN ECLIPSE Todos	
F	90-94	PLYMOUTH LASER 4x2 Tracción delantera	
G55588	D		142018
R	87-91	TOYOTA CAMRY Wagon	
G55589	D		142018
R	90-91	LEXUS ES250 Todos	

Lista numérica

Amort.	POP	No. Alternativo	Montaje Accesorio
Pos.	Año	Aplicación	
G55589	D	-continued	142018
R	88-91	TOYOTA CAMRY Sedan, 4x2 Tracción delantera	
R	87	CAMRY Sedan	
G55590	D		142597
F	90-91	LEXUS ES250 Todos	
F	87-91	TOYOTA CAMRY Todos	
G55591	C		142024
F	89-92	GEO PRIZM Todos	
F	88-92	TOYOTA COROLLA 4x2 Tracción delantera	
G55592	W		141682
F	89-92	DODGE COLT Hatchback	
F	91-92	EAGLE SUMMIT Sedan	
F	89-90	SUMMIT Todos	
F	92-95	HYUNDAI ELANTRA Non-ABS	
F	89-92	NISSAN MIRAGE Todos	
F	89-91	PLYMOUTH COLT Hatchback	
G55594	X		141309
F	90	DODGE OMNI Todos	
F	90	PLYMOUTH HORIZON Todos	
G55597	FF		
R	96-97	FORD VAGONETA	
G55600	D		141715
F	89-92	FORD PROBE Todos	
F	88-92	MAZDA 626 Todos Exc. Suspensión Electrónica Ajustable o con dirección en las 4 ruedas	
F	88-92	MX6 Todos Exc. Suspensión Electrónica Ajustable o con dirección en las 4 ruedas	
G55601	D		141309
R	89-92	FORD PROBE Todos	
R	88-92	MAZDA 626 Todos Exc. Suspensión Electrónica Ajustable o con dirección en las 4 ruedas	
R	88-92	MX6 Todos Exc. Suspensión Electrónica Ajustable o con dirección en las 4 ruedas	
G55602	W		141323
F	91-93	MERCURY CAPRI Todos	
G55603	W		141690
R	91-93	MERCURY CAPRI Todos	
G55605	D		142174
F	91-93	EAGLE 2000 GTX Todos Exc. Sistema de Autonivelación	
F	92-96	SUMMIT Wagon	
F	91-94	TALON Todos	
F	91-94	NISSAN ECLIPSE Todos	
F	90-92	GALANT AWD	
F	92-94	PLYMOUTH COLT Wagon	
F	92-94	LASER AWD	
G55606	D		141687
R	90-93	TOYOTA CELICA 4x2 Tracción delantera	
G55607	D		142081
F	90-94	NISSAN AXXESS 4x2 Tracción delantera Izquierdo	
F	89-94	MAXIMA Todos Izquierdo Exc. Suspensión Electrónica Ajustable	
G55608	D		142081
F	90-94	NISSAN AXXESS 4x2 Tracción delantera Derecho	
F	89-94	MAXIMA Todos Derecho Exc. Suspensión Electrónica Ajustable	
G55609	X		142174
F	89-93	NISSAN GALANT 4x2 Tracción delantera	
G55610	D		142081
F	90-92	NISSAN STANZA Todos Izquierdo	
G55611	D		142081
F	90-92	NISSAN STANZA Todos Derecho	
G55615	C		141711
F	94-97	FORD ASPIRE Non-ABS	
F	88-93	FESTIVA Todos	
G55616	D		141309
F	86-95	FORD SABLE	
F	86-95	TAURUS Todos	
F	86-95	MERCURY SABLE Todos	

Lista numérica

Amort.	POP	No. Alternativo	Montaje Accesorio
Pos.	Año	Aplicación	
G55652	D		141682
F	91-97	TOYOTA PREVIA Todos Izquierdo	
G55653	D		141682
F	91-97	TOYOTA PREVIA Todos Derecho	
G55657	A		141682
F	93-94	NISSAN SENTRA Todos Izquierdo Suspensión Trasera Independiente B13	
F	92-05	TSUBAME	
F	92-18	TSURU	
G55658	A		141682
F	93-94	NISSAN SENTRA Todos Derecho Suspensión Trasera Independiente B13	
F	92-05	TSUBAME	
F	92-18	TSURU	
G55661	C		141309
R	98-02	CHEVROLET PRIZM Todos Izquierdo	
R	93-97	GEO PRIZM Todos Izquierdo	
R	93-02	TOYOTA COROLLA Todos Izquierdo	
G55662	C		141309
R	98-02	CHEVROLET PRIZM Todos Derecho	
R	93-97	GEO PRIZM Todos Derecho	
R	93-02	TOYOTA COROLLA Todos Derecho	
G55663	D		141309
F	99-04	CHRYSLER 300M Todos Izquierdo	
F	93-04	CONCORDE Todos Izquierdo	
F	93-04	INTREPID Todos Izquierdo	
F	99-01	LHS Todos Izquierdo	
F	94-97	LHS Todos Izquierdo	
F	94-96	NEW YORKER Todos Izquierdo	
F	93-04	DODGE INTREPID Todos Izquierdo	
F	93-97	EAGLE VISION Todos Izquierdo	
G55664	D		141309
F	99-04	CHRYSLER 300M Todos Derecho	
F	93-04	CONCORDE Todos Derecho	
F	93-04	INTREPID Todos Derecho	
F	99-01	LHS Todos Derecho	
F	94-97	LHS Todos Derecho	
F	94-96	NEW YORKER Todos Derecho	
F	93-04	DODGE INTREPID Todos Derecho	
F	93-97	EAGLE VISION Todos Derecho	
G55665	D		141309
R	93-97	CHRYSLER CONCORDE Todos	
R	93-97	INTREPID Todos	
R	94-97	LHS Todos	
R	94-96	NEW YORKER Todos	
R	93-97	DODGE INTREPID Todos	
R	93-97	EAGLE VISION Todos	
G55666	C		142081
F	93-97	NISSAN ALTIMA Todos Derecho	
G55667	C		142081
F	93-97	NISSAN ALTIMA Todos Izquierdo	
G55668	C		142868
R	93-01	NISSAN ALTIMA Todos Derecho	
G55669	C		142868
R	93-01	NISSAN ALTIMA Todos Izquierdo	
G55670	D		141309
F	93-97	FORD PROBE Todos Derecho	
F	93-97	MAZDA 626 Todos Derecho	
F	93-97	MX6 Todos Derecho	
G55671	D		141309
F	93-97	FORD PROBE Todos Izquierdo	
F	93-97	MAZDA 626 Todos Izquierdo	
F	93-97	MX6 Todos Izquierdo	
G55672	W		141309
R	93-97	FORD PROBE Todos	
R	93-97	MAZDA 626 Todos	
R	93-97	MX6 Todos	
G55675	C		141309
R	95-02	LEXUS ES300 Todos Izquierdo Exc. Suspensión Adaptable Variable	
R	92-94	ES300 Todos Izquierdo Struts Sellados de EO	
R	95-03	TOYOTA AVALON Todos Izquierdo	
R	95-01	CAMRY Todos Izquierdo	
R	92-94	CAMRY Todos Izquierdo Struts Sellados de EO	

Struts Ultra

Amort.	POP	No. Alternativo	Montaje Accesorio
Pos.	Año	Aplicación	
G55675	C	-continued	141309
R	99-03	SOLARA Todos Izquierdo	
G55676	C		141309
R	95-02	LEXUS ES300 Todos Derecho Exc. Suspensión Adaptable Variable	
R	92-94	ES300 Todos Derecho Struts Sellados de EO	
R	95-03	TOYOTA AVALON Todos Derecho	
R	95-01	CAMRY Todos Derecho	
R	92-94	CAMRY Todos Derecho Struts Sellados de EO	
R	99-03	SOLARA Todos Derecho	
G55679	B		141683
F	95-99	DODGE NEON Todos	
F	95-99	PLYMOUTH NEON Todos	
G55680	B		141683
R	95-99	DODGE NEON Todos	
R	95-99	PLYMOUTH NEON Todos	
G55681	C		141683
F	03-04	FORD MUSTANG / MUSTANG II Mach I	
F	94-04	MUSTANG / MUSTANG II Base	
F	94-04	MUSTANG / MUSTANG II GT	
F	04	MUSTANG / MUSTANG II GT Base	
F	04	MUSTANG / MUSTANG II GT Equipado	
F	01	MUSTANG / MUSTANG II GT Bullitt	
F	95	MUSTANG / MUSTANG II GTS	
G55685	A		141309
F	94-03	FORD WINDSTAR	
F	95-03	WINDSTAR Todos	
G55692	C		141682
F	95-97	FORD CONTOUR Todos Fab. hasta 3/97	
F	95-97	MERCURY MYSTIQUE Todos Fab. hasta 3/97	
G55693	C		141682
R	95-00	FORD CONTOUR Todos	
R	99-02	MERCURY COUGAR Todos	
R	95-00	MYSTIQUE Todos	
G55697	A		143004
F	96-00	CHRYSLER TOWN & COUNTRY Todos	
F	00	VOYAGER / GRAND VOYAGER Todos	
F	00	VOYAGER / GRAND VOYAGER Non-ABS	
F	96-00	DODGE CARAVAN / GRAND CARAVAN Todos Exc. Sistema de Autonivelación NIVOMAT	
F	96-00	PLYMOUTH VOYAGER / GRAND VOYAGER Todos	
G55698	B		141323
F	95-05	CHEVROLET CAVALIER Todos	
F	95-05	PONTIAC SUNFIRE Todos	
G55705	D		141323
R	81-90	FORD ESCORT Todos	
R	84-88	EXP Todos	
R	82-83	EXP Todos Fab. hasta 2/83	
R	82-83	MERCURY LN7 Todos	
R	81-87	LYNX Todos	
G55706	W		141682
F	80-83	HONDA CIVIC Todos	
G55707	W		141505
R	81-83	HONDA CIVIC Sedan	
R	80-83	CIVIC Hatchback	
G55710	W		141323
F	86-89	MAZDA 323 4x2 Tracción delantera Exc. Suspensión Electrónica Ajustable	
F	84-85	GLC Todos	
F	81-83	GLC Sedan	
F	81-82	GLC Hatchback	
F	87-89	MERCURY TRACER 4x2 Tracción delantera	
G55712	W		141120
F	83-85	FORD ESCORT Todos Fab. desde 2/83 hasta 2/85	
F	83-85	EXP Todos Fab. desde 2/83 hasta 3/85	
F	83	MERCURY LN7 Todos Fab. desde 2/83	

Lista numérica

Amort.	POP	No. Alternativo	Montaje Accesorio
Pos.	Año	Aplicación	
G55712	W	-continued	141120
F	83-85	LYNX Todos Fab. desde 2/83 hasta 3/85	
G55713	D		141310
F	86	NISSAN PULSAR / PULSAR NX Todos Fab. hasta 1/86	
F	83-85	PULSAR / PULSAR NX Todos	
F	82-86	SENTRA Todos	
F	84-87	TSURU	
G55714	C		142449
F	85-90	FORD ESCORT Todos Fab. desde 3/85	
F	85-88	EXP Todos Fab. desde 3/85	
F	84-94	GHIA	
F	87-94	TEMPO Todos	
F	85-86	TEMPO 4x2 Tracción delantera Fab. desde 3/85	
F	86-94	TOPAZ	
F	85-87	MERCURY LYNX Todos Fab. desde 3/85	
F	92-94	TOPAZ 4x2 Tracción delantera Fab. desde 3/85	
F	87-91	TOPAZ Todos Fab. desde 3/85	
F	85-86	TOPAZ 4x2 Tracción delantera Fab. desde 3/85	
G55715	D		142024
F	85-88	CHEVROLET NOVA Todos	
F	86-87	TOYOTA COROLLA 4x2 Tracción delantera Struts Delanteros Sellados	
F	84-85	COROLLA 4x2 Tracción delantera, GAS Struts Delanteros Sellados	
G55719	W		141682
F	85-88	CHEVROLET SPECTRUM Todos	
F	89	GEO SPECTRUM Todos	
F	85-89	ISUZU I-MARK Todos	
F	85-88	PONTIAC SUNBURST Todos	
G55722	X		141323
R	87-91	FORD TEMPO AWD	
R	87-91	MERCURY TOPAZ AWD	
G55724	X		141682
F	83-84	SUBARU DL 4x2 Tracción delantera	
F	85-89	GL Hatchback, 4x2 Tracción delantera	
F	83-84	GL 4x2 Tracción delantera	
G55725	D		141682
F	84-87	HONDA CIVIC Hatchback	
F	84-87	CIVIC Sedan	
G55726	W		141701
F	82-87	SUBARU BRAT Todos	
F	82-84	DL 4x4	
F	85-89	GL Hatchback, 4x4	
F	82-84	GL 4x4	
G55727	D		141982
F	83-87	MAZDA 626 Todos Exc. Suspensión Electrónica Ajustable	
G55728	W		141682
F	85-87	HONDA CIVIC Wagon, 4x4	
G55729	X		141309
R	83-87	MAZDA 626 Todos Exc. Suspensión Electrónica Ajustable	
G55731	D		141682
F	86-89	ACURA INTEGRA Todos	
G55732	W		141682
F	84-87	HONDA CIVIC Wagon, 4x2 Tracción delantera	
G55733	C		141323
R	84-94	FORD GHIA	
R	84-94	TEMPO 4x2 Tracción delantera	
R	86-94	TOPAZ	
R	84-94	MERCURY TOPAZ 4x2 Tracción delantera	
G55742	D		141544
F	86-89	HONDA ACCORD Todos	
F	88-91	PRELUDE Todos	
G55743	W		141544
R	86-89	HONDA ACCORD Todos	
G55745	C		141709
F	88-91	NISSAN HIKARI	
F	91-93	NX Todos	
F	87-90	PULSAR / PULSAR NX Todos	

Lista numérica

Amort.	POP	No. Alternativo	Montaje Accesorio
Pos.	Año	Aplicación	
G55745	C	-continued	141709
F 86		PULSAR / PULSAR NX Todos desde 1/86	
F 91-92		SENTRA Non-ABS	
F 87-90		SENTRA 4x2 Tracción delantera	
F 88-91		TSURU	
G55746	C		141682
R 88-91		NISSAN HIKARI	
R 87-90		PULSAR / PULSAR NX Todos	
R 86		PULSAR / PULSAR NX Todos desde 1/86	
R 87-92		SENTRA 4x2 Tracción delantera	
R 88-91		TSURU	
G55749	D		141682
F 85-88		CHEVROLET SPRINT Todos	
F 85-88		PONTIAC FIREFLY Todos	
F 85-88		SUZUKI FORSA Todos	
G55752	D		141689
R 85-88		CHEVROLET NOVA Todos	
R 86-87		TOYOTA COROLLA 4x2 Tracción delantera	
R 84-85		COROLLA 4x2 Tracción delantera, GAS	
R 87		TERCEL Wagon, 4x2 Tracción delantera	
R 83-86		TERCEL Todos	
G55757	D		141699
R 88-91		HONDA PRELUDE Todos	
G55763	W		141720
F 88		HONDA CIVIC Hatchback	
F 88		CIVIC Sedan	
F 88		CRX Todos	
G55766	D		141716
R 88		HONDA CIVIC Hatchback	
R 88		CIVIC Sedan	
R 88		CRX Todos	
G55770	W		141544
F 89-90		ACURA LEGEND Todos Exc. Sistema de Autonivelación	
F 87-88		LEGEND Coupe	
G55771	D		143427
R 89-91		HONDA CIVIC Hatchback	
R 89-91		CIVIC Sedan	
G55772	D		141682
R 98-01		CHEVROLET METRO Non-ABS	
R 89-91		SPRINT Todos	
R 89-97		GEO METRO Non-ABS	
R 95-99		PONTIAC FIREFLY Non-ABS	
R 94		FIREFLY Todos	
R 89-91		FIREFLY Todos	
R 89-01		SUZUKI SWIFT Todos	
G55773	D		141544
F 89-91		HONDA CIVIC Hatchback	
F 89-91		CIVIC Sedan	
G55774	D		141544
F 90-93		HONDA ACCORD Todos	
G55776	W		141682
R 93		ASUNA SUNFIRE Todos Exc. Suspensión Lotus	
R 90-93		GEO STORM Non-ABS	
R 90-92		ISUZU IMPULSE 4x2 Tracción delantera	
R 91-93		STYLUS Todos	
G55780	D		142116
F 93		ASUNA SUNFIRE Todos	
F 90-93		GEO STORM Non-ABS	
F 90-92		ISUZU IMPULSE Todos	
F 91-93		STYLUS Todos	
G55781	W		141544
F 89-91		HONDA CIVIC Wagon	
G55782	W		141544
R 89-91		HONDA CIVIC Wagon	
G55784	X		141682
F 87-89		SUBARU DL Coupe, 4x4 Derecho Exc. Suspensión de Aire	
F 87-89		DL Wagon, 4x4 Derecho Exc. Suspensión de Aire	
F 87-89		GL Coupe, 4x4 Derecho Exc. Suspensión de Aire	
F 87-89		GL Wagon, 4x4 Derecho Exc. Suspensión de Aire	

Struts Ultra

Amort.	POP	No. Alternativo	Montaje Accesorio
Pos.	Año	Aplicación	
G55784	X	-continued	141682
F 90-93		LOYALE 4x4 Derecho Exc. Suspensión de Aire	
G55785	X		141682
F 87-89		SUBARU DL Coupe, 4x4 Izquierdo Exc. Suspensión de Aire	
F 87-89		DL Wagon, 4x4 Izquierdo Exc. Suspensión de Aire	
F 87-89		GL Coupe, 4x4 Izquierdo Exc. Suspensión de Aire	
F 87-89		GL Wagon, 4x4 Izquierdo Exc. Suspensión de Aire	
F 90-93		LOYALE 4x4 Izquierdo Exc. Suspensión de Aire	
G55786	D		141544
R 97-99		ACURA CL Todos	
R 90-97		HONDA ACCORD Todos	
G55787	W		141544
F 90-93		ACURA INTEGRA Todos	
F 89-91		HONDA CRX Todos	
G55788	W		141544
R 90-93		ACURA INTEGRA Todos	
G55795	W		141544
F 92-96		HONDA PRELUDE Todos	
G55800	D		142126
R 91-02		SATURN SC / SL / SW SERIES Todos	
G55801	C		142127
F 91-02		SATURN SC / SL / SW SERIES Todos	
G55802	D		141544
F 97-01		ACURA INTEGRA GS	
F 97-01		INTEGRA GS Upper Mount orientation may be required	
F 94-01		INTEGRA GS-R	
F 94-01		INTEGRA GS-R Upper Mount orientation may be required	
F 94-01		INTEGRA LS	
F 94-01		INTEGRA LS Upper Mount orientation may be required	
F 95-96		INTEGRA Special Edition	
F 95-96		INTEGRA Special Edition Upper Mount orientation may be required	
F 92-95		HONDA CIVIC Todos	
F 92-95		CIVIC Todos Upper Mount orientation may be required	
F 93-97		CIVIC DEL SOL Todos	
F 93-97		CIVIC DEL SOL Todos Upper Mount orientation may be required	
G55803	D		142128
R 97-01		ACURA INTEGRA GS	
R 94-01		INTEGRA GS-R	
R 94-01		INTEGRA LS	
R 95-96		INTEGRA Special Edition	
R 92-95		HONDA CIVIC Todos	
R 93-97		CIVIC DEL SOL Todos	
R 89-91		CRX Todos	
G55804	D		142099
R 92-94		TOYOTA PASEO Todos	
R 91-94		TERCEL Todos	
G55805	W		142128
R 92-01		HONDA PRELUDE Todos	
G55817	D		141572
R 95-96		CHEVROLET LUMINA Todos	
R 95-96		MONTE CARLO Todos	
G55818	C		142154
F 95-96		CHRYSLER CIRRUS Todos	
F 96		SEBRING Convertible	
F 95-96		DODGE STRATUS Todos	
F 96		PLYMOUTH BREEZE Todos	
G55819	D		142094
F 95-98		EAGLE TALON Todos	
F 95-99		MITSUBISHI ECLIPSE Todos	
G55820	W		142094
F 95-00		CHRYSLER SEBRING Coupe	
F 95-00		DODGE AVENGER Todos	
F 94-98		MITSUBISHI GALANT Todos	
G55821	W		142372
R 95-98		HONDA ODYSSEY Todos	
R 96-99		ISUZU OASIS Todos	

Lista numérica

Amort.	POP	No. Alternativo	Montaje Accesorio
Pos.	Año	Aplicación	
G55825	B		142609
R 95-05		CHEVROLET CAVALIER Todos	
R 95-05		PONTIAC SUNFIRE Todos	
G55828	C		142780
F 92-94		TOYOTA PASEO Todos	
F 91-94		TERCEL Todos	
G55831	D		141683
R 97-01		CHEVROLET LUMINA Todos	
R 97-99		MONTE CARLO Todos	
G55832	C		142081
F 98-01		NISSAN ALTIMA Todos Izquierdo	
G55833	C		142081
F 98-01		NISSAN ALTIMA Todos Derecho	
G55834	D		142169
F 02-07		BUICK RENDEZVOUS Todos Exc. Sistema de Autonivelación NIVOMAT	
F 01-05		PONTIAC AZTEK Todos	
G55847	C		141682
F 91-96		FORD ESCORT Todos	
F 90-94		MAZDA 323 Todos	
F 92-95		MX-3 Non-ABS	
F 90-94		PROTÉGÉ / PROTÉGÉ5 4x2 Tracción delantera, Non-ABS	
F 91-96		MERCURY TRACER 4x2 Tracción delantera	
G55848	C		
R 91-03		FORD ESCORT Todos	
R 90-94		MAZDA 323 Todos	
R 92-95		MX-3 Non-ABS	
R 90-94		PROTÉGÉ / PROTÉGÉ5 4x2 Tracción delantera, Non-ABS	
R 91-99		MERCURY TRACER 4x2 Tracción delantera	
G55849	D		
F 95-99		HYUNDAI ACCENT Todos	
G55850	D		
R 97		HYUNDAI ACCENT Todos Fab. hasta 6/97	
R 95-96		ACCENT Todos	
G55856	D		142169
R 99-04		CHRYSLER 300M Todos	
R 98-04		CONCORDE Todos	
R 98-04		INTREPID Todos	
R 99-01		LHS Todos	
R 98-04		DODGE INTREPID Todos	
G55857	W		141682
F 96-99		SUBARU LEGACY Brighton, AWD Derecho	
F 96-99		LEGACY GT, AWD Derecho	
F 95-99		LEGACY L, AWD Derecho	
F 95-98		LEGACY Postal, AWD Derecho	
F 98		LEGACY GT Limited, AWD Derecho	
F 95-97		LEGACY LSi, AWD Derecho	
F 95-96		LEGACY LS, AWD Derecho	
G55858	W		141682
F 96-99		SUBARU LEGACY Brighton, AWD Izquierdo	
F 96-99		LEGACY GT, AWD Izquierdo	
F 95-99		LEGACY L, AWD Izquierdo	
F 95-98		LEGACY Postal, AWD Izquierdo	
F 98		LEGACY GT Limited, AWD Izquierdo	
F 95-97		LEGACY LSi, AWD Izquierdo	
F 95-96		LEGACY LS, AWD Izquierdo	
G55859	D		141682
R 95-99		SUBARU LEGACY Brighton, AWD Derecho	
G55860	D		141682
R 95-99		SUBARU LEGACY Brighton, AWD Izquierdo	
G55865	W		141682
F 95-99		SUBARU LEGACY Outback Derecho	
F 99		LEGACY Outback Limited Derecho	
F 97		LEGACY Outback Limited Derecho	
G55866	W		141682
F 95-99		SUBARU LEGACY Outback Izquierdo	
F 99		LEGACY Outback Limited Izquierdo	
F 97		LEGACY Outback Limited Izquierdo	

Lista numérica

Amort.	POP	No. Alternativo	Montaje Accesorio
Pos.	Año	Aplicación	
G55867	W		
R 95-99	SUBARU	LEGACY Outback Derecho	
R 99		LEGACY Outback Limited Derecho	
R 97		LEGACY Outback Limited Derecho	
G55868	W		
R 95-99	SUBARU	LEGACY Outback Izquierdo	
R 99		LEGACY Outback Limited Izquierdo	
R 97		LEGACY Outback Limited Izquierdo	
G55870	C		141544
F 01-03	ACURA	CL Todos	
F 99-03		TL Todos	
F 98-02	HONDA	ACCORD Todos	
G55871	C		141544
R 01-03	ACURA	CL Todos	
R 99-03		TL Todos	
R 98-02	HONDA	ACCORD Todos	
G55877	D		141544
F 97-99	ACURA	CL Todos	
F 94-97	HONDA	ACCORD Todos	
F 95-98	ODYSSEY	Todos	
F 96-99	ISUZU	OASIS Todos	
G55878	W		141683
F 97	BUICK	PARK AVENUE Todos	
F 97		RIVIERA Todos	
F 97		OLDSMOBILE AURORA Todos	
G55879	D		142780
F 95-99	TOYOTA	PASEO Todos	
F 95-99		TERCEL Todos	
G55881	D		141682
F 95-98	MAZDA	PROTÉGÉ / PROTÉGÉ5 Todos Derecho	
G55882	D		141682
F 95-98	MAZDA	PROTÉGÉ / PROTÉGÉ5 Todos Izquierdo	
G55883	D		141682
R 95-98	MAZDA	PROTÉGÉ / PROTÉGÉ5 Todos Derecho	
G55884	D		141682
R 95-98	MAZDA	PROTÉGÉ / PROTÉGÉ5 Todos Izquierdo	
G55890	D		
R 98-99	HYUNDAI	ACCENT Todos Non Gas Charged Unit	
R 97		ACCENT Todos Fab. desde 6/97; Non Gas Charged Unit	
G55891	D		141682
F 98-01	CHEVROLET	METRO Non-ABS	
F 89-91		SPRINT Todos	
F 89-97	GEO	METRO Non-ABS	
F 95-99	PONTIAC	FIREFLY Non-ABS	
F 94		FIREFLY Todos	
F 89-91		FIREFLY Todos	
F 89-01	SUZUKI	SWIFT Todos	
G55892	B		
F 00-02	CHRYSLER	NEON Todos	
F 03-05	DODGE	NEON SXT	
F 00-05		NEON SE	
F 01-04		NEON R/T	
F 00-03		NEON LE	
F 01-02		NEON ACR	
F 01-02		NEON Base	
F 00-02		NEON ES	
F 00-02		NEON LX	
F 00		NEON High Line	
F 00-01	PLYMOUTH	NEON Todos	
G55893	C		
R 00-02	CHRYSLER	NEON Todos Derecho	
R 03-05	DODGE	NEON SXT Derecho	
R 00-05		NEON SE Derecho	
R 01-04		NEON R/T Derecho	
R 00-03		NEON LE Derecho	
R 01-02		NEON ACR Derecho	
R 01-02		NEON Base Derecho	
R 00-02		NEON ES Derecho	
R 00-02		NEON LX Derecho	
R 00		NEON High Line Derecho	
R 00-01	PLYMOUTH	NEON Todos Derecho	
G55894	C		142098
R 00-02	CHRYSLER	NEON Todos Izquierdo	
R 03-05	DODGE	NEON SE Izquierdo	

Struts Ultra

Amort.	POP	No. Alternativo	Montaje Accesorio
Pos.	Año	Aplicación	
G55894	C	-continued	142098
R 03-05	NEON	SXT Izquierdo	
R 01-04	NEON	R/T Izquierdo	
R 00-03	NEON	LE Izquierdo	
R 01-02	NEON	ACR Izquierdo	
R 01-02	NEON	Base Izquierdo	
R 00-02	NEON	ES Izquierdo	
R 00-02	NEON	LX Izquierdo	
R 00-01	PLYMOUTH	NEON Todos Izquierdo	
G55896	C		
F 01-10	CHRYSLER	PT CRUISER Todos	
G55901	C		142169
R 02-05	FORD	SABLE	
R 94		SABLE	
R 95-01		SABLE Todos	
R 94-07	TAURUS	Sedan	
R 94-05	MERCURY	SABLE Sedan	
G55903	D		141682
F 89-94	NISSAN	240SX Todos Izquierdo Exc. Suspensión Activa	
G55904	D		141682
F 89-94	NISSAN	240SX Todos Derecho Exc. Suspensión Activa	
G55909	C		141544
F 97-00	ACURA	EL Todos	
F 96-00	HONDA	CIVIC Todos	
G55910	C		141544
R 97-00	ACURA	EL Todos	
R 96-00	HONDA	CIVIC Todos	
G55911	D		142462
F 93-95	DODGE	COLT Todos	
F 93-96	EAGLE	SUMMIT Coupe	
F 93-96		SUMMIT Sedan	
F 96	MITSUBISHI	MIRAGE Todos Fab. hasta 5/96	
F 93-95		MIRAGE Todos	
F 93-94	PLYMOUTH	COLT Sedan	
G55912	D		142081
F 96-99	INFINITI	I30 Todos Derecho	
F 95-99	NISSAN	MAXIMA Todos Derecho	
G55913	D		142081
F 96-99	INFINITI	I30 Todos Izquierdo	
F 95-99	NISSAN	MAXIMA Todos Izquierdo	
G55914	D		142215
F 92-94	LEXUS	ES300 Todos Struts Sellados de EO	
F 92-94	TOYOTA	CAMRY Todos Struts Sellados de EO	
G55920	C		142081
F 93-98	MERCURY	VILLAGER Todos Izquierdo	
F 93-98	NISSAN	QUEST Todos Izquierdo	
G55921	C		142081
F 93-98	MERCURY	VILLAGER Todos Derecho	
F 93-98	NISSAN	QUEST Todos Derecho	
G55923	X		141309
F 90-91	SUBARU	LEGACY Coil (FrontSpringType) Derecho	
G55924	X		141309
F 90-91	SUBARU	LEGACY Coil (FrontSpringType) Izquierdo	
G55925	D		141309
F 93-01	SUBARU	IMPREZA Non-ABS Derecho	
F 92-94		LEGACY Coil (RearSpringType) Derecho	
G55926	D		141309
F 93-01	SUBARU	IMPREZA Non-ABS Izquierdo	
F 92-94		LEGACY Coil (RearSpringType) Izquierdo	
G55927	X		141309
R 91	SUBARU	LEGACY AWD, Coil (RearSpringType) Derecho Suspensión de Aire	
R 90		LEGACY AWD Derecho Exc. Suspensión de Aire	
G55928	X		141309
R 91	SUBARU	LEGACY AWD, Coil (RearSpringType) Izquierdo	

Lista numérica

Amort.	POP	No. Alternativo	Montaje Accesorio
Pos.	Año	Aplicación	
G55928	X	-continued	141309
R 90		LEGACY AWD Izquierdo Exc. Suspensión de Aire	
G55929	W		141309
R 95-01	SUBARU	IMPREZA L, AWD, Non-ABS Derecho	
R 96-97		IMPREZA Brighton, AWD, Non-ABS Derecho	
R 95		IMPREZA Base, AWD, Non-ABS Derecho	
R 93-94		IMPREZA AWD, Non-ABS Derecho	
R 92-94		LEGACY AWD, Coil (RearSpringType) Derecho	
G55930	W		141309
R 95-01	SUBARU	IMPREZA L, AWD, Non-ABS Izquierdo	
R 96-97		IMPREZA Brighton, AWD, Non-ABS Izquierdo	
R 95		IMPREZA Base, AWD, Non-ABS Izquierdo	
R 93-94		IMPREZA AWD, Non-ABS Izquierdo	
R 92-94		LEGACY AWD, Coil (RearSpringType) Izquierdo	
G55932	X		141309
R 90-91	SUBARU	LEGACY 4x2 Tracción delantera, Coil (RearSpringType) Izquierdo	
G55933	W		141309
R 93-95	SUBARU	IMPREZA 4x2 Tracción delantera, Non-ABS Derecho	
R 92-94		LEGACY 4x2 Tracción delantera, Coil (RearSpringType) Derecho	
G55934	W		
R 93-95	SUBARU	IMPREZA 4x2 Tracción delantera, Non-ABS Izquierdo	
R 92-94		LEGACY 4x2 Tracción delantera, Coil (RearSpringType) Izquierdo	
G55945	W		142174
F 89-90	DODGE	2000 GTX Todos	
F 91-93	EAGLE	2000 GTX Todos	
F 92-95	MITSUBISHI	EXPO Todos	
G55948	B		142169
F 05-09	BUICK	ALLURE Todos	
F 97-05		CENTURY Todos	
F 05-09		LACROSSE Todos	
F 97-04		REGAL Todos	
F 05-06		TERRAZA AWD	
F 00-16	CHEVROLET	IMPALA Todos	
F 00-07		MONTE CARLO Todos	
F 02-05		VENTURE Todos	
F 97-01		VENTURE 4x2 Tracción delantera	
F 98-02	OLDSMOBILE	INTRIGUE Todos	
F 97-04		SILHOUETTE Todos	
F 97-03	PONTIAC	GRAND PRIX Todos	
F 99-05		MONTANA Base	
F 97-98		TRANS SPORT Todos	
G55949	C		142169
R 05-09	BUICK	ALLURE Todos Exc. Modelos c/ Ruedas de 17" o 18"	
R 97-05		CENTURY Todos	
R 05-09		LACROSSE Todos Exc. Modelos c/ Ruedas de 17" o 18"	
R 97-04		REGAL Todos Exc. Modelos c/ Ruedas de 17" o 18"	
R 12-16	CHEVROLET	IMPALA Todos	
R 00-11		IMPALA Todos Exc. Modelos c/ Ruedas de 17" o 18"	
R 00-07		MONTE CARLO Todos Exc. Modelos c/ Ruedas de 17" o 18"	
R 98-02	OLDSMOBILE	INTRIGUE Todos Exc. Modelos c/ Ruedas de 17" o 18"	
R 97-08	PONTIAC	GRAND PRIX Todos Exc. Modelos c/ Ruedas de 17" o 18"	
G55951	W		142723
F 91-95	ACURA	LEGEND Todos Derecho	
G55952	W		141716
R 91-95	ACURA	LEGEND Todos	
G55958	W		142723
F 91-95	ACURA	LEGEND Todos Izquierdo	
G55960	C		142169
F 02-05	FORD	SABLE	
F 96-01		SABLE Todos Derecho	
F 96-07	TAURUS	Todos Derecho	
F 96-05	MERCURY	SABLE Todos Derecho	

Lista numérica

Amort.	POP	No. Alternativo	Montaje Accesorio
Pos.	Año	Aplicación	
G55970	B		141682
F	95-98	NISSAN 200SX Todos Izquierdo Eje Trasero Rígido B14	
F	95	LUCINO	
F	96-00	LUCINO Todos Izquierdo	
F	95-00	SENTRA Todos Izquierdo Eje Trasero Rígido B14	
G55971	B		141682
F	95-98	NISSAN 200SX Todos Derecho Eje Trasero Rígido B14	
F	95	LUCINO	
F	96-00	LUCINO Todos Derecho	
F	95-00	SENTRA Todos Derecho Eje Trasero Rígido B14	
G55974	C		142169
F	04-05	CHEVROLET CLASSIC Todos	
F	97-03	MALIBU Todos	
F	99-04	OLDSMOBILE ALERO Todos	
F	99	CUTLASS / CUTLASS SUPREME Todos	
F	98	CUTLASS / CUTLASS SUPREME Todos Struts Traseros con orificios en Montaje Inferior separados a 2.4" y 3.2"	
F	97	CUTLASS / CUTLASS SUPREME Todos	
F	99-05	PONTIAC GRAND AM Todos	
G55975	D		142169
R	97-98	CHEVROLET MALIBU Todos Struts Traseros con orificios en Montaje Inferior separados a 3.2"	
R	97-98	OLDSMOBILE CUTLASS / CUTLASS SUPREME Todos Diseño Inicial c/ Struts Traseros c/ orificios en Montaje Inferior separados 3.2"	
G55976	A		142076
R	91-93	NISSAN NX Todos Derecho	
R	91-94	SENTRA Non-ABS Derecho Suspensión Trasera Independiente B13	
R	92-18	TSURU	
G55977	A		142076
R	91-93	NISSAN NX Todos Izquierdo	
R	91-94	SENTRA Non-ABS Izquierdo Suspensión Trasera Independiente B13	
R	92-18	TSURU	
G55978	C		142169
F	02-05	FORD SABLE	
F	96-01	SABLE Todos Izquierdo	
F	96-07	TAURUS Todos Izquierdo	
F	96-05	MERCURY SABLE Todos Izquierdo	
G55989	D		
F	95-02	VOLKSWAGEN CABRIO Todos	
F	92-94	CORRADO VR6	
F	92-99	GOLF	
F	96-98	GTI	
F	96-98	JETTA A3 (Código plataforma del fabricante) VR6	
G55990	D		
F	92-95	VOLKSWAGEN GOLF	
F	92-95	GTI	
F	85-95	JETTA	
G55991	B		
F	93-98	VOLKSWAGEN GOLF	
F	93-98	JETTA	
G55992	D		141296
F	90-96	CHEVROLET LUMINA APV Todos	
F	90-96	OLDSMOBILE SILHOUETTE Todos	
F	90-96	PONTIAC TRANS SPORT Todos	
G55993	D		
F	98-03	TOYOTA SIENNA Todos Izquierdo	
G55994	D		
F	98-03	TOYOTA SIENNA Todos Derecho	
G55999	B		141309
F	98-02	CHEVROLET PRIZM Todos	
F	93-97	GEO PRIZM Todos	
F	93-02	TOYOTA COROLLA Todos	
G56501	C		142169
R	04-05	CHEVROLET CLASSIC Todos	
R	98-03	MALIBU Todos Struts Traseros con orificios en Montaje Inferior separados a 2.4"	

Struts Ultra

Amort.	POP	No. Alternativo	Montaje Accesorio
Pos.	Año	Aplicación	
G56501	C	-continued	142169
R	99-04	OLDSMOBILE ALERO Todos	
R	99	CUTLASS / CUTLASS SUPREME Todos	
R	98	CUTLASS / CUTLASS SUPREME Todos Segundo Diseño c/ Struts Traseros con orificios en Montaje Inferior separados 2.4"	
R	99-05	PONTIAC GRAND AM Todos	
G56502	D		
F	95-96	LEXUS ES300 Todos	
F	95-96	TOYOTA AVALON Todos	
F	95-96	CAMRY Todos	
G56503	D		141683
F	80-86	FORD THUNDERBIRD Todos	
F	83-86	MERCURY COUGAR Todos	
F	80-82	COUGAR XR-7	
G56504	D		141306
F	78-83	FORD FAIRMONT Todos	
F	81-82	GRANADA Todos	
F	83-86	LTD / COUNTRY SEDAN / COUNTRY SQUIRE / CROWN VICTORIA Todos	
F	84-93	MUSTANG / MUSTANG II LX, 2.3L 4Cyl L (140)	
F	84-86	MUSTANG / MUSTANG II LX, 5.0L 8Cyl V (302)	
F	82-83	MUSTANG / MUSTANG II 5.0L 8Cyl V (302)	
F	79-83	MUSTANG / MUSTANG II 2.3L 4Cyl L (140)	
F	80	MUSTANG / MUSTANG II 4.2L 8Cyl V (255)	
F	79	MUSTANG / MUSTANG II 5.0L 8Cyl V (302)	
F	87-88	THUNDERBIRD Naturally Aspirated (Eng Asp), Non-ABS	
F	79-86	MERCURY CAPRI Todos	
F	87-88	COUGAR Todos	
F	81-82	COUGAR Base	
F	82	COUGAR GS	
F	82	COUGAR LS	
F	83-86	MARQUIS Todos	
F	78-83	ZEPHYR Todos	
G56506	D		
F	97-01	LEXUS ES300 Todos Izquierdo Exc. Suspensión Adaptable Variable	
F	97-03	TOYOTA AVALON Todos Izquierdo	
F	97-01	CAMRY Todos Izquierdo	
F	99-03	SOLARA Todos Izquierdo	
G56508	D		141572
F	98-05	BUICK PARK AVENUE Todos	
F	98-99	RIVIERA Todos	
G56509	D		141572
F	00-05	BUICK LESABRE Todos	
F	00-05	CADILLAC DEVILLE Todos Exc. Suspensión Electrónica Ajustable	
F	98-04	SEVILLE Todos Exc. Suspensión Electrónica Ajustable	
F	01-03	OLDSMOBILE AURORA Todos	
F	98-99	AURORA Todos	
F	00-05	PONTIAC BONNEVILLE Todos	
G56512	W		
R	91-96	INFINITI G20 Todos Izquierdo	
G56513	W		
R	91-96	INFINITI G20 Todos Derecho	
G56514	D		
F	97-01	LEXUS ES300 Todos Derecho Exc. Suspensión Adaptable Variable	
F	97-03	TOYOTA AVALON Todos Derecho	
F	97-01	CAMRY Todos Derecho	
F	99-03	SOLARA Todos Derecho	
G56515	C		141682
F	01-02	FORD ESCORT SE Exc. Hot y Cool Coupe	
F	00-02	ESCORT ZX2 Exc. Hot y Cool Coupe	
F	00	ESCORT LX Exc. Hot y Cool Coupe	
F	00	ESCORT ZX2 S/R Exc. Hot y Cool Coupe	
F	98-99	ESCORT LX	
F	98-99	ESCORT SE	
F	98-99	ESCORT SE Equi	
F	98-99	ESCORT ZX2 Equi	
F	99	ESCORT ZX2 S/R	
F	99	ESCORT ZX2 Tipico	

Lista numérica

Amort.	POP	No. Alternativo	Montaje Accesorio
Pos.	Año	Aplicación	
G56515	C	-continued	141682
F	97	ESCORT Todos	
F	97-99	MERCURY TRACER 4x2 Tracción delantera	
G56516	B		
F	00-05	FORD FOCUS Todos Izquierdo	
G56517	B		141682
F	00-05	FORD FOCUS Todos Derecho	
G56518	C		141309
F	92-93	ASUNA SUNRUNNER Todos Sin ABS	
F	98-04	CHEVROLET TRACKER Non-ABS	
F	89-97	GEO TRACKER Non-ABS	
F	94-97	PONTIAC SUNRUNNER Todos Sin ABS	
F	99-05	SUZUKI GRAND VITARA Non-ABS	
F	89-98	SIDEKICK Non-ABS	
F	99-04	VITARA Non-ABS	
F	06	XL-7 Todos Sin ABS	
F	02-05	XL-7 Non-ABS	
G56520	C		141682
F	97-00	FORD CONTOUR Todos Fab. desde 3/97	
F	99-02	MERCURY COUGAR Todos	
F	97-00	MYSTIQUE Todos Fab. desde 3/97	
G56522	C		141682
F	00-05	HYUNDAI ACCENT Todos	
G56523	D		141682
R	00-05	HYUNDAI ACCENT Todos Derecho Non-Gas Charged Unit	
G56524	D		141682
R	00-05	HYUNDAI ACCENT Todos Izquierdo Non-Gas Charged Unit	
G56525	D		141682
F	00	HYUNDAI ELANTRA Todos Fab. hasta 5/00	
F	96-99	ELANTRA Todos	
F	97-01	TIBURON Todos	
G56526	D		141682
F	00	HYUNDAI ELANTRA Todos Izquierdo Fab. hasta 5/00	
F	96-99	ELANTRA Todos Izquierdo	
F	97-01	TIBURON Todos Izquierdo	
G56527	D		
R	00	HYUNDAI ELANTRA Todos Derecho Fab. hasta 5/00; Non-Gas Charged Unit	
R	96-99	ELANTRA Todos Derecho Non-Gas Charged Unit	
R	97-01	TIBURON Todos Derecho Non-Gas Charged Unit	
G56528	D		141682
R	00	HYUNDAI ELANTRA Todos Izquierdo Fab. hasta 5/00; Non-Gas Charged Unit	
R	96-99	ELANTRA Todos Izquierdo Non-Gas Charged Unit	
R	97-01	TIBURON Todos Izquierdo Non-Gas Charged Unit	
G56529	D		141682
F	98-02	MITSUBISHI MIRAGE 1.8L 4Cyl L (112) Derecho Con Resorte de 6" o 7"	
F	97	MIRAGE 1.8L 4Cyl L (112) Derecho Fab. desde 4/97; con Resorte de 6" o 7"	
G56530	D		141682
F	98-02	MITSUBISHI MIRAGE 1.8L 4Cyl L (112) Izquierdo Con Resorte de 6" o 7"	
F	97	MIRAGE 1.8L 4Cyl L (112) Izquierdo Fab. desde 4/97; con Resorte de 6" o 7"	
G56531	W		142078
F	00-01	KIA SEPHIA Non-ABS Derecho Fab. hasta 6/01	
F	98-99	SEPHIA Non-ABS Derecho	
G56532	W		142078
F	00-01	KIA SEPHIA Non-ABS Izquierdo Fab. hasta 6/01	
F	98-99	SEPHIA Non-ABS Izquierdo	

Lista numérica

Amort.	POP	No. Alternativo	Montaje Accesorio
Pos.	Año	Aplicación	
G56533	W		
R	00-01	KIA SEPHIA Todos Derecho Fab. hasta 6/01	
R	98-99	SEPHIA Todos Derecho	
R	00-01	SPECTRA Todos Derecho Fab. hasta 6/01	
G56534	W		
R	00-01	KIA SEPHIA Todos Izquierdo Fab. hasta 6/01	
R	98-99	SEPHIA Todos Izquierdo	
R	00-01	SPECTRA Todos Izquierdo Fab. hasta 6/01	
G56535	D		141682
F	99-00	MAZDA PROTÉGÉ / PROTÉGÉ5 Todos Derecho Fab. hasta 10/00	
G56536	D		141682
F	99-00	MAZDA PROTÉGÉ / PROTÉGÉ5 Todos Izquierdo Fab. hasta 10/00	
G56537	D		141682
R	02-03	MAZDA PROTÉGÉ / PROTÉGÉ5 Todos Derecho	
R	02-03	PROTÉGÉ / PROTÉGÉ5 SE Derecho	
R	01-03	PROTÉGÉ / PROTÉGÉ5 ES Derecho	
R	01-03	PROTÉGÉ / PROTÉGÉ5 LX Derecho	
R	01-02	PROTÉGÉ / PROTÉGÉ5 DX Derecho	
R	99-00	PROTÉGÉ / PROTÉGÉ5 Todos Derecho	
G56538	D		141682
R	02-03	MAZDA PROTÉGÉ / PROTÉGÉ5 Todos Izquierdo	
R	02-03	PROTÉGÉ / PROTÉGÉ5 SE Izquierdo	
R	01-03	PROTÉGÉ / PROTÉGÉ5 DX Izquierdo	
R	01-03	PROTÉGÉ / PROTÉGÉ5 ES Izquierdo	
R	01-03	PROTÉGÉ / PROTÉGÉ5 LX Izquierdo	
R	99-00	PROTÉGÉ / PROTÉGÉ5 Todos Izquierdo	
G56539	D		
F	01-06	HYUNDAI ELANTRA Todos Izquierdo	
F	00	ELANTRA Todos Izquierdo Fab. desde 5/00	
G56540	D		
F	01-06	HYUNDAI ELANTRA Todos Derecho	
F	00	ELANTRA Todos Derecho Fab. desde 5/00	
G56541	W		141682
R	00-01	SUBARU IMPREZA Outback Derecho Sin ABS	
R	95-99	IMPREZA Outback, Non-ABS Derecho	
G56542	W		141682
R	00-01	SUBARU IMPREZA Outback Izquierdo Sin ABS	
R	95-99	IMPREZA Outback, Non-ABS Izquierdo	
G56543	D		141682
F	98-02	SUBARU FORESTER Todos Derecho	
G56544	D		141682
F	98-02	SUBARU FORESTER Todos Izquierdo	
G56545	D		
R	98-02	SUBARU FORESTER Todos Derecho Exc. Sistema de Autonivelación NIVOMAT	
G56546	D		
R	98-02	SUBARU FORESTER Todos Izquierdo Exc. Sistema de Autonivelación NIVOMAT	
G56547	W		141309
F	99-03	LEXUS RX300 Todos Derecho	
G56548	W		
F	99-03	LEXUS RX300 Todos Izquierdo	

Struts Ultra

Amort.	POP	No. Alternativo	Montaje Accesorio
Pos.	Año	Aplicación	
G56551	C		
F	01-05	CHRYSLER SEBRING ST (Código plataforma del fabricante), Coupe Derecho	
F	01-05	DODGE STRATUS ST (Código plataforma del fabricante), Coupe Derecho	
F	00-05	MITSUBISHI ECLIPSE Todos Derecho	
G56552	D		
F	01-05	CHRYSLER SEBRING ST (Código plataforma del fabricante), Coupe Izquierdo	
F	01-05	DODGE STRATUS ST (Código plataforma del fabricante), Coupe Izquierdo	
F	00-05	MITSUBISHI ECLIPSE Todos Izquierdo	
G56553	W		141309
R	99-03	LEXUS RX300 4x2 Tracción delantera Derecho	
G56554	W		141309
R	99-03	LEXUS RX300 4x2 Tracción delantera Izquierdo	
G56555	W		141682
F	00-04	SUBARU LEGACY Todos Derecho	
G56556	W		141682
F	00-04	SUBARU LEGACY Todos Izquierdo	
G56557	W		
R	00-04	SUBARU LEGACY Todos	
G56558	C		141682
F	99-04	HONDA ODYSSEY Todos Derecho	
G56559	C		141682
F	99-04	HONDA ODYSSEY Todos Izquierdo	
G56561	D		141682
F	01-06	HYUNDAI SANTA FE Todos Derecho	
G56562	D		141682
F	01-06	HYUNDAI SANTA FE Todos Izquierdo	
G56565	D		141716
F	99-00	HYUNDAI SONATA Todos	
G56566	W		141716
R	00	HYUNDAI SONATA Todos Fab. hasta 4/00	
R	99	SONATA Todos	
G56568	B		
F	01-12	FORD ESCAPE Todos Derecho	
F	08-11	MAZDA TRIBUTE Todos Derecho	
F	01-06	TRIBUTE Todos Derecho	
F	05-11	MERCURY MARINER Todos Derecho	
G56569	D		
F	94-97	KIA SEPHIA Todos Derecho	
G56570	W		
F	94-97	KIA SEPHIA Todos Izquierdo	
G56571	X		
R	94-97	KIA SEPHIA Todos Derecho	
G56572	D		141682
F	00-05	TOYOTA ECHO Todos	
F	03-05	YARIS	
G56573	D		
F	94-99	TOYOTA CELICA Todos Izquierdo	
G56574	D		
R	94-99	TOYOTA CELICA Todos Derecho	
G56575	D		
R	94-99	TOYOTA CELICA Todos Izquierdo	
G56576	D		
F	94-99	TOYOTA CELICA Todos Derecho	
G56577	W		141682
F	95-98	HYUNDAI SONATA Todos	
G56579	X		
R	95-96	SUBARU LEGACY L, 4x2 Tracción delantera Derecho	

Lista numérica

Amort.	POP	No. Alternativo	Montaje Accesorio
Pos.	Año	Aplicación	
G56581	D		141309
F	01-05	TOYOTA RAV4 Todos Derecho	
F	00	RAV4 Todos Derecho Fab. desde 5/00	
G56582	D		141309
F	01-05	TOYOTA RAV4 Todos Izquierdo	
F	00	RAV4 Todos Izquierdo Fab. desde 5/00	
G56585	D		
F	00-05	TOYOTA CELICA Todos Derecho	
G56586	D		
F	00-05	TOYOTA CELICA Todos Izquierdo	
G56587	D		
R	00-05	TOYOTA CELICA Todos	
G56588	D		141309
F	00	MAZDA MPV Todos Derecho Fab. hasta 8/00	
G56589	D		141309
F	00	MAZDA MPV Todos Izquierdo Fab. hasta 8/00	
G56591	W		
F	91-96	INFINITI G20 Todos	
G56592	W		
F	90-00	LEXUS LS400 Coil (RearSpringType)	
G56593	W		
R	90-94	LEXUS LS400 Coil (RearSpringType)	
G56594	W		141682
F	93-97	LEXUS GS300 Todos	
G56595	W		
R	93-97	LEXUS GS300 Todos	
G56596	W		
F	03-05	MAZDA MIATA Base	
F	03-05	MIATA LS	
F	03	MIATA SE	
F	99-02	MIATA Todos	
G56597	D		
R	03-05	MAZDA MIATA Base	
R	03-05	MIATA LS	
R	03	MIATA SE	
R	99-02	MIATA Todos	
G56598	W		
F	98-05	LEXUS GS300 Todos	
F	98-00	GS400 Todos	
F	01-05	GS430 Todos	
F	02-07	SC430 Todos	
G56599	W		141682
R	98-05	LEXUS GS300 Todos	
R	98-00	GS400 Todos	
R	01-05	GS430 Todos	
G56600	W		
R	95-00	LEXUS LS400 Coil (RearSpringType)	
G56601	B		
F	01-12	FORD ESCAPE Todos Izquierdo	
F	08-11	MAZDA TRIBUTE Todos Izquierdo	
F	01-06	TRIBUTE Todos Izquierdo	
F	05-11	MERCURY MARINER Todos Izquierdo	
G56602	W		
F	92-98	BMW 318i Todos Izquierdo	
F	92-98	318iS Todos Izquierdo	
F	95-99	318Ti Todos Izquierdo	
G56603	W		
F	92-98	BMW 318i Todos Derecho	
F	92-98	318iS Todos Derecho	
F	95-99	318Ti Todos Derecho	
G56604	D		
F	98-99	BMW 323i E36 (Código plataforma del fabricante) Izquierdo	
F	92-95	325i E36 (Código plataforma del fabricante) Izquierdo	
F	96-98	328i Todos Izquierdo	
G56605	D		
F	98-99	BMW 323i E36 (Código plataforma del fabricante) Derecho	

Lista numérica

Amort.	POP	No. Alternativo	Montaje Accesorio
Pos.	Año	Aplicación	
G56605	D	-continued	
F	92-95	325I E36 (Código plataforma del fabricante) Derecho	
F	96-98	328I Todos Derecho	
G56606	A		
F	96-97	AUDI A3	
F	96-99	A3 QUATTRO	
F	98-00	SEAT LEON	
F	01-07	LEON Todos	
F	98-00	TOLEDO	
F	01-06	TOLEDO Todos	
F	98-11	VOLKSWAGEN BEETLE Todos	
F	10-12	CLÁSICO	
F	99-11	GOLF	
F	99-11	GTI	
F	99-12	JETTA	
F	13-18	JETTA A4 (MFR BODY)	
G56607	W		
F	03	BMW 540I Todos Fab. hasta 10/03, Exc. Suspensión Electrónica Ajustable	
F	97-02	540I Todos Exc. Suspensión Electrónica Ajustable	
F	95	540I Todos Exc. Suspensión Electrónica Ajustable	
G56608	D		
F	01-03	BMW 525I Sedan Exc. Suspensión Electrónica Ajustable	
F	97-00	528I Sedan	
F	01-03	530I Todos Exc. Suspensión Electrónica Ajustable	
G56611	W		
F	00-06	AUDI TT Todos	
F	00-06	TT QUATTRO Todos	
G56612	W		
F	93-97	VOLVO 850 Todos Exc. Sistema de Autonivelación NIVOMAT	
F	98-04	C70 Todos	
F	98-00	S70 Todos	
F	98-00	V70 GLT Fab. hasta 3/00 y Exc. XC70, XC Cross Country	
F	00	V70 GLT SE Fab. hasta 3/00 y Exc. XC70, XC Cross Country	
F	98-99	V70 Base Fab. hasta 3/00 y Exc. XC70, XC Cross Country	
F	98-99	V70 T5 Fab. hasta 3/00 y Exc. XC70, XC Cross Country	
F	98	V70 R Fab. hasta 3/00 y Exc. XC70, XC Cross Country	
G56615	D	141682	
F	99-01	INFINITI QX4 Todos Izquierdo Fab. desde 12/98	
F	99-01	NISSAN PATHFINDER Todos Izquierdo With EO# 543034W985	
G56616	D	141682	
F	99-01	INFINITI QX4 Todos Derecho Fab. desde 12/98	
F	99-01	NISSAN PATHFINDER Todos Derecho With EO# 543034W985	
G56618	B	141682	
F	00-01	NISSAN SENTRA Todos Izquierdo	
G56619	B		
F	00-01	NISSAN SENTRA Todos Derecho	
G56620	A	143004	
F	01-07	CHRYSLER TOWN & COUNTRY Todos	
F	01-07	VOYAGER / GRAND VOYAGER Todos	
F	01-07	DODGE CARAVAN / GRAND CARAVAN Todos	
G56621	B	141682	
F	01-03	ACURA EL Todos Izquierdo	
F	03-05	HONDA CIVIC Hybrid Izquierdo	
F	02	CIVIC Coupe Izquierdo	
F	02	CIVIC Sedan Izquierdo	
F	01	CIVIC Todos Izquierdo	
G56622	B	141682	
F	01-03	ACURA EL Todos Derecho	
F	03-05	HONDA CIVIC Hybrid Derecho	
F	02	CIVIC Coupe Derecho	
F	02	CIVIC Sedan Derecho	
F	01	CIVIC Todos Derecho	
G56624	W		
F	01-06	MAZDA MPV Todos Derecho	

Struts Ultra

Amort.	POP	No. Alternativo	Montaje Accesorio
Pos.	Año	Aplicación	
G56624	W	-continued	
F	00	MPV Todos Derecho Fab. desde 8/00	
G56625	W		
F	01-06	MAZDA MPV Todos Izquierdo	
F	00	MPV Todos Izquierdo Fab. desde 8/00	
G56626	D		
F	95-02	SUZUKI ESTEEM Todos Derecho	
G56627	D		
F	95-02	SUZUKI ESTEEM Todos Izquierdo	
G56628	D		
R	95-02	SUZUKI ESTEEM Todos Derecho	
G56629	D		
R	95-02	SUZUKI ESTEEM Todos Izquierdo	
G56631	D	141309	
F	00	TOYOTA RAV4 Todos Izquierdo Struts Sellados fabricados en Abr/00	
F	96-99	RAV4 Todos Izquierdo Struts Sellados	
G56632	C	141309	
F	00	TOYOTA RAV4 Todos Derecho Struts Sellados fabricados en Abr/00	
F	96-99	RAV4 Todos Derecho Struts Sellados	
G56633	D	141682	
F	00-03	MAZDA PROTÉGÉ / PROTÉGÉ5 Todos Derecho Fab. desde 10/00	
G56634	D	141682	
F	00-03	MAZDA PROTÉGÉ / PROTÉGÉ5 Todos Izquierdo Fab. desde 10/00	
G56635	D		
F	99-03	MITSUBISHI GALANT Todos Derecho	
G56636	D	141682	
F	99-03	MITSUBISHI GALANT Todos Izquierdo	
G56637	X		
R	94-97	KIA SEPHIA Todos Izquierdo	
G56640	D	141682	
R	01-06	HYUNDAI ELANTRA Todos Izquierdo	
R	00	ELANTRA Todos Izquierdo Fab. desde 5/00	
G56641	D	141682	
R	01-06	HYUNDAI ELANTRA Todos Derecho	
R	00	ELANTRA Todos Derecho Fab. desde 5/00	
G56642	D	141682	
F	03-08	HYUNDAI TIBURON Todos Izquierdo	
G56643	D	141682	
F	03-08	HYUNDAI TIBURON Todos Derecho	
G56644	D	141682	
R	03-08	HYUNDAI TIBURON Todos Izquierdo	
G56645	D	141682	
R	03-08	HYUNDAI TIBURON Todos Derecho	
G56648	A		
F	02-10	NISSAN PLATINA	
F	02-08	RENAULT CLIO	
G56649	B		
F	00-08	CHEVROLET ASTRA Todos Izquierdo	
F	00-07	ZAFIRA	
G56650	B		
F	00-08	CHEVROLET ASTRA Todos Derecho	
F	00-07	ZAFIRA	
G56655	D	142098	
F	04-07	FORD FREESTAR Todos	
F	04-07	MERCURY MONTEREY Mini Passenger Van	

Lista numérica

Amort.	POP	No. Alternativo	Montaje Accesorio
Pos.	Año	Aplicación	
G56660	C		
F	03-08	TOYOTA COROLLA Todos Derecho	
G56661	C	141309	
F	03-08	TOYOTA COROLLA Todos Izquierdo	
G56664	D		
R	98-99	CADILLAC DEVILLE Todos Exc. Suspensión Electrónica Ajustable	
R	94-97	DEVILLE Air (RearSpringType) Exc. Suspensión Electrónica Ajustable	
G56667	W	141309	
R	01-03	TOYOTA HIGHLANDER 4x2 Tracción delantera Izquierdo	
G56668	W	141309	
R	01-03	TOYOTA HIGHLANDER 4x2 Tracción delantera Derecho	
G56669	D	141038	
F	94-95	CADILLAC DEVILLE Todos Izquierdo Exc. Suspensión Electrónica Ajustable	
G56670	D	141038	
F	94-95	CADILLAC DEVILLE Todos Derecho Exc. Suspensión Electrónica Ajustable	
G56671	B		
F	02-06	NISSAN ALTIMA Todos Izquierdo	
F	04-08	MAXIMA Todos Izquierdo	
G56672	B		
F	02-06	NISSAN ALTIMA Todos Derecho	
F	04-08	MAXIMA Todos Derecho	
G56673	D	141309	
F	02-03	LEXUS ES300 Todos Izquierdo Exc. Suspensión Adaptable Variable	
F	02-03	TOYOTA CAMRY Todos Izquierdo	
G56674	D	141309	
F	02-03	LEXUS ES300 Todos Derecho Exc. Suspensión Adaptable Variable	
F	02-03	TOYOTA CAMRY Todos Derecho	
G56675	D		
R	03	LEXUS ES300 Todos Izquierdo Exc. Suspensión Adaptable Variable	
R	02-03	TOYOTA CAMRY Todos Izquierdo	
G56676	D		
R	03	LEXUS ES300 Todos Derecho Exc. Suspensión Adaptable Variable	
R	02-03	TOYOTA CAMRY Todos Derecho	
G56677	D		
F	04-05	HONDA CIVIC Value Package, Coupe Izquierdo	
F	04-05	CIVIC Value Package, Sedan Izquierdo	
F	03-05	CIVIC DX, Sedan Izquierdo	
F	03-05	CIVIC EX, Coupe Izquierdo	
F	03-05	CIVIC EX, Sedan Izquierdo	
F	03-05	CIVIC GX, Sedan Izquierdo	
F	03-05	CIVIC HX, Coupe Izquierdo	
F	03-05	CIVIC LX, Coupe Izquierdo	
F	03-05	CIVIC LX, Sedan Izquierdo	
F	03-05	CIVIC Si, Coupe Izquierdo	
F	03-05	CIVIC Si, Sedan Izquierdo	
F	05	CIVIC EX Special Edition, Coupe Izquierdo	
F	05	CIVIC EX Special Edition, Sedan Izquierdo	
F	05	CIVIC LX Special Edition, Sedan Izquierdo	
F	03-04	CIVIC DX, Coupe Izquierdo	
G56678	C		
F	04-05	HONDA CIVIC Value Package, Coupe Derecho	
F	04-05	CIVIC Value Package, Sedan Derecho	
F	03-05	CIVIC DX, Sedan Derecho	
F	03-05	CIVIC EX, Coupe Derecho	
F	03-05	CIVIC EX, Sedan Derecho	
F	03-05	CIVIC GX, Sedan Derecho	
F	03-05	CIVIC HX, Coupe Derecho	
F	03-05	CIVIC LX, Coupe Derecho	
F	03-05	CIVIC LX, Sedan Derecho	
F	03-05	CIVIC Si, Coupe Derecho	
F	03-05	CIVIC Si, Sedan Derecho	
F	05	CIVIC EX Special Edition, Sedan Derecho	

Lista numérica

Amort.	POP	No. Alternativo	Montaje Accesorio
Pos.	Año	Aplicación	
G56678	C	-continued	141038
F	05	CIVIC LX Special Edition, Coupe Derecho	
F	05	CIVIC LX Special Edition, Sedan Derecho	
F	03-04	CIVIC DX, Coupe Derecho	
G56679	W		141038
F	01-03	TOYOTA HIGHLANDER Todos Izquierdo	
G56680	W		141038
F	01-03	TOYOTA HIGHLANDER Todos Derecho	
G56681	W		141038
R	99-03	LEXUS RX300 AWD Izquierdo	
R	01-03	TOYOTA HIGHLANDER AWD Izquierdo	
G56682	W		141038
R	99-03	LEXUS RX300 AWD Derecho	
R	01-03	TOYOTA HIGHLANDER AWD Derecho	
G56683	D		141682
F	00-01	INFINITI I30 Todos Izquierdo	
F	00-01	NISSAN MAXIMA Todos Izquierdo	
G56684	D		141682
F	00-01	INFINITI I30 Todos Derecho	
F	00-01	NISSAN MAXIMA Todos Derecho	
G56685	D		141682
F	02-04	INFINITI I35 Todos Izquierdo	
F	02-03	NISSAN MAXIMA Todos Izquierdo	
G56686	D		141682
F	02-04	INFINITI I35 Todos Derecho	
F	02-03	NISSAN MAXIMA Todos Derecho	
G56687	D		141682
F	02-03	INFINITI QX4 Todos Izquierdo	
F	01-04	NISSAN PATHFINDER Todos Izquierdo With EO# 543034W925 or 543034W926	
G56688	D		141682
F	02-03	INFINITI QX4 Todos Derecho	
F	01-04	NISSAN PATHFINDER Todos Derecho With EO# 543034W925 or 543034W926	
G56689	D		141156
F	98-02	MAZDA 626 Todos Izquierdo	
G56690	D		141156
F	98-02	MAZDA 626 Todos Derecho	
G56691	D		141156
R	98-02	MAZDA 626 Todos	
G56692	C		141156
F	01-07	FORD MONDEO	
G56693	D		141156
R	01-07	FORD MONDEO	
G56694	D		141156
F	01-04	RENAULT MEGANE	
F	01-04	SCENIC	
F	05-06	SCENIC II	
G56700	D		141038
F	82-92	CHEVROLET CAMARO Todos	
F	82-92	PONTIAC FIREBIRD Todos	
G56701	W		141038
F	85-90	BUICK ELECTRA Todos	
F	90	LESABRE Todos Strut Delantero de Diseño Inicial c/ Resorte de Seguridad	
F	86-89	LESABRE Todos	
F	85-90	CADILLAC COMMERCIAL CHASSIS Todos	
F	85-90	DEVILLE Todos	
F	85-90	FLEETWOOD Todos	
F	86-90	OLDSMOBILE 88 SERIES Todos Strut Delantero de Diseño Inicial c/ Resorte de Seguridad	
F	85-90	98 Todos	
F	87-90	PONTIAC BONNEVILLE Todos Strut Delantero de Diseño Inicial c/ Resorte de Seguridad	
G56703	W		141038
F	86-89	BUICK RIVIERA Todos	

Struts Ultra

Amort.	POP	No. Alternativo	Montaje Accesorio
Pos.	Año	Aplicación	
G56703	W	-continued	141038
F	87-88	CADILLAC ALLANTE Todos Exc. Suspensión Electrónica Ajustable	
F	86-89	ELDORADO Todos	
F	86-89	SEVILLE Todos	
F	86-89	OLDSMOBILE TORONADO Todos	
G56704	D		141572
R	86-93	BUICK RIVIERA Todos	
R	86-93	CADILLAC ELDORADO Todos	
R	90-93	SEVILLE Todos Suspensión c/ Sensor de Velocidad (SSS) o Manejo con Comando Computarizado (CCR); No ajustable	
R	86-89	SEVILLE Todos	
R	86-92	OLDSMOBILE TORONADO Todos	
G56705	C		142607
F	87-89	BUICK SKYHAWK Todos Derecho	
F	84-86	SKYHAWK Todos Derecho Struts de EO no reconstruibles	
F	86-91	SKYLARK Todos Derecho Struts de EO no reconstruibles	
F	85-87	SOMERSET / SOMERSET REGAL Todos Derecho Struts de EO no reconstruibles	
F	87-88	CADILLAC CIMARRON Todos Derecho	
F	84-86	CIMARRON Todos Derecho Struts de EO no reconstruibles	
F	87-91	CHEVROLET BERETTA Todos Derecho	
F	87-94	CAVALIER Todos Derecho	
F	84-86	CAVALIER Todos Derecho Struts de EO no reconstruibles	
F	87-91	CORSICA Todos Derecho	
F	87	OLDSMOBILE CALAIS Todos Derecho	
F	85-86	CALAIS Todos Derecho Struts de EO no reconstruibles	
F	88-91	CUTLASS CALAIS Todos Derecho	
F	87-88	FIRENZA Todos Derecho	
F	84-86	FIRENZA Todos Derecho Struts de EO no reconstruibles	
F	87-91	PONTIAC GRAND AM Todos Derecho	
F	85-86	GRAND AM Todos Derecho Struts de EO no reconstruibles	
F	84-85	J2000 / SUNBIRD Todos Derecho Struts de EO no reconstruibles	
F	88-94	SUNBIRD Todos Derecho	
F	86-87	SUNBIRD Todos Derecho Struts de EO no reconstruibles	
F	87-91	TEMPEST Todos Derecho	
G56706	C		142607
F	87-89	BUICK SKYHAWK Todos Izquierdo	
F	84-86	SKYHAWK Todos Izquierdo Struts de EO no reconstruibles	
F	86-91	SKYLARK Todos Izquierdo Struts de EO no reconstruibles	
F	85-87	SOMERSET / SOMERSET REGAL Todos Izquierdo Struts de EO no reconstruibles	
F	87-88	CADILLAC CIMARRON Todos Izquierdo	
F	84-86	CIMARRON Todos Izquierdo Struts de EO no reconstruibles	
F	87-91	CHEVROLET BERETTA Todos Izquierdo	
F	87-94	CAVALIER Todos Izquierdo	
F	84-86	CAVALIER Todos Izquierdo Struts de EO no reconstruibles	
F	87-91	CORSICA Todos Izquierdo	
F	87	OLDSMOBILE CALAIS Todos Izquierdo	
F	85-86	CALAIS Todos Izquierdo Struts de EO no reconstruibles	
F	88-91	CUTLASS CALAIS Todos Izquierdo	
F	87-88	FIRENZA Todos Izquierdo	
F	84-86	FIRENZA Todos Izquierdo Struts de EO no reconstruibles	
F	87-91	PONTIAC GRAND AM Todos Izquierdo	
F	85-86	GRAND AM Todos Izquierdo Struts de EO no reconstruibles	
F	84-85	J2000 / SUNBIRD Todos Izquierdo Struts de EO no reconstruibles	
F	88-94	SUNBIRD Todos Izquierdo	
F	86-87	SUNBIRD Todos Izquierdo Struts de EO no reconstruibles	
F	87-91	TEMPEST Todos Izquierdo	

Lista numérica

Amort.	POP	No. Alternativo	Montaje Accesorio
Pos.	Año	Aplicación	
G56707	D		142714
R	85-90	BUICK ELECTRA Air (RearSpringType) Reemplazo Tipo Convencional para Susp. Trasera Asistida por Aire	
R	86-99	LESABRE Coil (RearSpringType)	
R	91-96	PARK AVENUE Air (RearSpringType) Reemplazo Tipo Convencional para Susp. Trasera Asistida por Aire; Exc. Susp. Elect.	
R	93	CADILLAC 60 SPECIAL Coil (RearSpringType) Reemplazo Tipo Convencional para Susp. Trasera Asistida por Aire	
R	92-93	COMMERCIAL CHASSIS 4x2 Tracción delantera Reemplazo Tipo Convencional para Susp. Trasera Asistida por Aire; Exc. Susp. Elect.	
R	85-91	COMMERCIAL CHASSIS Todos Reemplazo Tipo Convencional para Susp. Trasera Asistida por Aire; Exc. Susp. Elect.	
R	85-93	DEVILLE Air (RearSpringType) Reemplazo Tipo Convencional para Susp. Trasera Asistida por Aire	
R	85-93	FLEETWOOD Todos Reemplazo Tipo Convencional para Susp. Trasera Asistida por Aire	
R	92-99	OLDSMOBILE 88 SERIES Todos Reemplazo Tipo Convencional para Susp. Trasera Asistida por Aire	
R	86-91	88 SERIES Coil (RearSpringType)	
R	85-96	98 Air (RearSpringType) Reemplazo Tipo Convencional	
R	96-99	LSS Coil (RearSpringType) Reemplazo Tipo Convencional para Susp. Trasera Asistida por Aire	
R	97-98	REGENCY Coil (RearSpringType)	
R	91-99	PONTIAC BONNEVILLE Coil (RearSpringType) Exc. Suspensión Electrónica Ajustable	
R	87-90	BONNEVILLE Coil (RearSpringType)	
G56708	C		141693
R	88-96	BUICK REGAL Todos	
R	90-94	CHEVROLET LUMINA Todos	
R	97	OLDSMOBILE CUTLASS / CUTLASS SUPREME Todos Exc. Struts Traseros con orificios en Montaje Inferior separados 3.2"	
R	88-96	CUTLASS / CUTLASS SUPREME Todos	
R	88-96	PONTIAC GRAND PRIX Todos	
G56712	C		141309
R	01-08	FORD KA	
G56713	X		141309
F	88-89	MAZDA 929 Todos Exc. Suspensión Electrónica Ajustable	
G56714	D		141977
F	89-98	MAZDA MPV 4x2 Tracción trasera	
G56715	D		141977
F	95-98	MAZDA MPV 4x4	
F	89-94	MPV 4x4 Exc. Sistema de Autonivelación NIVOMAT	
G56716	X		141309
F	90-91	MAZDA 929 Todos Exc. Suspensión Electrónica Ajustable	
G56717	W		141038
F	88-91	BUICK REATTA Todos	
F	90-93	RIVIERA Todos	
F	89-92	CADILLAC ALLANTE Todos Exc. Suspensión Electrónica Ajustable	
F	90-93	ELDORADO Todos	
F	90-93	SEVILLE Todos Suspensión c/ Sensor de Velocidad (SSS) o Manejo con Comando Computarizado (CCR); No ajustable	
F	90-92	OLDSMOBILE TORONADO Todos	
G56718	D		141683
F	91-99	BUICK LESABRE Todos	
F	90	LESABRE Todos Strut Delantero de Segundo Diseño sin Resorte de Seguridad	
F	91-96	PARK AVENUE Todos	
F	95-96	RIVIERA Todos	
F	93	CADILLAC 60 SPECIAL Todos	
F	92-93	COMMERCIAL CHASSIS 4x2 Tracción delantera	

Lista numérica

Amort.	POP	No. Alternativo	Montaje Accesorio
Pos.	Año	Aplicación	
G56718	D	-continued	141683
F 91		COMMERCIAL CHASSIS Todos	
F 91-93		DEVILLE Todos Exc. Suspensión Electrónica Ajustable	
F 91-93		FLEETWOOD Todos	
F 92-99		OLDSMOBILE 88 SERIES Todos	
F 90-91		88 SERIES Todos Strut Delantero de Segundo Diseño sin Resorte de Seguridad	
F 91-96		98 Todos Manejo con Comando Computarizado (CCR)	
F 95-96		AURORA Todos	
F 96-99		LSS Todos	
F 97-98		REGENCY Todos	
F 94-99		PONTIAC BONNEVILLE Todos Exc. Manejo con Comando Computarizado (CCR)	
F 91-93		BONNEVILLE Todos	
F 90		BONNEVILLE Todos Strut Delantero de Segundo Diseño sin Resorte de Seguridad	
G56719	D		142607
F 95-98		BUICK SKYLARK Todos Derecho	
F 92-94		SKYLARK Todos Derecho Exc. FE3 y Control de Manejo Electrónico	
F 95-96		CHEVROLET BERETTA Todos Derecho	
F 92-94		BERETTA Base Derecho Exc. Suspensión FE7	
F 95-96		CORSICA Todos Derecho	
F 94		CORSICA Base Derecho Exc. Suspensión FE7	
F 93		CORSICA Todos Derecho Exc. Suspensión FE7	
F 92		CORSICA LT Derecho Exc. Suspensión FE7	
F 95-98		OLDSMOBILE ACHIEVA Todos Derecho Exc. Suspensión Electrónica Ajustable	
F 92-94		ACHIEVA Todos Derecho Exc. FE3 y Control de Manejo Electrónico	
F 96-98		PONTIAC GRAND AM Todos Derecho Exc. Suspensión Electrónica Ajustable	
F 95		GRAND AM SE Derecho Exc. Suspensión Electrónica Ajustable	
F 92-94		GRAND AM SE Derecho Exc. FE3 y Control de Manejo Electrónico	
G56720	D		142607
F 95-98		BUICK SKYLARK Todos Izquierdo	
F 92-94		SKYLARK Todos Izquierdo Exc. FE3 y Control de Manejo Electrónico	
F 95-96		CHEVROLET BERETTA Todos Izquierdo	
F 92-94		BERETTA Base Izquierdo Exc. Suspensión FE7	
F 95-96		CORSICA Todos Izquierdo	
F 94		CORSICA Base Izquierdo Exc. Suspensión FE7	
F 93		CORSICA Todos Izquierdo Exc. Suspensión FE7	
F 92		CORSICA LT Izquierdo Exc. Suspensión FE7	
F 95-98		OLDSMOBILE ACHIEVA Todos Izquierdo Exc. Suspensión Electrónica Ajustable	
F 92-94		ACHIEVA Todos Izquierdo Exc. FE3 y Control de Manejo Electrónico	
F 95-98		PONTIAC GRAND AM Todos Izquierdo Exc. Suspensión Electrónica Ajustable	
F 92-94		GRAND AM SE Izquierdo Exc. FE3 y Control de Manejo Electrónico	
G56721	D		141309
F 04-06		LEXUS ES330 Todos Izquierdo Exc. Suspensión Adaptable Variable	
F 04-06		TOYOTA CAMRY Todos Izquierdo	
F 04-06		SOLARA Todos Izquierdo	
G56722	D		141309
F 04-06		LEXUS ES330 Todos Derecho Exc. Suspensión Adaptable Variable	
F 04-06		TOYOTA CAMRY Todos Derecho	
F 04-06		SOLARA Todos Derecho	
G56723	D		142607
F 92-94		BUICK SKYLARK Todos Derecho Suspensión FE3	
F 94		CHEVROLET BERETTA Z26 Derecho Suspensión FE7	
F 92-93		BERETTA GT Derecho Suspensión FE7	
F 92-93		BERETTA GTZ Derecho Suspensión FE7	
F 94		CORSICA Base Derecho Suspensión FE7	
F 93		CORSICA Todos Derecho Suspensión FE7	
F 92		CORSICA LTZ Derecho Suspensión FE7	
F 92-94		OLDSMOBILE ACHIEVA Todos Derecho Suspensión FE3	
F 92-94		PONTIAC GRAND AM GT Derecho Suspensión FE3	
G56724	D		142607
F 92-94		BUICK SKYLARK Todos Derecho Suspensión FE3	
F 94		CHEVROLET BERETTA Z26 Derecho Suspensión FE7	
F 92-93		BERETTA GT Derecho Suspensión FE7	
F 92-93		BERETTA GTZ Derecho Suspensión FE7	
F 94		CORSICA Base Derecho Suspensión FE7	
F 93		CORSICA Todos Derecho Suspensión FE7	
F 92		CORSICA LTZ Derecho Suspensión FE7	
F 92-94		OLDSMOBILE ACHIEVA Todos Derecho Suspensión FE3	
F 92-94		PONTIAC GRAND AM GT Derecho Suspensión FE3	
G56728	D		
R 04-06		LEXUS ES330 Todos Izquierdo Exc. Suspensión Adaptable Variable	
R 04-06		TOYOTA CAMRY Todos Izquierdo	
R 04-06		SOLARA Todos Izquierdo	
G56729	D		
R 04-06		LEXUS ES330 Todos Derecho Exc. Suspensión Adaptable Variable	
R 04-06		TOYOTA CAMRY Todos Derecho	
R 04-06		SOLARA Todos Derecho	
G56730	W		
F 04-06		LEXUS RX330 Todos Izquierdo Exc. Suspensión de Aire	
F 07-09		RX350 Todos Izquierdo Exc. Suspensión de Aire	
F 04-07		TOYOTA HIGHLANDER Todos Izquierdo	
G56731	W		
F 04-06		LEXUS RX330 Todos Derecho Exc. Suspensión de Aire	
F 07-09		RX350 Todos Derecho Exc. Suspensión de Aire	
F 04-07		TOYOTA HIGHLANDER Todos Derecho	
G56732	W		
R 04-06		LEXUS RX330 AWD Izquierdo Exc. Suspensión de Aire	
R 07		RX350 AWD Izquierdo Exc. Suspensión de Aire	
R 04-07		TOYOTA HIGHLANDER AWD Izquierdo	
G56733	W		
R 04-06		LEXUS RX330 AWD Derecho Exc. Suspensión de Aire	
R 07		RX350 AWD Derecho Exc. Suspensión de Aire	
R 04-07		TOYOTA HIGHLANDER AWD Derecho	
G56734	W		
R 04-06		LEXUS RX330 4x2 Tracción delantera Izquierdo Exc. Suspensión de Aire	
R 07-09		RX350 4x2 Tracción delantera Izquierdo Exc. Suspensión de Aire	
R 04-07		TOYOTA HIGHLANDER AWD Izquierdo	
G56735	W		
R 04-06		LEXUS RX330 4x2 Tracción delantera Derecho Exc. Suspensión de Aire	
R 07-09		RX350 4x2 Tracción delantera Derecho Exc. Suspensión de Aire	
R 04-07		TOYOTA HIGHLANDER 4x2 Tracción delantera Derecho	

Struts Ultra

Amort.	POP	No. Alternativo	Montaje Accesorio
Pos.	Año	Aplicación	
G56723	D	-continued	142607
F 92-93		BERETTA GTZ Izquierdo Suspensión FE7	
F 94		CORSICA Base Izquierdo Suspensión FE7	
F 93		CORSICA Todos Izquierdo Suspensión FE7	
F 92		CORSICA LTZ Izquierdo Suspensión FE7	
F 92-94		OLDSMOBILE ACHIEVA Todos Izquierdo Suspensión FE3	
F 92-94		PONTIAC GRAND AM GT Izquierdo Suspensión FE3	
G56724	D		142607
F 92-94		BUICK SKYLARK Todos Derecho Suspensión FE3	
F 94		CHEVROLET BERETTA Z26 Derecho Suspensión FE7	
F 92-93		BERETTA GT Derecho Suspensión FE7	
F 92-93		BERETTA GTZ Derecho Suspensión FE7	
F 94		CORSICA Base Derecho Suspensión FE7	
F 93		CORSICA Todos Derecho Suspensión FE7	
F 92		CORSICA LTZ Derecho Suspensión FE7	
F 92-94		OLDSMOBILE ACHIEVA Todos Derecho Suspensión FE3	
F 92-94		PONTIAC GRAND AM GT Derecho Suspensión FE3	
G56728	D		
R 04-06		LEXUS ES330 Todos Izquierdo Exc. Suspensión Adaptable Variable	
R 04-06		TOYOTA CAMRY Todos Izquierdo	
R 04-06		SOLARA Todos Izquierdo	
G56729	D		
R 04-06		LEXUS ES330 Todos Derecho Exc. Suspensión Adaptable Variable	
R 04-06		TOYOTA CAMRY Todos Derecho	
R 04-06		SOLARA Todos Derecho	
G56730	W		
F 04-06		LEXUS RX330 Todos Izquierdo Exc. Suspensión de Aire	
F 07-09		RX350 Todos Izquierdo Exc. Suspensión de Aire	
F 04-07		TOYOTA HIGHLANDER Todos Izquierdo	
G56731	W		
F 04-06		LEXUS RX330 Todos Derecho Exc. Suspensión de Aire	
F 07-09		RX350 Todos Derecho Exc. Suspensión de Aire	
F 04-07		TOYOTA HIGHLANDER Todos Derecho	
G56732	W		
R 04-06		LEXUS RX330 AWD Izquierdo Exc. Suspensión de Aire	
R 07		RX350 AWD Izquierdo Exc. Suspensión de Aire	
R 04-07		TOYOTA HIGHLANDER AWD Izquierdo	
G56733	W		
R 04-06		LEXUS RX330 AWD Derecho Exc. Suspensión de Aire	
R 07		RX350 AWD Derecho Exc. Suspensión de Aire	
R 04-07		TOYOTA HIGHLANDER AWD Derecho	
G56734	W		
R 04-06		LEXUS RX330 4x2 Tracción delantera Izquierdo Exc. Suspensión de Aire	
R 07-09		RX350 4x2 Tracción delantera Izquierdo Exc. Suspensión de Aire	
R 04-07		TOYOTA HIGHLANDER AWD Izquierdo	
G56735	W		
R 04-06		LEXUS RX330 4x2 Tracción delantera Derecho Exc. Suspensión de Aire	
R 07-09		RX350 4x2 Tracción delantera Derecho Exc. Suspensión de Aire	
R 04-07		TOYOTA HIGHLANDER 4x2 Tracción delantera Derecho	

Lista numérica

Amort.	POP	No. Alternativo	Montaje Accesorio
Pos.	Año	Aplicación	
G56736	D		141682
F 98-99		INFINITI QX4 Todos Derecho Fab. hasta 12/98	
F 97		QX4 Todos Derecho	
F 99		NISSAN PATHFINDER Todos Derecho	
F 98		PATHFINDER Todos Derecho Fab. hasta 12/98	
F 96-97		PATHFINDER Todos Derecho	
G56739	D		141682
F 98-99		INFINITI QX4 Todos Izquierdo Fab. hasta 12/98	
F 97		QX4 Todos Izquierdo	
F 99		NISSAN PATHFINDER Todos Izquierdo	
F 98		PATHFINDER Todos Izquierdo Fab. hasta 12/98	
F 96-97		PATHFINDER Todos Izquierdo	
G56740	D		
F 02-06		NISSAN ALMERA	
G56741	D		
F 02-06		NISSAN ALMERA	
G56742	A		
F 06-08		FORD FIESTA	
F 98-01		FIESTA	
G56748	B		
F 01-08		FORD KA	
G56749	B		
F 00-10		FORD COURIER	
F 98-02		FIESTA	
F 01-07		FIESTA IKON	
G56750	W		
F 00		BMW 323i Wagon Izquierdo Suspensión Deportiva	
F 01-05		325i Wagon Izquierdo Suspensión Deportiva	
F 01		325i Sedan Izquierdo Fab. hasta 9/01; Suspensión Deportiva	
F 01		330Ci Convertible Izquierdo Suspensión Deportiva	
G56751	W		
F 00		BMW 323i Wagon Derecho Suspensión Deportiva	
F 01-05		325i Wagon Derecho Suspensión Deportiva	
F 01		325i Sedan Derecho Fab. hasta 9/01; Suspensión Deportiva	
F 01		330Ci Convertible Derecho Suspensión Deportiva	
G56758	D		
F 01-02		ACURA MDX Todos Derecho	
F 03-08		HONDA PILOT Todos Derecho	
G56759	D		
F 01-02		ACURA MDX Todos Izquierdo	
F 03-08		HONDA PILOT Todos Izquierdo	
G56760	W		
F 96-02		BMW Z3 Todos Derecho	
G56761	W		
F 96-02		BMW Z3 Todos Izquierdo	
G56762	W		
F 99-02		DAEWOO LEGANZA Todos	
G56763	W		
R 99-02		DAEWOO LEGANZA Todos Derecho	
G56764	W		
R 99-02		DAEWOO LEGANZA Todos Izquierdo	
G56765	X		
F 99-02		DAEWOO NUBIRA Non-ABS Derecho	
G56767	X		
R 99-02		DAEWOO NUBIRA Non-ABS Derecho	
G56769	W		
F 97-01		CADILLAC CATERA Todos	
G56770	D		
F 97-01		BMW 740i Todos Derecho Exc. Suspensión Electrónica Ajustable	

Lista numérica

Amort.	POP	No. Alternativo	Montaje Accesorio
Pos.	Año	Aplicación	
G56770	D	-continued	
F	94-95	740I Todos Derecho Exc.	Suspensión Electrónica Ajustable
F	94-01	740IL Todos Derecho Exc.	Suspensión Electrónica Ajustable
F	94-01	750IL Todos Derecho Exc.	Suspensión Electrónica Ajustable
G56771	D		
F	97-01	BMW 740I Todos Izquierdo Exc.	Suspensión Electrónica Ajustable
F	94-95	740I Todos Izquierdo Exc.	Suspensión Electrónica Ajustable
F	94-01	740IL Todos Izquierdo Exc.	Suspensión Electrónica Ajustable
F	94-01	750IL Todos Izquierdo Exc.	Suspensión Electrónica Ajustable
G56772	C		
F	04-08	CHRYSLER PACIFICA Todos	
G56773	C	141309	
F	05-06	CHEVROLET EQUINOX Todos Izquierdo	
F	06	PONTIAC TORRENT Todos Izquierdo	
G56774	C		
F	05-06	CHEVROLET EQUINOX Todos Derecho	
F	06	PONTIAC TORRENT Todos Derecho	
G56775	W		
F	97-02	CADILLAC ELDORADO Todos Izquierdo Exc.	Suspensión Electrónica Ajustable
G56776	W		
F	97-02	CADILLAC ELDORADO Todos Derecho Exc.	Suspensión Electrónica Ajustable
G56778	C	143172	
F	03-06	DODGE SPRINTER 2500 Todos	
F	03-06	SPRINTER 3500 Todos	
F	04-06	MERCEDES-BENZ SPRINTER Todos	
G56781	W	141120	
F	01-03	KIA RIO Todos Derecho	
G56782	W		
F	01-03	KIA RIO Todos Izquierdo	
G56784	D		
F	99-02	MERCURY VILLAGER Todos Derecho	
F	99-02	NISSAN QUEST Todos Derecho	
G56785	D		
F	99-02	MERCURY VILLAGER Todos Izquierdo	
F	99-02	NISSAN QUEST Todos Izquierdo	
G56786	D		
F	00-02	KIA SPORTAGE Todos Derecho	
G56787	D		
F	00-02	KIA SPORTAGE Todos Izquierdo	
G56790	D		
F	03-04	FORD MUSTANG / MUSTANG II SVT Cobra	
F	01	MUSTANG / MUSTANG II SVT Cobra	
F	00	MUSTANG / MUSTANG II SVT Cobra R	
F	94-99	MUSTANG / MUSTANG II SVT Cobra	
F	95	MUSTANG / MUSTANG II SVT Cobra R	
G56791	D		
F	06-07	MERCEDES-BENZ C230 Todos Exc.	Suspensión Deportiva
F	02-05	C230 Coupe Exc.	Suspensión Deportiva
F	01-05	C240 4x2 Tracción trasera Exc.	Suspensión Deportiva
F	06-07	C280 4x2 Tracción trasera Exc.	Suspensión Deportiva
F	01-05	C320 Sedan, 4x2 Tracción trasera Exc.	Suspensión Deportiva
F	02-04	C320 Wagon, 4x2 Tracción trasera Exc.	Suspensión Deportiva

Struts Ultra

Amort.	POP	No. Alternativo	Montaje Accesorio
Pos.	Año	Aplicación	
G56791	D	-continued	
F	06-07	C350 Todos Exc.	Suspensión Deportiva
F	02-05	CLK320 Todos Exc.	Suspensión Deportiva
F	06-09	CLK350 Todos Exc.	Suspensión Deportiva
F	02-03	CLK430 Todos Exc.	Suspensión Deportiva
F	03-06	CLK500 Todos Exc.	Suspensión Deportiva
F	07-09	CLK550 Coupe Exc.	Suspensión Deportiva
G56792	W		
F	06-07	MERCEDES-BENZ C230 Todos	Suspensión Deportiva
F	02-05	C230 Coupe	Suspensión Deportiva
F	04-05	C240 4x2 Tracción trasera	Suspensión Deportiva
F	01-03	C240 Todos	Suspensión Deportiva
F	06-07	C280 4x2 Tracción trasera	Suspensión Deportiva
F	01-05	C320 4x2 Tracción trasera	Suspensión Deportiva
F	06-07	C350 Todos	Suspensión Deportiva
F	02-05	CLK320 Todos	Suspensión Deportiva
F	06-09	CLK350 Todos	Suspensión Deportiva
F	02-03	CLK430 Todos	Suspensión Deportiva
F	03-06	CLK500 Todos	Suspensión Deportiva
G56793	D		
F	02-04	ACURA RSX Todos Derecho	
G56794	D		
F	02-04	ACURA RSX Todos Izquierdo	
G56795	W	141198	
F	00-05	SATURN L / LS / LW SERIES Todos	Derecho
G56796	W	141198	
F	00-05	SATURN L / LS / LW SERIES Todos	Izquierdo
G56797	D	141118	
F	05	TOYOTA SIENNA 4x2 Tracción delantera	Derecho Fab. hasta 6/05; 7 Pasajeros
F	04	SIENNA 4x2 Tracción delantera	Derecho 7 Pasajeros
G56798	D	141118	
F	05	TOYOTA SIENNA 4x2 Tracción delantera	Izquierdo Fab. hasta 6/05; 7 Pasajeros
F	04	SIENNA 4x2 Tracción delantera	Izquierdo 7 Pasajeros
G56799	C	141198	
F	02-06	HONDA CR-V Todos	Derecho
G56800	C	141198	
F	02-06	HONDA CR-V Todos	Izquierdo
G56801	D	140953	
F	00-03	FORD ESCORT ZX2, Coupe, Non-ABS	Hot y Cool Coupe; Non-ABS
F	98-99	ESCORT ZX2 Cool Coupe, Non-ABS	
F	98-99	ESCORT ZX2 Hot Coupe, Non-ABS	
G56802	D	142098	
F	01-09	VOLVO S60 Todos	
F	99-06	S80 Todos	
F	05-06	V70 R Fab. desde 3/00 y Exc.	XC70, XC Cross Country y Autonivelación
F	04-06	V70 2.4 Fab. desde 3/00 y Exc.	XC70, XC Cross Country y Autonivelación
F	04-06	V70 2.5T Fab. desde 3/00 y Exc.	XC70, XC Cross Country y Autonivelación
F	00-05	V70 T5 Fab. desde 3/00 y Exc.	XC70, XC Cross Country y Autonivelación
F	04	V70 2.5T AWD Fab. desde 3/00 y Exc.	XC70, XC Cross Country y Autonivelación
F	00-03	V70 2.4T Fab. desde 3/00 y Exc.	XC70, XC Cross Country y Autonivelación

Lista numérica

Amort.	POP	No. Alternativo	Montaje Accesorio
Pos.	Año	Aplicación	
G56802	D	-continued	
F	00-03	V70 Base Fab. desde 3/00 y Exc.	XC70, XC Cross Country y Autonivelación
F	00	V70 2.4T SE Fab. desde 3/00 y Exc.	XC70, XC Cross Country y Autonivelación
F	00	V70 GLT Fab. desde 3/00 y Exc.	XC70, XC Cross Country y Autonivelación
F	00	V70 GLT SE Fab. desde 3/00 y Exc.	XC70, XC Cross Country y Autonivelación
G56805	B		
F	02-06	NISSAN SENTRA GXE	Derecho
F	02-06	SENTRA GXE Sport	Derecho
F	02-06	SENTRA XE	Derecho
F	03-04	SENTRA LE	Derecho
F	02	SENTRA CA	Derecho
G56806	B		
F	02-06	NISSAN SENTRA GXE	Izquierdo
F	02-06	SENTRA GXE Sport	Izquierdo
F	02-06	SENTRA XE	Izquierdo
F	03-04	SENTRA LE	Izquierdo
F	02	SENTRA CA	Izquierdo
G56807	B	141727	
F	06-10	JEEP COMMANDER Todos	
F	05-10	GRAND CHEROKEE	Todos
G56809	D	141156	
F	03-07	SATURN ION Todos	
G56810	B		
F	05-10	CHEVROLET COBALT LS	
F	05-10	COBALT LT	
F	10	COBALT Base	
F	10	COBALT LT Team Canada	
F	06-07	COBALT LTZ	
F	05	COBALT Base	
F	11	HHR Todos	
F	08-10	HHR LS Panel	
F	08-10	HHR LT Panel	
F	06-10	HHR LS	
F	06-10	HHR LT	
F	06-08	HHR Comfort LT	
F	06-08	HHR Elegance LT	
F	07	HHR Edición Especial	
F	07-09	PONTIAC G5 Todos	
F	05-06	PURSUIT Todos	
G56812	D	142169	
F	04-08	PONTIAC GRAND PRIX Todos	
G56813	W		
F	00-04	SUBARU OUTBACK AWD	Izquierdo
G56814	W		
F	00-04	SUBARU OUTBACK AWD	Derecho
G56817	C	142169	
F	05-10	FORD MUSTANG / MUSTANG II	Todos
G56819	W		
F	05-10	HYUNDAI TUCSON Todos	Izquierdo
F	05-10	KIA SPORTAGE Todos	Izquierdo
G56820	W		
F	05-10	HYUNDAI TUCSON Todos	Derecho
F	05-10	KIA SPORTAGE Todos	Derecho
G56821	W		
R	05-10	HYUNDAI TUCSON Todos	Derecho
R	05-10	KIA SPORTAGE Todos	Derecho
G56822	D		
R	05-10	HYUNDAI TUCSON Todos	Izquierdo
R	05-10	KIA SPORTAGE Todos	Izquierdo
G56836	C	142081	
F	06-11	FORD FOCUS Todos	Izquierdo Exc. Modelo Europa
G56837	C	142081	
F	06-11	FORD FOCUS Todos	Derecho Exc. Modelo Europa
G56838	C	141727	
F	06-10	FORD EXPLORER Todos	
F	06-10	MERCURY MOUNTAINEER Todos	

Lista numérica

Amort.	POP	No. Alternativo	Montaje Accesorio
Pos.	Año	Aplicación	
G56839	C		141727
R	06-10	FORD EXPLORER Todos	
R	06-10	MERCURY MOUNTAINEER Todos	
G56840	D		142169
F	07-10	FORD EDGE Todos Izquierdo	
F	07-10	LINCOLN MKX Todos Izquierdo	
G56841	C		142169
F	07-10	FORD EDGE Todos Derecho	
F	07-10	LINCOLN MKX Todos Derecho	
G56842	C		
F	06-13	TOYOTA YARIS Todos Izquierdo	
G56843	C		
F	06-13	TOYOTA YARIS Todos Derecho	
G56882	C		141682
F	04-10	CHEVROLET OPTRA Todos Izquierdo	
F	04-08	SUZUKI FORENZA Todos Izquierdo	
F	05-08	RENO Todos Izquierdo	
G56883	C		141682
F	04-10	CHEVROLET OPTRA Todos Derecho	
F	04-08	SUZUKI FORENZA Todos Derecho	
F	05-08	RENO Todos Derecho	
G56884	C		141682
R	04-10	CHEVROLET OPTRA Todos Izquierdo	
R	04-08	SUZUKI FORENZA Todos Izquierdo	
R	05-08	RENO Todos Izquierdo	
G56885	C		141682
R	04-10	CHEVROLET OPTRA Todos Derecho	
R	04-08	SUZUKI FORENZA Todos Derecho	
R	05-08	RENO Todos Derecho	
G56886	A		
F	09-11	CHEVROLET AVEO Todos Izquierdo	
F	04-15	AVEO Todos Izquierdo	
F	07-10	PONTIAC G3 Todos Izquierdo	
F	05-08	WAVE Todos Izquierdo	
F	04-09	SUZUKI SWIFT Todos Izquierdo	
F	10-11	SWIFT+	
G56887	A		
F	09-11	CHEVROLET AVEO Todos Derecho	
F	04-15	AVEO Todos Derecho	
F	07-10	PONTIAC G3 Todos Derecho	
F	05-08	WAVE Todos Derecho	
F	04-09	SUZUKI SWIFT Todos Derecho	
F	10-11	SWIFT+	
G56888	C		
F	07-09	LEXUS ES350 Todos Izquierdo	
F	07-11	TOYOTA AVALON Todos Izquierdo	
F	06	AVALON Todos Izquierdo Fab. desde 1/06	
F	07-11	CAMRY Todos Izquierdo	
G56889	C		
F	07-09	LEXUS ES350 Todos Derecho	
F	07-11	TOYOTA AVALON Todos Derecho	
F	06	AVALON Todos Derecho Fab. desde 1/06	
F	07-11	CAMRY Todos Derecho	
G56890	D		
F	04-09	TOYOTA PRIUS Todos Izquierdo	
G56891	D		
F	04-09	TOYOTA PRIUS Todos Derecho	
G56892	N		
F	02-03	KIA SPECTRA Todos Izquierdo	
G56893	N		
F	02-03	KIA SPECTRA Todos Derecho	
G56894	D		
F	02-07	MITSUBISHI LANCER LS	
F	07	LANCER LS Diamond	
F	04-06	LANCER Ralliart	
F	02-06	LANCER Oz Rally	
F	06	LANCER DE	
F	06	LANCER SE	
F	04	LANCER DE	
F	04	LANCER Sportback	
G56895	C		
F	03-06	DODGE VERNA	

Struts Ultra, Ultra ReadyMount

Amort.	POP	No. Alternativo	Montaje Accesorio
Pos.	Año	Aplicación	
G56896	C		
F	03-06	DODGE VERNA	
G56897	C		
R	03-06	DODGE VERNA	
G56898	C		
R	03-06	DODGE VERNA	
G56899	B		
F	08-12	AUDI A3 Todos Exc. S3 y suspensión electrónica, con cilindro exterior de 55 mm	
F	04-07	A3 Todos Exc. S3 y suspensión electrónica	
F	13-15	Q3 Todos	
F	08-14	SEAT ALTEA	
F	09-14	FREETRACK	
F	06-12	TOLEDO	
F	12-16	VOLKSWAGEN BEETLE Todos	
F	04-14	BORA	
F	09-12	CC Todos	
F	09-14	EOS Todos	
F	07-14	GOLF	
F	06-13	GTI Todos Nuevo Modelo	
F	10-13	JETTA A5 (Código plataforma del fabricante) Con cilindro exterior de 55 mm	
F	06-09	JETTA Todos	
F	12-14	PASSAT Todos Exc. Modelo 4 motion	
F	06-10	PASSAT Todos Exc. Modelo 4 motion	
F	09-16	PASSAT CC	
F	06-09	RABBIT Todos	
F	12-14	TIGUAN	
G56903	W		
R	85-90	BUICK ELECTRA Air (RearSpringType) w/Air assist Rear Susp. Std. Equip. Strut Only	
R	86-99	LESABRE Air (RearSpringType) Sistema de Autonivelación NIVOMAT de EO opcional	
R	91-96	PARK AVENUE Air (RearSpringType) Exc. Suspensión Electrónica Ajustable	
R	92-93	CADILLAC COMMERCIAL CHASSIS 4x2 Tracción delantera Suspensión Trasera Asistida por Aire; Exc. Suspensión Electrónica Ajustable	
R	91	COMMERCIAL CHASSIS Todos Suspensión Trasera Asistida por Aire; Exc. Suspensión Electrónica Ajustable	
R	85-90	COMMERCIAL CHASSIS Todos Equipamiento Estándar para Suspensión Trasera Asistida por Aire	
R	91-93	DEVILLE Air (RearSpringType) Manejo con Comando Computarizado (CCR)	
R	85-90	DEVILLE Air (RearSpringType) Equipamiento Estándar para Suspensión Trasera Asistida por Aire	
R	91-93	FLEETWOOD Todos Suspensión Trasera Asistida por Aire; Exc. Suspensión Electrónica Ajustable	
R	85-90	FLEETWOOD Todos Equipamiento Estándar para Suspensión Trasera Asistida por Aire	
R	94-99	OLDSMOBILE 88 SERIES Coil (FrontSpringType), Coil (RearSpringType) Sistema de Autonivelación NIVOMAT de EO opcional Exc. Suspensión Elect. Ajustable	
R	92-93	88 SERIES Coil (FrontSpringType), Air (RearSpringType) Sistema de Autonivelación NIVOMAT de EO opcional Exc. Suspensión Elect. Ajustable	
R	86-91	88 SERIES Air (RearSpringType) Sistema de Autonivelación NIVOMAT de EO opcional	
R	91-96	98 Air (RearSpringType) Manejo con Comando Computarizado (CCR)	
R	85-90	98 Air (RearSpringType)	
R	96-99	LSS Air (RearSpringType)	
R	97-98	REGENCY Air (RearSpringType) Sistema de Autonivelación NIVOMAT de EO opcional	

Lista numérica

Amort.	POP	No. Alternativo	Montaje Accesorio
Pos.	Año	Aplicación	
G56903	W		-continued
R	91-99	PONTIAC BONNEVILLE Air (RearSpringType) Sistema de Autonivelación NIVOMAT de EO opcional Exc. Suspensión Elect. Ajustable	
R	88-90	BONNEVILLE Air (RearSpringType) Sistema de Autonivelación NIVOMAT de EO opcional	
R	87	BONNEVILLE Todos Sistema de Autonivelación NIVOMAT de EO opcional	
G56978	B		
F	02-08	CHEVROLET CORSA	
F	03-08	MERIVA	
G56979	B		
F	02-08	CHEVROLET CORSA	
F	03-08	MERIVA	
G56982	C		
F	00-09	PEUGEOT 206	
F	09-11	207	
G56983	C		
F	00-09	PEUGEOT 206	
F	09-11	207	
G56999	D		
F	99-02	SEAT IBIZA	
Ultra ReadyMount			
G56726	W		143152
R	85-90	BUICK ELECTRA Air (RearSpringType) Reemplazo Convencional para Strut Trasero de Aire c/ Montaje Superior	
R	86-99	LESABRE Coil (RearSpringType)	
R	91-96	PARK AVENUE Air (RearSpringType) Reemplazo Convencional para Suspensión Asistida; Exc. Susp. Elec. Ajustable	
R	93	CADILLAC 60 SPECIAL Coil (RearSpringType) Reemplazo Tipo Convencional para Susp. Trasera Asistida por Aire	
R	85-93	DEVILLE Air (RearSpringType) Reemplazo Tipo Convencional para Susp. Trasera Asistida por Aire	
R	85-93	FLEETWOOD Todos Reemplazo Tipo Convencional para Susp. Trasera Asistida por Aire	
R	92-99	OLDSMOBILE 88 SERIES Coil (RearSpringType) Exc. Suspensión Electrónica Ajustable	
R	86-91	88 SERIES Coil (RearSpringType)	
R	85-96	98 Air (RearSpringType) Reemplazo Convencional	
R	96-99	LSS Coil (RearSpringType) Reemplazo Tipo Convencional para Susp. Trasera Asistida por Aire	
R	97-98	REGENCY Coil (RearSpringType)	
R	91-99	PONTIAC BONNEVILLE Coil (RearSpringType) Exc. Suspensión Electrónica Ajustable	
R	87-90	BONNEVILLE Coil (RearSpringType)	
G56727	FF		142635
R	88-96	BUICK REGAL Todos	
R	90-94	CHEVROLET LUMINA Todos	
R	88-97	OLDSMOBILE CUTLASS / CUTLASS SUPREME Todos	
R	88-96	PONTIAC GRAND PRIX Todos	
G56906	FF		
R	85-90	BUICK ELECTRA Air (RearSpringType) c/ Strut Trasero de Aire c/ Montaje Superior	
R	86-99	LESABRE Air (RearSpringType) Sistema de Autonivelación NIVOMAT de EO opcional	
R	91-96	PARK AVENUE Air (RearSpringType)	
R	93	CADILLAC 60 SPECIAL Todos Equipamiento Estándar para Suspensión Trasera Asistida por Aire	
R	91-93	DEVILLE Air (RearSpringType) Manejo con Comando Computarizado (CCR)	
R	85-90	DEVILLE Air (RearSpringType) Equipamiento Estándar para Suspensión Trasera Asistida por Aire	

Lista numérica

Amort.	POP	No. Alternativo	Montaje Accesorio
Pos.	Año	Aplicación	
G56906	FF	-continued	
R	85-93	FLEETWOOD	Todos Equipamiento Estándar para Suspensión Trasera Asistida por Aire
R	94-99	OLDSMOBILE 88 SERIES	Coil (RearSpringType) Sistema de Autonivelación NIVOMAT de EO opcional Exc. Suspensión Elect. Ajustable
R	91-93	88 SERIES Air	(RearSpringType) Sistema de Autonivelación NIVOMAT de EO opcional Exc. Suspensión Elect. Ajustable
R	86-90	88 SERIES Air	(RearSpringType) Sistema de Autonivelación NIVOMAT de EO opcional
R	91-96	98 Air	(RearSpringType) Manejo con Comando Computarizado (CCR)
R	85-90	98 Air	(RearSpringType)
R	96-99	LSS Air	(RearSpringType)
R	97-98	REGENCY Air	(RearSpringType) Sistema de Autonivelación NIVOMAT de EO opcional
R	91-99	PONTIAC BONNEVILLE Air	(RearSpringType) Sistema de Autonivelación NIVOMAT de EO opcional Exc. Suspensión Elect. Ajustable
R	88-90	BONNEVILLE Air	(RearSpringType) Sistema de Autonivelación NIVOMAT de EO opcional
R	87	BONNEVILLE	Todos Sistema de Autonivelación NIVOMAT de EO opcional
G56907	FF		
F	90-95	CHRYSLER TOWN & COUNTRY	Todos
F	87-95	DODGE CARAVAN / GRAND CARAVAN	Todos
F	86	CARAVAN / GRAND CARAVAN	Todos Fabricado desde Ene/86
F	87-88	MINI RAM	Todos
F	87-95	PLYMOUTH VOYAGER / GRAND VOYAGER	Todos
F	86	VOYAGER / GRAND VOYAGER	Todos Fabricado desde Ene/86
G56908	FF		
F	85-96	BUICK CENTURY	Todos
F	84	CENTURY	Todos Suspensión HD
F	85	SKYLARK	Todos
F	84	SKYLARK	Todos Suspensión HD
F	85-90	CHEVROLET CELEBRITY	Todos
F	84	CELEBRITY	Todos Suspensión HD
F	84-85	CITATION / CITATION II	Todos Suspensión HD
F	85-96	OLDSMOBILE CIERA / CUTLASS CIERA	Todos Exc. Suspensión Electrónica Ajustable
F	84	CIERA / CUTLASS CIERA	Todos Suspensión HD
F	87-94	CUTLASS CLASSIC / CUTLASS CRUISER	Todos Exc. Suspensión Electrónica Ajustable
F	84	OMEGA	Todos Suspensión HD
F	91	PONTIAC 6000 4x2	Tracción delantera
F	84-90	6000	Todos
F	84	PHOENIX	Todos Suspensión HD
G56909	FF		
F	91-99	BUICK LESABRE	Todos
F	90	LESABRE	Todos Strut Delantero de Diseño Tardío sin Resorte de Seguridad
F	91-96	PARK AVENUE	Todos Manejo con Comando Computarizado (CCR)
F	93	CADILLAC 60 SPECIAL	Todos
F	92-93	COMMERCIAL CHASSIS 4x2	Tracción delantera
F	91	COMMERCIAL CHASSIS	Todos
F	91-93	DEVILLE	Todos Exc. Suspensión Electrónica Ajustable
F	91-93	FLEETWOOD	Todos
F	92-99	OLDSMOBILE 88 SERIES	Todos
F	90-91	88 SERIES	Todos Strut Delantero de Diseño Tardío sin Resorte de Seguridad
F	91-96	98	Todos
F	96-99	LSS	Todos
F	97-98	REGENCY	Todos
F	94-99	PONTIAC BONNEVILLE Air	(RearSpringType) Manejo con Comando Computarizado (CCR)

Ultra ReadyMount

Amort.	POP	No. Alternativo	Montaje Accesorio
Pos.	Año	Aplicación	
G56909	FF	-continued	
F	91-93	BONNEVILLE	Todos
F	90	BONNEVILLE	Todos Strut Delantero de Diseño Tardío sin Resorte de Seguridad
G56910	FF		
F	96-00	CHRYSLER TOWN & COUNTRY	Todos
F	00	VOYAGER / GRAND VOYAGER	Todos
F	00	VOYAGER / GRAND VOYAGER	Todos Exc. Sistema de Autonivelación NIVOMAT
F	96-00	DODGE CARAVAN / GRAND CARAVAN	Todos Exc. Sistema de Autonivelación NIVOMAT
F	00	CARAVAN / GRAND CARAVAN	Todos
F	96-00	PLYMOUTH VOYAGER / GRAND VOYAGER	Todos
F	96	VOYAGER / GRAND VOYAGER	Todos Exc. Sistema de Autonivelación NIVOMAT
G56911	FF		
F	91-96	FORD ESCORT	Todos
F	90-94	MAZDA 323	Todos
F	90-94	PROTÉGÉ / PROTÉGÉ5	Todos
F	91-96	MERCURY TRACER 4x2	Tracción delantera
G56912	FF		
F	86-95	FORD TAURUS	Todos
F	86-95	MERCURY SABLE	Todos
G56913	FF		
R	86-93	FORD TAURUS	Sedan
R	86-93	MERCURY SABLE	Sedan
G56914	FF		
F	85-90	BUICK ELECTRA	Todos
F	90	LESABRE	Todos Strut Delantero de Diseño Inicial c/ Resorte de Seguridad
F	86-89	LESABRE	Todos
F	85-90	CADILLAC COMMERCIAL CHASSIS	Todos
F	85-90	DEVILLE	Todos
F	85-90	FLEETWOOD	Todos
F	86-90	OLDSMOBILE 88 SERIES	Todos Strut Delantero de Diseño Inicial c/ Resorte de Seguridad
F	85-90	98	Todos
F	87-90	PONTIAC BONNEVILLE	Todos Strut Delantero de Diseño Inicial c/ Resorte de Seguridad
G56916	FF	143068	
F	95-98	BUICK SKYLARK	Todos Derecho
F	95-96	CHEVROLET BERETTA	Todos Derecho
F	95-96	CORSICA	Todos Derecho
F	97-98	OLDSMOBILE ACHIEVA	Todos Derecho Exc. Suspensión Electrónica Ajustable
F	95-96	ACHIEVA	Todos Derecho
F	95-98	PONTIAC GRAND AM	Todos Derecho Exc. Suspensión Electrónica Ajustable
G56917	FF	143068	
F	95-98	BUICK SKYLARK	Todos Izquierdo
F	95-96	CHEVROLET BERETTA	Todos Izquierdo
F	95-96	CORSICA	Todos Izquierdo
F	97-98	OLDSMOBILE ACHIEVA	Todos Izquierdo Exc. Suspensión Electrónica Ajustable
F	95-96	ACHIEVA	Todos Izquierdo
F	95-98	PONTIAC GRAND AM	Todos Izquierdo Exc. Suspensión Electrónica Ajustable
G56919	X	143068	
F	92-94	BUICK SKYLARK	Todos Izquierdo Exc. FE3 y Control de Manejo Electrónico
F	94	CHEVROLET BERETTA	Todos Izquierdo Exc. Suspensión FE7
F	92-93	BERETTA Base	Izquierdo Exc. Suspensión FE7
F	94	CORSICA Base	Izquierdo Exc. Suspensión FE7
F	93	CORSICA	Todos Izquierdo Exc. Suspensión FE7

Lista numérica

Amort.	POP	No. Alternativo	Montaje Accesorio
Pos.	Año	Aplicación	
G56919	X	-continued 143068	
F	92	CORSICA LT	Izquierdo Exc. Suspensión FE7
F	92-94	OLDSMOBILE ACHIEVA	Todos Izquierdo Exc. FE3 y Control de Manejo Electrónico
F	92-94	PONTIAC GRAND AM SE	Izquierdo Exc. FE3 y Control de Manejo Electrónico
G56920	FF	143068	
F	87-91	CHEVROLET BERETTA	Todos Derecho
F	92-94	CAVALIER	Todos Derecho
F	87-91	CORSICA	Todos Derecho
F	92-94	PONTIAC SUNBIRD	Todos Derecho
F	87-91	TEMPEST	Todos Derecho
G56921	FF	143068	
F	87-91	CHEVROLET BERETTA	Todos Izquierdo
F	92-94	CAVALIER	Todos Izquierdo
F	87-91	CORSICA	Todos Izquierdo
F	92-94	PONTIAC SUNBIRD	Todos Izquierdo
F	87-91	TEMPEST	Todos Izquierdo
G56924	FF		
R	05-09	BUICK ALLURE	Todos Izquierdo Exc. Modelos c/ Ruedas de 17" o 18"
R	97-05	CENTURY	Todos Izquierdo
R	05-09	LACROSSE	Todos Izquierdo Exc. Modelos c/ Ruedas de 17" o 18"
R	97-04	REGAL	Todos Izquierdo
R	12-16	CHEVROLET IMPALA	Todos Izquierdo
R	00-11	IMPALA	Todos Izquierdo Exc. Modelos c/ Ruedas de 17" o 18"
R	00-07	MONTE CARLO	Todos Izquierdo Exc. Modelos c/ Ruedas de 17" o 18"
R	98-02	OLDSMOBILE INTRIGUE	Todos Izquierdo
R	97-08	PONTIAC GRAND PRIX	Todos Izquierdo Exc. Modelos c/ Ruedas de 17" o 18"
G56925	FF		
R	05-09	BUICK ALLURE	Todos Derecho Exc. Modelos c/ Ruedas de 17" o 18"
R	97-05	CENTURY	Todos Derecho
R	05-09	LACROSSE	Todos Derecho Exc. Modelos c/ Ruedas de 17" o 18"
R	97-04	REGAL	Todos Derecho
R	12-16	CHEVROLET IMPALA	Todos Derecho
R	00-11	IMPALA	Todos Derecho Exc. Modelos c/ Ruedas de 17" o 18"
R	00-07	MONTE CARLO	Todos Derecho Exc. Modelos c/ Ruedas de 17" o 18"
R	98-02	OLDSMOBILE INTRIGUE	Todos Derecho
R	97-08	PONTIAC GRAND PRIX	Todos Derecho Exc. Modelos c/ Ruedas de 17" o 18"
G56926	FF		
F	01-02	FORD ESCORT SE	
F	00-02	ESCORT ZX2	
F	99-00	ESCORT ZX2 S/R	
F	98-00	ESCORT LX	
F	98-99	ESCORT SE	
F	98-99	ESCORT SE Equi	
F	98-99	ESCORT ZX2 Equi	
F	99	ESCORT ZX2 Tipico	
F	97	ESCORT	Todos
F	97-99	MERCURY TRACER 4x2	Tracción delantera
G56927	FF		
F	04-05	CHEVROLET CLASSIC	Todos
F	97-03	MALIBU	Todos
F	99-04	OLDSMOBILE ALERO	Todos
F	97-99	CUTLASS / CUTLASS SUPREME	Todos
F	99-05	PONTIAC GRAND AM	Todos
G56928	FF		
R	04-05	CHEVROLET CLASSIC	Todos
R	00-03	MALIBU	Todos Struts Traseros con orificios en Montaje Inferior separados a 2.4" y 3.2"

Lista numérica

Amort.	POP	No. Alternativo	Montaje Accesorio
Pos.	Año	Aplicación	
G56928	FF	-continued	
R	99	MALIBU Todos Struts Traseros con orificios en Montaje Inferior separados a 2.4"	
R	98	MALIBU Todos Struts Traseros con orificios en Montaje Inferior separados a 2.4" y 3.2"	
R	99-04	OLDSMOBILE ALERO Todos	
R	99-05	PONTIAC GRAND AM Todos	
G56929	FF		
F	98-05	BUICK PARK AVENUE Todos	
F	98-99	RIVIERA Todos	
G56930	FF		
F	97-01	LEXUS ES300 Todos Izquierdo Exc. Suspensión Adaptable Variable	
F	97-03	TOYOTA AVALÓN Todos Izquierdo	
F	97-01	CAMRY Todos Izquierdo	
F	99-03	SOLARA Todos Izquierdo	
G56931	FF		
F	97-01	LEXUS ES300 Todos Derecho Exc. Suspensión Adaptable Variable	
F	97-03	TOYOTA AVALÓN Todos Derecho	
F	97-01	CAMRY Todos Derecho	
F	99-03	SOLARA Todos Derecho	
G56932	FF		
R	92-02	LEXUS ES300 Todos Izquierdo Exc. Suspensión Adaptable Variable	
R	95-03	TOYOTA AVALÓN Todos Izquierdo	
R	95-01	CAMRY Todos Izquierdo	
R	92-94	CAMRY Todos Izquierdo Struts Sellados de EO	
R	99-03	SOLARA Todos Izquierdo	
G56933	FF		
R	92-02	LEXUS ES300 Todos Derecho Exc. Suspensión Adaptable Variable	
R	95-03	TOYOTA AVALÓN Todos Derecho	
R	95-01	CAMRY Todos Derecho	
R	92-94	CAMRY Todos Derecho Struts Sellados de EO	
R	99-03	SOLARA Todos Derecho	
G56934	FF		
F	96-07	FORD TAURUS Todos Izquierdo	
F	96-05	MERCURY SABLE Todos Izquierdo	
G56935	FF		
F	95-03	FORD WINDSTAR Todos	
G56936	FF		
R	94-07	FORD TAURUS Sedan	
R	94-05	MERCURY SABLE Sedan	
G56937	FF		
F	96-07	FORD TAURUS Todos Derecho	
F	96-05	MERCURY SABLE Todos Derecho	
G56938	FF		
R	95-05	CHEVROLET CAVALIER Todos	
R	95-05	PONTIAC SUNFIRE Todos	
G56939	FF		
F	95-98	CHEVROLET CAVALIER Todos	
F	95-98	PONTIAC SUNFIRE Todos	
G56940	FF		
R	91-03	FORD ESCORT Todos	
R	91-95	MAZDA 323 Todos	
R	90-94	PROTÉGÉ / PROTÉGÉ5 Todos	
R	91-99	MERCURY TRACER 4x2 Tracción delantera	
G56942	FF		
F	95-96	TOYOTA CAMRY Todos	
G56943	FF		
R	98-02	HONDA ACCORD Todos	
G56947	FF		
F	93-97	GEO PRIZM Todos	
F	93-97	TOYOTA COROLLA Todos	
G56948	FF		
F	98-02	CHEVROLET PRIZM Todos	
F	98-02	TOYOTA COROLLA Todos	
G56949	FF		
R	98-02	CHEVROLET PRIZM Todos Izquierdo	
R	93-97	GEO PRIZM Todos Izquierdo	
R	93-02	TOYOTA COROLLA Todos Izquierdo	

Ultra ReadyMount

Amort.	POP	No. Alternativo	Montaje Accesorio
Pos.	Año	Aplicación	
G56950	FF		
R	98-02	CHEVROLET PRIZM Todos Derecho	
R	93-97	GEO PRIZM Todos Derecho	
R	93-02	TOYOTA COROLLA Todos Derecho	
G56951	FF	143035	
F	99-05	CHEVROLET CAVALIER Todos	
F	99-05	PONTIAC SUNFIRE Todos	
G56952	FF		
R	95-96	CHEVROLET LUMINA Todos Izquierdo	
G56953	FF		
R	95-96	CHEVROLET LUMINA Todos Derecho	
G56956	FF		
F	01-07	CHRYSLER TOWN & COUNTRY Todos Izquierdo	
F	01-07	VOYAGER / GRAND VOYAGER Todos Izquierdo	
F	01-07	DODGE CARAVAN / GRAND CARAVAN Todos Izquierdo	
G56957	FF		
F	01-07	CHRYSLER TOWN & COUNTRY Todos Derecho	
F	01-07	VOYAGER / GRAND VOYAGER Todos Derecho	
F	01-07	DODGE CARAVAN / GRAND CARAVAN Todos Derecho	
G56958	FF		
F	93-97	CHRYSLER CONCORDE Todos Izquierdo	
F	94-97	LHS Todos Izquierdo	
F	94-96	NEW YORKER Todos Izquierdo	
F	93-97	DODGE INTREPID Todos Izquierdo	
F	93-97	EAGLE VISION Todos Izquierdo	
G56959	FF		
F	93-97	CHRYSLER CONCORDE Todos Derecho	
F	94-97	LHS Todos Derecho	
F	94-96	NEW YORKER Todos Derecho	
F	93-97	DODGE INTREPID Todos Derecho	
F	93-97	EAGLE VISION Todos Derecho	
G56960	FF		
R	93-97	CHRYSLER CONCORDE Todos	
R	93-97	DODGE INTREPID Todos	
R	93-97	EAGLE VISION Todos	
G56961	FF		
F	94-97	HONDA ACCORD Todos	
G56962	FF		
F	99-04	CHRYSLER 300M Todos Izquierdo	
F	98-04	CONCORDE Todos Izquierdo	
F	98-04	INTREPID Todos Izquierdo	
F	99-01	LHS Todos Izquierdo	
F	98-04	DODGE INTREPID Todos Izquierdo	
G56963	FF		
F	99-04	CHRYSLER 300M Todos Derecho	
F	98-04	CONCORDE Todos Derecho	
F	98-04	INTREPID Todos Derecho	
F	99-01	LHS Todos Derecho	
F	98-04	DODGE INTREPID Todos Derecho	
G56964	FF		
R	99-04	CHRYSLER 300M Todos	
R	98-04	CONCORDE Todos	
R	99-01	LHS Todos	
R	98-04	DODGE INTREPID Todos	
G56965	FF		
F	01-10	CHRYSLER PT CRUISER Todos	
G56966	FF		
F	95-99	DODGE NEON Todos	
F	95-99	PLYMOUTH NEON Todos	
G56967	FF		
R	95-99	DODGE NEON Todos	
R	95-99	PLYMOUTH NEON Todos	
G56968	FF		
R	90-97	HONDA ACCORD Todos Izquierdo	
G56969	FF		
R	90-97	HONDA ACCORD Todos Derecho	
G56970	FF		
F	96-99	INFINITI I30 Todos Izquierdo	
F	95-99	NISSAN MAXIMA Todos Izquierdo	

Lista numérica

Amort.	POP	No. Alternativo	Montaje Accesorio
Pos.	Año	Aplicación	
G56971	FF		
F	96-99	INFINITI I30 Todos Derecho	
F	95-99	NISSAN MAXIMA Todos Derecho	
G56973	FF		
R	00-02	CHRYSLER NEON Todos Izquierdo	
R	03-05	DODGE NEON SXT Izquierdo	
R	00-05	NEON SE Izquierdo	
R	01-04	NEON R/T Izquierdo	
R	00-03	NEON LE Izquierdo	
R	01-02	NEON ACR Izquierdo	
R	01-02	NEON Base Izquierdo	
R	00-02	NEON ES Izquierdo	
R	00-02	NEON LX Izquierdo	
R	00	NEON High Line Izquierdo	
R	00-01	PLYMOUTH NEON Todos Izquierdo	
G56974	FF		
R	00-02	CHRYSLER NEON Todos Derecho	
R	03-05	DODGE NEON SXT Derecho	
R	00-05	NEON SE Derecho	
R	01-04	NEON R/T Derecho	
R	00-03	NEON LE Derecho	
R	01-02	NEON ACR Derecho	
R	01-02	NEON Base Derecho	
R	00-02	NEON ES Derecho	
R	00-02	NEON LX Derecho	
R	00	NEON High Line Derecho	
R	00-01	PLYMOUTH NEON Todos Derecho	
G56975	FF		
F	00-02	CHRYSLER NEON Todos	
F	03-05	DODGE NEON SXT	
F	00-05	NEON SE	
F	01-04	NEON R/T	
F	00-03	NEON LE	
F	01-02	NEON ACR	
F	01-02	NEON Base	
F	00-02	NEON ES	
F	00-02	NEON LX	
F	00	NEON High Line	
F	00-01	PLYMOUTH NEON Todos	
G56976	FF		
F	89-97	FORD THUNDERBIRD Todos Izquierdo Exc. Suspensión Electrónica Ajustable	
F	89-97	MERCURY COUGAR Todos Izquierdo Exc. Suspensión Electrónica Ajustable	
G56977	FF		
F	89-97	FORD THUNDERBIRD Todos Derecho Exc. Suspensión Electrónica Ajustable	
F	89-97	MERCURY COUGAR Todos Derecho Exc. Suspensión Electrónica Ajustable	
G56981	FF		
F	90-93	HONDA ACCORD Todos	
G56985	FF		
F	90-93	CHRYSLER IMPERIAL Todos Exc. Sistema de Autonivelación NIVOMAT	
F	89-94	LEBARON Todos	
F	90-93	NEW YORKER Todos Exc. Sistema de Autonivelación NIVOMAT	
F	88-93	DODGE DYNASTY Todos Exc. Sistema de Autonivelación NIVOMAT	
F	89-94	SHADOW Todos Exc. Sistema de Autonivelación NIVOMAT	
F	89-95	SPIRIT Todos Exc. Sistema de Autonivelación NIVOMAT	
F	89-95	PLYMOUTH ACCLAIM Todos Exc. Sistema de Autonivelación NIVOMAT	
F	89-94	SUNDANCE Todos Exc. Sistema de Autonivelación NIVOMAT	
G56989	FF		
F	93-98	MERCURY VILLAGER Todos Izquierdo	
F	93-98	NISSAN QUEST Todos Izquierdo	
G56990	FF		
F	93-98	MERCURY VILLAGER Todos Derecho	
F	93-98	NISSAN QUEST Todos Derecho	
G56991	FF		
F	98-02	HONDA ACCORD 2.3L 4Cyl L (2254) Izquierdo	

Lista numérica

Amort.	POP	No. Alternativo	Montaje Accesorio
Pos.	Año	Aplicación	
G56992	FF		
F	98-02	HONDA ACCORD 2.3L 4Cyl L (2254) Derecho	
G56993	FF		
F	97-01	ACURA INTEGRA GS Izquierdo	
F	94-01	INTEGRA GS-R Izquierdo	
F	94-01	INTEGRA LS Izquierdo	
F	95-96	INTEGRA Special Edition Izquierdo	
F	92-95	HONDA CIVIC Todos Izquierdo	
G56994	FF		
F	97-01	ACURA INTEGRA GS Derecho	
F	94-01	INTEGRA GS-R Derecho	
F	94-01	INTEGRA LS Derecho	
F	95-96	INTEGRA Special Edition Derecho	
F	92-95	HONDA CIVIC Todos Derecho	
G56995	FF		
R	97-01	ACURA INTEGRA GS	
R	94-01	INTEGRA GS-R	
R	94-01	INTEGRA LS	
R	95-96	INTEGRA Special Edition	
R	92-95	HONDA CIVIC Todos	
G56996	FF		
F	96-00	HONDA CIVIC Todos Izquierdo	
G56997	FF		
F	96-00	HONDA CIVIC Todos Derecho	
G56998	FF		
R	96-00	HONDA CIVIC Todos	
G57000	D		
F	07-13	CHEVROLET CHEYENNE	
F	12-13	CHEYENNE 4x4	
F	07-13	PICKUP 1/2 TON, SILVERADO 1500 4x4 Exc. Control de Manejo Electrónico	
F	07-13	PICKUP 1/2 TON, SILVERADO 1500 Crew Cab Pickup, 4x2 Tracción trasera Exc. Control de Manejo Electrónico	
F	07-13	PICKUP 1/2 TON, SILVERADO 1500 Extended Cab Pickup, 4x2 Tracción trasera Exc. Control de Manejo Electrónico	
F	07-13	GMC SIERRA 1500 4x4 Exc. Control de Manejo Electrónico	
F	07-13	SIERRA 1500 Crew Cab Pickup, 4x2 Tracción trasera Exc. Control de Manejo Electrónico	
F	07-13	SIERRA 1500 Extended Cab Pickup, 4x2 Tracción trasera Exc. Control de Manejo Electrónico	
G57001	FF		
F	93-99	NISSAN ALTIMA Todos Izquierdo	
G57002	FF		
F	93-99	NISSAN ALTIMA Todos Derecho	
G57003	FF		
R	93-01	NISSAN ALTIMA Todos Izquierdo	
G57004	FF		
R	93-01	NISSAN ALTIMA Todos Derecho	
G57005	FF		
F	85-96	VOLKSWAGEN GOLF Todos	
F	85-96	GTI	
F	85-96	JETTA Todos	
G57006	FF		
F	97-98	VOLKSWAGEN GOLF 2.0L 4Cyl L (121)	
F	97-98	GTI	
F	97-98	JETTA 2.0L 4Cyl L (121)	
G57007	FF		
F	07-11	DODGE NITRO Todos Izquierdo	
F	07-12	JEEP LIBERTY Todos Izquierdo	
F	05-06	LIBERTY GAS Izquierdo	
F	02-04	LIBERTY Todos Izquierdo	
G57008	FF		
F	07-11	DODGE NITRO Todos Derecho	
F	07-12	JEEP LIBERTY Todos Derecho	
F	05-06	LIBERTY GAS Derecho	
F	02-04	LIBERTY Todos Derecho	
G57010	FF		
F	98-04	TOYOTA TACOMA Pre Runner, 4x2 Tracción trasera	
F	95-04	TACOMA 4x4	

Ultra ReadyMount

Amort.	POP	No. Alternativo	Montaje Accesorio
Pos.	Año	Aplicación	
G57011	FF		
F	99-04	HONDA ODYSSEY Todos Izquierdo	
G57012	FF		
F	99-04	HONDA ODYSSEY Todos Derecho	
G57013	FF		
F	91-02	SATURN SC / SL / SW SERIES Todos	
G57014	FF		
R	91-02	SATURN SC / SL / SW SERIES Todos	
G57015	FF		
F	03-06	FORD EXPEDITION 4x4	
F	03-06	LINCOLN NAVIGATOR 4x4	
G57016	FF		
R	03-06	FORD EXPEDITION Todos	
R	03-06	LINCOLN NAVIGATOR Todos	
G57017	FF		
F	02-03	FORD EXPLORER Eddie Bauer	
F	02-03	EXPLORER Limited	
F	02-03	EXPLORER Postal	
F	02-03	EXPLORER XLS	
F	02-03	EXPLORER XLT	
F	02-03	MERCURY MOUNTAINEER Todos	
G57018	FF		
R	02-05	FORD EXPLORER Eddie Bauer Exc. Todos los Modelos Sport y Sport Trac	
R	02-05	EXPLORER Limited Exc. Todos los Modelos Sport y Sport Trac	
R	02-05	EXPLORER XLS	
R	02-05	EXPLORER XLT	
R	02-03	EXPLORER Postal Exc. Todos los Modelos Sport y Sport Trac	
R	02-05	MERCURY MOUNTAINEER Todos	
G57019	FF		
F	04-05	FORD EXPLORER Eddie Bauer	
F	04-05	EXPLORER Limited	
F	04-05	EXPLORER XLS	
F	04-05	EXPLORER XLT	
F	04	EXPLORER NBX	
F	04-05	MERCURY MOUNTAINEER Todos	
G57020	FF		
F	04-08	FORD LOBO PICK UP	
F	04-08	PICKUP 1/2 TON, F-150 4x4	
F	06-08	LINCOLN MARK LT 4x4	
G57021	FF	143248	
F	04-08	FORD LOBO PICK UP	
F	04-08	PICKUP 1/2 TON, F-150 4x2 Tracción trasera	
F	06-08	LINCOLN MARK LT 4x2 Tracción trasera	
G57022	FF		
F	04-07	BUICK RAINIER Todos	
F	06-09	CHEVROLET TRAILBLAZER LT	
F	02-09	TRAILBLAZER Todos	
F	06-08	TRAILBLAZER Base	
F	06-07	TRAILBLAZER A	
F	06-07	TRAILBLAZER B	
F	06-07	TRAILBLAZER LS	
F	06	TRAILBLAZER EXT	
F	06	TRAILBLAZER EXT B	
F	02-06	TRAILBLAZER EXT Todos	
F	02-09	GMC ENVOY Todos	
F	02-06	ENVOY XL Todos	
F	04-05	ENVOY XUV Todos	
F	03-08	ISUZU ASCENDER Todos	
F	02-04	OLDSMOBILE BRAVADA Todos	
F	05-09	SAAB 9-7X Todos	
G57023	FF		
F	10-13	CHEVROLET PICKUP 1/2 TON, SILVERADO 1500 Base, Standard Cab Pickup, 4x2 Tracción trasera Exc. Modelo Classic y Electronic Ride	
F	07-13	PICKUP 1/2 TON, SILVERADO 1500 WT, Standard Cab Pickup, 4x2 Tracción trasera Exc. Modelo Classic y Electronic Ride	
F	09	PICKUP 1/2 TON, SILVERADO 1500 LT, Standard Cab Pickup, 4x2 Tracción trasera Exc. Modelo Classic y Electronic Ride	

Lista numérica

Amort.	POP	No. Alternativo	Montaje Accesorio
Pos.	Año	Aplicación	
G57023	FF	-continued	
F	07-08	PICKUP 1/2 TON, SILVERADO 1500 Base, Standard Cab Pickup, 4x2 Tracción trasera Exc. Modelo Classic y Electronic Ride	
F	07	PICKUP 1/2 TON, SILVERADO 1500 LTZ, Standard Cab Pickup, 4x2 Tracción trasera Exc. Modelo Classic y Electronic Ride	
F	07-13	GMC SIERRA 1500 SLE, Standard Cab Pickup, 4x2 Tracción trasera Exc. Modelo Classic y Electronic Ride	
F	07-13	SIERRA 1500 WT, Standard Cab Pickup, 4x2 Tracción trasera Exc. Modelo Classic y Electronic Ride	
G57024	FF		
R	85-98	VOLKSWAGEN GOLF Todos	
R	85-98	GTI	
R	94-98	JETTA 1.8L 4Cyl L (109)	
R	94-98	JETTA 1.9L 4Cyl L (116)	
R	94-98	JETTA 2.0L 4Cyl L (121)	
R	85-93	JETTA Todos	
G57025	FF		
R	99-00	CHRYSLER CIRRUS Todos	
R	99-00	DODGE STRATUS Todos	
R	99-00	PLYMOUTH BREEZE Todos	
G57026	FF		
R	01-06	CHRYSLER SEBRING JR (Código plataforma del fabricante), Sedan	
R	01-06	DODGE STRATUS Sedan	
G57027	FF		
F	01-07	TOYOTA SEQUOIA Todos	
F	00-06	TUNDRA Todos	
G57028	FF		
F	01-03	ACURA EL Todos Izquierdo	
F	02-04	HONDA CIVIC SiR, Hatchback Izquierdo	
G57029	FF		
F	01-03	ACURA EL Todos Derecho	
F	02-04	HONDA CIVIC SiR, Hatchback Derecho	
G57030	FF		
F	02-06	NISSAN ALTIMA Todos Izquierdo	
F	04-08	MAXIMA Todos Izquierdo	
G57031	FF		
F	02-06	NISSAN ALTIMA Todos Derecho	
F	04-08	MAXIMA Todos Derecho	
G57032	FF		
R	01-02	HONDA CIVIC Todos Izquierdo	
G57033	FF		
R	01-02	HONDA CIVIC Todos Derecho	
G57034	FF		
F	02-06	NISSAN SENTRA Todos Izquierdo	
G57035	FF		
F	02-06	NISSAN SENTRA Todos Derecho	
G57036	FF		
R	02-06	NISSAN SENTRA Todos	
G57037	FF		
F	99	INFINITI QX4 Todos Izquierdo	
F	98	QX4 Todos Izquierdo Fabricado antes de Nov/98	
F	97	QX4 Todos Izquierdo	
F	99	NISSAN PATHFINDER Todos Izquierdo	
F	98	PATHFINDER Todos Izquierdo Fabricado antes de Nov/98	
F	96-97	PATHFINDER Todos Izquierdo	
G57038	FF		
F	99	INFINITI QX4 Todos Derecho	
F	98	QX4 Todos Derecho Fabricado antes de Nov/98	
F	97	QX4 Todos Derecho	
F	99	NISSAN PATHFINDER Todos Derecho	
F	98	PATHFINDER Todos Derecho Fabricado antes de Nov/98	
F	96-97	PATHFINDER Todos Derecho	
G57039	FF		
F	98-11	VOLKSWAGEN BEETLE Todos	
F	99-06	GOLF Todos	

Lista numérica

Amort.	POP	No. Alternativo	Montaje Accesorio
Pos.	Año	Aplicación	
G57039	FF	-continued	
F	99-05	GTI	
F	99-05	JETTA Todos	
G57040	FF		
F	93-97	VOLVO 850 Todos Exc. Sistema de Autonivelación NIVOMAT	
F	98-04	C70 Todos	
F	98-00	S70 Todos	
F	99-00	V70 R AWD Fab. hasta 3/00 y Exc. XC70, XC Cross Country	
F	98-00	V70 Base Fab. hasta 3/00 y Exc. XC70, XC Cross Country	
F	98-00	V70 GLT Fab. hasta 3/00 y Exc. XC70, XC Cross Country	
F	98-00	V70 T5 Fab. hasta 3/00 y Exc. XC70, XC Cross Country	
F	00	V70 2.4T Fab. hasta 3/00 y Exc. XC70, XC Cross Country	
F	00	V70 GLT SE Fab. hasta 3/00 y Exc. XC70, XC Cross Country	
F	98-99	V70 AWD Fab. hasta 3/00 y Exc. XC70, XC Cross Country	
F	98	V70 R Fab. hasta 3/00 y Exc. XC70, XC Cross Country	
G57041	FF		
F	02-03	LEXUS ES300 Todos Izquierdo	
F	02-03	TOYOTA CAMRY Todos Izquierdo	
G57042	FF		
F	02-03	LEXUS ES300 Todos Derecho	
F	02-03	TOYOTA CAMRY Todos Derecho	
G57043	FF		
R	02-03	LEXUS ES300 Todos Izquierdo	
R	02-03	TOYOTA CAMRY Todos Izquierdo	
G57044	FF		
R	02-03	LEXUS ES300 Todos Derecho	
R	02-03	TOYOTA CAMRY Todos Derecho	
G57045	FF		
F	01-12	FORD ESCAPE Todos Izquierdo	
F	08-11	MAZDA TRIBUTE Todos Izquierdo	
F	01-06	TRIBUTE Todos Izquierdo	
F	05-11	MERCURY MARINER Todos Izquierdo	
G57046	FF		
F	01-12	FORD ESCAPE Todos Derecho	
F	08-11	MAZDA TRIBUTE Todos Derecho	
F	01-06	TRIBUTE Todos Derecho	
F	05-11	MERCURY MARINER Todos Derecho	
G57047	FF		
F	05-10	CHEVROLET COBALT LS Izquierdo	
F	05-10	COBALT LT Izquierdo	
F	10	COBALT Base Izquierdo	
F	10	COBALT LT Team Canada Izquierdo	
F	06-07	COBALT LTZ Izquierdo	
F	05	COBALT Base Izquierdo	
F	11	HHR Todos Izquierdo	
F	08-10	HHR LS Panel Izquierdo	
F	08-10	HHR LT Panel Izquierdo	
F	06-10	HHR LS Izquierdo	
F	06-10	HHR LT Izquierdo	
F	06-08	HHR Comfort LT Izquierdo	
F	06-08	HHR Elegance LT Izquierdo	
F	07	HHR Edición Especial Izquierdo	
F	07-09	PONTIAC G5 Todos Izquierdo	
F	05-06	PURSUIT Todos Izquierdo	
G57048	FF		
F	05-10	CHEVROLET COBALT LS Derecho	
F	05-10	COBALT LT Derecho	
F	10	COBALT Base Derecho	
F	10	COBALT LT Team Canada Derecho	
F	06-07	COBALT LTZ Derecho	
F	05	COBALT Base Derecho	
F	11	HHR Todos Derecho	
F	08-10	HHR LS Panel Derecho	
F	08-10	HHR LT Panel Derecho	
F	06-10	HHR LS Derecho	
F	06-10	HHR LT Derecho	
F	06-08	HHR Comfort LT Derecho	
F	06-08	HHR Elegance LT Derecho	
F	07	HHR Edición Especial Derecho	
F	07-09	PONTIAC G5 Todos Derecho	
F	05-06	PURSUIT Todos Derecho	
G57049	FF		
F	01-05	HONDA CIVIC Coupe Izquierdo	
F	01-05	CIVIC Sedan Izquierdo	

Ultra ReadyMount

Amort.	POP	No. Alternativo	Montaje Accesorio
Pos.	Año	Aplicación	
G57050	FF		
F	01-05	HONDA CIVIC Coupe Derecho	
F	01-05	CIVIC Sedan Derecho	
G57051	FF		
F	00-05	BUICK LESABRE Todos Exc. Suspensión Electrónica Ajustable	
F	00-05	CADILLAC DEVILLE Todos Exc. Suspensión Electrónica Ajustable	
F	98-04	SEVILLE Todos Exc. Suspensión Electrónica Ajustable	
F	01-03	OLDSMOBILE AURORA Todos Exc. Suspensión Electrónica Ajustable	
F	98-99	AURORA Todos Exc. Suspensión Electrónica Ajustable	
F	00-05	PONTIAC BONNEVILLE Todos Exc. Suspensión Electrónica Ajustable	
G57052	FF		
R	96-00	FORD CONTOUR Base	
R	96-00	CONTOUR Power	
R	95-00	CONTOUR LX	
R	95-00	CONTOUR SE	
R	96-98	CONTOUR Sport	
R	95-98	CONTOUR GL	
R	99-01	MERCURY COUGAR Todos	
R	95-00	MYSTIQUE Todos	
G57053	FF		
F	06-08	DODGE PICKUP 1/2 TON, RAM 1500 4x4 Exc. Mega Cab	
G57054	FF		
F	04-07	HONDA ACCORD 2.4L 4Cyl L (144) Izquierdo	
F	03-07	ACCORD 2.4L 4Cyl L (2354) Izquierdo	
G57055	FF		
F	04-07	HONDA ACCORD 2.4L 4Cyl L (144) Derecho	
F	03-07	ACCORD 2.4L 4Cyl L (2354) Derecho	
G57056	FF		
R	04-08	ACURA TL Todos	
R	06-07	HONDA ACCORD Value Package	
R	05-07	ACCORD EX	
R	05-07	ACCORD LX	
R	07	ACCORD LX SE	
R	07	ACCORD Special Edition	
R	06	ACCORD LX Special Edition	
R	05	ACCORD DX	
R	05	ACCORD SE	
R	03-04	ACCORD Todos	
G57057	FF		
R	96-99	INFINITI I30 Todos Izquierdo	
R	95-99	NISSAN MAXIMA Todos Izquierdo	
G57058	FF		
R	96-99	INFINITI I30 Todos Derecho	
R	95-99	NISSAN MAXIMA Todos Derecho	
G57059	FF		
F	00-05	HYUNDAI SONATA Todos	
G57060	FF		
F	05-09	BUICK ALLURE Todos	
F	97-05	CENTURY Todos	
F	05-09	LACROSSE Todos	
F	97-04	REGAL Todos	
F	00-16	CHEVROLET IMPALA Todos	
F	00-07	MONTE CARLO Todos	
F	02-05	VENTURE Todos	
F	97-01	VENTURE 4x2 Tracción delantera	
F	98-02	OLDSMOBILE INTRIGUE Todos	
F	97-04	SILHOUETTE Todos	
F	97-03	PONTIAC GRAND PRIX Todos	
F	99-05	MONTANA Base	
F	97-98	TRANS SPORT Todos	
G57061	FF		
R	03-05	HONDA CIVIC Todos Izquierdo	
G57062	FF		
R	03-05	HONDA CIVIC Todos Derecho	
G57063	FF		
F	00-05	FORD FOCUS Todos Izquierdo Exc. Modelo Europa	
G57064	FF		
F	00-05	FORD FOCUS Todos Derecho Exc. Modelo Europa	

Lista numérica

Amort.	POP	No. Alternativo	Montaje Accesorio
Pos.	Año	Aplicación	
G57065	FF		
F	96-02	TOYOTA 4RUNNER Todos Izquierdo	
G57066	FF		
F	96-02	TOYOTA 4RUNNER Todos Derecho	
G57067	FF		
R	03-08	PONTIAC VIBE 4x2 Tracción delantera Izquierdo	
R	03-08	TOYOTA COROLLA Todos Izquierdo	
R	03-08	MATRIX 4x2 Tracción delantera Izquierdo	
G57068	FF		
R	03-08	PONTIAC VIBE 4x2 Tracción delantera Derecho	
R	03-08	TOYOTA COROLLA Todos Derecho	
R	03-08	MATRIX 4x2 Tracción delantera Derecho	
G57069	FF		
F	06-12	CHEVROLET MALIBU LTZ Izquierdo	
F	04-12	MALIBU LT Izquierdo	
F	04-10	MALIBU LS Izquierdo	
F	04-08	MALIBU Base Izquierdo	
F	08	MALIBU Classic LS Izquierdo	
F	08	MALIBU Classic LT Izquierdo	
F	06-07	MALIBU Maxx LS Izquierdo	
F	06-07	MALIBU SS Izquierdo	
F	04-07	MALIBU Maxx LT Izquierdo	
F	04	MALIBU Maxx Izquierdo	
F	05-10	PONTIAC G6 Sedan, 3.5L 6Cyl V (213) Izquierdo	
F	07-09	G6 Coupe, 3.5L 6Cyl V (213) Izquierdo	
F	07-09	G6 Coupe, 3.6L 6Cyl V (217) Izquierdo	
F	07-09	G6 Sedan, 3.6L 6Cyl V (217) Izquierdo	
F	06-09	G6 Coupe, 3.9L 6Cyl V (237) Izquierdo	
F	06	G6 Coupe, 3.5L 6Cyl V (214) Izquierdo	
F	06	G6 Sedan, 3.5L 6Cyl V (214) Izquierdo	
F	05	G6 Sedan, 3.5L 6Cyl V (211) Izquierdo	
F	07-09	SATURN AURA XR, 3.6L 6Cyl V (217) Izquierdo	
F	07-08	AURA XE, 3.5L 6Cyl V (213) Izquierdo	
G57070	FF		
F	06-12	CHEVROLET MALIBU LTZ Derecho	
F	04-12	MALIBU LT Derecho	
F	04-10	MALIBU LS Derecho	
F	04-08	MALIBU Base Derecho	
F	08	MALIBU Classic LS Derecho	
F	08	MALIBU Classic LT Derecho	
F	06-07	MALIBU Maxx LS Derecho	
F	06-07	MALIBU Maxx LTZ Derecho	
F	06-07	MALIBU SS Derecho	
F	04-07	MALIBU Maxx LT Derecho	
F	04	MALIBU Maxx Derecho	
F	05-10	PONTIAC G6 Sedan, 3.5L 6Cyl V (213) Derecho	
F	07-09	G6 Coupe, 3.5L 6Cyl V (213) Derecho	
F	07-09	G6 Coupe, 3.6L 6Cyl V (217) Derecho	
F	07-09	G6 Sedan, 3.6L 6Cyl V (217) Derecho	
F	06-09	G6 Coupe, 3.9L 6Cyl V (237) Derecho	
F	06	G6 Coupe, 3.5L 6Cyl V (214) Derecho	
F	06	G6 Sedan, 3.5L 6Cyl V (214) Derecho	
F	05	G6 Sedan, 3.5L 6Cyl V (211) Derecho	
F	07-09	SATURN AURA XR, 3.6L 6Cyl V (217) Derecho	
F	07-08	AURA XE, 3.5L 6Cyl V (213) Derecho	
G57071	FF		
F	05-10	CHRYSLER 300 4x2 Tracción trasera, 5.7L 8Cyl V (345) Izquierdo	
F	06-10	DODGE CHARGER 4x2 Tracción trasera, 5.7L 8Cyl V (345) Izquierdo	
F	05-08	MAGNUM 4x2 Tracción trasera, 5.7L 8Cyl V (345) Izquierdo	

Lista numérica

Amort.	POP	No. Alternativo	Montaje Accesorio
Pos.	Año	Aplicación	
G57072	FF		
F	05-10	CHRYSLER	300 4x2 Tracción trasera, 5.7L 8Cyl V (345) Derecho
F	06-10	DODGE	CHARGER 4x2 Tracción trasera, 5.7L 8Cyl V (345) Derecho
F	05-08	MAGNUM	4x2 Tracción trasera, 5.7L 8Cyl V (345) Derecho
G57073	FF		
F	01-05	CHRYSLER	SEBRING ST (Código plataforma del fabricante), Coupe Izquierdo
F	01-05	DODGE	STRATUS Coupe Izquierdo
G57074	FF		
F	01-05	CHRYSLER	SEBRING ST (Código plataforma del fabricante), Coupe Derecho
F	01-05	DODGE	STRATUS Coupe Derecho
G57075	FF		
R	01-05	CHRYSLER	SEBRING ST (Código plataforma del fabricante), Coupe
R	01-05	DODGE	STRATUS Coupe
R	99-03	MITSUBISHI	GALANT GTZ
G57076	FF		
F	04-06	TOYOTA	CAMRY 2.4L 4Cyl L (2362) Izquierdo
F	04-05	CAMRY	2.4L 4Cyl L (144) Izquierdo
F	04-06	SOLARA	2.4L 4Cyl L (2362) Izquierdo
G57077	FF		
F	04-06	TOYOTA	CAMRY 2.4L 4Cyl L (2362) Derecho
F	04-05	CAMRY	2.4L 4Cyl L (144) Derecho
F	04-06	SOLARA	2.4L 4Cyl L (2362) Derecho
G57078	FF		
R	04-06	LEXUS	ES330 Todos Izquierdo
R	04-06	TOYOTA	CAMRY Todos Izquierdo
R	04-06	SOLARA	Todos Izquierdo
G57079	FF		
R	04-06	LEXUS	ES330 Todos Derecho
R	04-06	TOYOTA	CAMRY Todos Derecho
R	04-06	SOLARA	Todos Derecho
G57080	FF		
F	10-11	FORD	CROWN VICTORIA Base
F	03-11	CROWN	VICTORIA LX
F	03-08	CROWN	VICTORIA Base
F	06	CROWN	VICTORIA LX Sport
F	05	CROWN	VICTORIA S
F	03	CROWN	VICTORIA LWB
F	03	CROWN	VICTORIA S
F	03-11	LINCOLN	TOWN CAR Todos Exc. Limo
F	03-11	MERCURY	GRAND MARQUIS Todos
G57081	FF		
F	06-11	FORD	FOCUS Todos Izquierdo Exc. Modelo Europa
G57082	FF		
F	06-11	FORD	FOCUS Todos Derecho Exc. Modelo Europa
G57083	FF		
F	06-10	JEEP	GRAND CHEROKEE 4x4, 6.1L 8Cyl V (370)
F	05-10	GRAND CHEROKEE	4x4, 4.7L 8Cyl V (285)
F	05-10	GRAND CHEROKEE	4x4, 5.7L 8Cyl V (345)
G57084	FF		
F	02-06	HONDA	CR-V Automatic Izquierdo
G57085	FF		
F	02-06	HONDA	CR-V Automatic Derecho
G57086	FF		
R	02-06	HONDA	CR-V Todos Izquierdo
G57087	FF		
R	02-06	HONDA	CR-V Todos Derecho
G57088	FF		
F	00-06	HYUNDAI	ELANTRA Automatic Izquierdo

Ultra ReadyMount

Amort.	POP	No. Alternativo	Montaje Accesorio
Pos.	Año	Aplicación	
G57089	FF		
F	00-06	HYUNDAI	ELANTRA Automatic Derecho
G57090	FF		
R	00-05	HYUNDAI	SONATA Todos Izquierdo
R	01-06	KIA	MAGENTIS Todos Izquierdo
R	01-06	OPTIMA	Todos Izquierdo
G57091	FF		
R	00-05	HYUNDAI	SONATA Todos Derecho
R	01-06	KIA	MAGENTIS Todos Derecho
R	01-06	OPTIMA	Todos Derecho
G57092	FF		
F	04-10	INFINITI	QX56 4x4
F	12-15	NISSAN	ARMADA 4x4 Exc. Sistema De Autonivelacion
F	05-11	ARMADA	4x4
F	04-11	TITAN	4x4 Exc. Offroad Package
G57093	FF		
F	08-13	MAZDA	3 GX Izquierdo
F	10-12	3	Grand Touring Izquierdo
F	10-12	3	I Touring Izquierdo
F	08-12	3	GS Izquierdo
F	08-12	3	GT Izquierdo
F	04-12	3	i Izquierdo
F	04-12	3	S Izquierdo
F	11	3	Sport GS Izquierdo
F	11	3	Sport GT Izquierdo
F	11	3	Sport GX Izquierdo
F	05	3	SP23 Izquierdo
F	06-10	5	Todos Izquierdo
G57094	FF		
F	10-13	MAZDA	3 I Touring Derecho
F	08-13	3	GT Derecho
F	08-13	3	GX Derecho
F	04-13	3	i Derecho
F	04-13	3	S Derecho
F	13	3	Grand Touring Derecho
F	13	3	GS-SKY Derecho
F	08-12	3	GS Derecho
F	11	3	Sport GS Derecho
F	11	3	Sport GT Derecho
F	05	3	SP23 Derecho
F	06-10	5	Todos Derecho
G57095	FF		
F	06-10	FORD	EXPLORER Todos
F	06-10	MERCURY	MOUNTAINEER Todos
G57096	FF		
R	06-10	FORD	EXPLORER Todos
R	06-10	MERCURY	MOUNTAINEER Todos
G57097	FF		
F	03	TOYOTA	SIENNA Todos Izquierdo
F	02	SIENNA	Todos Izquierdo Fabricado antes de Dic/02
F	98-01	SIENNA	Todos Izquierdo
G57098	FF		
F	03	TOYOTA	SIENNA Todos Derecho
F	02	SIENNA	Todos Derecho Fabricado antes de Dic/02
F	98-01	SIENNA	Todos Derecho
G57099	FF		
F	03-07	SATURN	ION Todos Izquierdo
G57100	FF		
F	03-07	SATURN	ION Todos Derecho
G57101	FF		
F	07	SATURN	VUE 2.4L 4Cyl L (145) Izquierdo
F	02-06	VUE	2.2L 4Cyl L (134) Izquierdo
G57102	FF		
F	07	SATURN	VUE 2.4L 4Cyl L (145) Derecho
F	02-06	VUE	2.2L 4Cyl L (134) Derecho
G57103	FF		
F	09-13	FORD	LOBO PICK UP
F	09-13	PICKUP	1/2 TON, F-150 Extended Cab Pickup, 4x4 Exc. Suspensión Deportiva
G57104	FF		
R	97-01	HONDA	CR-V Todos
G57105	FF		
F	00-05	TOYOTA	RAV4 AWD, Automatic Izquierdo Fabricado desde May/00

Lista numérica

Amort.	POP	No. Alternativo	Montaje Accesorio
Pos.	Año	Aplicación	
G57106	FF		
F	00-05	TOYOTA	RAV4 AWD, Automatic Derecho Fabricado desde May/00
G57107	FF		
F	93-02	CHEVROLET	CAMARO Todos Izquierdo
F	93-02	PONTIAC	FIREBIRD Todos Izquierdo
G57108	FF		
F	93-02	CHEVROLET	CAMARO Todos Derecho
F	93-02	PONTIAC	FIREBIRD Todos Derecho
G57109	FF		
F	08-12	BUICK	ENCLAVE Todos
F	09-12	CHEVROLET	TRAVERSE Todos
F	07-12	GMC	ACADIA Todos
F	07-10	SATURN	OUTLOOK Todos
G57110	FF		
F	05-06	CHEVROLET	EQUINOX Todos Izquierdo
F	06	PONTIAC	TORRENT Todos Izquierdo
G57111	FF		
F	05-06	CHEVROLET	EQUINOX Todos Derecho
F	06	PONTIAC	TORRENT Todos Derecho
G57112	FF		
F	04-08	CHRYSLER	PACIFICA Todos Izquierdo
G57113	FF		
F	04-08	CHRYSLER	PACIFICA Todos Derecho
G57114	FF		
F	03-08	TOYOTA	COROLLA Todos Izquierdo
G57115	FF		
F	03-08	TOYOTA	COROLLA Todos Derecho
G57116	FF		
F	97-01	HONDA	CR-V Todos Izquierdo
G57117	FF		
F	97-01	HONDA	CR-V Todos Derecho
G57118	FF		
F	05-11	NISSAN	PATHFINDER 4x4, 4.0L 6Cyl V (3954)
G57119	FF		
F	01-02	ACURA	MDX Todos Izquierdo
F	03-08	HONDA	PILOT AWD Izquierdo
G57120	FF		
F	01-02	ACURA	MDX Todos Derecho
F	03-08	HONDA	PILOT AWD Derecho
G57121	FF		
F	08-10	CHEVROLET	MALIBU LS, 2.4L 4Cyl L (145) Izquierdo
F	08-10	MALIBU	LT, 2.4L 4Cyl L (145) Izquierdo
F	08-10	MALIBU	LTZ, 2.4L 4Cyl L (145) Izquierdo
F	06-10	PONTIAC	G6 2.4L 4Cyl L (145) Izquierdo
F	08-09	SATURN	AURA XE, 2.4L 4Cyl L (145) Izquierdo
F	09	AURA	XR, 2.4L 4Cyl L (145) Izquierdo
F	07-08	AURA	Green Line Izquierdo
G57122	FF		
F	08-10	CHEVROLET	MALIBU LS, 2.4L 4Cyl L (145) Derecho
F	08-10	MALIBU	LT, 2.4L 4Cyl L (145) Derecho
F	08-10	MALIBU	LTZ, 2.4L 4Cyl L (145) Derecho
F	06-10	PONTIAC	G6 2.4L 4Cyl L (145) Derecho
F	08-09	SATURN	AURA XE, 2.4L 4Cyl L (145) Derecho
F	09	AURA	XR, 2.4L 4Cyl L (145) Derecho
F	07-08	AURA	Green Line Derecho

Lista numérica

Amort.	POP	No. Alternativo	Montaje Accesorio
Pos.	Año	Aplicación	
G57123 FF			
F	07-13	TOYOTA TUNDRA Crew Cab Pickup, 4x2 Tracción trasera Izquierdo Exc. Offroad y Long bed	
F	07-13	TUNDRA Standard Cab Pickup, 4x2 Tracción trasera Izquierdo Exc. Offroad y Long bed	
F	07-11	TUNDRA Crew Cab Pickup, 4x2 Tracción trasera Izquierdo Exc. Offroad and Long bed	
F	07-11	TUNDRA Standard Cab Pickup, 4x2 Tracción trasera Izquierdo Exc. Offroad and Long bed	
G57124 FF			
F	07-13	TOYOTA TUNDRA Crew Cab Pickup, 4x2 Tracción trasera Derecho Exc. Offroad y Long bed	
F	07-13	TUNDRA Standard Cab Pickup, 4x2 Tracción trasera Derecho Exc. Offroad y Long bed	
F	07-11	TUNDRA Crew Cab Pickup, 4x2 Tracción trasera Derecho Exc. Offroad and Long bed	
F	07-11	TUNDRA Standard Cab Pickup, 4x2 Tracción trasera Derecho Exc. Offroad and Long bed	
G57125 FF			
F	07-13	CHEVROLET AVALANCHE 1500 Todos Exc. Suspensión Z55 o ZW7	
F	07-13	SUBURBAN 1/2 TON, 1500 Todos Exc. Suspensión Z55 o ZW7	
F	07-14	TAHOE Todos Exc. Suspensión Z55 o ZW7	
F	07-13	GMC YUKON Todos Exc. Suspensión Z55 o ZW7	
F	07-14	YUKON XL 1/2 TON Todos Exc. Suspensión Z55 o ZW7	
G57126 FF			
F	04-08	SUZUKI FORENZA Todos Izquierdo	
F	05-08	RENO Todos Izquierdo	
G57127 FF			
F	04-08	SUZUKI FORENZA Todos Derecho	
F	05-08	RENO Todos Derecho	
G57128 FF			
R	04-08	SUZUKI FORENZA Todos Izquierdo	
R	05-08	RENO Todos Izquierdo	
G57129 FF			
R	04-08	SUZUKI FORENZA Todos Derecho	
R	05-08	RENO Todos Derecho	
G57130 FF			
F	06-11	CHEVROLET AVEO Todos Izquierdo	
F	04-15	AVEO Todos Izquierdo	
F	09-10	PONTIAC G3 Todos Izquierdo	
F	05-08	WAVE Todos Izquierdo	
F	04-09	SUZUKI SWIFT Todos Izquierdo	
G57131 FF			
F	06-11	CHEVROLET AVEO Todos Derecho	
F	04-15	AVEO Todos Derecho	
F	09-10	PONTIAC G3 Todos Derecho	
F	05-08	WAVE Todos Derecho	
F	04-09	SUZUKI SWIFT Todos Derecho	
G57132 FF			
F	09-13	FORD LOBO PICKUP	
F	11-13	PICKUP 1/2 TON, F-150 Extended Cab Pickup, 4x2 Tracción trasera	
F	09-13	PICKUP 1/2 TON, F-150 Crew Cab Pickup, 4x2 Tracción trasera	
F	09-10	PICKUP 1/2 TON, F-150 Extended Cab Pickup, 4x2 Tracción trasera, 4.6L 8Cyl V (281)	
G57133 FF			
F	03-16	TOYOTA 4RUNNER Todos Izquierdo	
F	07-12	FJ CRUISER Todos Izquierdo	
F	05-12	TACOMA Todos Izquierdo	
G57134 FF			
F	03-16	TOYOTA 4RUNNER Todos Derecho	
F	07-12	FJ CRUISER Todos Derecho	
F	05-12	TACOMA Todos Derecho	
G57135 FF			
F	00-04	AUDI A6 Todos Izquierdo	
F	00-04	A6 QUATTRO Todos Izquierdo	
F	01-05	VOLKSWAGEN PASSAT Todos Izquierdo	

Ultra ReadyMount

Amort.	POP	No. Alternativo	Montaje Accesorio
Pos.	Año	Aplicación	
G57136 FF			
F	00-04	AUDI A6 Todos Derecho	
F	00-04	A6 QUATTRO Todos Derecho	
F	01-05	VOLKSWAGEN PASSAT Todos Derecho	
G57137 FF			
F	05-07	HONDA ODYSSEY Todos Izquierdo	
G57138 FF			
F	05-07	HONDA ODYSSEY Todos Derecho	
G57139 FF			
F	01-06	HYUNDAI SANTA FE Todos Izquierdo	
G57140 FF			
F	01-06	HYUNDAI SANTA FE Todos Derecho	
G57141 FF			
F	04-08	PONTIAC GRAND PRIX Todos	
G57142 FF			
F	05-07	BUICK TERRAZA 4x2 Tracción delantera	
F	05-09	CHEVROLET UPLANDER 4x2 Tracción delantera	
F	05-09	PONTIAC MONTANA SV6, 4x2 Tracción delantera	
F	05-07	SATURN RELAY 2, 4x2 Tracción delantera	
F	05-07	RELAY 3, 4x2 Tracción delantera	
F	07	RELAY 1, 4x2 Tracción delantera	
G57144 FF			
F	02-03	INFINITI QX4 Todos Izquierdo	
F	02-04	NISSAN PATHFINDER Todos Izquierdo	
G57145 FF			
F	02-03	INFINITI QX4 Todos Derecho	
F	02-04	NISSAN PATHFINDER Todos Derecho	
G57147 FF			
F	09-10	DODGE PICKUP 1/2 TON, RAM 1500 4x4	
F	11	RAM 1500 (SEE DODGE RAM 1500) 4x4	
G57148 FF			
F	06-09	FORD FUSION Todos	
G57156 FF			
F	11-12	VOLKSWAGEN JETTA Active, Sedan	
F	11-12	JETTA Sport, Sedan	
F	11-12	JETTA Sportline, Sedan	
F	11-12	JETTA Style, Sedan	
F	09-12	JETTA Comfortline, Sedan	
F	09-12	JETTA Highline, Sedan	
F	08-12	JETTA SEL, Sedan	
F	08-12	JETTA Wagon	
F	06-12	JETTA TDI, Sedan	
F	12	JETTA Comfortline TDI, Sedan	
F	12	JETTA Highline TDI, Sedan	
F	12	JETTA TDI Premium, Sedan	
F	10-11	JETTA Base, Sedan	
F	11	JETTA Bicentenario, Sedan	
F	11	JETTA TDI Comfortline, Sedan	
F	11	JETTA TDI Highline, Sedan	
F	07-10	JETTA Wolfsburg Edition, Sedan	
F	06-10	JETTA Europa, Sedan	
F	10	JETTA City, Sedan	
F	10	JETTA Clasico, Sedan	
F	10	JETTA TDI Cup Edition, Sedan	
F	06-08	JETTA 2.0T, Sedan	
F	06-08	JETTA 2.5, Sedan	
F	06	JETTA 475 Aniversario, Sedan	
F	06	JETTA Soccer 1, Sedan	
F	06	JETTA Soccer 2, Sedan	
F	06	JETTA Value Edition, Sedan	
F	06	JETTA Wagon	
F	06	JETTA Winter 1, Sedan	
F	06	JETTA Winter 2, Sedan	
F	06-09	PASSAT 2.0T	
G57157 FF			
F	02-03	NISSAN MAXIMA Standard Izquierdo	
G57158 FF			
F	02-03	NISSAN MAXIMA Standard Derecho	
G57159 FF			
R	00-03	NISSAN MAXIMA Todos Izquierdo	

Lista numérica

Amort.	POP	No. Alternativo	Montaje Accesorio
Pos.	Año	Aplicación	
G57160 FF			
R	00-03	NISSAN MAXIMA Todos Derecho	
G57161 FF			
F	10-12	NISSAN ALTIMA SR Izquierdo	
F	07-12	ALTIMA Base Izquierdo	
F	07-12	ALTIMA S Izquierdo	
F	07-12	ALTIMA SL Izquierdo	
F	08-09	ALTIMA Coupe Izquierdo	
F	07-09	ALTIMA SE Izquierdo	
G57162 FF			
F	10-12	NISSAN ALTIMA SR Derecho	
F	07-12	ALTIMA Base Derecho	
F	07-12	ALTIMA S Derecho	
F	07-12	ALTIMA SL Derecho	
F	08-09	ALTIMA Coupe Derecho	
F	07-09	ALTIMA SE Derecho	
G57163 FF			
F	03-07	NISSAN MURANO Todos Izquierdo	
G57164 FF			
F	03-07	NISSAN MURANO Todos Derecho	
G57165 FF			
F	00-01	NISSAN MAXIMA Standard Izquierdo	
G57166 FF			
F	00-01	NISSAN MAXIMA Standard Derecho	
G57167 FF			
R	00-06	HYUNDAI ELANTRA Todos Izquierdo	
G57168 FF			
R	00-06	HYUNDAI ELANTRA Todos Derecho	
G57171 FF			
F	01-06	VOLVO S60 4x2 Tracción delantera	
F	99-03	S80 Todos	
F	00-07	V70 Todos	
G57172 FF			
F	07-13	FORD EXPEDITION Todos	
F	10-13	LINCOLN NAVIGATOR Todos	
G57173 FF			
R	12-16	FORD EXPEDITION 4x4 Exc. Suspensión de Aire	
R	12-16	EXPEDITION 4x2 Tracción trasera Exc. Suspensión de Aire	
R	10-14	EXPEDITION Todos Exc. Suspensión de Aire	
R	07-09	EXPEDITION Todos	
R	10-16	LINCOLN NAVIGATOR 4x4 Exc. Suspensión de Aire	
R	10-16	NAVIGATOR 4x2 Tracción trasera Exc. Suspensión de Aire	
G57176 FF			
F	07-12	DODGE CALIBER SXT, 2.0L 4Cyl L (122) Izquierdo	
G57177 FF			
F	07-12	DODGE CALIBER SXT, 2.0L 4Cyl L (122) Derecho	
G57178 FF			
R	07-12	DODGE CALIBER SXT, 2.0L 4Cyl L (122)	
G57202 FF			
F	09-14	NISSAN CUBE Todos Izquierdo	
F	07-11	VERSA S Izquierdo	
F	07-11	VERSA SL Izquierdo	
G57203 FF			
F	09-14	NISSAN CUBE Todos Derecho	
F	07-11	VERSA Todos Derecho	
G57204 FF			
F	06-08	TOYOTA RAV4 Todos Izquierdo	
G57205 FF			
F	06-08	TOYOTA RAV4 Todos Derecho	
G57206 FF			
F	08-10	CHRYSLER TOWN & COUNTRY Todos	
F	08-10	DODGE CARAVAN / GRAND CARAVAN Todos	
F	09-10	VOLKSWAGEN ROUTAN Todos	

Lista numérica

Amort.	POP	No. Alternativo	Montaje Accesorio
Pos.	Año	Aplicación	

Amortiguadores LTV

58183 W			
F	81-93	DODGE	PICKUP 1/2 TON, W100 SERIES Todos Exc. Kit de Levantamiento
F	61-80		PICKUP 1/2 TON, W100 SERIES Todos
F	81-93		PICKUP 1 TON, W300 SERIES Todos Exc. Suspensión Quad y Kit de Levantamiento
F	61-80		PICKUP 1 TON, W300 SERIES Todos
R	61-71		PICKUP 1 TON, W300 SERIES Todos
F	90-93		PICKUP 3/4 TON, W200 SERIES Extended Cab Pickup Exc. Kit de Levantamiento
F	88-93		PICKUP 3/4 TON, W200 SERIES Cab & Chassis Exc. Kit de Levantamiento
F	81-93		PICKUP 3/4 TON, W200 SERIES Standard Cab Pickup Exc. Kit de Levantamiento
F	86		PICKUP 3/4 TON, W200 SERIES Cab & Chassis Exc. Kit de Levantamiento
F	81-83		PICKUP 3/4 TON, W200 SERIES Cab & Chassis Exc. Kit de Levantamiento
F	81-82		PICKUP 3/4 TON, W200 SERIES Extended Cab Pickup Exc. Kit de Levantamiento
F	69-80		PICKUP 3/4 TON, W200 SERIES Todos
F	61-67		PICKUP 3/4 TON, W200 SERIES Todos
F	75-93		RAMCHARGER 4x4
F	74		RAMCHARGER Todos
F	75-81		PLYMOUTH TRAILDUSTER 4x4
F	74		TRAILDUSTER Todos
58347 D			
F	87-91	CHEVROLET	BLAZER 4x4 Automóvil Grande; Exc. Suspensión Quad y Kit de Levantamiento
F	75-86		BLAZER 4x4 Exc. Suspensión Quad y Kit de Levantamiento
F	73-74		BLAZER 4x4 Exc. Kit de Levantamiento
F	69-72		BLAZER 4x4
F	81-86		PICKUP 1/2 TON, K10 Todos Suspensión Estándar; Exc. Kit de Levantamiento
F	69-80		PICKUP 1/2 TON, K10 Todos Exc. Kit de Levantamiento
F	87		PICKUP 1/2 TON, V10 Todos Exc. Suspensión Quad y Kit de Levantamiento
F	81-86		PICKUP 3/4 TON, K20 Todos Suspensión Estándar; Exc. Kit de Levantamiento
F	69-80		PICKUP 3/4 TON, K20 Todos Exc. Kit de Levantamiento
F	87		PICKUP 3/4 TON, V20 Todos Exc. Suspensión Quad y Kit de Levantamiento
F	81-86		SUBURBAN 1/2 TON, K10 Todos Suspensión Estándar; Exc. Kit de Levantamiento
F	69-80		SUBURBAN 1/2 TON, K10 Todos Exc. Kit de Levantamiento
F	81-86		SUBURBAN 3/4 TON, K20 Todos Suspensión Estándar; Exc. Kit de Levantamiento
F	69-80		SUBURBAN 3/4 TON, K20 Todos Exc. Kit de Levantamiento
F	87-88		SUBURBAN 3/4 TON, V20 Todos Exc. Suspensión Quad y Kit de Levantamiento
F	89-91		SUBURBAN 3/4 TON, V2500 Todos Exc. Suspensión Quad y Kit de Levantamiento
F	70-91	GMC	JIMMY 4x4 Exc. Suspensión Quad y Kit de Levantamiento
F	69-86		PICKUP 1/2 TON, K15 / K1500 Todos Exc. Suspensión Quad y Kit de Levantamiento
F	87		PICKUP 1/2 TON, V1500 Todos Exc. Suspensión Quad y Kit de Levantamiento
F	69-86		PICKUP 3/4 TON, K25 / K2500 Todos Exc. Suspensión Quad y Kit de Levantamiento

Amortiguadores LTV

Amort.	POP	No. Alternativo	Montaje Accesorio
Pos.	Año	Aplicación	

58347 D -continued			
F	87		PICKUP 3/4 TON, V2500 Todos Exc. Suspensión Quad y Kit de Levantamiento
F	69-86		SUBURBAN 1/2 TON, K15 / K1500 Todos Exc. Suspensión Quad y Kit de Levantamiento
F	87-91		SUBURBAN 1/2 TON, V1500 Todos Exc. Suspensión Quad y Kit de Levantamiento
F	69-86		SUBURBAN 3/4 TON, K25 / K2500 Todos Exc. Suspensión Quad y Kit de Levantamiento
F	87-91		SUBURBAN 3/4 TON, V2500 Todos Exc. Suspensión Quad y Kit de Levantamiento
58349 C 140357			
R	87-91	CHEVROLET	BLAZER Todos Automóvil Grande; Exc. Suspensión Quad y Kit de Levantamiento
R	73-86		BLAZER Todos Exc. Kit de Levantamiento
R	73-86		PICKUP 1/2 TON, C10 Todos
R	81-86		PICKUP 1/2 TON, K10 Todos Suspensión Estándar; Exc. Kit de Levantamiento
R	73-80		PICKUP 1/2 TON, K10 Todos Exc. Kit de Levantamiento
R	87		PICKUP 1/2 TON, R10 Todos
R	87		PICKUP 1/2 TON, V10 Todos Exc. Suspensión Quad y Kit de Levantamiento
R	75-86		PICKUP 3/4 TON, C20 Standard Cab Pickup
R	73-74		PICKUP 3/4 TON, C20 Todos Standard Cab Pickup
R	81-86		PICKUP 3/4 TON, K20 Todos Suspensión Estándar; Exc. Kit de Levantamiento
R	73-80		PICKUP 3/4 TON, K20 Todos Exc. Kit de Levantamiento
R	87		PICKUP 3/4 TON, R20 Standard Cab Pickup
R	87		PICKUP 3/4 TON, V20 Todos Exc. Suspensión Quad y Kit de Levantamiento
R	73-86		SUBURBAN 1/2 TON, C10 Todos
R	81-86		SUBURBAN 1/2 TON, K10 Todos Suspensión Estándar; Exc. Kit de Levantamiento
R	73-80		SUBURBAN 1/2 TON, K10 Todos Exc. Kit de Levantamiento
R	87-88		SUBURBAN 1/2 TON, R10 Todos
R	89-91		SUBURBAN 1/2 TON, R1500 Todos
R	87-88		SUBURBAN 1/2 TON, V10 Todos Exc. Suspensión Quad y Kit de Levantamiento
R	89-91		SUBURBAN 1/2 TON, V1500 Todos Exc. Suspensión Quad y Kit de Levantamiento
R	73-86		SUBURBAN 3/4 TON, C20 Todos
R	81-86		SUBURBAN 3/4 TON, K20 Todos Suspensión Estándar; Exc. Kit de Levantamiento
R	73-80		SUBURBAN 3/4 TON, K20 Todos Exc. Kit de Levantamiento
R	87-88		SUBURBAN 3/4 TON, R20 Todos
R	89-91		SUBURBAN 3/4 TON, R2500 Todos
R	87-88		SUBURBAN 3/4 TON, V20 Todos Exc. Suspensión Quad y Kit de Levantamiento
R	89-91		SUBURBAN 3/4 TON, V2500 Todos Exc. Suspensión Quad y Kit de Levantamiento
R	73		VAN 1/2 TON, P SERIES Todos
R	73-78		VAN 3/4 TON, P SERIES Todos
R	73-91	GMC	JIMMY Todos Exc. Suspensión Quad y Kit de Levantamiento
R	73-86		PICKUP 1/2 TON, C15 / C1500 Todos
R	73-86		PICKUP 1/2 TON, K15 / K1500 Todos Exc. Suspensión Quad y Kit de Levantamiento
R	87		PICKUP 1/2 TON, R1500 Todos
R	87		PICKUP 1/2 TON, V1500 Todos Exc. Kit de Levantamiento
R	75-86		PICKUP 3/4 TON, C25 / C2500 Cab & Chassis
R	75-86		PICKUP 3/4 TON, C25 / C2500 Standard Cab Pickup
R	73-74		PICKUP 3/4 TON, C25 / C2500 Todos Exc. Crew Cab y Bonus Cab

Lista numérica

Amort.	POP	No. Alternativo	Montaje Accesorio
Pos.	Año	Aplicación	

58349 C -continued 140357			
R	73-86		PICKUP 3/4 TON, K25 / K2500 Todos Exc. Suspensión Quad y Kit de Levantamiento
R	88-89		PICKUP 3/4 TON, R2500 Todos Exc. Crew Cab y Bonus Cab
R	87		PICKUP 3/4 TON, R2500 Cab & Chassis Exc. Crew Cab y Bonus Cab
R	87		PICKUP 3/4 TON, R2500 Standard Cab Pickup Exc. Crew Cab y Bonus Cab
R	87		PICKUP 3/4 TON, V2500 Todos Exc. Kit de Levantamiento
R	73-86		SUBURBAN 1/2 TON, C15 / C1500 Todos
R	73-86		SUBURBAN 1/2 TON, K15 / K1500 Todos Exc. Suspensión Quad y Kit de Levantamiento
R	87-91		SUBURBAN 1/2 TON, R1500 Todos
R	87-91		SUBURBAN 1/2 TON, V1500 Todos Exc. Kit de Levantamiento
R	73-86		SUBURBAN 3/4 TON, C25 / C2500 Todos
R	73-86		SUBURBAN 3/4 TON, K25 / K2500 Todos Exc. Suspensión Quad y Kit de Levantamiento
R	87-91		SUBURBAN 3/4 TON, R2500 Todos
R	87-91		SUBURBAN 3/4 TON, V2500 Todos Exc. Kit de Levantamiento
R	73		VAN 1/2 TON, P SERIES Todos
R	73-78		VAN 3/4 TON, P SERIES Todos
58350 W 140126			
R	66	FORD	BRONCO Todos Toda la serie #830000
R	75-79		PICKUP 1/2 TON, F-100 4x2 Tracción trasera
R	75-79		PICKUP 1/2 TON, F-150 4x2 Tracción trasera
R	75-79		PICKUP 1 TON, F-350 / SUPERDUTY Extended Cab Pickup, 4x2 Tracción trasera
R	75-79		PICKUP 3/4 TON, F-250 / SUPERDUTY Cab & Chassis, 4x2 Tracción trasera
R	75-79		PICKUP 3/4 TON, F-250 / SUPERDUTY Standard Cab Pickup, 4x2 Tracción trasera
R	70-74		PICKUP 3/4 TON, F-250 / SUPERDUTY Standard Cab Pickup 4x2 Tracción trasera
R	75-91		VAN 1/2 TON, ECONOLINE / CLUB WAGON Todos
F	71-80	INTERNATIONAL	SCOUT II Todos
58353 X			
R	72-93	DODGE	PICKUP 1/2 TON, D100 SERIES Todos
R	72-93		PICKUP 1 TON, D300 SERIES Todos
R	72-93		PICKUP 3/4 TON, D200 SERIES Todos
R	76-93		RAMCHARGER 4x2 Tracción trasera
R	74-75		RAMCHARGER Todos
R	75-81		PLYMOUTH TRAILDUSTER 4x2 Tracción trasera
R	74		TRAILDUSTER Todos
58355 D 140702			
F	75-84	CHEVROLET	BLAZER 4x2 Tracción trasera
F	69-74		BLAZER Todos 4x2 Tracción trasera
F	63-86		PICKUP 1/2 TON, C10 Todos
F	87		PICKUP 1/2 TON, R10 Todos
F	63-86		PICKUP 1 TON, C30 Todos
F	88-91		PICKUP 1 TON, C35/3500 Cab & Chassis Exc. Eje Rígido Delantero HD
F	87-88		PICKUP 1 TON, R30 Todos
F	89		PICKUP 1 TON, R3500 Standard Cab Pickup
F	75-86		PICKUP 3/4 TON, C20 Crew Cab Pickup
F	75-86		PICKUP 3/4 TON, C20 Standard Cab Pickup
F	63-74		PICKUP 3/4 TON, C20 Todos
F	88		PICKUP 3/4 TON, R20 Todos
F	87		PICKUP 3/4 TON, R20 Crew Cab Pickup
F	87		PICKUP 3/4 TON, R20 Standard Cab Pickup
F	89		PICKUP 3/4 TON, R2500 Todos
F	63-66		SUBURBAN 1/2 TON, 1500 Todos

Lista numérica

Amort.	POP	No. Alternativo	Montaje Accesorio
Pos.	Año	Aplicación	
58355	D	-continued	140702
F	67-86	SUBURBAN 1/2 TON, C10 Todos	
F	87-88	SUBURBAN 1/2 TON, R10 Todos	
F	89-91	SUBURBAN 1/2 TON, R1500 Todos	
F	68-86	SUBURBAN 3/4 TON, C20 Todos	
F	87-88	SUBURBAN 3/4 TON, R20 Todos	
F	89-91	SUBURBAN 3/4 TON, R2500 Todos	
F	63-80	VAN 1/2 TON, P SERIES Todos	
F	73-90	VAN 1 TON, P SERIES Todos Exc. Chasis Motorhome	
F	68-72	VAN 1 TON, P SERIES Todos	
F	68-89	VAN 3/4 TON, P SERIES Todos	
F	75-84	GMC JIMMY 4x2 Tracción trasera	
F	70-74	JIMMY Todos 4x2 Tracción trasera	
F	67-86	PICKUP 1/2 TON, C15 / C1500 Todos	
F	87	PICKUP 1/2 TON, R1500 Todos	
F	88-90	PICKUP 1 TON, C35/3500 Cab & Chassis Eje Delantero Rígido HD	
F	67-78	PICKUP 1 TON, C35/3500 Todos	
F	87-91	PICKUP 1 TON, R3500 Todos	
F	85-86	PICKUP 3/4 TON, C25 / C2500 Crew Cab Pickup	
F	75-86	PICKUP 3/4 TON, C25 / C2500 Cab & Chassis	
F	75-86	PICKUP 3/4 TON, C25 / C2500 Standard Cab Pickup	
F	75-83	PICKUP 3/4 TON, C25 / C2500 Crew Cab Pickup	
F	67-74	PICKUP 3/4 TON, C25 / C2500 Todos	
F	87-89	PICKUP 3/4 TON, R2500 Todos Exc. Crew Cab y Bonus Cab	
F	63-65	PICKUP 1000 SERIES Todos	
F	63-65	PICKUP 1500 SERIES Todos	
F	68-86	SUBURBAN 1/2 TON, C15 / C1500 Todos	
F	87-91	SUBURBAN 1/2 TON, R1500 Todos	
F	68-86	SUBURBAN 3/4 TON, C25 / C2500 Todos	
F	87-91	SUBURBAN 3/4 TON, R2500 Todos	
F	67-80	VAN 1/2 TON, P SERIES Todos	
F	75-90	VAN 1 TON, P SERIES Todos Exc. Chasis Motorhome	
F	74	VAN 1 TON, P SERIES Base Exc. Chasis Motorhome	
F	73	VAN 1 TON, P SERIES Todos Exc. Chasis Motorhome	
F	68-72	VAN 1 TON, P SERIES Todos	
F	68-89	VAN 3/4 TON, P SERIES Todos	
F	63-65	VAN, PB 1000 SERIES Todos	
58357	W		
F	71-95	CHEVROLET VAN 1/2 TON, G / EXPRESS Todos	
F	70	VAN 1/2 TON, G / EXPRESS Todos Suspensión Delantera Independiente	
F	78-96	VAN 1 TON, G / EXPRESS Todos	
F	96	VAN 1 TON, G / EXPRESS Cutaway Van	
F	75	VAN 1 TON, G / EXPRESS 146.0 (WheelBase)	
F	71-74	VAN 1 TON, G / EXPRESS Todos	
F	78-95	VAN 3/4 TON, G / EXPRESS Todos Exc. PBV 8600 #	
F	70-77	VAN 3/4 TON, G / EXPRESS Todos	
F	70-95	GMC VAN 1/2 TON, G / SAVANNA Todos	
F	76-96	VAN 1 TON, G / SAVANNA Todos	
F	75	VAN 1 TON, G / SAVANNA 110.0 (WheelBase)	
F	75	VAN 1 TON, G / SAVANNA 125.0 (WheelBase)	
F	71-74	VAN 1 TON, G / SAVANNA Todos	
F	78-95	VAN 3/4 TON, G / SAVANNA Todos Exc. PBV 8600 #	
F	71-77	VAN 3/4 TON, G / SAVANNA Todos	
F	70	VAN 3/4 TON, G / SAVANNA Todos Suspensión Delantera Independiente	
58359	W		140126
F	84-86	DODGE MINI RAM Todos	
F	72-93	PICKUP 1/2 TON, D100 SERIES Todos	
F	72-93	PICKUP 3/4 TON, D200 SERIES Todos Exc. Paquete HD	
F	75-93	RAMCHARGER 4x2 Tracción trasera	
F	99-03	VAN 1/2 TON, A / B SERIES / RAM 109.3 (WheelBase) Exc. PBV 7000#	
F	81-98	VAN 1/2 TON, A / B SERIES / RAM 109.6 (WheelBase) Exc. PBV 7000#	
F	71-80	VAN 1/2 TON, A / B SERIES / RAM Todos	

Amortiguadores LTV

Amort.	POP	No. Alternativo	Montaje Accesorio
Pos.	Año	Aplicación	
58359	W	-continued	140126
F	99-03	VAN 1 TON, A / B SERIES / RAM Todos	
F	71-98	VAN 1 TON, A / B SERIES / RAM Todos Exc. Eje Delantero 4000#	
F	71-03	VAN 3/4 TON, A / B SERIES / RAM Todos	
F	78-80	VAN, CB300 Todos Exc. Eje Delantero 4000#	
F	74-77	VAN, CB300 Todos Hasta PBV 8300#	
F	75-81	PLYMOUTH TRAILDUSTER 4x2 Tracción trasera	
F	74-83	VAN 1/2 TON, PB SERIES Todos	
F	74-83	VAN 1 TON, PB SERIES Todos Exc. Eje Delantero 4000#	
F	74-83	VAN 3/4 TON, PB SERIES Todos	
58360	W		140126
F	72-93	DODGE PICKUP 1 TON, D300 SERIES Todos	
F	82-93	PICKUP 3/4 TON, D200 SERIES Todos Paquete HD	
F	81	PICKUP 3/4 TON, D200 SERIES 165.0 (WheelBase) Paquete HD	
F	77-80	PICKUP 3/4 TON, D200 SERIES Todos Paquete HD	
F	75-76	PICKUP 3/4 TON, D200 SERIES 165.0 (WheelBase) Paquete HD	
F	72-74	PICKUP 3/4 TON, D200 SERIES Todos Paquete HD	
F	71-93	VAN 1 TON, A / B SERIES / RAM Todos Con Eje Delantero 4000#	
F	74-80	VAN, CB300 Todos PBV arriba de 8300#	
F	74-83	PLYMOUTH VAN 1 TON, PB SERIES Todos Con Eje Delantero 4000#	
58366	D		
R	73-86	CHEVROLET PICKUP 1 TON, C30 Todos	
R	88-91	PICKUP 1 TON, C35/3500 Cab & Chassis Exc. Eje Rígido Delantero HD	
R	87-88	PICKUP 1 TON, R30 Todos	
R	89	PICKUP 1 TON, R3500 Standard Cab Pickup	
R	75-86	PICKUP 3/4 TON, C20 Crew Cab Pickup	
R	73-74	PICKUP 3/4 TON, C20 Todos Crew Cab Pickup	
R	88	PICKUP 3/4 TON, R20 Todos	
R	87	PICKUP 3/4 TON, R20 Crew Cab Pickup	
R	89	PICKUP 3/4 TON, R2500 Todos	
R	74-80	VAN 1/2 TON, P SERIES Todos	
R	73-99	VAN 1 TON, P SERIES Todos	
R	79-89	VAN 3/4 TON, P SERIES Todos	
R	88-91	GMC PICKUP 1 TON, C35/3500 Cab & Chassis Exc. Eje Rígido Delantero HD	
R	73-78	PICKUP 1 TON, C35/3500 Todos	
R	87-91	PICKUP 1 TON, R3500 Todos	
R	85-86	PICKUP 3/4 TON, C25 / C2500 Crew Cab Pickup	
R	75-83	PICKUP 3/4 TON, C25 / C2500 Crew Cab Pickup	
R	87-89	PICKUP 3/4 TON, R2500 Crew Cab Pickup	
R	74-80	VAN 1/2 TON, P SERIES Todos	
R	74-99	VAN 1 TON, P SERIES Todos	
R	73	VAN 1 TON, P SERIES Base Exc. Chasis Motorhome	
R	79-89	VAN 3/4 TON, P SERIES Todos	
58377	X		
R	78-79	FORD BRONCO Todos Exc. Kit de Levantamiento	
R	66-77	BRONCO Todos Desde Serie #830001; Exc. Kit de Levantamiento	
R	75-79	PICKUP 1 TON, F-350 / SUPERDUTY Standard Cab Pickup, 4x2 Tracción trasera	
R	75-79	PICKUP 3/4 TON, F-250 / SUPERDUTY Extended Cab Pickup, 4x2 Tracción trasera	
R	76-83	JEEP CHEROKEE Todos	
F	74-83	CHEROKEE Todos	
F	84-91	GRAND WAGONEER Todos	
R	84-91	GRAND WAGONEER Todos	
R	76-83	WAGONEER Todos	
F	74-83	WAGONEER Todos	

Lista numérica

Amort.	POP	No. Alternativo	Montaje Accesorio
Pos.	Año	Aplicación	
58386	W		140780
F	66-77	FORD BRONCO Todos Desde Serie #830001; Exc. Kit de Levantamiento	
F	75-79	PICKUP 1/2 TON, F-100 4x2 Tracción trasera	
F	75-79	PICKUP 1/2 TON, F-150 4x2 Tracción trasera	
F	75-79	PICKUP 1 TON, F-350 / SUPERDUTY 4x2 Tracción trasera	
F	75-79	PICKUP 3/4 TON, F-250 / SUPERDUTY 4x2 Tracción trasera	
F	77-91	VAN 1 TON, ECONOLINE / CLUB WAGON / SUPERDUTY Todos	
F	75-91	VAN 1 TON, ECONOLINE / CLUB WAGON / SUPERDUTY Todos Exc. Conversión Motorhome	
F	75-91	VAN 3/4 TON, ECONOLINE / CLUB WAGON / SUPERDUTY Todos	
58389	W		
R	81-93	DODGE PICKUP 1/2 TON, W100 SERIES Todos Exc. Kit de Levantamiento	
R	72-80	PICKUP 1/2 TON, W100 SERIES Todos	
R	81-93	PICKUP 1 TON, W300 SERIES Todos Exc. Suspensión Quad y Kit de Levantamiento	
R	72-80	PICKUP 1 TON, W300 SERIES Todos	
R	90-93	PICKUP 3/4 TON, W200 SERIES Extended Cab Pickup Exc. Kit de Levantamiento	
R	88-93	PICKUP 3/4 TON, W200 SERIES Cab & Chassis Exc. Kit de Levantamiento	
R	81-93	PICKUP 3/4 TON, W200 SERIES Standard Cab Pickup Exc. Kit de Levantamiento	
R	86	PICKUP 3/4 TON, W200 SERIES Cab & Chassis Exc. Kit de Levantamiento	
R	81-83	PICKUP 3/4 TON, W200 SERIES Cab & Chassis Exc. Kit de Levantamiento	
R	81-82	PICKUP 3/4 TON, W200 SERIES Extended Cab Pickup Exc. Kit de Levantamiento	
R	72-80	PICKUP 3/4 TON, W200 SERIES Todos	
R	76-93	RAMCHARGER 4x4	
R	76-81	PLYMOUTH TRAILDUSTER 4x4	
58394	W		140702
F	85-99	CHEVROLET VAN 1 TON, P SERIES Todos Chasis Motorhome c/ Suspensión Delantera Independiente	
F	74-84	VAN 1 TON, P SERIES Todos Chasis Motorhome	
F	85-99	GMC VAN 1 TON, P SERIES Todos Chasis Motorhome c/ Suspensión Delantera Independiente	
F	75-84	VAN 1 TON, P SERIES Todos Chasis Motorhome	
F	74	VAN 1 TON, P SERIES Motor Home Chasis Motorhome	
58403	W		
R	79-95	CHEVROLET VAN 1 TON, G / EXPRESS Cutaway Van	
F	85	VAN 1 TON, P SERIES Todos Chasis Motorhome c/ Eje de Viga Delantero en I	
R	97-04	DODGE DAKOTA Todos	
R	01-03	DURANGO 4x4	
R	01-03	DURANGO 4x2 Tracción trasera	
R	98-00	DURANGO Todos	
R	79-95	GMC VAN 1 TON, G / SAVANNA Cutaway Van	
F	85	VAN 1 TON, P SERIES Todos Chasis Motorhome c/ Eje de Viga Delantero en I	
58406	D		
R	85-96	FORD PICKUP 1/2 TON, F-150 4x2 Tracción trasera	
R	80-97	PICKUP 1 TON, F-350 / SUPERDUTY 4x2 Tracción trasera Exc. Doble Rodada Trasera	
R	97	PICKUP 3/4 TON, F-250 / SUPERDUTY 4x2 Tracción trasera PBV arriba de 8500#	
R	80-96	PICKUP 3/4 TON, F-250 / SUPERDUTY 4x2 Tracción trasera	

Lista numérica

Amort.	POP	No. Alternativo	Montaje Accesorio
Pos.	Año	Aplicación	
58409 W			
R	80-96	FORD BRONCO Todos Exc. Kit de Levantamiento	
R	80-83	PICKUP 1/2 TON, F-100 4x2 Tracción trasera	
R	80-84	PICKUP 1/2 TON, F-150 4x2 Tracción trasera	
R	90-97	PICKUP 1/2 TON, F SUPERDUTY Todos	
R	80-97	PICKUP 1 TON, F-350 / SUPERDUTY 4x2 Tracción trasera	
R	97	PICKUP, F-450 SUPERDUTY Todos	
58411 W			
F	77-86	CHEVROLET PICKUP 1 TON, K30 Todos	
F	90-91	PICKUP 1 TON, R3500 Todos	
F	89	PICKUP 1 TON, R3500 Cab & Chassis	
F	89	PICKUP 1 TON, R3500 Crew Cab Pickup	
F	87-88	PICKUP 1 TON, V30 Todos	
F	89-91	PICKUP 1 TON, V3000 / V3500 Todos	
F	77-86	GMC PICKUP 1 TON, K35 / K3500 Todos	
F	87-91	PICKUP 1 TON, V3000 / V3500 Todos	
58412 D			
R	03-07	CHEVROLET CHEYENNE PICKUP 1/2 TON, SILVERADO	
R	07	1500 4x2 Tracción trasera Exc. Suspensión Electrónica Ajustable	
R	99-06	PICKUP 1/2 TON, SILVERADO 1500 4x4 Estilo Carrocería Clásica y Antigua, Exc. Suspensión Electrónica Ajustable	
R	05-06	PICKUP 1/2 TON, SILVERADO 1500 HD Todos	
R	01-03	PICKUP 1/2 TON, SILVERADO 1500 HD Todos	
R	77-86	PICKUP 1 TON, K30 Todos	
R	90-91	PICKUP 1 TON, R3500 Todos	
R	89	PICKUP 1 TON, R3500 Cab & Chassis	
R	89	PICKUP 1 TON, R3500 Crew Cab Pickup	
R	01-09	PICKUP 1 TON, SILVERADO 3500 Todos	
R	07-10	PICKUP 1 TON, SILVERADO 3500 HD Todos	
R	87-88	PICKUP 1 TON, V30 Todos	
R	89-91	PICKUP 1 TON, V3000 / V3500 Todos	
R	99-08	PICKUP 3/4 TON, SILVERADO 2500 Todos	
R	01-10	PICKUP 3/4 TON, SILVERADO 2500 HD Todos	
R	06-07	DODGE PICKUP 1/2 TON, RAM 1500 Todos Exc. Mega Cab	
R	02-05	PICKUP 1/2 TON, RAM 1500 Todos	
R	77-86	GMC PICKUP 1 TON, K35 / K3500 Todos	
R	87-91	PICKUP 1 TON, V3000 / V3500 Todos	
R	99-06	SIERRA 1500 4x4 Estilo Carrocería Clásica y Antigua, Exc. Suspensión Electrónica Ajustable	
R	07	SIERRA 1500 CLASSIC 4x2 Tracción trasera Exc. Suspensión Electrónica Ajustable	
R	05-06	SIERRA 1500 HD Todos	
R	01-03	SIERRA 1500 HD Todos	
R	99-04	SIERRA 2500 Todos	
R	01-10	SIERRA 2500 HD Todos	
R	01-06	SIERRA 3500 Todos	
R	07-10	SIERRA 3500 HD Todos	
58413 W			
R	78-95	CHEVROLET VAN 1/2 TON, G / EXPRESS Todos	
R	78-91	VAN 1 TON, G / EXPRESS Standard Cargo Van	
R	78-91	VAN 1 TON, G / EXPRESS Standard Passenger Van	
R	78-95	VAN 3/4 TON, G / EXPRESS Todos Exc. PBV 8600 #	
R	84-86	DODGE MINI RAM Todos	
R	99-03	VAN 1/2 TON, A / B SERIES / RAM 109.3 (WheelBase) Exc. PBV 7000#	
R	81-98	VAN 1/2 TON, A / B SERIES / RAM 109.6 (WheelBase) Exc. PBV 7000#	

Amortiguadores LTV

Amort.	POP	No. Alternativo	Montaje Accesorio
Pos.	Año	Aplicación	
58413 W -continued			
R	71-80	VAN 1/2 TON, A / B SERIES / RAM Todos	
R	99-03	VAN 1 TON, A / B SERIES / RAM Todos	
R	95-98	VAN 1 TON, A / B SERIES / RAM Todos Exc. Eje Delantero 4000#	
R	71-94	VAN 1 TON, A / B SERIES / RAM Todos	
R	71-03	VAN 3/4 TON, A / B SERIES / RAM Todos	
R	74-80	VAN, CB300 Todos	
R	78-95	GMC VAN 1/2 TON, G / SAVANNA Todos	
R	85-96	VAN 1 TON, G / SAVANNA Extended Cargo Van	
R	85-96	VAN 1 TON, G / SAVANNA Extended Passenger Van	
R	79-96	VAN 1 TON, G / SAVANNA Standard Cargo Van	
R	79-96	VAN 1 TON, G / SAVANNA Standard Passenger Van	
R	78	VAN 1 TON, G / SAVANNA Cutaway Van	
R	78-95	VAN 3/4 TON, G / SAVANNA Todos Exc. PBV 8600 #	
R	74-83	PLYMOUTH VAN 1/2 TON, PB SERIES Todos	
R	74-83	VAN 1 TON, PB SERIES Todos	
R	74-83	VAN 3/4 TON, PB SERIES Todos	
58414 D 140780			
F	80-96	FORD BRONCO Todos Con o sin Suspensión Quad detrás del Eje Delantero; Exc. Kit de Levantamiento	
F	80-83	PICKUP 1/2 TON, F-100 4x2 Tracción trasera	
F	80-96	PICKUP 1/2 TON, F-150 4x4 Con o sin Suspensión Quad detrás del Eje Delantero; Exc. Kit de Levantamiento	
F	80-96	PICKUP 1/2 TON, F-150 4x2 Tracción trasera	
F	80-97	PICKUP 1 TON, F-350 / SUPERDUTY 4x2 Tracción trasera	
F	97	PICKUP 3/4 TON, F-250 / SUPERDUTY 4x2 Tracción trasera	
F	80-96	PICKUP 3/4 TON, F-250 / SUPERDUTY 4x2 Tracción trasera	
58421 W 140455			
F	05	CHEVROLET BLAZER Base, 4x2 Tracción trasera	
F	96-04	BLAZER LS, 4x2 Tracción trasera	
F	95-02	BLAZER LT, 4x2 Tracción trasera	
F	95-99	BLAZER Base, 4x2 Tracción trasera	
F	95-97	BLAZER Deluxe, 4x2 Tracción trasera	
F	83-94	BLAZER, S MODELS 4x2 Tracción trasera	
F	94-03	S10 LS, 4x2 Tracción trasera	
F	82-03	S10 Base, 4x2 Tracción trasera	
F	92-93	S10 EL, 4x2 Tracción trasera	
F	83-92	S10 Tahoe, 4x2 Tracción trasera	
F	88-90	S10 Durango, 4x2 Tracción trasera	
F	82-86	S10 Durango, 4x2 Tracción trasera	
F	72-82	FORD COURIER Todos	
F	92-04	GMC JIMMY 4x2 Tracción trasera	
F	83-91	S15 JIMMY 4x2 Tracción trasera	
F	04	SONOMA / S15 Todos 4x2 Tracción trasera	
F	82-03	SONOMA / S15 4x2 Tracción trasera	
F	78-87	SPRINT / CABALLERO 4x2 Tracción trasera	
F	71-77	SPRINT / CABALLERO Todos	
F	96-00	ISUZU HOMBRE 4x2 Tracción trasera Exc. Chasis Deportivo	
F	72-76	MAZDA B1600 Todos	
F	77-78	B1800 Todos	
F	79-84	B2000 Todos	
F	82-84	B2200 Todos	
58422 W			
R	05	CHEVROLET BLAZER Base, 4x4	
R	05	BLAZER Base, 4x2 Tracción trasera	
R	96-04	BLAZER LS, 4x4	
R	96-04	BLAZER LS, 4x2 Tracción trasera	
R	95-02	BLAZER LT, 4x2 Tracción trasera	
R	95-01	BLAZER LT, 4x4	
R	95-99	BLAZER Base, 4x4	
R	95-99	BLAZER Base, 4x2 Tracción trasera	
R	95-97	BLAZER Deluxe, 4x2 Tracción trasera	

Lista numérica

Amort.	POP	No. Alternativo	Montaje Accesorio
Pos.	Año	Aplicación	
58422 W -continued			
R	83-94	BLAZER, S MODELS Todos	
R	99-04	S10 LS, 4x4	
R	99-03	S10 Base, 4x4	
R	99-03	S10 Base, 4x2 Tracción trasera	
R	99-03	S10 LS, 4x2 Tracción trasera	
R	94-98	S10 LS	
R	82-98	S10 Base	
R	92-93	S10 EL	
R	83-92	S10 Tahoe	
R	88-90	S10 Durango	
R	82-86	S10 Durango	
R	92-05	GMC JIMMY Todos	
R	83-91	S15 JIMMY Todos	
R	82-04	SONOMA / S15 Todos	
R	91	SYCLONE Todos	
R	92-93	TYPHOON Todos	
R	98-00	ISUZU HOMBRE Todos	
R	96-97	HOMBRE 4x2 Tracción trasera	
R	96-01	OLDSMOBILE BRAVADA Todos	
R	91-94	BRAVADA Todos	
58423 W			
F	05	CHEVROLET BLAZER Base, 4x4	
F	96-04	BLAZER LS, 4x4	
F	95-01	BLAZER LT, 4x4	
F	95-99	BLAZER Base, 4x4	
F	83-94	BLAZER, S MODELS 4x4	
F	94-04	S10 LS, 4x4	
F	83-03	S10 Base, 4x4	
F	92-93	S10 EL, 4x4	
F	83-92	S10 Tahoe, 4x4	
F	88-90	S10 Durango, 4x4	
F	88	S10 Sport, 4x4	
F	83-86	S10 Durango, 4x4	
F	92-05	GMC JIMMY 4x4	
F	83-91	S15 JIMMY 4x4	
F	83-04	SONOMA / S15 4x4	
F	91	SYCLONE Todos	
F	92-93	TYPHOON Todos	
F	98-00	ISUZU HOMBRE 4x4 Chasis Deportivo	
F	96-00	HOMBRE 4x2 Tracción trasera Chasis Deportivo	
F	96-01	OLDSMOBILE BRAVADA Todos	
F	91-94	BRAVADA Todos	
58437 W			
F	87-91	CHEVROLET BLAZER 4x4 Automóvil Grande; Kit de Levantamiento de 4"; Exc. Suspensión Quad	
F	75-86	BLAZER 4x4 Con Kit de Levantamiento de 4"; Exc. Suspensión Quad	
F	73-74	BLAZER Todos 4x4; Con Kit de Levantamiento de 4"; Exc. Suspensión Quad	
F	73-86	PICKUP 1/2 TON, K10 Todos Con Kit de Levantamiento de 4"; Exc. Suspensión Quad	
F	87	PICKUP 1/2 TON, V10 Todos Con Kit de Levantamiento de 4"; Exc. Suspensión Quad	
F	73-86	PICKUP 3/4 TON, K20 Todos Con Kit de Levantamiento de 4"; Exc. Suspensión Quad	
F	87	PICKUP 3/4 TON, V20 Todos Con Kit de Levantamiento de 4"; Exc. Suspensión Quad	
F	73-86	SUBURBAN 1/2 TON, K10 Todos Con Kit de Levantamiento de 4"; Exc. Suspensión Quad	
F	89-91	SUBURBAN 1/2 TON, V1500 4x4 Con Kit de Levantamiento de 4"; Exc. Suspensión Quad	
F	73-86	SUBURBAN 3/4 TON, K20 Todos Con Kit de Levantamiento de 4"; Exc. Suspensión Quad	
F	87-88	SUBURBAN 3/4 TON, V20 Todos Con Kit de Levantamiento de 4"; Exc. Suspensión Quad	
F	89-91	SUBURBAN 3/4 TON, V2500 Todos Con Kit de Levantamiento de 4"; Exc. Suspensión Quad	
F	75-91	GMC JIMMY 4x4 Con Kit de Levantamiento de 4"; Exc. Suspensión Quad	
F	73-74	JIMMY Todos Con Kit de Levantamiento de 4"; Exc. Suspensión Quad	
F	73-86	PICKUP 1/2 TON, K15 / K1500 Todos Con Kit de Levantamiento de 4"; Exc. Suspensión Quad	

Lista numérica

Amort.	POP	No. Alternativo	Montaje Accesorio
Pos.	Año	Aplicación	
58437	W	-continued	
F	87	PICKUP 1/2 TON, V1500 Todos Con Kit de Levantamiento de 4"; Exc. Suspensión Quad	
F	73-86	PICKUP 3/4 TON, K25 / K2500 Todos Con Kit de Levantamiento de 4"; Exc. Suspensión Quad	
F	87	PICKUP 3/4 TON, V2500 Todos Con Kit de Levantamiento de 4"; Exc. Suspensión Quad	
F	73-86	SUBURBAN 1/2 TON, K15 / K1500 Todos Con Kit de Levantamiento de 4"; Exc. Suspensión Quad	
F	87-91	SUBURBAN 1/2 TON, V1500 Todos Con Kit de Levantamiento de 4"; Exc. Suspensión Quad	
F	73-86	SUBURBAN 3/4 TON, K25 / K2500 Todos Con Kit de Levantamiento de 4"; Exc. Suspensión Quad	
F	87-91	SUBURBAN 3/4 TON, V2500 Todos Con Kit de Levantamiento de 4"; Exc. Suspensión Quad	
58438	W	140357	
R	87-90	CHEVROLET BLAZER 4x4 Automóvil Grande; Kit de Levantamiento de 4"; Exc. Suspensión Quad	
R	73-86	BLAZER 4x4 Con Kit de Levantamiento de 4"; Exc. Suspensión Quad	
R	73-86	PICKUP 1/2 TON, K10 Todos Con Kit de Levantamiento de 4"; Exc. Suspensión Quad	
R	87	PICKUP 1/2 TON, V10 Todos Con Kit de Levantamiento de 4"; Exc. Suspensión Quad	
R	73-86	PICKUP 3/4 TON, K20 Todos Con Kit de Levantamiento de 4"; Exc. Suspensión Quad	
R	87	PICKUP 3/4 TON, V20 Todos Con Kit de Levantamiento de 4"; Exc. Suspensión Quad	
R	73-86	SUBURBAN 1/2 TON, K10 Todos Con Kit de Levantamiento de 4"; Exc. Suspensión Quad	
R	73-86	SUBURBAN 3/4 TON, K20 Todos Con Kit de Levantamiento de 4"; Exc. Suspensión Quad	
R	87-88	SUBURBAN 3/4 TON, V20 Todos Con Kit de Levantamiento de 4"; Exc. Suspensión Quad	
R	89-91	SUBURBAN 3/4 TON, V2500 Todos Con Kit de Levantamiento de 4"; Exc. Suspensión Quad	
R	85-91	GMC JIMMY Todos Con Kit de Levantamiento de 4"; Exc. Suspensión Quad	
R	75-84	JIMMY 4x4 Con Kit de Levantamiento de 4"; Exc. Suspensión Quad	
R	73-74	JIMMY Todos Con Kit de Levantamiento de 4"; Exc. Suspensión Quad	
R	73-86	PICKUP 1/2 TON, K15 / K1500 Todos Con Kit de Levantamiento de 4"; Exc. Suspensión Quad	
R	87	PICKUP 1/2 TON, V1500 Todos Con Kit de Levantamiento de 4"; Exc. Suspensión Quad	
R	73-86	PICKUP 3/4 TON, K25 / K2500 Todos Con Kit de Levantamiento de 4"; Exc. Suspensión Quad	
R	87	PICKUP 3/4 TON, V2500 Todos Con Kit de Levantamiento de 4"; Exc. Suspensión Quad	
R	73-86	SUBURBAN 1/2 TON, K15 / K1500 Todos Con Kit de Levantamiento de 4"; Exc. Suspensión Quad	
R	87-91	SUBURBAN 1/2 TON, V1500 Todos Con Kit de Levantamiento de 4"; Exc. Suspensión Quad	
R	73-86	SUBURBAN 3/4 TON, K25 / K2500 Todos Con Kit de Levantamiento de 4"; Exc. Suspensión Quad	
R	87-91	SUBURBAN 3/4 TON, V2500 Todos Con Kit de Levantamiento de 4"; Exc. Suspensión Quad	
58455	W		
F	86-97	FORD PICKUP 1 TON, F-350 / SUPERDUTY 4x4	
F	97	PICKUP 3/4 TON, F-250 / SUPERDUTY 4x4 PBV arriba de 8500#	

Amortiguadores LTV

Amort.	POP	No. Alternativo	Montaje Accesorio
Pos.	Año	Aplicación	
58455	W	-continued	
F	87-96	PICKUP 3/4 TON, F-250 / SUPERDUTY 4x4	
58461	W		
R	80-96	FORD PICKUP 1/2 TON, F-150 4x4 Exc. Kit de Levantamiento	
R	86-97	PICKUP 1 TON, F-350 / SUPERDUTY 4x4 Doble Rodada Trasera	
R	82-85	PICKUP 1 TON, F-350 / SUPERDUTY 4x4 Montaje Inferior Delantero Tipo Abrazadera Exc. Doble Rodado o Kit de Levantamiento	
R	80-81	PICKUP 1 TON, F-350 / SUPERDUTY 4x4 Doble Rodada Trasera	
R	97	PICKUP 3/4 TON, F-250 / SUPERDUTY 4x4 PBV arriba de 8500#	
R	86-96	PICKUP 3/4 TON, F-250 / SUPERDUTY 4x4	
R	82-85	PICKUP 3/4 TON, F-250 / SUPERDUTY 4x4 Montaje Inferior Delantero Tipo Abrazadera Exc. Doble Rodado o Kit de Levantamiento	
R	80-81	PICKUP 3/4 TON, F-250 / SUPERDUTY 4x4	
58488	D		
R	88-99	CHEVROLET PICKUP 1/2 TON, C15 / C1500 Todos	
R	88-99	PICKUP 1/2 TON, K15 / K1500 Todos	
R	01-03	PICKUP 1 TON, C35/3500 HD, Standard Cab Pickup Eje Delantero Rígido HD	
R	88-00	PICKUP 1 TON, C35/3500 Standard Cab Pickup Eje Delantero Rígido HD	
R	88-90	PICKUP 1 TON, C35/3500 Extended Cab Pickup Eje Delantero Rígido HD	
R	88-00	PICKUP 1 TON, K35 / K3500 Todos	
R	88-00	PICKUP 3/4 TON, C25 / C2500 Todos	
R	88-00	PICKUP 3/4 TON, K25 / K2500 Todos	
R	88-99	GMC PICKUP 1/2 TON, C15 / C1500 Todos	
R	88-99	PICKUP 1/2 TON, K15 / K1500 Todos	
R	98-00	PICKUP 1 TON, C35/3500 Cab & Chassis Eje Delantero Rígido HD	
R	88-97	PICKUP 1 TON, C35/3500 Todos Eje Delantero Rígido HD	
R	88-00	PICKUP 1 TON, K35 / K3500 Todos	
R	88-00	PICKUP 3/4 TON, C25 / C2500 Todos	
R	88-00	PICKUP 3/4 TON, K25 / K2500 Todos	
58489	D	141537	
F	88-99	CHEVROLET PICKUP 1/2 TON, C15 / C1500 Todos	
F	92-00	PICKUP 1 TON, C35/3500 Crew Cab Pickup Eje Delantero Rígido HD	
F	88-00	PICKUP 1 TON, C35/3500 Extended Cab Pickup Eje Delantero Rígido HD	
F	88-00	PICKUP 1 TON, C35/3500 Standard Cab Pickup Eje Delantero Rígido HD	
F	88-00	PICKUP 3/4 TON, C25 / C2500 Todos	
F	92-99	SUBURBAN 1/2 TON, C15 / C1500 Todos	
F	92-99	SUBURBAN 3/4 TON, C25 / C2500 Todos	
F	95-00	TAHOE 4x2 Tracción trasera Old Body Style	
F	88-99	GMC PICKUP 1/2 TON, C15 / C1500 Todos	
F	92-00	PICKUP 1 TON, C35/3500 Crew Cab Pickup Eje Delantero Rígido HD	
F	88-00	PICKUP 1 TON, C35/3500 Extended Cab Pickup Eje Delantero Rígido HD	
F	88-00	PICKUP 1 TON, C35/3500 Standard Cab Pickup Eje Delantero Rígido HD	
F	88-00	PICKUP 3/4 TON, C25 / C2500 Todos	
F	92-99	SUBURBAN 1/2 TON, C15 / C1500 Todos	
F	92-99	SUBURBAN 3/4 TON, C25 / C2500 Todos	
F	92-99	YUKON 4x2 Tracción trasera	

Lista numérica

Amort.	POP	No. Alternativo	Montaje Accesorio
Pos.	Año	Aplicación	
58609	W	140780	
F	99-00	CADILLAC ESCALADE Todos	
F	90-05	CHEVROLET ASTRO AWD	
F	92-94	BLAZER 4x4 Automóvil Grande	
F	88-00	PICKUP 1 TON, K35 / K3500 Todos	
F	88-00	PICKUP 3/4 TON, K25 / K2500 Todos	
F	92-99	SUBURBAN 1/2 TON, K15 / K1500 Todos	
F	92-99	SUBURBAN 3/4 TON, K25 / K2500 Todos	
F	88-00	GMC PICKUP 1 TON, K35 / K3500 Todos	
F	88-00	PICKUP 3/4 TON, K25 / K2500 Todos	
F	90-05	SAFARI AWD	
F	92-99	SUBURBAN 1/2 TON, K15 / K1500 Todos	
F	92-99	SUBURBAN 3/4 TON, K25 / K2500 Todos	
58622	D	142617	
F	10-14	FORD VAN 1 TON, ECONOLINE / CLUB WAGON / SUPERDUTY Todos	
F	04-11	VAN 1 TON, ECONOLINE / CLUB WAGON / SUPERDUTY Todos Exc. Cutaway Chassis	
F	04-11	VAN 1 TON, ECONOLINE / CLUB WAGON / SUPERDUTY Todos Exc. Paquete de Ambulancia y Manejo	
F	07-08	VAN 1 TON, ECONOLINE / CLUB WAGON / SUPERDUTY Todos Conversión a Motorhome	
F	07-08	VAN 1 TON, ECONOLINE / CLUB WAGON / SUPERDUTY Todos	
F	92-05	VAN 1 TON, ECONOLINE / CLUB WAGON / SUPERDUTY Todos Conversión a Motorhome	
F	92-05	VAN 1 TON, ECONOLINE / CLUB WAGON / SUPERDUTY Todos	
F	01-03	VAN 1 TON, ECONOLINE / CLUB WAGON / SUPERDUTY Todos	
F	92-14	VAN 3/4 TON, ECONOLINE / CLUB WAGON / SUPERDUTY Todos	
58623	D	142617	
R	10-14	FORD VAN 1/2 TON, ECONOLINE / CLUB WAGON Todos	
R	10-14	VAN 1 TON, ECONOLINE / CLUB WAGON / SUPERDUTY Todos	
R	04-11	VAN 1 TON, ECONOLINE / CLUB WAGON / SUPERDUTY Todos Exc. Cutaway Chassis	
R	04-11	VAN 1 TON, ECONOLINE / CLUB WAGON / SUPERDUTY Todos Exc. Paquete de Ambulancia y Manejo	
R	07-08	VAN 1 TON, ECONOLINE / CLUB WAGON / SUPERDUTY Todos Conversión a Motorhome	
R	07-08	VAN 1 TON, ECONOLINE / CLUB WAGON / SUPERDUTY Todos	
R	92-05	VAN 1 TON, ECONOLINE / CLUB WAGON / SUPERDUTY Todos Conversión a Motorhome	
R	92-05	VAN 1 TON, ECONOLINE / CLUB WAGON / SUPERDUTY Todos	
R	01-03	VAN 1 TON, ECONOLINE / CLUB WAGON / SUPERDUTY Todos	
R	92-14	VAN 3/4 TON, ECONOLINE / CLUB WAGON / SUPERDUTY Todos	
58624	W	140780	
R	92-09	FORD VAN 1/2 TON, ECONOLINE / CLUB WAGON Todos	
58638	D		
R	99-00	CADILLAC ESCALADE Todos	
R	92-94	CHEVROLET BLAZER 4x4 Automóvil Grande	
R	92-99	SUBURBAN 1/2 TON, C15 / C1500 Todos	
R	92-99	SUBURBAN 1/2 TON, K15 / K1500 Todos	
R	92-99	SUBURBAN 3/4 TON, C25 / C2500 Todos	
R	92-99	SUBURBAN 3/4 TON, K25 / K2500 Todos	
R	95-00	TAHOE Todos Old Body Style	
R	96-11	VAN 1/2 TON, G / EXPRESS Todos	
R	10-12	VAN 1 TON, G / EXPRESS Todos	
R	03-06	VAN 1 TON, G / EXPRESS Todos	

Lista numérica

Amort.	POP	No. Alternativo	Montaje Accesorio
Pos.	Año	Aplicación	
58638	D	-continued	
R	07-09	VAN 3/4 TON, G / EXPRESS Todos	
R	96-02	VAN 3/4 TON, G / EXPRESS Todos Exc. PBV 8600 #	
R	92-99	GMC SUBURBAN 1/2 TON, C15 / C1500 Todos	
R	92-99	SUBURBAN 1/2 TON, K15 / K1500 Todos	
R	92-99	SUBURBAN 3/4 TON, C25 / C2500 Todos	
R	92-99	SUBURBAN 3/4 TON, K25 / K2500 Todos	
R	08-11	VAN 1/2 TON, G / SAVANNA Todos	
R	96-06	VAN 1/2 TON, G / SAVANNA Todos	
R	96-02	VAN 1 TON, G / SAVANNA Todos Exc. PBV 8600 #	
R	96-02	VAN 3/4 TON, G / SAVANNA Todos Exc. PBV 8600 #	
R	92-99	YUKON Todos	
R	99	YUKON Denali	
58661	D	143000	
F	94-01	DODGE PICKUP 1/2 TON, RAM 1500 4x2 Tracción trasera	
F	94-02	PICKUP 1 TON, RAM 3500 4x2 Tracción trasera Exc. Eje Delantero Rígido	
F	94-02	PICKUP 3/4 TON, RAM 2500 4x2 Tracción trasera	
58662	D		
R	03-07	CHEVROLET CHEYENNE	
R	99-06	PICKUP 1/2 TON, SILVERADO 1500 4x2 Tracción trasera Exc. Suspensión Electrónica Ajustable	
R	07	SILVERADO 1500 CLASSIC 4x2 Tracción trasera Exc. Suspensión Electrónica Ajustable	
R	94-01	DODGE PICKUP 1/2 TON, RAM 1500 Todos	
R	94-02	PICKUP 1 TON, RAM 3500 4x2 Tracción trasera Exc. Eje Delantero Rígido	
R	94-02	PICKUP 3/4 TON, RAM 2500 4x4, GAS Exc. PBV 8600 #	
R	94-02	PICKUP 3/4 TON, RAM 2500 4x2 Tracción trasera	
R	95-96	PICKUP 3/4 TON, RAM 2500 4x4, CNG Exc. PBV 8600 #	
R	99-06	GMC SIERRA 1500 4x2 Tracción trasera Exc. Suspensión Electrónica Ajustable	
R	07	SIERRA 1500 CLASSIC 4x2 Tracción trasera Exc. Suspensión Electrónica Ajustable	
58673	W	142731	
F	94-01	DODGE PICKUP 1/2 TON, RAM 1500 4x4	
F	94-02	PICKUP 3/4 TON, RAM 2500 4x4, GAS Exc. PBV 8600 #	
F	95-96	PICKUP 3/4 TON, RAM 2500 4x4, CNG Exc. PBV 8600 #	
58674	W	142731	
F	94-02	DODGE PICKUP 1 TON, RAM 3500 4x4	
F	94-02	PICKUP 1 TON, RAM 3500 4x2 Tracción trasera Eje Delantero Rígido	
F	94-02	PICKUP 3/4 TON, RAM 2500 4x4, DIESEL PBV 8800	
58675	W		
R	94-02	DODGE PICKUP 1 TON, RAM 3500 4x4	
R	94-02	PICKUP 1 TON, RAM 3500 4x2 Tracción trasera Eje Delantero Rígido	
R	94-02	PICKUP 3/4 TON, RAM 2500 4x4, DIESEL PBV 8800	
58714	D	142731	
F	97-02	FORD EXPEDITION 4x2 Tracción trasera Exc. Nivelación Nuemática Delantera	
F	97-04	PICKUP 1/2 TON, F-150 4x2 Tracción trasera	
F	96-99	PICKUP 3/4 TON, F-250 / SUPERDUTY 4x2 Tracción trasera Hasta PBV 8500#	
F	98-02	LINCOLN NAVIGATOR 4x2 Tracción trasera	
58715	W	142700	
R	97-04	FORD LOBO PICK UP	

Amortiguadores LTV

Amort.	POP	No. Alternativo	Montaje Accesorio
Pos.	Año	Aplicación	
58715	W	-continued	
R	97-04	PICKUP 1/2 TON, F-150 4x4 Exc. PBV 7700#	
R	97-99	PICKUP 3/4 TON, F-250 / SUPERDUTY 4x4 Hasta PBV 8500#, Exc. Superduty	
58716	W	142731	
F	97-02	FORD EXPEDITION 4x4 Exc. Nivelación Nuemática Delantera	
F	97-04	LOBO PICK UP	
F	04	PICKUP 1/2 TON, F-150 4x4 Exc. PBV 7700#	
F	97-03	PICKUP 1/2 TON, F-150 4x4	
F	97-99	PICKUP 3/4 TON, F-250 / SUPERDUTY 4x4 Hasta PBV 8500#, Exc. Superduty	
58717	W		
R	97-02	FORD EXPEDITION Todos	
R	98-02	LINCOLN NAVIGATOR 4x2 Tracción trasera, Coil (FrontSpringType)	
58778	W	142700	
R	97-04	FORD LOBO PICK UP	
R	04	PICKUP 1/2 TON, F-150 4x2 Tracción trasera	
R	00-03	PICKUP 1/2 TON, F-150 Harley-Davidson Edition, 4x2 Tracción trasera	
R	99-03	PICKUP 1/2 TON, F-150 Lariat, 4x2 Tracción trasera	
R	99-03	PICKUP 1/2 TON, F-150 XL, 4x2 Tracción trasera	
R	99-03	PICKUP 1/2 TON, F-150 XLT, 4x2 Tracción trasera	
R	00	PICKUP 1/2 TON, F-150 Base, 4x2 Tracción trasera	
R	97-98	PICKUP 1/2 TON, F-150 4x2 Tracción trasera	
R	97-99	PICKUP 3/4 TON, F-250 / SUPERDUTY 4x2 Tracción trasera Hasta PBV 8500#	
58783	W	141665	
F	03-07	CHEVROLET CHEYENNE	
F	99-06	PICKUP 1/2 TON, SILVERADO 1500 4x2 Tracción trasera Suspensión Elec. Ajustable	
F	99-06	PICKUP 3/4 TON, SILVERADO 2500 4x2 Tracción trasera PBV 8600 Lb.; Exc. Suspensión Quadrasteer	
F	07	SILVERADO 1500 CLASSIC 4x2 Tracción trasera Exc. Suspensión Electrónica Ajustable	
F	99-06	GMC SIERRA 1500 4x2 Tracción trasera Exc. Suspensión Electrónica Ajustable	
F	07	SIERRA 1500 CLASSIC 4x2 Tracción trasera Exc. Suspensión Electrónica Ajustable	
58803	W	141665	
F	02-06	CHEVROLET AVALANCHE 1500 Todos Exc. Control de Manejo Electrónico	
F	03-07	CHEYENNE	
F	99-06	PICKUP 1/2 TON, SILVERADO 1500 4x4 Estilo Carrocería Clasica y Antigua, Exc. Suspensión Electrónica Ajustable	
F	07	SILVERADO 1500 CLASSIC 4x4 Exc. Suspensión Electrónica Ajustable	
F	00-06	SONORA Todos Exc. Suspensión Z55	
F	00-06	SUBURBAN 1/2 TON, 1500 Todos Exc. Suspensión Z55 Auto Ride	
F	02-06	TAHOE Todos Exc. Suspensión Z55 Auto Ride	
F	00-01	TAHOE Todos Estilo New Body, Exc. Suspensión Z55	
F	99-06	GMC SIERRA 1500 4x4 Estilo Carrocería Clasica y Antigua, Exc. Suspensión Electrónica Ajustable	
F	07	SIERRA 1500 HD CLASSIC 4x4 Exc. Suspensión Electrónica Ajustable	
F	00-06	YUKON Todos Exc. Suspensión Z55 Auto Ride	
F	00-06	YUKON XL 1/2 TON Todos Exc. Suspensión Z55 Auto Ride	

Lista numérica

Amort.	POP	No. Alternativo	Montaje Accesorio
Pos.	Año	Aplicación	
58807	D	142617	
F	99-12	FORD PICKUP 1 TON, F-350 / SUPERDUTY 4x2 Tracción trasera	
F	99-12	PICKUP 3/4 TON, F-250 / SUPERDUTY 4x2 Tracción trasera	
58808	D		
R	99-04	FORD PICKUP 1 TON, F-350 / SUPERDUTY 4x2 Tracción trasera	
R	99-04	PICKUP 3/4 TON, F-250 / SUPERDUTY 4x2 Tracción trasera	
58809	W		
F	99-04	FORD PICKUP 1 TON, F-350 / SUPERDUTY 4x4	
F	99-04	PICKUP 3/4 TON, F-250 / SUPERDUTY 4x4	
F	99-04	PICKUP, F-450 SUPERDUTY Todos	
F	99-04	PICKUP, F-550 SUPERDUTY Todos	
58810	D		
R	99-04	FORD PICKUP 1 TON, F-350 / SUPERDUTY 4x4	
R	99-04	PICKUP 3/4 TON, F-250 / SUPERDUTY 4x4	
58811	W		
R	99-04	FORD PICKUP, F-450 SUPERDUTY Todos	
R	99-04	PICKUP, F-550 SUPERDUTY Todos	
58812	W		
F	91-00	CHEVROLET PICKUP 1 TON, C35/3500 Cab & Chassis Eje Delantero Rígido HD	
F	91-00	GMC PICKUP 1 TON, C35/3500 Cab & Chassis Eje Delantero Rígido HD	
58817	D	141665	
F	02-06	CHEVROLET AVALANCHE 2500 Todos Exc. Control de Manejo Electrónico	
F	05-06	PICKUP 1/2 TON, SILVERADO 1500 HD Todos	
F	01-03	PICKUP 1/2 TON, SILVERADO 1500 HD Todos	
F	01-09	PICKUP 1 TON, SILVERADO 3500 Todos	
F	07-10	PICKUP 1 TON, SILVERADO 3500 HD Todos	
F	05-08	PICKUP 3/4 TON, SILVERADO 2500 Todos	
F	99-04	PICKUP 3/4 TON, SILVERADO 2500 4x4	
F	01-10	PICKUP 3/4 TON, SILVERADO 2500 HD Todos PBV 9200	
F	00-11	SUBURBAN 3/4 TON, 2500 Todos Exc. Suspensión Auto Ride Z55 y Quadrasteer	
F	05-06	GMC SIERRA 1500 HD Todos	
F	01-03	SIERRA 1500 HD Todos	
F	99-04	SIERRA 2500 Todos	
F	01-10	SIERRA 2500 HD Todos	
F	01-06	SIERRA 3500 Todos	
F	07-10	SIERRA 3500 HD Barra de Torsion (FrontSpringType)	
F	00-06	YUKON XL 3/4 TON Todos Exc. Sistema de Autonivelación NIVOMAT	
58901	W		
F	88-99	CHEVROLET PICKUP 1/2 TON, K15 / K1500 Todos	
F	95-00	TAHOE 4x4 Old Body Style	
F	88-99	GMC PICKUP 1/2 TON, K15 / K1500 Todos	
F	92-99	YUKON 4x4	
F	99	YUKON Denali	
58906	W		
F	87-91	CHEVROLET BLAZER 4x4 Automóvil Grande; Suspensión Quad Amortiguador Largo; Exc. Kit de Levantamiento	
F	81-86	BLAZER 4x4 Suspensión Quad Amortiguador Largo; Exc. Kit de Levantamiento	
F	81-86	PICKUP 1/2 TON, K10 Todos Suspensión Quad Amortiguador Largo; Exc. Kit de Levantamiento	
F	87	PICKUP 1/2 TON, V10 Todos Suspensión Quad Amortiguador Largo; Exc. Kit de Levantamiento	

Lista numérica

Amort.	POP	No. Alternativo	Montaje Accesorio
Pos.	Año	Aplicación	
58906	W	-continued	
F	81-86	PICKUP 3/4 TON, K20 Todos	Suspensión Quad Amortiguador Largo; Exc. Kit de Levantamiento
F	87	PICKUP 3/4 TON, V20 Todos	Suspensión Quad Amortiguador Largo; Exc. Kit de Levantamiento
F	81-86	SUBURBAN 1/2 TON, K10 Todos	Suspensión Quad Amortiguador Largo; Exc. Kit de Levantamiento
F	81-86	SUBURBAN 3/4 TON, K20 Todos	Suspensión Quad Amortiguador Largo; Exc. Kit de Levantamiento
F	87-88	SUBURBAN 3/4 TON, V20 Todos	Suspensión Quad Amortiguador Largo; Exc. Kit de Levantamiento
F	89-91	SUBURBAN 3/4 TON, V2500 Todos	Suspensión Quad Amortiguador Largo; Exc. Kit de Levantamiento
F	73-91	GMC JIMMY 4x4 Suspensión Quad Amortiguador Largo; Exc. Kit de Levantamiento	
F	81-86	PICKUP 1/2 TON, K15 / K1500	Todos Suspensión Quad Amortiguador Largo; Exc. Kit de Levantamiento
F	87	PICKUP 1/2 TON, V1500 Todos	Suspensión Quad Amortiguador Largo; Exc. Kit de Levantamiento
F	81-86	PICKUP 3/4 TON, K25 / K2500	Todos Suspensión Quad Amortiguador Largo; Exc. Kit de Levantamiento
F	87	PICKUP 3/4 TON, V2500 Todos	Suspensión Quad Amortiguador Largo; Exc. Kit de Levantamiento
F	81-86	SUBURBAN 1/2 TON, K15 / K1500	Todos Suspensión Quad Amortiguador Largo; Exc. Kit de Levantamiento
F	87-91	SUBURBAN 1/2 TON, V1500 Todos	Suspensión Quad Amortiguador Largo; Exc. Kit de Levantamiento
F	81-86	SUBURBAN 3/4 TON, K25 / K2500	Todos Suspensión Quad Amortiguador Largo; Exc. Kit de Levantamiento
F	87-91	SUBURBAN 3/4 TON, V2500 Todos	Suspensión Quad Amortiguador Largo; Exc. Kit de Levantamiento
58908	W		
F	87-91	CHEVROLET BLAZER 4x4 Automóvil Grande; Suspensión Quad Amortiguador Corto; Exc. Kit de Levantamiento	
F	81-86	BLAZER 4x4 Suspensión Quad Amortiguador Corto; Exc. Kit de Levantamiento	
F	81-86	PICKUP 1/2 TON, K10 Todos	Suspensión Quad Amortiguador Corto; Exc. Kit de Levantamiento
F	87	PICKUP 1/2 TON, V10 Todos	Suspensión Quad Amortiguador Corto; Exc. Kit de Levantamiento
F	81-86	PICKUP 3/4 TON, K20 Todos	Suspensión Quad Amortiguador Corto; Exc. Kit de Levantamiento
F	87	PICKUP 3/4 TON, V20 Todos	Suspensión Quad Amortiguador Corto; Exc. Kit de Levantamiento
F	81-86	SUBURBAN 1/2 TON, K10 Todos	Suspensión Quad Amortiguador Corto; Exc. Kit de Levantamiento
F	81-86	SUBURBAN 3/4 TON, K20 Todos	Suspensión Quad Amortiguador Corto; Exc. Kit de Levantamiento
F	87-88	SUBURBAN 3/4 TON, V20 Todos	Suspensión Quad Amortiguador Corto; Exc. Kit de Levantamiento
F	89-91	SUBURBAN 3/4 TON, V2500 Todos	Suspensión Quad Amortiguador Corto; Exc. Kit de Levantamiento
F	73-91	GMC JIMMY 4x4 Suspensión Quad Amortiguador Corto; Exc. Kit de Levantamiento	
F	81-86	PICKUP 1/2 TON, K15 / K1500	Todos Suspensión Quad Amortiguador Corto; Exc. Kit de Levantamiento
F	87	PICKUP 1/2 TON, V1500 Todos	Suspensión Quad Amortiguador Corto; Exc. Kit de Levantamiento

Amortiguadores LTV, Amortiguadores ProGuard

Amort.	POP	No. Alternativo	Montaje Accesorio
Pos.	Año	Aplicación	
58908	W	-continued	
F	81-86	PICKUP 3/4 TON, K25 / K2500	Todos Suspensión Quad Amortiguador Corto; Exc. Kit de Levantamiento
F	87	PICKUP 3/4 TON, V2500 Todos	Suspensión Quad Amortiguador Corto; Exc. Kit de Levantamiento
F	81-86	SUBURBAN 1/2 TON, K15 / K1500	Todos Suspensión Quad Amortiguador Corto; Exc. Kit de Levantamiento
F	87-91	SUBURBAN 1/2 TON, V1500 Todos	Suspensión Quad Amortiguador Corto; Exc. Kit de Levantamiento
F	81-86	SUBURBAN 3/4 TON, K25 / K2500	Todos Suspensión Quad Amortiguador Corto; Exc. Kit de Levantamiento
F	87-91	SUBURBAN 3/4 TON, V2500 Todos	Suspensión Quad Amortiguador Corto; Exc. Kit de Levantamiento
58929	D	140780	
F	90	FORD BRONCO II Todos	
F	91-94	EXPLORER Todos	
F	90-97	RANGER Todos	
F	92-11	VAN 1/2 TON, ECONOLINE / CLUB WAGON Todos	
F	94-97	MAZDA B2300 Todos	
F	91-94	NAVAJO Todos	
58930	W		
R	02-10	CADILLAC ESCALADE Todos	
R	07-11	CHEVROLET AVALANCHE 1500 Todos Exc. Suspensión Z55 o ZW7	
R	02-06	AVALANCHE 1500 Todos Exc. Control de Manejo Electrónico	
R	02-06	AVALANCHE 2500 Todos Exc. Control de Manejo Electrónico	
R	00-06	SONORA Todos Exc. Suspensión Z55	
R	09-11	SUBURBAN 1/2 TON, 1500 Todos Exc. Suspensión Z55 Auto Ride	
R	08	SUBURBAN 1/2 TON, 1500 Todos Exc. Suspensión Z55 o ZW7	
R	00-07	SUBURBAN 1/2 TON, 1500 Todos Exc. Suspensión Z55 Auto Ride	
R	00-11	SUBURBAN 3/4 TON, 2500 Todos Exc. Suspensión Auto Ride Z55 y Quadrateer	
R	02-11	TAHOE Todos Exc. Suspensión Z55 o ZW7	
R	00-01	TAHOE Todos Estilo New Body, Exc. Suspensión Z55	
R	00-11	GMC YUKON Todos Exc. Suspensión Z55 o ZW7	
R	00-11	YUKON XL 1/2 TON Todos Exc. Suspensión Z55 Auto Ride	
R	00-11	YUKON XL 3/4 TON Todos Exc. Sistema de Autonivelación NIVOMAT	
58943	D		
R	11-13	CHEVROLET PICKUP 1 TON, SILVERADO 3500 Todos	
R	11-13	PICKUP 1 TON, SILVERADO 3500 HD Todos	
R	11-13	PICKUP 3/4 TON, SILVERADO 2500 Todos	
R	11-13	PICKUP 3/4 TON, SILVERADO 2500 HD Todos	
R	11-13	GMC SIERRA 2500 HD Todos	
R	11-13	SIERRA 3500 HD Todos	
58944	D		
F	10-12	FORD F-550 Todos	
F	11-12	PICKUP, F-450 SUPERDUTY Todos	
F	07-09	PICKUP, F-450 SUPERDUTY Todos	
58945	D		
R	10-12	FORD F-550 Todos Crew Cab	
R	11-12	PICKUP, F-450 SUPERDUTY Todos Crew Cab	
R	07-09	PICKUP, F-450 SUPERDUTY Todos Crew Cab	
Amortiguadores ProGuard			
61500	A		
R	75-80	CHEVROLET LUV PICKUP Todos	
R	72-74	LUV PICKUP Todos	
F	55-56	PICKUP 3800	
F	55	PICKUP 3100	
R	79-82	DODGE D50 4x2 Tracción trasera	

Lista numérica

Amort.	POP	No. Alternativo	Montaje Accesorio
Pos.	Año	Aplicación	
61500	A	-continued	
R	87-93	PICKUP, RAM 50 4x2 Tracción trasera	
R	83-86	PICKUP, RAM 50 Todos	
R	55	FORD F SERIES Todos F-100	
F	48-52	F SERIES Todos F-1, F-2 y F-3	
F	76	PICKUP P350 Todos	
F	68-75	PICKUP P350 Todos Hasta PBV 8000#	
F	75-76	PICKUP P400 Todos Hasta PBV 8000#	
R	68	INTERNATIONAL 908C Todos	
R	68	1000C Todos	
F	68	1100C Todos Exc. Travelette c/ base de rueda de 166"	
R	68	1100C Todos Exc. Travelette c/ base de rueda de 166"	
F	68	1200C Todos Exc. Travelette c/ base de rueda de 166"	
R	68	1200C Todos Exc. Travelette c/ base de rueda de 166"	
F	68	1300C Todos Exc. Travelette c/ base de rueda de 166"	
R	68	1300C Todos Exc. Travelette c/ base de rueda de 166"	
R	68-72	M1100 / M1200 Todos	
R	69	M1400 Todos	
R	72-83	JEEP CJ5 Todos Exc. Kit de Levantamiento	
R	66-71	CJ5 Todos	
R	72-75	CJ6 Todos Exc. Kit de Levantamiento	
R	66-71	CJ6 Todos	
R	68-75	CJ7	
R	76-86	CJ7 Todos Exc. Kit de Levantamiento	
R	66-74	DJ5 Todos Exc. Kit de Levantamiento	
R	66-68	DJ6 Todos	
R	57-60	FC150 Todos	
F	63-65	FC170 Todos	
R	63-65	FC170 Todos	
R	63-66	GLADIATOR Todos Suspensión Delantera Independiente	
R	83	J100	
F	80-82	J100	
R	68-69	J162	
R	65	J162	
R	65-70	J164	
R	67-70	J164V	
R	65	J164V	
R	71	J262S	
R	68-69	J262S	
R	67	J264D	
R	65	J264D	
R	65-73	J364R	
R	70-73	JEEPSTER Todos	
R	81-85	SCRAMBLER / CJ8 Todos	
R	61-67	UNIVERSAL Todos	
R	86-87	MAZDA B2000 4x2 Tracción trasera	
R	87-93	B2200 4x2 Tracción trasera	
R	87-93	B2600 4x2 Tracción trasera	
R	95-96	MITSUBISHI MIGHTY MAX Todos	
R	83-94	MIGHTY MAX 4x2 Tracción trasera	
R	87-90	VAN Todos	
R	98-04	NISSAN FRONTIER 4x2 Tracción trasera Exc. Desert Runner	
R	87-93	ICHIVAN	
R	65-12	PICKUP	
R	87-94	PICKUP 4x2 Tracción trasera	
R	86	PICKUP 4x2 Tracción trasera Fabricado desde 8/86	
R	00-13	URVAN Todos	
R	79-82	PLYMOUTH ARROW PICKUP Todos	
R	69-74	TOYOTA LAND CRUISER Todos Exc. Wagon	
R	67-68	LAND CRUISER Todos	
R	85-95	PICKUP 4x2 Tracción trasera Exc. 1 Ton	
R	84	PICKUP 4x2 Tracción trasera	
R	75-83	PICKUP 4x2 Tracción trasera Mojave	
R	70-74	PICKUP Todos 4x2 Tracción trasera; Mojave	
R	04	TACOMA Base, 4x2 Tracción trasera	
R	95-03	TACOMA DLX, 4x2 Tracción trasera	
R	98-00	TACOMA SR5, 4x4	
R	84-88	VAN Leaf (RearSpringType)	
R	88	VAN WAGON Todos	
61501	A	140857	
F	81-82	CHEVROLET LUV PICKUP 4x2 Tracción trasera	

Lista numérica

Amort.	POP	No. Alternativo	Montaje Accesorio
Pos.	Año	Aplicación	
61501	A	-continued	140857
F	81-95	ISUZU PICKUP 4x2 Tracción trasera	
F	69-72	NISSAN 521 PICKUP Todos	
F	72-79	620 PICKUP Todos	
F	80-86	720 PICKUP Todos	
F	65-12	PICKUP	
61503	D		141277
R	90-96	CHEVROLET LUMINA APV Todos	
R	90-96	OLDSMOBILE SILHOUETTE Todos	
R	90-96	PONTIAC TRANS SPORT Todos	
61504	B		140455
F	05	CHEVROLET BLAZER Base, 4x2 Tracción trasera	
F	96-04	BLAZER LS, 4x2 Tracción trasera	
F	95-02	BLAZER LT, 4x2 Tracción trasera	
F	95-99	BLAZER Base, 4x2 Tracción trasera	
F	95-97	BLAZER Deluxe, 4x2 Tracción trasera	
F	83-94	BLAZER, S MODELS 4x2 Tracción trasera	
F	68-87	EL CAMINO Todos	
F	94-03	S10 LS, 4x2 Tracción trasera	
F	82-03	S10 Base, 4x2 Tracción trasera	
F	92-93	S10 EL, 4x2 Tracción trasera	
F	83-92	S10 Tahoe, 4x2 Tracción trasera	
F	88-90	S10 Durango, 4x2 Tracción trasera	
F	82-86	S10 Durango, 4x2 Tracción trasera	
F	72-82	FORD COURIER Todos	
F	92-04	GMC JIMMY 4x2 Tracción trasera	
F	83-91	S15 JIMMY 4x2 Tracción trasera	
F	04	SONOMA / S15 Todos 4x2 Tracción trasera	
F	82-03	SONOMA / S15 4x2 Tracción trasera	
F	71-87	SPRINT / CABALLERO Todos	
F	96-00	ISUZU HOMBRE 4x2 Tracción trasera Exc. Chasis Deportivo	
F	72-76	MAZDA B1600 Todos	
F	77-78	B1800 Todos	
F	79-84	B2000 Todos	
F	82-84	B2200 Todos	
F	75-83	TOYOTA PICKUP 4x2 Tracción trasera Mojave	
F	70-74	PICKUP Todos 4x2 Tracción trasera; Mojave	
61505	D		140524
R	69-72	NISSAN 521 PICKUP Todos	
R	72-79	620 PICKUP Todos	
R	86	720 PICKUP 4x2 Tracción trasera Fabricado antes de 8/86	
R	82-85	720 PICKUP 4x2 Tracción trasera	
R	80-81	720 PICKUP Todos	
61506	C		141137
R	81-82	CHEVROLET LUV PICKUP Todos	
R	87-89	DODGE RAIDER 2.6L 4Cyl L (156) 2.6L 4 Cyl	
F	61-67	FORD ECONOLINE Todos	
R	89-94	ISUZU AMIGO Todos	
R	81-95	PICKUP Todos	
R	84-86	TROOPER Todos	
R	86-92	JEEP COMANCHE Todos	
R	83-88	MITSUBISHI MONTERO 2.6L 4Cyl L (156)	
R	97-99	MONTERO SPORT Todos	
R	82-86	NISSAN 720 PICKUP 4x4	
R	00-04	FRONTIER Crew Cab Pickup, 4x2 Tracción trasera con Desert Runner	
R	98-04	FRONTIER 4x4	
R	98-99	FRONTIER 4x2 Tracción trasera Crew Cab con Desert Runner	
R	87-95	PATHFINDER Todos Exc. Suspensión Electrónica Ajustable	
R	65-94	PICKUP	
R	00-04	XTERRA Todos	
R	84-87	TOYOTA LAND CRUISER FJ60 (Código plataforma del fabricante), Sport Utility	
R	80-83	LAND CRUISER Todos	
R	79	LAND CRUISER FJ40 (Código plataforma del fabricante)	
R	79	LAND CRUISER FJ55 (Código plataforma del fabricante), Sport Utility	
R	76-78	LAND CRUISER Todos	
R	75	LAND CRUISER FJ40 (Código plataforma del fabricante) Fab. desde 1/75	
R	75	LAND CRUISER FJ55 (Código plataforma del fabricante), Sport Utility Fab. desde 1/75	
R	85-92	PICKUP 4x2 Tracción trasera 1 Ton	
R	80-83	PICKUP 4x4 Exc. Kit de Levantamiento	

Amortiguadores ProGuard

Amort.	POP	No. Alternativo	Montaje Accesorio
Pos.	Año	Aplicación	
61506	C	-continued	141137
R	93-98	T100 4x2 Tracción trasera	
61507	X		141349,140169
F	88-90	TOYOTA LAND CRUISER Todos	
F	81-87	LAND CRUISER FJ60 (Código plataforma del fabricante), Sport Utility	
F	80	LAND CRUISER Todos	
61508	C		140857
F	81-82	CHEVROLET LUV PICKUP 4x4	
F	75-80	LUV PICKUP Todos	
F	72-74	LUV PICKUP Todos	
F	89-94	ISUZU AMIGO Todos	
F	81-95	PICKUP 4x4	
F	84-86	TROOPER Todos	
F	98-04	NISSAN FRONTIER 4x2 Tracción trasera Exc. Desert Runner	
F	65-93	PICKUP	
61509	C		140455
F	93-95	TOYOTA PICKUP 4x2 Tracción trasera Exc. 1 Ton	
F	85-92	PICKUP 4x2 Tracción trasera 1 Ton	
F	84	PICKUP 4x2 Tracción trasera	
F	93-98	T100 4x2 Tracción trasera	
61510	B		140149
R	84-89	TOYOTA 4RUNNER Todos	
R	84-95	PICKUP 4x4 Exc. Kit de Levantamiento	
R	01-04	TACOMA S-Runner	
R	04	TACOMA Base, 4x4	
R	95-03	TACOMA DLX, 4x4	
R	98-00	TACOMA Limited	
61511	D		
R	87-96	DODGE DAKOTA 4x2 Tracción trasera	
61512	C		140126
F	87-04	DODGE DAKOTA 4x2 Tracción trasera	
F	99-03	DURANGO 4x2 Tracción trasera	
61516	D		
F	87-91	CHEVROLET BLAZER 4x4 Automóvil Grande; Suspensión Quad Amortiguador Corto; Exc. Kit de Levantamiento	
F	81-86	BLAZER 4x4 Suspensión Quad Amortiguador Corto; Exc. Kit de Levantamiento	
F	75-80	BLAZER 4x4 Exc. Suspensión Quad y Kit de Levantamiento	
F	73-74	BLAZER 4x4 Exc. Kit de Levantamiento	
F	69-72	BLAZER 4x4	
F	81-86	PICKUP 1/2 TON, K10 Todos Suspensión Quad Amortiguador Corto; Exc. Kit de Levantamiento	
F	74-80	PICKUP 1/2 TON, K10 Todos Exc. Kit de Levantamiento	
F	73	PICKUP 1/2 TON, K10 Todos Exc. Suspensión Quad y Kit de Levantamiento	
F	69-72	PICKUP 1/2 TON, K10 Todos Exc. Kit de Levantamiento	
F	88	PICKUP 1/2 TON, K15 / K1500 Todos Suspensión Quad Amortiguador Corto; Exc. Kit de Levantamiento	
F	87	PICKUP 1/2 TON, V10 Todos Suspensión Quad Amortiguador Corto; Exc. Kit de Levantamiento	
F	81-86	PICKUP 3/4 TON, K20 Todos Suspensión Quad Amortiguador Corto; Exc. Kit de Levantamiento	
F	69-80	PICKUP 3/4 TON, K20 Todos Exc. Kit de Levantamiento	
F	87	PICKUP 3/4 TON, V20 Todos Exc. Suspensión Quad y Kit de Levantamiento	
F	81-86	SUBURBAN 1/2 TON, K10 Todos Suspensión Quad Amortiguador Corto; Exc. Kit de Levantamiento	
F	69-80	SUBURBAN 1/2 TON, K10 Todos Exc. Kit de Levantamiento	
F	87-88	SUBURBAN 1/2 TON, V10 Todos Suspensión Quad Amortiguador Corto; Exc. Kit de Levantamiento	
F	89-91	SUBURBAN 1/2 TON, V1500 Todos Exc. Suspensión Quad y Kit de Levantamiento	

Lista numérica

Amort.	POP	No. Alternativo	Montaje Accesorio
Pos.	Año	Aplicación	
61516	D	-continued	
F	81-86	SUBURBAN 3/4 TON, K20 Todos Suspensión Quad Amortiguador Corto; Exc. Kit de Levantamiento	
F	69-80	SUBURBAN 3/4 TON, K20 Todos Exc. Kit de Levantamiento	
F	87-88	SUBURBAN 3/4 TON, V20 Todos Suspensión Quad Amortiguador Corto; Exc. Kit de Levantamiento	
F	89-91	SUBURBAN 3/4 TON, V2500 Todos Suspensión Quad Amortiguador Corto; Exc. Kit de Levantamiento	
F	70-91	GMC JIMMY 4x4 Exc. Suspensión Quad y Kit de Levantamiento	
F	69-86	PICKUP 1/2 TON, K15 / K1500 Todos Exc. Suspensión Quad y Kit de Levantamiento	
F	87	PICKUP 1/2 TON, V1500 Todos Suspensión Quad Amortiguador Corto; Exc. Kit de Levantamiento	
F	69-86	PICKUP 3/4 TON, K25 / K2500 Todos Exc. Suspensión Quad y Kit de Levantamiento	
F	87	PICKUP 3/4 TON, V2500 Todos Suspensión Quad Amortiguador Corto; Exc. Kit de Levantamiento	
F	69-86	SUBURBAN 1/2 TON, K15 / K1500 Todos Exc. Suspensión Quad y Kit de Levantamiento	
F	87-91	SUBURBAN 1/2 TON, V1500 Todos Suspensión Quad Amortiguador Corto; Exc. Kit de Levantamiento	
F	69-86	SUBURBAN 3/4 TON, K25 / K2500 Todos Exc. Suspensión Quad y Kit de Levantamiento	
F	87-91	SUBURBAN 3/4 TON, V2500 Todos Suspensión Quad Amortiguador Corto; Exc. Kit de Levantamiento	
61517	D		
F	71-95	CHEVROLET VAN 1/2 TON, G / EXPRESS Todos	
F	70	VAN 1/2 TON, G / EXPRESS Todos Suspensión Delantera Independiente	
F	78-96	VAN 1 TON, G / EXPRESS Todos	
F	75	VAN 1 TON, G / EXPRESS 146.0 (WheelBase)	
F	71-74	VAN 1 TON, G / EXPRESS Todos	
F	78-95	VAN 3/4 TON, G / EXPRESS Todos Exc. PBV 8600 #	
F	71-77	VAN 3/4 TON, G / EXPRESS Todos	
F	70	VAN 3/4 TON, G / EXPRESS Todos Suspensión Delantera Independiente	
F	71-95	GMC VAN 1/2 TON, G / SAVANNA Todos	
F	70	VAN 1/2 TON, G / SAVANNA Todos Suspensión Delantera Independiente	
F	76-95	VAN 1 TON, G / SAVANNA Todos	
F	75	VAN 1 TON, G / SAVANNA 110.0 (WheelBase)	
F	75	VAN 1 TON, G / SAVANNA 125.0 (WheelBase)	
F	71-74	VAN 1 TON, G / SAVANNA Todos	
F	78-95	VAN 3/4 TON, G / SAVANNA Todos Exc. PBV 8600 #	
F	71-77	VAN 3/4 TON, G / SAVANNA Todos	
F	70	VAN 3/4 TON, G / SAVANNA Todos Suspensión Delantera Independiente	
61518	D		140126
R	79-81	FORD B100	
R	82-85	B150	
R	75-78	B150	
R	66	BRONCO Todos Toda la serie #830000	
R	75-79	PICKUP 1/2 TON, F-100 4x2 Tracción trasera	
R	75-79	PICKUP 1/2 TON, F-150 4x2 Tracción trasera	
R	75-79	PICKUP 1 TON, F-350 / SUPERDUTY Extended Cab Pickup, 4x2 Tracción trasera	
R	75-79	PICKUP 3/4 TON, F-250 / SUPERDUTY Cab & Chassis, 4x2 Tracción trasera	
R	75-79	PICKUP 3/4 TON, F-250 / SUPERDUTY Standard Cab Pickup, 4x2 Tracción trasera	
R	75-91	VAN 1/2 TON, ECONOLINE / CLUB WAGON Todos	
F	71-80	INTERNATIONAL SCOUT II Todos	
61519	D		141137
R	73-74	FORD B100	

Lista numérica

Amort.	POP	No. Alternativo	Montaje Accesorio
Pos.	Año	Aplicación	
61519	D	-continued	141137
R	78-79	BRONCO Todos Exc. Kit de Levantamiento	
R	66-77	BRONCO Todos Desde Serie #830001; Exc. Kit de Levantamiento	
R	65-78	F-100	
R	67-78	F-350 PICKUP	
R	75-79	PICKUP 1 TON, F-350 / SUPERDUTY Standard Cab Pickup, 4x2 Tracción trasera	
R	75-79	PICKUP 3/4 TON, F-250 / SUPERDUTY Extended Cab Pickup, 4x2 Tracción trasera	
R	69-74	VAN 1/2 TON, ECONOLINE / CLUB WAGON Todos	
R	69-74	VAN 1 TON, ECONOLINE / CLUB WAGON / SUPERDUTY Todos	
R	69-74	VAN 3/4 TON, ECONOLINE / CLUB WAGON / SUPERDUTY Todos	
R	76-83	JEEP CHEROKEE Todos	
F	74-83	CHEROKEE Todos	
F	82-83	CJ5 Todos Exc. Kit de Levantamiento	
F	82-86	CJ7 Todos Exc. Kit de Levantamiento	
R	67	GLADIATOR Todos	
F	84-91	GRAND WAGONEER Todos	
R	84-91	GRAND WAGONEER Todos	
F	74-88	J10 PICKUP Todos	
R	74-88	J10 PICKUP Todos	
F	74-88	J20 PICKUP Todos	
R	74-88	J20 PICKUP Todos	
F	84-86	J100	
R	68-73	J2500 PICKUP Todos	
F	82-85	SCRAMBLER / CJ8 Todos	
R	76-83	WAGONEER Todos	
F	74-83	WAGONEER Todos	
61520	A		140780
F	82-85	FORD B150	
F	92	B200	
F	97	BRONCO	
F	80-96	BRONCO Todos Con o sin Suspensión Quad detrás del Eje Delantero; Exc. Kit de Levantamiento	
F	89	BRONCO II Todos Fab. hasta 2/89; Vehículos con perno 10mm y 12mm en montaje inferior trasero	
F	84-88	BRONCO II Todos Con Perno de 10mm en Montaje Inferior Trasero	
F	86-90	F-200	
F	99-00	F-350 PICKUP	
F	86-97	P350 MICROBUS	
F	80-83	PICKUP 1/2 TON, F-100 4x2 Tracción trasera	
F	80-96	PICKUP 1/2 TON, F-150 4x4 Con o sin Suspensión Quad detrás del Eje Delantero; Exc. Kit de Levantamiento	
F	80-96	PICKUP 1/2 TON, F-150 4x2 Tracción trasera	
F	80-97	PICKUP 1 TON, F-350 / SUPERDUTY 4x2 Tracción trasera	
F	97	PICKUP 3/4 TON, F-250 / SUPERDUTY 4x2 Tracción trasera PBV arriba de 8500#	
F	80-96	PICKUP 3/4 TON, F-250 / SUPERDUTY 4x2 Tracción trasera	
F	87-89	RANGER Todos Exc. Opción High Ryder	
F	83-86	RANGER Todos	
F	02-06	NISSAN URVAN Todos	
61521	C		140780
F	85-91	FORD B200	
F	78-79	BRONCO Todos Suspensión Quad; detrás del Eje Delantero; Exc. Kit de Levantamiento	
F	66-77	BRONCO Todos Desde Serie #830001; Exc. Kit de Levantamiento	
F	75-79	PICKUP 1/2 TON, F-100 4x2 Tracción trasera	
F	75-79	PICKUP 1/2 TON, F-150 4x2 Tracción trasera	
F	75-79	PICKUP 1 TON, F-350 / SUPERDUTY 4x2 Tracción trasera	
F	75-79	PICKUP 3/4 TON, F-250 / SUPERDUTY 4x2 Tracción trasera	
F	75-91	VAN 1 TON, ECONOLINE / CLUB WAGON / SUPERDUTY Todos Exc. Conversión Motorhome	
F	75-91	VAN 3/4 TON, ECONOLINE / CLUB WAGON / SUPERDUTY Todos	

Amortiguadores ProGuard

Amort.	POP	No. Alternativo	Montaje Accesorio
Pos.	Año	Aplicación	
61522	D		
F	87-91	CHEVROLET BLAZER 4x4 Automóvil Grande; Suspensión Quad Amortiguador Largo; Exc. Kit de Levantamiento	
F	81-86	BLAZER 4x4 Suspensión Quad Amortiguador Largo; Exc. Kit de Levantamiento	
F	81-86	PICKUP 1/2 TON, K10 Todos Suspensión Quad Amortiguador Largo; Exc. Kit de Levantamiento	
F	88	PICKUP 1/2 TON, K15 / K1500 Todos Suspensión Quad Amortiguador Largo; Exc. Kit de Levantamiento	
F	87	PICKUP 1/2 TON, V10 Todos Suspensión Quad Amortiguador Largo; Exc. Kit de Levantamiento	
F	81-86	PICKUP 3/4 TON, K20 Todos Suspensión Quad Amortiguador Largo; Exc. Kit de Levantamiento	
F	87	PICKUP 3/4 TON, V20 Todos Suspensión Quad Amortiguador Largo; Exc. Kit de Levantamiento	
F	81-86	SUBURBAN 1/2 TON, K10 Todos Suspensión Quad Amortiguador Largo; Exc. Kit de Levantamiento	
F	87-88	SUBURBAN 1/2 TON, V10 Todos Suspensión Quad Amortiguador Largo; Exc. Kit de Levantamiento	
F	81-86	SUBURBAN 3/4 TON, K20 Todos Suspensión Quad Amortiguador Largo; Exc. Kit de Levantamiento	
F	87-88	SUBURBAN 3/4 TON, V20 Todos Suspensión Quad Amortiguador Largo; Exc. Kit de Levantamiento	
F	89-91	SUBURBAN 3/4 TON, V2500 Todos Suspensión Quad Amortiguador Largo; Exc. Kit de Levantamiento	
R	78-95	VAN 1/2 TON, G / EXPRESS Todos	
R	78-95	VAN 1 TON, G / EXPRESS Cutaway Van	
R	78-95	VAN 3/4 TON, G / EXPRESS Todos Exc. PBV 8600 #	
R	84-86	DODGE MINI RAM Todos	
R	99-03	VAN 1/2 TON, A / B SERIES / RAM 109.3 (WheelBase) Exc. PBV 7000#	
R	81-98	VAN 1/2 TON, A / B SERIES / RAM 109.6 (WheelBase) Exc. PBV 7000#	
R	71-80	VAN 1/2 TON, A / B SERIES / RAM Todos	
R	99-03	VAN 1 TON, A / B SERIES / RAM Todos	
R	95-98	VAN 1 TON, A / B SERIES / RAM Todos Exc. Eje Delantero 4000#	
R	71-94	VAN 1 TON, A / B SERIES / RAM Todos	
R	71-03	VAN 3/4 TON, A / B SERIES / RAM Todos	
R	74-80	VAN, CB300 Todos	
F	73-91	GMC JIMMY 4x4 Suspensión Quad Amortiguador Largo; Exc. Kit de Levantamiento	
F	81-86	PICKUP 1/2 TON, K15 / K1500 Todos Suspensión Quad Amortiguador Largo; Exc. Kit de Levantamiento	
F	87	PICKUP 1/2 TON, V1500 Todos Suspensión Quad Amortiguador Largo; Exc. Kit de Levantamiento	
F	81-86	PICKUP 3/4 TON, K25 / K2500 Todos Suspensión Quad Amortiguador Largo; Exc. Kit de Levantamiento	
F	87	PICKUP 3/4 TON, V2500 Todos Suspensión Quad Amortiguador Largo; Exc. Kit de Levantamiento	
F	81-86	SUBURBAN 1/2 TON, K15 / K1500 Todos Suspensión Quad Amortiguador Largo; Exc. Kit de Levantamiento	
F	87-91	SUBURBAN 1/2 TON, V1500 Todos Suspensión Quad Amortiguador Largo; Exc. Kit de Levantamiento	
F	81-86	SUBURBAN 3/4 TON, K25 / K2500 Todos Suspensión Quad Amortiguador Largo; Exc. Kit de Levantamiento	
F	87-91	SUBURBAN 3/4 TON, V2500 Todos Suspensión Quad Amortiguador Largo; Exc. Kit de Levantamiento	
R	78-95	VAN 1/2 TON, G / SAVANNA Todos	
R	85-96	VAN 1 TON, G / SAVANNA Extended Cargo Van	

Lista numérica

Amort.	POP	No. Alternativo	Montaje Accesorio
Pos.	Año	Aplicación	
61522	D	-continued	
R	85-96	VAN 1 TON, G / SAVANNA Extended Passenger Van	
R	79-96	VAN 1 TON, G / SAVANNA Standard Cargo Van	
R	79-96	VAN 1 TON, G / SAVANNA Standard Passenger Van	
R	78	VAN 1 TON, G / SAVANNA Cutaway Van	
R	78-95	VAN 3/4 TON, G / SAVANNA Todos Exc. PBV 8600 #	
R	74-83	PLYMOUTH VAN 1/2 TON, PB SERIES Todos	
R	74-83	VAN 1 TON, PB SERIES Todos	
R	74-83	VAN 3/4 TON, PB SERIES Todos	
61523	C		140126
F	84-86	DODGE MINI RAM Todos	
F	70-93	PICKUP 1/2 TON, D100 SERIES Todos	
F	72-93	PICKUP 3/4 TON, D200 SERIES Todos Exc. Paquete HD	
F	95-96	RAMCHARGER 4x2 Tracción trasera	
F	75-93	RAMCHARGER 4x2 Tracción trasera	
F	99-03	VAN 1/2 TON, A / B SERIES / RAM 109.3 (WheelBase) Exc. PBV 7000#	
F	81-98	VAN 1/2 TON, A / B SERIES / RAM 109.6 (WheelBase) Exc. PBV 7000#	
F	71-80	VAN 1/2 TON, A / B SERIES / RAM Todos	
F	99-03	VAN 1 TON, A / B SERIES / RAM Todos	
F	71-98	VAN 1 TON, A / B SERIES / RAM Todos Exc. Eje Delantero 4000#	
F	71-03	VAN 3/4 TON, A / B SERIES / RAM Todos	
F	74-80	VAN, CB300 Todos Exc. Eje Delantero 4000#	
F	75-81	PLYMOUTH TRAILDUSTER 4x2 Tracción trasera	
F	74-83	VAN 1/2 TON, PB SERIES Todos	
F	74-83	VAN 1 TON, PB SERIES Todos Exc. Eje Delantero 4000#	
F	74-83	VAN 3/4 TON, PB SERIES Todos	
61524	C		140357
R	87-91	CHEVROLET BLAZER Todos Automóvil Grande; Exc. Suspensión Quad y Kit de Levantamiento	
R	73-86	BLAZER Todos Exc. Kit de Levantamiento	
R	73-78	CS1073	
R	73-86	PICKUP 1/2 TON, C10 Todos	
R	73-86	PICKUP 1/2 TON, K10 Todos Exc. Suspensión Quad y Kit de Levantamiento	
R	87	PICKUP 1/2 TON, R10 Todos	
R	87	PICKUP 1/2 TON, V10 Todos Exc. Suspensión Quad y Kit de Levantamiento	
R	75-86	PICKUP 3/4 TON, C20 Standard Cab Pickup	
R	73-74	PICKUP 3/4 TON, C20 Todos Standard Cab Pickup	
R	73-86	PICKUP 3/4 TON, K20 Todos Exc. Suspensión Quad y Kit de Levantamiento	
R	87	PICKUP 3/4 TON, R20 Standard Cab Pickup	
R	87	PICKUP 3/4 TON, V20 Todos Exc. Suspensión Quad y Kit de Levantamiento	
R	73-86	SUBURBAN 1/2 TON, C10 Todos	
R	73-86	SUBURBAN 1/2 TON, K10 Todos Exc. Suspensión Quad y Kit de Levantamiento	
R	87-88	SUBURBAN 1/2 TON, R10 Todos	
R	89-91	SUBURBAN 1/2 TON, R1500 Todos	
R	89-91	SUBURBAN 1/2 TON, V1500 Todos Exc. Suspensión Quad y Kit de Levantamiento	
R	73-86	SUBURBAN 3/4 TON, C20 Todos	
R	73-86	SUBURBAN 3/4 TON, K20 Todos Exc. Suspensión Quad y Kit de Levantamiento	
R	87-88	SUBURBAN 3/4 TON, R20 Todos	
R	89-91	SUBURBAN 3/4 TON, R2500 Todos	
R	87-88	SUBURBAN 3/4 TON, V20 Todos Exc. Suspensión Quad y Kit de Levantamiento	
R	89-91	SUBURBAN 3/4 TON, V2500 Todos Exc. Suspensión Quad y Kit de Levantamiento	

Lista numérica

Amort.	POP	No. Alternativo	Montaje Accesorio
Pos.	Año	Aplicación	
61524	C	-continued	140357
R 73		VAN 1/2 TON, P SERIES Todos	
R 73-78		VAN 3/4 TON, P SERIES Todos	
R 73-91		GMC JIMMY Todos Exc. Kit de Levantamiento	
R 73-86		PICKUP 1/2 TON, C15 / C1500 Todos	
R 73-86		PICKUP 1/2 TON, K15 / K1500 Todos Exc. Kit de Levantamiento	
R 87		PICKUP 1/2 TON, R1500 Todos	
R 87		PICKUP 1/2 TON, V1500 Todos Exc. Kit de Levantamiento	
R 75-86		PICKUP 3/4 TON, C25 / C2500 Cab & Chassis	
R 75-86		PICKUP 3/4 TON, C25 / C2500 Standard Cab Pickup	
R 73-74		PICKUP 3/4 TON, C25 / C2500 Todos Exc. Crew Cab y Bonus Cab	
R 73-86		PICKUP 3/4 TON, K25 / K2500 Todos Exc. Kit de Levantamiento	
R 88-89		PICKUP 3/4 TON, R2500 Todos Exc. Crew Cab y Bonus Cab	
R 87		PICKUP 3/4 TON, R2500 Cab & Chassis Exc. Crew Cab y Bonus Cab	
R 87		PICKUP 3/4 TON, R2500 Standard Cab Pickup Exc. Crew Cab y Bonus Cab	
R 87		PICKUP 3/4 TON, V2500 Todos Exc. Kit de Levantamiento	
R 73-86		SUBURBAN 1/2 TON, C15 / C1500 Todos	
R 73-86		SUBURBAN 1/2 TON, K15 / K1500 Todos Exc. Kit de Levantamiento	
R 87-91		SUBURBAN 1/2 TON, R1500 Todos	
R 87-91		SUBURBAN 1/2 TON, V1500 Todos Exc. Kit de Levantamiento	
R 75-86		SUBURBAN 3/4 TON, C25 / C2500 Todos	
R 73-74		SUBURBAN 3/4 TON, C25 / C2500 Todos Exc. Crew Cab y Bonus Cab	
R 73-86		SUBURBAN 3/4 TON, K25 / K2500 Todos Exc. Kit de Levantamiento	
R 87-91		SUBURBAN 3/4 TON, R2500 Todos	
R 87-91		SUBURBAN 3/4 TON, V2500 Todos Exc. Kit de Levantamiento	
R 73		VAN 1/2 TON, P SERIES Todos	
R 73-78		VAN 3/4 TON, P SERIES Todos	
61525	C		140702
F 75-84		CHEVROLET BLAZER 4x2 Tracción trasera	
F 69-74		BLAZER Todos 4x2 Tracción trasera	
F 65-66		C1405	
F 67		C3605	
F 65-67		C20905	
F 64-78		CS1073	
F 64-78		CS31003	
F 63-86		PICKUP 1/2 TON, C10 Todos	
F 87		PICKUP 1/2 TON, R10 Todos	
F 63-86		PICKUP 1 TON, C30 Todos	
F 88-91		PICKUP 1 TON, C35/3500 Cab & Chassis	
F 87-88		PICKUP 1 TON, R30 Todos	
F 89		PICKUP 1 TON, R3500 Standard Cab Pickup	
F 75-86		PICKUP 3/4 TON, C20 Crew Cab Pickup	
F 75-86		PICKUP 3/4 TON, C20 Standard Cab Pickup	
F 63-74		PICKUP 3/4 TON, C20 Todos	
F 88		PICKUP 3/4 TON, R20 Todos	
F 87		PICKUP 3/4 TON, R20 Crew Cab Pickup	
F 89		PICKUP 3/4 TON, R2500 Todos	
F 63-66		SUBURBAN 1/2 TON, 1500 Todos	
F 67-86		SUBURBAN 1/2 TON, C10 Todos	
F 87-88		SUBURBAN 1/2 TON, R10 Todos	
F 89-91		SUBURBAN 1/2 TON, R1500 Todos	
F 67-86		SUBURBAN 3/4 TON, C20 Todos	
F 87-88		SUBURBAN 3/4 TON, R20 Todos	
F 89-91		SUBURBAN 3/4 TON, R2500 Todos	
F 63-80		VAN 1/2 TON, P SERIES Todos	
F 68-90		VAN 1 TON, P SERIES Todos Exc. Chasis Motorhome	
F 68-89		VAN 3/4 TON, P SERIES Todos	
F 75-84		GMC JIMMY 4x2 Tracción trasera	
F 70-74		JIMMY Todos 4x2 Tracción trasera	
F 67-86		PICKUP 1/2 TON, C15 / C1500 Todos	
F 87		PICKUP 1/2 TON, R1500 Todos	
F 88-91		PICKUP 1 TON, C35/3500 Cab & Chassis Eje Delantero Rígido HD	
F 80-85		PICKUP 1 TON, C35/3500 Todos	
F 67-78		PICKUP 1 TON, C35/3500 Todos	

Amortiguadores ProGuard

Amort.	POP	No. Alternativo	Montaje Accesorio
Pos.	Año	Aplicación	
61525	C	-continued	140702
F 87-91		PICKUP 1 TON, R3500 Todos	
F 85-86		PICKUP 3/4 TON, C25 / C2500 Crew Cab Pickup	
F 75-86		PICKUP 3/4 TON, C25 / C2500 Cab & Chassis	
F 75-86		PICKUP 3/4 TON, C25 / C2500 Standard Cab Pickup	
F 75-83		PICKUP 3/4 TON, C25 / C2500 Crew Cab Pickup	
F 67-74		PICKUP 3/4 TON, C25 / C2500 Todos	
F 87-89		PICKUP 3/4 TON, R2500 Todos Exc. Crew Cab y Bonus Cab	
F 63-65		PICKUP 1000 SERIES Todos	
F 63-65		PICKUP 1500 SERIES Todos	
F 75-86		SUBURBAN 1/2 TON, C15 / C1500 Todos	
F 68-74		SUBURBAN 1/2 TON, C15 / C1500 Todos Resortes Helicoidales Delanteros	
F 87-91		SUBURBAN 1/2 TON, R1500 Todos	
F 68-86		SUBURBAN 3/4 TON, C25 / C2500 Todos	
F 87-91		SUBURBAN 3/4 TON, R2500 Todos	
F 67-80		VAN 1/2 TON, P SERIES Todos	
F 91		VAN 1 TON, P SERIES Todos	
F 75-90		VAN 1 TON, P SERIES Todos Exc. Chasis Motorhome	
F 73-74		VAN 1 TON, P SERIES Base Exc. Chasis Motorhome	
F 68-72		VAN 1 TON, P SERIES Todos	
F 68-89		VAN 3/4 TON, P SERIES Todos	
F 63-65		VAN, PB 1000 SERIES Todos	
61526	D		
R 88-93		DODGE MICROBUS	
R 72-93		PICKUP 1/2 TON, D100 SERIES Todos	
R 72-93		PICKUP 1 TON, D300 SERIES Todos	
R 72-93		PICKUP 3/4 TON, D200 SERIES Todos	
R 95-96		RAMCHARGER 4x2 Tracción trasera	
R 74-93		RAMCHARGER 4x2 Tracción trasera	
R 74-81		PLYMOUTH TRAILDUSTER 4x2 Tracción trasera	
61528	B		
R 05		CHEVROLET BLAZER Base, 4x4	
R 05		BLAZER Base, 4x2 Tracción trasera	
R 96-04		BLAZER LS, 4x4	
R 96-04		BLAZER LS, 4x2 Tracción trasera	
R 95-02		BLAZER LT, 4x2 Tracción trasera	
R 95-01		BLAZER LT, 4x4	
R 95-99		BLAZER Base, 4x4	
R 95-99		BLAZER Base, 4x2 Tracción trasera	
R 95-97		BLAZER Deluxe, 4x2 Tracción trasera	
R 83-94		BLAZER, S MODELS Todos	
R 99-04		S10 LS, 4x4	
R 99-03		S10 Base, 4x4	
R 99-03		S10 Base, 4x2 Tracción trasera	
R 99-03		S10 LS, 4x2 Tracción trasera	
R 94-98		S10 LS	
R 82-98		S10 Base	
R 92-93		S10 EL	
R 83-92		S10 Tahoe	
R 88-90		S10 Durango	
R 82-86		S10 Durango	
R 05		GMC JIMMY 4x4	
R 92-04		JIMMY Todos	
R 83-91		S15 JIMMY Todos	
R 82-04		SONOMA / S15 Todos	
R 91		SYCLONE Todos	
R 92-93		TYPHOON Todos	
R 98-00		ISUZU HOMBRE Todos	
R 96-97		HOMBRE 4x2 Tracción trasera	
R 96-01		OLDSMOBILE BRAVADA Todos	
R 91-94		BRAVADA Todos	
61529	D		140673
F 82		DODGE D50 4x4	
F 87-93		PICKUP, RAM 50 4x4	
F 87-89		RAIDER Todos	
F 83-94		MITSUBISHI MIGHTY MAX 4x4	
F 83-91		MONTERO Todos	
F 87-89		TOYOTA VAN 4x2 Tracción trasera	
F 84-86		VAN Todos	
F 88		VAN WAGON 4x2 Tracción trasera	
61530	C		
R 86-90		FORD F-200	

Lista numérica

Amort.	POP	No. Alternativo	Montaje Accesorio
Pos.	Año	Aplicación	
61530	C	-continued	
R 80-96		PICKUP 1/2 TON, F-150 4x4 Exc. Kit de Levantamiento	
R 86-97		PICKUP 1 TON, F-350 / SUPERDUTY 4x4 Doble Rodada Trasera	
R 82-85		PICKUP 1 TON, F-350 / SUPERDUTY 4x4 Montaje Inferior Delantero Tipo Abrazadera Exc. Doble Rodado o Kit de Levantamiento	
R 80-81		PICKUP 1 TON, F-350 / SUPERDUTY 4x4 Doble Rodada Trasera	
R 97		PICKUP 3/4 TON, F-250 / SUPERDUTY 4x4 PBV arriba de 8500#	
R 86-96		PICKUP 3/4 TON, F-250 / SUPERDUTY 4x4	
R 82-85		PICKUP 3/4 TON, F-250 / SUPERDUTY 4x4 Montaje Inferior Delantero Tipo Abrazadera Exc. Doble Rodado o Kit de Levantamiento	
R 80-81		PICKUP 3/4 TON, F-250 / SUPERDUTY 4x4	
61531	B		
F 05		CHEVROLET BLAZER Base, 4x4	
F 96-04		BLAZER LS, 4x4	
F 95-01		BLAZER LT, 4x4	
F 95-99		BLAZER Base, 4x4	
F 83-94		BLAZER, S MODELS 4x4	
F 94-04		S10 LS, 4x4	
F 83-03		S10 Base, 4x4	
F 92-93		S10 EL, 4x4	
F 83-92		S10 Tahoe, 4x4	
F 88-90		S10 Durango, 4x4	
F 83-86		S10 Durango, 4x4	
F 92-05		GMC JIMMY 4x4	
F 83-91		S15 JIMMY 4x4	
F 83-04		SONOMA / S15 4x4	
F 91		SYCLONE Todos	
F 92-93		TYPHOON Todos	
F 99-00		ISUZU HOMBRE 4x4	
F 96-98		HOMBRE 4x2 Tracción trasera Chasis Deportivo	
F 98		HOMBRE 4x4 Chasis Deportivo	
F 96-01		OLDSMOBILE BRAVADA Todos	
F 91-94		BRAVADA Todos	
61532	W		
R 82		DODGE D50 4x4	
R 87-93		PICKUP, RAM 50 4x4	
R 83-94		MITSUBISHI MIGHTY MAX 4x4	
61533	C		
R 89		FORD BRONCO II Todos Fab. hasta 2/89; Vehículos con perno 10mm y 12mm en montaje inferior trasero	
R 84-88		BRONCO II Todos Con Perno de 10mm en Montaje Inferior Trasero	
R 89		RANGER 4x2 Tracción trasera Fab. hasta 2/89; Vehículos con perno 10mm y 12mm en montaje inferior trasero	
R 83-88		RANGER 4x2 Tracción trasera	
61534	X		
R 83-89		FORD RANGER 4x4	
61535	B		141353
F 84-01		JEEP CHEROKEE Todos	
F 86-92		COMANCHE Todos	
F 93-98		GRAND CHEROKEE Todos	
F 93		GRAND WAGONEER 4x4 Exc. Suspensión Up Country	
F 84-90		WAGONEER Todos	
61536	C		
R 84-01		JEEP CHEROKEE Todos	
R 84-90		WAGONEER Todos	
61538	B		
R 01		CHRYSLER GRAND VOYAGER	
R 91-95		GRAND VOYAGER	
R 90-95		TOWN & COUNTRY Todos	
R 90-94		VOYAGER	
R 84-95		DODGE CARAVAN / GRAND CARAVAN Todos	
R 87-88		MINI RAM Todos	
R 84-95		PLYMOUTH VOYAGER / GRAND VOYAGER Todos	
61539	C		
R 90-05		CHEVROLET ASTRO Todos	

Lista numérica

Amort.	POP	No. Alternativo	Montaje Accesorio
Pos.	Año	Aplicación	
61539	C	-continued	
R	85-89	ASTRO 4x2 Tracción trasera	
R	90-05	GMC SAFARI Todos	
R	85-89	SAFARI 4x2 Tracción trasera	
R	86-89	VOLKSWAGEN VANAGON 4x4	
61540	C	140126	
F	86-97	FORD AEROSTAR 4x2 Tracción trasera	
61541	D		
R	86-88	FORD AEROSTAR 4x2 Tracción trasera	
R	87-95	JEEP WRANGLER YJ (Código plataforma del fabricante)	
61542	B		
F	99-00	CADILLAC ESCALADE Todos	
F	90-05	CHEVROLET ASTRO AWD	
F	92-94	BLAZER 4x4 Automóvil Grande	
F	88-00	PICKUP 1 TON, K35 / K3500 Todos	
F	88-00	PICKUP 3/4 TON, K25 / K2500 Todos	
F	92-99	SUBURBAN 1/2 TON, K15 / K1500 Todos	
F	92-99	SUBURBAN 3/4 TON, K25 / K2500 Todos	
F	95-00	TAHOE 4x4 Old Body Style	
F	88-00	GMC PICKUP 1 TON, K35 / K3500 Todos	
F	88-00	PICKUP 3/4 TON, K25 / K2500 Todos	
F	90-05	SAFARI AWD	
F	92-99	SUBURBAN 1/2 TON, K15 / K1500 Todos	
F	92-99	SUBURBAN 3/4 TON, K25 / K2500 Todos	
F	92-99	YUKON 4x4	
F	99	YUKON Denali	
61543	B		
R	98	CHEVROLET 400SS PICKUP	
R	92-96	400SS PICKUP	
R	96-97	BOSS TRUCK	
R	90-96	MICROBUS	
R	88-99	PICKUP 1/2 TON, C15 / C1500 Todos	
R	88-99	PICKUP 1/2 TON, K15 / K1500 Todos	
R	01-03	PICKUP 1 TON, C35/3500 HD Eje Delantero Rígido	
R	91-00	PICKUP 1 TON, C35/3500 Todos Eje Delantero Rígido HD	
R	88-90	PICKUP 1 TON, C35/3500 Extended Cab Pickup Eje Delantero Rígido HD	
R	88-90	PICKUP 1 TON, C35/3500 Standard Cab Pickup Eje Delantero Rígido HD	
R	88-00	PICKUP 1 TON, K35 / K3500 Todos	
R	88-00	PICKUP 3/4 TON, C25 / C2500 Todos	
R	88-00	PICKUP 3/4 TON, K25 / K2500 Todos	
R	88-99	GMC PICKUP 1/2 TON, C15 / C1500 Todos	
R	88-99	PICKUP 1/2 TON, K15 / K1500 Todos	
R	91-00	PICKUP 1 TON, C35/3500 Todos Eje Delantero Rígido HD	
R	88-90	PICKUP 1 TON, C35/3500 Extended Cab Pickup Eje Delantero Rígido HD	
R	88-90	PICKUP 1 TON, C35/3500 Standard Cab Pickup Eje Delantero Rígido HD	
R	88-00	PICKUP 1 TON, K35 / K3500 Todos	
R	88-00	PICKUP 3/4 TON, C25 / C2500 Todos	
R	88-00	PICKUP 3/4 TON, K25 / K2500 Todos	
61544	A	141277	
F	92-96	CHEVROLET 400SS PICKUP	
F	96-97	BOSS TRUCK	
F	90-96	MICROBUS	
F	88-99	PICKUP 1/2 TON, C15 / C1500 Todos	
F	92-00	PICKUP 1 TON, C35/3500 Crew Cab Pickup Eje Delantero Rígido HD	
F	88-00	PICKUP 1 TON, C35/3500 Extended Cab Pickup Eje Delantero Rígido HD	
F	88-00	PICKUP 1 TON, C35/3500 Standard Cab Pickup Eje Delantero Rígido HD	
F	88-00	PICKUP 3/4 TON, C25 / C2500 Todos	
F	92-99	SUBURBAN 1/2 TON, C15 / C1500 Todos	
F	92-99	SUBURBAN 3/4 TON, C25 / C2500 Todos	

Amortiguadores ProGuard

Amort.	POP	No. Alternativo	Montaje Accesorio
Pos.	Año	Aplicación	
61544	A	-continued 141277	
F	95-00	TAHOE 4x2 Tracción trasera Old Body Style	
F	88-99	GMC PICKUP 1/2 TON, C15 / C1500 Todos	
F	92-00	PICKUP 1 TON, C35/3500 Crew Cab Pickup Eje Delantero Rígido HD	
F	88-00	PICKUP 1 TON, C35/3500 Extended Cab Pickup Eje Delantero Rígido HD	
F	88-00	PICKUP 1 TON, C35/3500 Standard Cab Pickup Eje Delantero Rígido HD	
F	88-00	PICKUP 3/4 TON, C25 / C2500 Todos	
F	92-99	SUBURBAN 1/2 TON, C15 / C1500 Todos	
F	92-99	SUBURBAN 3/4 TON, C25 / C2500 Todos	
F	92-99	YUKON 4x2 Tracción trasera	
61546	C	141047	
F	80-96	FORD BRONCO Todos Suspensión Quad adelante del Eje Delantero; Exc. Kit de Levantamiento	
F	83-85	F-350 PICKUP	
F	80	F-350 PICKUP	
F	80-96	PICKUP 1/2 TON, F-150 4x4 Suspensión Quad adelante del Eje Delantero; Exc. Kit de Levantamiento	
F	80-81	PICKUP 1 TON, F-350 / SUPERDUTY 4x4	
F	80-82	PICKUP 3/4 TON, F-250 / SUPERDUTY 4x4	
61547	C		
R	92	FORD B200	
R	85-96	PICKUP 1/2 TON, F-150 4x2 Tracción trasera	
R	80-97	PICKUP 1 TON, F-350 / SUPERDUTY 4x2 Tracción trasera Exc. Doble Rodada Trasera	
R	97	PICKUP 3/4 TON, F-250 / SUPERDUTY 4x2 Tracción trasera PBV arriba de 8500#	
R	80-96	PICKUP 3/4 TON, F-250 / SUPERDUTY 4x2 Tracción trasera	
61549	W	140455	
F	86-95	SUZUKI SAMURAI Todos	
61550	W		
R	86-95	SUZUKI SAMURAI Todos	
61551	D	141353	
F	78-79	FORD BRONCO Todos Suspensión Quad adelante del Eje Delantero; Exc. Kit de Levantamiento	
F	78-79	PICKUP 1/2 TON, F-150 Ranger Lariat, 4x4 Suspensión Quad Amortiguador Largo; Exc. Kit de Levantamiento	
F	78-79	PICKUP 1/2 TON, F-150 Ranger, 4x4 Suspensión Quad Amortiguador Largo; Exc. Kit de Levantamiento	
F	79	PICKUP 1/2 TON, F-150 Custom, 4x4 Suspensión Quad adelante del Eje Delantero; Exc. Kit de Levantamiento	
F	78	PICKUP 1/2 TON, F-150 Base, 4x4 Suspensión Quad Amortiguador Largo; Exc. Kit de Levantamiento	
F	78	PICKUP 1/2 TON, F-150 Custom, 4x4 Suspensión Quad Amortiguador Largo; Exc. Kit de Levantamiento	
F	78	PICKUP 1/2 TON, F-150 Northland, 4x4 Suspensión Quad Amortiguador Largo; Exc. Kit de Levantamiento	
F	87-95	JEEP WRANGLER YJ (Código plataforma del fabricante)	
61552	B	140524	
F	86-95	TOYOTA 4RUNNER Todos	
F	86-95	PICKUP 4x4 Exc. Kit de Levantamiento	
F	93-98	T100 4x4	
61553	D	140780	
F	79-81	FORD B100	
F	73-74	B100	
F	82	B150	
F	75-78	B150	
F	75-91	VAN 1/2 TON, ECONOLINE / CLUB WAGON Todos	
61554	C		
R	97	FORD BRONCO	

Lista numérica

Amort.	POP	No. Alternativo	Montaje Accesorio
Pos.	Año	Aplicación	
61554	C	-continued	
R	80-96	BRONCO Todos Exc. Kit de Levantamiento	
R	80-83	PICKUP 1/2 TON, F-100 4x2 Tracción trasera	
R	80-84	PICKUP 1/2 TON, F-150 4x2 Tracción trasera	
R	90-97	PICKUP 1/2 TON, F SUPERDUTY Todos	
R	80-97	PICKUP 1 TON, F-350 / SUPERDUTY 4x2 Tracción trasera Doble Rodada Trasera	
R	97	PICKUP, F-450 SUPERDUTY Todos	
R	10	NISSAN URVAN Todos amortiguador trasero sin buje metálico	
R	02-08	URVAN Todos amortiguador trasero sin buje metálico	
61555	B	142615	
F	85-05	CHEVROLET ASTRO 4x2 Tracción trasera	
F	81	BEL AIR Sedan Modelos Policía y Taxi	
F	71-75	BEL AIR Sedan Modelos Policía y Taxi	
F	71-72	BISCAYNE Todos Modelos Policía y Taxi	
F	73-96	CAPRICE Sedan Modelos Policía y Taxi	
F	71-72	CAPRICE Todos Modelos Policía y Taxi	
F	83-85	IMPALA Todos Modelos Policía y Taxi	
F	71-82	IMPALA Sedan Modelos Policía y Taxi	
F	96-02	VAN 1/2 TON, G / EXPRESS Todos	
F	97-02	VAN 1 TON, G / EXPRESS Todos	
F	96-02	VAN 3/4 TON, G / EXPRESS Todos Exc. PBV 8600 #	
F	93-02	FORD CROWN VICTORIA Police Interceptor Modelos Policía y Taxi	
F	85-05	GMC SAFARI 4x2 Tracción trasera	
F	96-02	VAN 1/2 TON, G / SAVANNA Todos	
F	96-02	VAN 1 TON, G / SAVANNA Todos	
F	96-02	VAN 3/4 TON, G / SAVANNA Todos Exc. PBV 8600 #	
61556	D	140455	
F	79-82	DODGE D50 4x2 Tracción trasera	
F	87-93	PICKUP, RAM 50 4x2 Tracción trasera	
F	83-86	PICKUP, RAM 50 Todos	
F	83-96	MITSUBISHI MIGHTY MAX 4x2 Tracción trasera	
F	79-82	PLYMOUTH ARROW PICKUP Todos	
61557	C		
R	90-97	FORD AEROSTAR Todos	
R	89	AEROSTAR 4x2 Tracción trasera	
61558	D	140524	
R	87-88	ISUZU TROOPER Todos	
61559	A		
R	90	FORD BRONCO II Todos	
R	89	BRONCO II Todos Fab. desde 2/89; Vehículos con perno de 12mm en montaje inferior trasero	
R	90-97	RANGER 4x2 Tracción trasera	
R	89	RANGER 4x2 Tracción trasera Fab. desde 2/89; Vehículos con perno de 12mm en montaje inferior trasero	
R	94-97	MAZDA B2300 4x2 Tracción trasera	
R	94-97	B3000 4x2 Tracción trasera	
R	94	B4000 4x2 Tracción trasera	
61560	D	141514	
R	92-93	ASUNA SUNRUNNER Todos	
R	98-04	CHEVROLET TRACKER Non-ABS	
R	89-97	GEO TRACKER Todos	
R	94-97	PONTIAC SUNRUNNER Todos	
R	99-05	SUZUKI GRAND VITARA Todos	
R	89-98	SIDEKICK Todos	
R	99-04	VITARA Todos	
R	96-98	X-90 Todos	
61561	A	140780	
F	90	FORD BRONCO II Todos	
F	90-97	RANGER Todos	
F	94-97	MAZDA B2300 Todos	
F	94-97	B3000 Todos	
F	94-97	B4000 4x2 Tracción trasera	

Lista numérica

Amort.	POP	No. Alternativo	Montaje Accesorio
Pos.	Año	Aplicación	
61565	B		
R	99-00	CADILLAC	ESCALADE Todos
R	92-94	CHEVROLET	BLAZER 4x4 Automóvil Grande
R	92-99		SUBURBAN 1/2 TON, C15 / C1500 Todos
R	92-99		SUBURBAN 1/2 TON, K15 / K1500 Todos
R	92-99		SUBURBAN 3/4 TON, C25 / C2500 Todos
R	92-99		SUBURBAN 3/4 TON, K25 / K2500 Todos
R	95-00		TAHOE Todos Old Body Style
R	03-11		VAN 1/2 TON, G / EXPRESS Todos Exc. Upfitter Package y Cutaway Chassis
R	96-02		VAN 1/2 TON, G / EXPRESS Todos
R	97-02		VAN 1 TON, G / EXPRESS Todos
R	96		VAN 1 TON, G / EXPRESS Todos Exc. PBV 8600 #
R	96-02		VAN 3/4 TON, G / EXPRESS Todos Exc. PBV 8600 #
R	92-99		GMC SUBURBAN 1/2 TON, C15 / C1500 Todos
R	92-99		SUBURBAN 1/2 TON, K15 / K1500 Todos
R	92-99		SUBURBAN 3/4 TON, C25 / C2500 Todos
R	92-99		SUBURBAN 3/4 TON, K25 / K2500 Todos
R	03-11		VAN 1/2 TON, G / SAVANNA Todos Exc. Upfitter Package y Cutaway Chassis
R	96-02		VAN 1/2 TON, G / SAVANNA Todos
R	96-02		VAN 1 TON, G / SAVANNA Todos Exc. PBV 8600 #
R	96-02		VAN 3/4 TON, G / SAVANNA Todos Exc. PBV 8600 #
R	92-99		YUKON Todos
R	99		YUKON Denali
61568	X		
R	89		DODGE RAIDER 3.0L 6Cyl V (181) 3.0L 6 Cyl
R	89-91		MITSUBISHI MONTERO 3.0L 6Cyl V (181)
R	89		MONTERO 2.6L 4Cyl L (156)
61569	W		140780
F	90-97		FORD AEROSTAR AWD
61573	C		
R	90-97		FORD RANGER 4x4
R	89		RANGER 4x4 Opción High Ryder
R	95-96		MAZDA B2300 4x4
61575	C		
R	93-98		JEEP GRAND CHEROKEE Todos
61582	D		
R	93-98		TOYOTA T100 4x4
61584	D		
R	87-96		DODGE DAKOTA 4x4
61586	D		141350
R	89-91		ISUZU TROOPER Todos
61588	D		140921
R	90-95		TOYOTA 4RUNNER Todos
61589	W		
R	89-98		MAZDA MPV 4x2 Tracción trasera
61590	C		140719
R	91-94		FORD EXPLORER Todos
R	91-94		MAZDA NAVAJO Todos
61591	B		140780
F	91-94		FORD EXPLORER Todos
F	92-11		VAN 1/2 TON, ECONOLINE / CLUB WAGON Todos
F	92-11		VAN 1 TON, ECONOLINE / CLUB WAGON / SUPERDUTY Todos
F	92-02		VAN 3/4 TON, ECONOLINE / CLUB WAGON / SUPERDUTY Todos
F	91-94		MAZDA NAVAJO Todos
61592	D		142389
R	94-97		HONDA PASSPORT Todos
R	91-97		ISUZU RODEO Todos
R	98-03		TOYOTA SIENNA Todos
61593	B		140524
F	94-02		HONDA PASSPORT Todos
F	98-00		ISUZU AMIGO Todos
F	02-04		AXIOM Todos

Amortiguadores ProGuard

Amort.	POP	No. Alternativo	Montaje Accesorio
Pos.	Año	Aplicación	
61593	B	-continued	140524
F	91-04		RODEO Todos
F	87-91		TROOPER Todos
F	86-87		MAZDA B2000 4x2 Tracción trasera
F	87-93		B2200 4x2 Tracción trasera
F	87-93		B2600 4x2 Tracción trasera
F	87-90		MITSUBISHI VAN Todos
F	87-95		NISSAN PATHFINDER Todos Exc. Suspensión Electrónica Ajustable
61594	D		141405
R	91-97		TOYOTA PREVIA Todos
61595	C		140780
R	92-11		FORD VAN 1/2 TON, ECONOLINE / CLUB WAGON Todos
61596	W		140524
F	87-93		MAZDA B2600 4x4
61597	W		140169
R	87-93		MAZDA B2600 4x4
61598	X		
R	89-98		MAZDA MPV 4x4
61599	B		143000
F	94-97		DODGE MICROBUS
F	94-01		PICKUP 1/2 TON, RAM 1500 4x2 Tracción trasera
F	94-02		PICKUP 1 TON, RAM 3500 4x2 Tracción trasera Exc. Eje Delantero Rígido
F	94-02		PICKUP 3/4 TON, RAM 2500 4x2 Tracción trasera
F	99-01		RAMCHARGER Todos
61600	A		
R	99-07		CHEVROLET PICKUP 1/2 TON, SILVERADO 1500 4x2 Tracción trasera Exc. Suspensión Electrónica Ajustable
R	07		SILVERADO 1500 CLASSIC 4x2 Tracción trasera
R	07		SILVERADO 1500 CLASSIC 4x2 Tracción trasera Exc. Suspensión Electrónica Ajustable
R	94-97		DODGE MICROBUS
R	94-01		PICKUP 1/2 TON, RAM 1500 Todos
R	94-02		PICKUP 1 TON, RAM 3500 4x2 Tracción trasera Exc. Eje Delantero Rígido
R	94-03		PICKUP 3/4 TON, RAM 2500 4x4, GAS Exc. PBV 8600 #
R	94-03		PICKUP 3/4 TON, RAM 2500 4x4, GAS Exc. PBV 8800#
R	94-02		PICKUP 3/4 TON, RAM 2500 4x2 Tracción trasera
R	95-96		PICKUP 3/4 TON, RAM 2500 4x4, CNG Exc. PBV 8600 #
R	95-96		PICKUP 3/4 TON, RAM 2500 4x4, CNG Exc. PBV 8800#
R	99-01		RAMCHARGER Todos
R	99-06		GMC SIERRA 1500 4x2 Tracción trasera Exc. Suspensión Electrónica Ajustable
R	07		SIERRA 1500 CLASSIC 4x2 Tracción trasera Exc. Suspensión Electrónica Ajustable
61601	C		140126
F	97-04		DODGE DAKOTA 4x4
F	98-03		DURANGO 4x4
61605	B		
R	96-07		CHRYSLER TOWN & COUNTRY Todos
R	01-03		VOYAGER / GRAND VOYAGER Todos Exc. Sistema de Autonivelación NIVOMAT
R	96-00		VOYAGER / GRAND VOYAGER Todos
R	00		VOYAGER / GRAND VOYAGER Non-ABS Exc. Sistema de Autonivelación NIVOMAT
R	96-07		DODGE CARAVAN / GRAND CARAVAN Todos Exc. Sistema de Autonivelación NIVOMAT
R	96-00		PLYMOUTH VOYAGER / GRAND VOYAGER Todos
61606	D		140673
F	01-04		TOYOTA TACOMA S-Runner Exc. Offroad Package
F	04		TACOMA Base, 4x2 Tracción trasera Exc. Offroad Package

Lista numérica

Amort.	POP	No. Alternativo	Montaje Accesorio
Pos.	Año	Aplicación	
61606	D	-continued	140673
F	95-03		TACOMA DLX, 4x2 Tracción trasera Exc. Offroad Package
61607	D		141354
F	96-99		ACURA SLX Todos
F	92-02		ISUZU TROOPER Todos
F	99-01		VEHICROSS Todos
61608	D		140169
R	96-99		ACURA SLX Todos
R	92-02		ISUZU TROOPER Todos
R	99-01		VEHICROSS Todos
61609	D		141137
R	97-99		INFINITI QX4 Todos Fab. hasta 12/98
R	96-99		NISSAN PATHFINDER Todos Fab. hasta 12/98
61610	D		140524
R	98-02		HONDA PASSPORT Todos
R	98-00		ISUZU AMIGO Todos
R	02-04		AXIOM Todos
R	98-04		RODEO Todos
61611	A		142731
F	97-02		FORD EXPEDITION 4x2 Tracción trasera Exc. Nivelación Nuemática Delantera
F	97-04		LOBO PICK UP
F	97-04		PICKUP 1/2 TON, F-150 4x2 Tracción trasera
F	96-99		PICKUP 3/4 TON, F-250 / SUPERDUTY 4x2 Tracción trasera Hasta PBV 8500#
F	98-02		LINCOLN NAVIGATOR Coil (FrontSpringType)
61612	C		142700
R	97-04		FORD LOBO PICK UP
R	97-04		PICKUP 1/2 TON, F-150 4x4 Exc. PBV 7700#
R	97-99		PICKUP 3/4 TON, F-250 / SUPERDUTY 4x4 Hasta PBV 8500#, Exc. Superduty
61613	B		142731
F	97-02		FORD EXPEDITION 4x4 Exc. Nivelación Nuemática Delantera
F	97-03		LOBO PICK UP
F	04		PICKUP 1/2 TON, F-150 4x4 Exc. PBV 7700#
F	97-03		PICKUP 1/2 TON, F-150 4x4
F	97-99		PICKUP 3/4 TON, F-250 / SUPERDUTY 4x4 Hasta PBV 8500#, Exc. Superduty
61614	C		
R	97-02		FORD EXPEDITION Todos
R	86-90		F-200
F	65-78		F-350 PICKUP
R	97-03		LOBO PICK UP
F	86-97		PICKUP 1 TON, F-350 / SUPERDUTY 4x4
F	97		PICKUP 3/4 TON, F-250 / SUPERDUTY 4x4 PBV arriba de 8500#
F	87-96		PICKUP 3/4 TON, F-250 / SUPERDUTY 4x4
R	98-02		LINCOLN NAVIGATOR 4x2 Tracción trasera
R	72-01		VOLKSWAGEN COMBI
R	95-01		COMBI Todos
R	52-77		COMBI CARAVEL
R	72-01		COMBI PANEL
61615	D		141665
F	97-06		JEEP WRANGLER TJ (Código plataforma del fabricante)
61616	D		
R	97-06		JEEP WRANGLER TJ (Código plataforma del fabricante)
61623	A		142277
F	95-01		FORD EXPLORER Todos Exc. Suspensión Electrónica Ajustable
F	01-05		EXPLORER SPORT TRAC Todos
F	12		RANGER Todos 4x4
F	12		RANGER 4x2 Tracción trasera, Torsion (FrontSpringType)
F	06-11		RANGER 4x2 Tracción trasera, Barra de Torsion (FrontSpringType)
F	98-11		RANGER 4x4
F	01-05		RANGER Edge, 4x2 Tracción trasera

Lista numérica

Amort.	POP	No. Alternativo	Montaje Accesorio
Pos.	Año	Aplicación	
61623	A	-continued	142277
F	03-06	MAZDA B3000 Todos 4x4	
F	98-02	B3000 4x4	
F	98-06	B4000 4x4	
F	97-01	MERCURY MOUNTAINEER Todos Exc. Suspensión Electrónica Ajustable	
61624	B		140719
R	95-01	FORD EXPLORER Todos Exc. Suspensión de Aire	
R	98	EXPLORER Todos	
R	01-05	EXPLORER SPORT TRAC Todos	
R	97-01	MERCURY MOUNTAINEER Todos Exc. Suspensión Electrónica Ajustable	
61625	C		
R	94-03	FORD WINDSTAR	
R	95-03	WINDSTAR Todos	
R	95-03	WINDSTAR Coil (RearSpringType)	
61626	B		141665
F	12	FORD RANGER 4x2 Tracción trasera Coil (FrontSpringType)	
F	06-11	RANGER 4x2 Tracción trasera, Coil (FrontSpringType)	
F	01-05	RANGER XL, 4x2 Tracción trasera, Coil (FrontSpringType)	
F	01-05	RANGER XLT, 4x2 Tracción trasera, Coil (FrontSpringType)	
F	98-00	RANGER XL, 4x2 Tracción trasera	
F	98-00	RANGER XLT, 4x2 Tracción trasera	
F	01-06	MAZDA B2300 4x2 Tracción trasera	
F	98-01	B2500 4x2 Tracción trasera	
F	98-06	B3000 4x2 Tracción trasera	
F	98-06	B4000 4x2 Tracción trasera	
61627	B		
R	12	FORD RANGER 4x2 Tracción trasera Coil (FrontSpringType)	
R	06-11	RANGER 4x2 Tracción trasera, Coil (FrontSpringType)	
R	98-05	RANGER XL, 4x2 Tracción trasera	
R	98-05	RANGER XLT, 4x2 Tracción trasera	
R	05	RANGER STX, 4x2 Tracción trasera	
R	04	RANGER Tremor, 4x2 Tracción trasera	
R	01-06	MAZDA B2300 4x2 Tracción trasera	
R	98-01	B2500 4x2 Tracción trasera	
R	98-06	B3000 4x2 Tracción trasera	
R	98-06	B4000 4x2 Tracción trasera	
61629	B		
R	12	FORD RANGER Todos 4x4	
R	12	RANGER 4x2 Tracción trasera, Torsion (FrontSpringType)	
R	06-11	RANGER 4x2 Tracción trasera, Barra de Torsion (FrontSpringType)	
R	98-11	RANGER 4x4	
R	01-05	RANGER Edge, 4x2 Tracción trasera	
R	03-06	MAZDA B3000 Todos 4x4	
R	98-02	B3000 4x4	
R	98-06	B4000 4x4	
61632	W		
F	81-93	DODGE PICKUP 1/2 TON, W100 SERIES Todos Exc. Kit de Levantamiento	
F	61-80	PICKUP 1/2 TON, W100 SERIES Todos	
F	81-93	PICKUP 1 TON, W300 SERIES Todos Exc. Suspensión Quad y Kit de Levantamiento	
F	61-80	PICKUP 1 TON, W300 SERIES Todos	
R	61-71	PICKUP 1 TON, W300 SERIES Todos	
F	90-93	PICKUP 3/4 TON, W200 SERIES Extended Cab Pickup Exc. Kit de Levantamiento	
F	88-93	PICKUP 3/4 TON, W200 SERIES Cab & Chassis Exc. Kit de Levantamiento	
F	81-93	PICKUP 3/4 TON, W200 SERIES Standard Cab Pickup Exc. Kit de Levantamiento	
F	86	PICKUP 3/4 TON, W200 SERIES Cab & Chassis Exc. Kit de Levantamiento	
F	81-83	PICKUP 3/4 TON, W200 SERIES Cab & Chassis Exc. Kit de Levantamiento	

Amortiguadores ProGuard

Amort.	POP	No. Alternativo	Montaje Accesorio
Pos.	Año	Aplicación	
61632	W	-continued	
F	81-82	PICKUP 3/4 TON, W200 SERIES Extended Cab Pickup Exc. Kit de Levantamiento	
F	69-80	PICKUP 3/4 TON, W200 SERIES Todos	
F	61-67	PICKUP 3/4 TON, W200 SERIES Todos	
F	75-93	RAMCHARGER 4x4	
F	74	RAMCHARGER 4x4 4x4	
F	74-81	PLYMOUTH TRAILDUSTER 4x4	
61633	W		
R	81-93	DODGE PICKUP 1/2 TON, W100 SERIES Todos Exc. Kit de Levantamiento	
R	72-80	PICKUP 1/2 TON, W100 SERIES Todos	
R	81-93	PICKUP 1 TON, W300 SERIES Todos Exc. Suspensión Quad y Kit de Levantamiento	
R	72-80	PICKUP 1 TON, W300 SERIES Todos	
R	90-93	PICKUP 3/4 TON, W200 SERIES Extended Cab Pickup Exc. Kit de Levantamiento	
R	88-93	PICKUP 3/4 TON, W200 SERIES Cab & Chassis Exc. Kit de Levantamiento	
R	81-93	PICKUP 3/4 TON, W200 SERIES Standard Cab Pickup Exc. Kit de Levantamiento	
R	86	PICKUP 3/4 TON, W200 SERIES Cab & Chassis Exc. Kit de Levantamiento	
R	81-83	PICKUP 3/4 TON, W200 SERIES Cab & Chassis Exc. Kit de Levantamiento	
R	81-82	PICKUP 3/4 TON, W200 SERIES Extended Cab Pickup Exc. Kit de Levantamiento	
R	72-80	PICKUP 3/4 TON, W200 SERIES Todos	
R	76-93	RAMCHARGER 4x4	
R	76-81	PLYMOUTH TRAILDUSTER 4x4	
61634	C		142731
F	94-01	DODGE PICKUP 1/2 TON, RAM 1500 4x4	
F	94-02	PICKUP 3/4 TON, RAM 2500 4x4, GAS Exc. PBV 8600 #	
F	95-96	PICKUP 3/4 TON, RAM 2500 4x4, CNG Exc. PBV 8600 #	
61635	C		142731
F	94-02	DODGE PICKUP 1 TON, RAM 3500 4x4	
F	94-02	PICKUP 1 TON, RAM 3500 4x2 Tracción trasera Eje Delantero Rígido	
F	94-02	PICKUP 3/4 TON, RAM 2500 4x4, DIESEL PBV 8800	
61637	D		140885
R	97-02	MERCURY VILLAGER Non-ABS	
R	93-96	VILLAGER 4-Wheel ABS	
R	93-02	NISSAN QUEST Todos	
61638	B		142700
R	97-04	FORD LOBO PICK UP	
R	04	PICKUP 1/2 TON, F-150 4x2 Tracción trasera	
R	00-03	PICKUP 1/2 TON, F-150 Harley-Davidson Edition, 4x2 Tracción trasera	
R	99-03	PICKUP 1/2 TON, F-150 Lariat, 4x2 Tracción trasera	
R	99-03	PICKUP 1/2 TON, F-150 XL, 4x2 Tracción trasera	
R	99-03	PICKUP 1/2 TON, F-150 XLT, 4x2 Tracción trasera	
R	00	PICKUP 1/2 TON, F-150 Base, 4x2 Tracción trasera	
R	97-98	PICKUP 1/2 TON, F-150 4x2 Tracción trasera	
R	97-99	PICKUP 3/4 TON, F-250 / SUPERDUTY 4x2 Tracción trasera Hasta PBV 8500#	
61641	B		141665
F	99-06	CHEVROLET PICKUP 1/2 TON, SILVERADO 1500 4x2 Tracción trasera Exc. Suspensión Electrónica Ajustable	

Lista numérica

Amort.	POP	No. Alternativo	Montaje Accesorio
Pos.	Año	Aplicación	
61641	B	-continued	141665
F	99-04	PICKUP 3/4 TON, SILVERADO 2500 4x2 Tracción trasera PBV 8600 Lb.; Exc. Suspensión Quadrasteer	
F	07	SILVERADO 1500 CLASSIC 4x2 Tracción trasera Exc. Suspensión Electrónica Ajustable	
F	99-06	GMC SIERRA 1500 4x2 Tracción trasera Exc. Suspensión Electrónica Ajustable	
F	07	SIERRA 1500 CLASSIC 4x2 Tracción trasera Exc. Suspensión Electrónica Ajustable	
61642	A		
R	00	CHEVROLET K1500	
R	99-06	PICKUP 1/2 TON, SILVERADO 1500 4x4 Estilo Carrocería Clasica y Antigua, Exc. Suspensión Electrónica Ajustable	
R	05-06	PICKUP 1/2 TON, SILVERADO 1500 HD Todos	
R	01-03	PICKUP 1/2 TON, SILVERADO 1500 HD Todos	
R	77-86	PICKUP 1 TON, K30 Todos	
R	90-91	PICKUP 1 TON, R3500 Todos	
R	89	PICKUP 1 TON, R3500 Cab & Chassis, 4x2 Tracción trasera	
R	89	PICKUP 1 TON, R3500 Crew Cab Pickup, 4x2 Tracción trasera	
R	01-09	PICKUP 1 TON, SILVERADO 3500 Todos	
R	07-10	PICKUP 1 TON, SILVERADO 3500 HD Todos	
R	87-88	PICKUP 1 TON, V30 Todos	
R	89-91	PICKUP 1 TON, V3000 / V3500 Todos	
R	99-08	PICKUP 3/4 TON, SILVERADO 2500 Todos	
R	01-10	PICKUP 3/4 TON, SILVERADO 2500 HD Todos	
R	07	SILVERADO 1500 CLASSIC 4x4 Exc. Suspensión Electrónica Ajustable	
R	94-02	DODGE PICKUP 1 TON, RAM 3500 4x4	
R	94-02	PICKUP 1 TON, RAM 3500 4x2 Tracción trasera Eje Delantero Rígido	
R	94-02	PICKUP 3/4 TON, RAM 2500 4x4, DIESEL PBV 8800	
R	77-86	GMC PICKUP 1 TON, K35 / K3500 Todos	
R	87-91	PICKUP 1 TON, V3000 / V3500 Todos	
R	99-06	SIERRA 1500 4x4 Estilo Carrocería Clasica y Antigua, Exc. Suspensión Electrónica Ajustable	
R	07	SIERRA 1500 CLASSIC 4x4 Exc. Suspensión Electrónica Ajustable	
R	05-06	SIERRA 1500 HD Todos	
R	01-03	SIERRA 1500 HD Todos	
R	99-04	SIERRA 2500 Todos	
R	01-10	SIERRA 2500 HD Todos	
R	01-06	SIERRA 3500 Todos	
R	07-10	SIERRA 3500 HD Todos	
61643	A		141665
F	02-06	CHEVROLET AVALANCHE 1500 Todos Exc. Control de Manejo Electrónico	
F	99-06	PICKUP 1/2 TON, SILVERADO 1500 4x4 Estilo Carrocería Clasica y Antigua, Exc. Suspensión Electrónica Ajustable	
F	07	SILVERADO 1500 CLASSIC 4x4 Exc. Suspensión Electrónica Ajustable	
F	00-06	SONORA Todos Exc. Suspensión Z55	
F	00-06	SUBURBAN 1/2 TON, 1500 Todos Exc. Suspensión Z55 Auto Ride	
F	02-06	TAHOE Todos Exc. Suspensión Z55 Auto Ride	
F	00-01	TAHOE Todos Estilo New Body, Exc. Suspensión Z55	
F	99-06	GMC SIERRA 1500 4x4 Estilo Carrocería Clasica y Antigua, Exc. Suspensión Electrónica Ajustable	
F	07	SIERRA 1500 CLASSIC 4x4 Exc. Suspensión Electrónica Ajustable	
F	00-06	YUKON Todos Exc. Suspensión Z55 Auto Ride	
F	00-06	YUKON XL 1/2 TON Todos Exc. Suspensión Z55 Auto Ride	

Lista numérica

Amort.	POP	No. Alternativo	Montaje Accesorio
Pos.	Año	Aplicación	
61646	C		142617
R	99-02	FORD ECONOLINE WAGON	
R	12-14	VAN 1/2 TON, ECONOLINE / CLUB WAGON Todos	
R	10-14	VAN 1 TON, ECONOLINE / CLUB WAGON / SUPERDUTY Todos	
R	04-11	VAN 1 TON, ECONOLINE / CLUB WAGON / SUPERDUTY Todos Exc. Cutaway Chassis	
R	04-11	VAN 1 TON, ECONOLINE / CLUB WAGON / SUPERDUTY Todos Exc. Paquete de Ambulancia y Manejo	
R	92-05	VAN 1 TON, ECONOLINE / CLUB WAGON / SUPERDUTY Todos	
R	92-14	VAN 3/4 TON, ECONOLINE / CLUB WAGON / SUPERDUTY Todos	
61647	W		140126
R	76-79	FORD PICKUP 1/2 TON, F-150 4x4 Exc. Kit de Levantamiento	
R	75	PICKUP 1/2 TON, F-150 Todos 4x4; Exc. Kit de Levantamiento	
R	79	PICKUP 1 TON, F-350 / SUPERDUTY 4x4	
R	75-91	VAN 1 TON, ECONOLINE / CLUB WAGON / SUPERDUTY Todos Exc. Conversión Motorhome	
R	75-91	VAN 3/4 TON, ECONOLINE / CLUB WAGON / SUPERDUTY Todos	
61649	D		
R	73-78	CHEVROLET CS1073	
R	73-78	CS31003	
R	99	P31	
R	73-86	PICKUP 1 TON, C30 Todos	
R	88-91	PICKUP 1 TON, C35/3500 Cab & Chassis Exc. Eje Rígido Delantero HD	
R	87-88	PICKUP 1 TON, R30 Todos	
R	89	PICKUP 1 TON, R3500 Standard Cab Pickup	
R	75-86	PICKUP 3/4 TON, C20 Crew Cab Pickup	
R	73-74	PICKUP 3/4 TON, C20 Todos Crew Cab Pickup	
R	88	PICKUP 3/4 TON, R20 Todos	
R	87	PICKUP 3/4 TON, R20 Crew Cab Pickup	
R	89	PICKUP 3/4 TON, R2500 Todos	
R	74-80	VAN 1/2 TON, P SERIES Todos	
R	73-99	VAN 1 TON, P SERIES Todos	
R	79-89	VAN 3/4 TON, P SERIES Todos	
R	88-91	GMC PICKUP 1 TON, C35/3500 Cab & Chassis Exc. Eje Rígido Delantero HD	
R	73-78	PICKUP 1 TON, C35/3500 Todos	
R	87-91	PICKUP 1 TON, R3500 Todos	
R	85-86	PICKUP 3/4 TON, C25 / C2500 Crew Cab Pickup	
R	75-83	PICKUP 3/4 TON, C25 / C2500 Crew Cab Pickup	
R	73-74	PICKUP 3/4 TON, C25 / C2500 Todos Crew Cab	
R	87-89	PICKUP 3/4 TON, R2500 Crew Cab Pickup	
R	74-80	VAN 1/2 TON, P SERIES Todos	
R	73-99	VAN 1 TON, P SERIES Todos	
R	79-89	VAN 3/4 TON, P SERIES Todos	
61650	C		140126
F	88-93	DODGE MICROBUS	
F	72-93	PICKUP 1 TON, D300 SERIES Todos Paquete HD	
F	82-93	PICKUP 3/4 TON, D200 SERIES Todos Paquete HD	
F	81	PICKUP 3/4 TON, D200 SERIES 165.0 (WheelBase) Paquete HD	
F	77-80	PICKUP 3/4 TON, D200 SERIES Todos Paquete HD	
F	75-76	PICKUP 3/4 TON, D200 SERIES 165.0 (WheelBase) Paquete HD	
F	72-74	PICKUP 3/4 TON, D200 SERIES Todos Paquete HD	
F	71-93	VAN 1 TON, A / B SERIES / RAM Todos Con Eje Delantero 4000#	
F	74-80	VAN, CB300 Todos Con Eje Delantero 4000#	
F	74-83	PLYMOUTH VAN 1 TON, PB SERIES Todos Con Eje Delantero 4000#	
61651	D		142389
R	00	TOYOTA RAV4 Todos Fab. hasta 5/00	
R	96-99	RAV4 Todos	

Amortiguadores ProGuard

Amort.	POP	No. Alternativo	Montaje Accesorio
Pos.	Año	Aplicación	
61654	C		
R	99-04	FORD PICKUP 1 TON, F-350 / SUPERDUTY 4x2 Tracción trasera	
R	99-04	PICKUP 3/4 TON, F-250 / SUPERDUTY 4x2 Tracción trasera	
61655	C		
R	02	FORD E-550 ECONOLINE SUPER DUTY Todos	
R	03	E-550 SUPER DUTY Todos	
F	99-04	PICKUP 1 TON, F-350 / SUPERDUTY 4x4	
F	99-04	PICKUP 3/4 TON, F-250 / SUPERDUTY 4x4	
F	99-04	PICKUP, F-450 SUPERDUTY Todos	
F	99-04	PICKUP, F-550 SUPERDUTY Todos	
61656	C		
R	99-04	FORD PICKUP 1 TON, F-350 / SUPERDUTY 4x4	
R	99-04	PICKUP 3/4 TON, F-250 / SUPERDUTY 4x4	
61657	D		
R	99-04	FORD PICKUP, F-450 SUPERDUTY Todos	
R	99-04	PICKUP, F-550 SUPERDUTY Todos	
61658	C		
R	97-04	DODGE DAKOTA Todos	
R	01-03	DURANGO 4x4	
R	01-03	DURANGO 4x2 Tracción trasera	
R	99-00	DURANGO Todos	
R	98	DURANGO 4x4	
61659	B		
R	02-05	CHEVROLET VENTURE Todos	
R	97-01	VENTURE 4x2 Tracción delantera	
R	02-04	OLDSMOBILE SILHOUETTE AWD	
R	97-04	SILHOUETTE 4x2 Tracción delantera	
R	99-05	PONTIAC MONTANA Todos	
R	97-98	TRANS SPORT Todos	
61662	B		142389
F	00-04	NISSAN FRONTIER Crew Cab Pickup, 4x2 Tracción trasera con Desert Runner	
F	98-04	FRONTIER 4x4	
F	98-99	FRONTIER 4x2 Tracción trasera Crew Cab con Desert Runner	
F	00-04	XTERRA Todos	
61663	B		141665
F	02-06	CHEVROLET AVALANCHE 2500 Todos Exc. Control de Manejo Electrónico	
F	05-06	PICKUP 1/2 TON, SILVERADO 1500 HD Todos	
F	01-03	PICKUP 1/2 TON, SILVERADO 1500 HD Todos	
F	01-09	PICKUP 1 TON, SILVERADO 3500 Todos	
F	07-10	PICKUP 1 TON, SILVERADO 3500 HD Todos	
F	05-08	PICKUP 3/4 TON, SILVERADO 2500 Todos	
F	99-04	PICKUP 3/4 TON, SILVERADO 2500 4x4	
F	01-10	PICKUP 3/4 TON, SILVERADO 2500 HD Todos PBV 9200	
F	00-11	SUBURBAN 3/4 TON, 2500 Todos Exc. Suspensión Auto Ride Z55 y Quadrateer	
F	05-06	GMC SIERRA 1500 HD Todos	
F	01-03	SIERRA 1500 HD Todos	
F	99-04	SIERRA 2500 4x4	
F	01-10	SIERRA 2500 HD Todos	
F	01-06	SIERRA 3500 Todos	
F	07-10	SIERRA 3500 HD Barra de Torsion (FrontSpringType)	
F	00-06	YUKON XL 3/4 TON Todos Exc. Sistema de Autonivelación NIVOMAT	
F	03-07	HUMMER H2 Todos	
61664	B		141353,142592
F	99-04	JEEP GRAND CHEROKEE Todos Exc. Suspensión Up Country	
61668	W		
F	94-98	DODGE RAM WAGON	
61675	C		
R	02-10	CADILLAC ESCALADE Todos Exc. Control de Manejo Electrónico	

Lista numérica

Amort.	POP	No. Alternativo	Montaje Accesorio
Pos.	Año	Aplicación	
61675	C		-continued
R	03-10	ESCALADE ESV Todos Exc. Control de Manejo Electrónico	
R	02-10	ESCALADE EXT Todos Exc. Control de Manejo Electrónico	
R	07-11	CHEVROLET AVALANCHE 1500 Todos Exc. Suspensión Z55 o ZW7	
R	02-06	AVALANCHE 1500 Todos Exc. Control de Manejo Electrónico	
R	02-06	AVALANCHE 2500 Todos Exc. Control de Manejo Electrónico	
R	00-06	SONORA Todos Exc. Suspensión Z55	
R	07-11	SUBURBAN 1/2 TON, 1500 Todos Exc. Suspensión Z55 o ZW7	
R	00-06	SUBURBAN 1/2 TON, 1500 Todos Exc. Suspensión Z55 Auto Ride	
R	00-11	SUBURBAN 3/4 TON, 2500 Todos Exc. Suspensión Auto Ride Z55 y Quadrateer	
R	07-11	TAHOE Todos Exc. Suspensión Z55 o ZW7	
R	02-06	TAHOE Todos Exc. Suspensión Z55 Auto Ride	
R	00-01	TAHOE Todos Estilo New Body, Exc. Suspensión Z55	
R	07-11	GMC YUKON Todos Exc. Suspensión Z55 o ZW7	
R	00-06	YUKON Todos Exc. Suspensión Z55 Auto Ride	
R	00-11	YUKON XL 1/2 TON Todos Exc. Suspensión Z55 Auto Ride	
R	00-11	YUKON XL 3/4 TON Todos Exc. Sistema de Autonivelación NIVOMAT	
61676	B		
R	99-04	JEEP GRAND CHEROKEE Todos	
61679	D		140126
F	87-96	DODGE DAKOTA 4x4	
61680	D		142731
F	05-12	FORD PICKUP 1 TON, F-350 / SUPERDUTY 4x4	
F	05-12	PICKUP 3/4 TON, F-250 / SUPERDUTY 4x4	
61681	X		
R	05-07	FORD PICKUP 1 TON, F-350 / SUPERDUTY Crew Cab Pickup, 4x4 Doble Rodada Trasera	
R	05-07	PICKUP 1 TON, F-350 / SUPERDUTY Extended Cab Pickup, 4x4 Doble Rodada Trasera	
R	05-07	PICKUP 1 TON, F-350 / SUPERDUTY Standard Cab Pickup, 4x4 Doble Rodada Trasera	
61682	D		
R	05-12	FORD PICKUP 1 TON, F-350 / SUPERDUTY Crew Cab Pickup, 4x4 Rodada Trasera Sencilla	
R	05-12	PICKUP 1 TON, F-350 / SUPERDUTY Extended Cab Pickup, 4x4 Rodada Trasera Sencilla	
R	05-12	PICKUP 1 TON, F-350 / SUPERDUTY Standard Cab Pickup, 4x4 Rodada Trasera Sencilla	
R	12-16	PICKUP 3/4 TON, F-250 / SUPERDUTY 4x2 Tracción trasera w/Offroad Package	
R	05-16	PICKUP 3/4 TON, F-250 / SUPERDUTY 4x4	
61683	D		143276
F	10-14	CHEVROLET VAN 1/2 TON, G / EXPRESS AWD, Barra de Torsion (FrontSpringType)	
F	03-11	VAN 1/2 TON, G / EXPRESS Barra de Torsion (FrontSpringType)	
F	06-12	VAN 3/4 TON, G / EXPRESS Todos Barra de Torsion (Suspensión de Resorte Delantero)	
F	06-12	VAN 3/4 TON, G / EXPRESS Todos Barra de Torsion (FrontSpringType)	
F	03-05	VAN 3/4 TON, G / EXPRESS Barra de Torsion (FrontSpringType)	
F	10-14	GMC VAN 1/2 TON, G / SAVANNA AWD, Barra de Torsion (FrontSpringType)	
F	04-11	VAN 1/2 TON, G / SAVANNA Barra de Torsion (FrontSpringType)	

Amort.	POP	No. Alternativo	Montaje Accesorio
Pos.	Año	Aplicación	
61683	D	-continued	143276
F 03		VAN 1/2 TON, G / SAVANNA Barra de Torsion (FrontSpringType) Barra de Torsion (Suspension de Resorte Delantera)	
F 03		VAN 1/2 TON, G / SAVANNA Barra de Torsion (FrontSpringType) Barra de Torsion (Suspension de Resorte Delantera)	
F 06-12		VAN 3/4 TON, G / SAVANNA Todos Barra de Torsion (Suspension de Resorte Delantera)	
F 06-12		VAN 3/4 TON, G / SAVANNA Todos Barra de Torsion (FrontSpringType)	
F 03-05		VAN 3/4 TON, G / SAVANNA AWD, Barra de Torsion (FrontSpringType)	
F 03-05		VAN 3/4 TON, G / SAVANNA Barra de Torsion (FrontSpringType)	
61684	D		143276
F 03-14		CHEVROLET VAN 1/2 TON, G / EXPRESS 4x2 Traccion trasera, Coil (FrontSpringType)	
F 03-14		GMC VAN 1/2 TON, G / SAVANNA 4x2 Traccion trasera, Coil (FrontSpringType)	
61685	D		143078
F 03-16		CHEVROLET VAN 1 TON, G / EXPRESS Coil (FrontSpringType)	
F 03-16		VAN 3/4 TON, G / EXPRESS Coil (FrontSpringType)	
F 03-16		GMC VAN 1 TON, G / SAVANNA Coil (FrontSpringType)	
F 03-16		VAN 3/4 TON, G / SAVANNA Coil (FrontSpringType)	
61686	D		
R 03-11		CHEVROLET VAN 1/2 TON, G / EXPRESS Todos	
R 03-11		GMC VAN 1/2 TON, G / SAVANNA Todos	
61687	D		
R 10-15		CHEVROLET EXPRESS 4500 Todos	
R 13-16		VAN 1 TON, G / EXPRESS Todos	
R 03-12		VAN 1 TON, G / EXPRESS Todos Rodada Trasera Sencilla	
R 03-12		VAN 1 TON, G / EXPRESS Todos Single Rear Wheels	
R 03-16		VAN 3/4 TON, G / EXPRESS Todos	
R 10-15		GMC SAVANA 4500 Todos	
R 13-16		VAN 1 TON, G / SAVANNA Todos	
R 03-12		VAN 1 TON, G / SAVANNA Todos Con Rodado Sencillo	
R 03-12		VAN 1 TON, G / SAVANNA Todos Single Rear Wheels	
R 03-16		VAN 3/4 TON, G / SAVANNA Todos	
61688	D		
R 03-06		CHEVROLET VAN 1 TON, G / EXPRESS Todos Doble Rodada Trasera	
R 03-06		GMC VAN 1 TON, G / SAVANNA Todos Doble Rodada Trasera	
61690	C		
R 07-15		CHEVROLET CHEYENNE PICKUP 1/2 TON, SILVERADO 1500 Todos Exc. Suspension Electronica Ajustable	
R 08-15		PICKUP 1/2 TON, SILVERADO 1500 Todos Exc. Suspension Electronica Ajustable	
R 07		PICKUP 1/2 TON, SILVERADO 1500 Base Exc. Suspension Electronica Ajustable	
R 07		PICKUP 1/2 TON, SILVERADO 1500 LT Exc. Suspension Electronica Ajustable	
R 07		PICKUP 1/2 TON, SILVERADO 1500 LTZ Exc. Suspension Electronica Ajustable	
R 07		PICKUP 1/2 TON, SILVERADO 1500 WT Exc. Suspension Electronica Ajustable	
R 08-15		GMC SIERRA 1500 Todos Exc. Suspension Electronica Ajustable	
R 07		SIERRA 1500 Denali Exc. Suspension Electronica Ajustable	
R 07		SIERRA 1500 Denali Suspension Elec. Adjustable	
R 07		SIERRA 1500 SLE Exc. Suspension Electronica Ajustable	
R 07		SIERRA 1500 SLT Exc. Suspension Electronica Ajustable	
R 07		SIERRA 1500 WT Exc. Suspension Electronica Ajustable	

Amort.	POP	No. Alternativo	Montaje Accesorio
Pos.	Año	Aplicación	
61691	D		
R 06-08		DODGE PICKUP 1/2 TON, RAM 1500 Crew Cab Pickup, 4x4	
R 06-08		PICKUP 1/2 TON, RAM 1500 Standard Cab Pickup, 4x4	
R 02-05		PICKUP 1/2 TON, RAM 1500 4x4	
61692	C		
R 06-08		DODGE PICKUP 1/2 TON, RAM 1500 Crew Cab Pickup, 4x2 Traccion trasera	
R 06-08		PICKUP 1/2 TON, RAM 1500 Standard Cab Pickup, 4x2 Traccion trasera	
R 02-05		PICKUP 1/2 TON, RAM 1500 4x2 Traccion trasera	
61693	FF		
R 05-06		FORD PICKUP, F-450 SUPERDUTY 4 X 2	
R 05-06		PICKUP, F-550 SUPERDUTY 4 X 2	
61694	FF		
R 05-06		FORD PICKUP, F-450 SUPERDUTY 4 X 4	
R 05-06		PICKUP, F-550 SUPERDUTY 4 X 4	
61695	FF		
R 06-08		HUMMER H3	
61696	D		
R 07-15		JEEP WRANGLER Todos Exc. Ruedas de 17"	
61697	D		
R 07-15		JEEP WRANGLER Todos Ruedas de 17"	
61698	FF		
F 05-06		FORD F-450 SUPER DUTY	
F 05-06		F-550 SUPER DUTY	
61699	D		140149
R 98-04		TOYOTA TACOMA Pre Runner Izquierdo	
61700	D		140149
R 98-04		TOYOTA TACOMA Pre Runner Derecho	
61701	FF		
R 03-06		HUMMER H2	
61702	FF		
F 06-08		HUMMER H3	
61703	D		
R 98-02		LINCOLN NAVIGATOR 4x4, Air (RearSpringType)	
61704	D		
R 01-06		ACURA MDX Todos	
R 03-08		HONDA PILOT Todos	
61705	FF		
R 05-06		TOYOTA TACOMA	
61706	FF		
R 05-09		TOYOTA TACOMA	
61709	D		
R 03-06		DODGE PICKUP 1 TON, RAM 3500 Standard Cab Pickup, 4x2 Traccion trasera	
R 03-06		PICKUP 3/4 TON, RAM 2500 Standard Cab Pickup, 4x2 Traccion trasera	
61710	D		
R 03-07		DODGE PICKUP 1 TON, RAM 3500 Crew Cab Pickup, 4x2 Traccion trasera	
R 03-06		PICKUP 3/4 TON, RAM 2500 Crew Cab Pickup, 4x2 Traccion trasera	
61711	D		142973
F 07-15		JEEP WRANGLER Todos	
61712	D		142731
F 06-08		DODGE PICKUP 1/2 TON, RAM 1500 4x4 Mega Cab	
61713	D		
R 05-12		FORD PICKUP 1 TON, F-350 / SUPERDUTY 4x2 Traccion trasera	
R 05-15		PICKUP 3/4 TON, F-250 / SUPERDUTY 4x2 Traccion trasera	

Amort.	POP	No. Alternativo	Montaje Accesorio
Pos.	Año	Aplicación	
61714	C		142731
F 05-08		DODGE PICKUP 3/4 TON, RAM 2500 4x4	
61715	C		
R 06-10		JEEP COMMANDER Todos	
R 05-10		GRAND CHEROKEE Todos	
61716	D		
R 03-10		DODGE PICKUP 3/4 TON, RAM 2500 4x4	
R 11-12		RAM 2500	
R 11-12		RAM 2500 (SEE DODGE RAM 2500) 4x4	
61717	C		
R 04-07		BUICK RAINIER Todos	
R 06-09		CHEVROLET TRAILBLAZER Air (RearSpringType)	
R 02-05		TRAILBLAZER Todos Suspension de Resorte de Aire Trasera	
R 02-09		GMC ENVOY Todos	
R 03-08		ISUZU ASCENDER Coil (RearSpringType)	
R 02-04		OLDSMOBILE BRAVADA Todos	
R 05-09		SAAB 9-7X Todos	
61718	D		
R 05-13		CHEVROLET EQUINOX Todos	
R 10-13		GMC TERRAIN Todos	
R 06-09		PONTIAC TORRENT Todos	
61719	FF		
R 05-09		TOYOTA TACOMA	
61720	C		
F 07-09		CHRYSLER ASPEN Todos	
F 04-09		DODGE DURANGO Todos	
61732	FF		
F 99-04		FORD PICKUP 1 TON, F-350 / SUPERDUTY Todos	
F 00-04		PICKUP 3/4 TON, F-250 / SUPERDUTY Todos	
61734	FF		
R 04-09		DODGE DURANGO Todos	
61777	D		
R 02-07		BUICK RENDEZVOUS Todos Exc. Sistema de Autonivelacion NIVOMAT	
R 01-05		PONTIAC AZTEK AWD	
Amortiguadores para Camioneta Ultra			
G63173	D		
R 93-98		TOYOTA T100 4x2 Traccion trasera	
G63183	D		
R 74		DODGE M300 Todos	
F 81-93		PICKUP 1/2 TON, W100 SERIES Todos Exc. Kit de Levantamiento	
F 61-80		PICKUP 1/2 TON, W100 SERIES Todos	
F 81-93		PICKUP 1 TON, W300 SERIES Todos Exc. Suspension Quad y Kit de Levantamiento	
F 61-80		PICKUP 1 TON, W300 SERIES Todos	
R 61-71		PICKUP 1 TON, W300 SERIES Todos	
F 90-93		PICKUP 3/4 TON, W200 SERIES Extended Cab Pickup Exc. Kit de Levantamiento	
F 88-93		PICKUP 3/4 TON, W200 SERIES Cab & Chassis Exc. Kit de Levantamiento	
F 81-93		PICKUP 3/4 TON, W200 SERIES Standard Cab Pickup Exc. Kit de Levantamiento	
F 86		PICKUP 3/4 TON, W200 SERIES Cab & Chassis Exc. Kit de Levantamiento	
F 81-83		PICKUP 3/4 TON, W200 SERIES Cab & Chassis Exc. Kit de Levantamiento	
F 81-82		PICKUP 3/4 TON, W200 SERIES Extended Cab Pickup Exc. Kit de Levantamiento	
F 69-80		PICKUP 3/4 TON, W200 SERIES Todos	
F 61-67		PICKUP 3/4 TON, W200 SERIES Todos	
F 74-93		RAMCHARGER 4x4	
F 78-80		RD200 Todos	

Lista numérica

Amort.	POP	No. Alternativo	Montaje Accesorio
Pos.	Año	Aplicación	
G63183	D	-continued	
F	74-81	PLYMOUTH TRAILDUSTER 4x4	
G63187	D		141138
F	65	FORD F-100	
F	75-77	PICKUP 3/4 TON, F-250 / SUPERDUTY 4x4 Toda la serie No. Y20000	
G63299	C		140885
R	61-67	FORD ECONOLINE Todos	
F	53-55	F SERIES Todos	
R	48-52	F SERIES Todos F-1, F-2 y F-3	
F	72-81	JEEP CJ5 Todos Exc. Kit de Levantamiento	
F	73-81	CJ5D	
F	65-71	CJ5D	
F	72-75	CJ6 Todos Exc. Kit de Levantamiento	
F	76-81	CJ7 Todos Exc. Kit de Levantamiento	
F	66-74	DJ5 Todos Exc. Kit de Levantamiento	
F	81	SCRAMBLER / CJ8 Todos	
R	71-74	WAGONEER Todos	
R	63-67	WAGONEER Todos	
R	97-02	MERCURY VILLAGER Non-ABS	
R	93-96	VILLAGER 4-Wheel ABS	
R	93-02	NISSAN QUEST Todos	
F	76-83	TOYOTA LAND CRUISER FJ40 (Código plataforma del fabricante)	
F	75	LAND CRUISER FJ40 (Código plataforma del fabricante) Fab. hasta 2/75	
F	67-74	LAND CRUISER Todos	
G63306	D		
R	69-72	CHEVROLET BLAZER 4x2 Tracción trasera	
R	64-72	CS1073	
R	64-72	CS31003	
R	63-72	PICKUP 1/2 TON, C10 Todos Resorte Trasero de Hojas Múltiples	
R	67-72	PICKUP 1 TON, C30 Todos Exc. Eje Trasero 11,000#	
R	63-72	PICKUP 3/4 TON, C20 Todos	
R	63-66	SUBURBAN 1/2 TON, 1500 Todos	
R	67-77	VAN 1/2 TON, G / EXPRESS Todos	
R	63-66	VAN 1/2 TON, P SERIES Todos	
R	76-77	VAN 1 TON, G / EXPRESS Todos	
R	75	VAN 1 TON, G / EXPRESS 110.0 (WheelBase)	
R	75	VAN 1 TON, G / EXPRESS 125.0 (WheelBase)	
R	71-74	VAN 1 TON, G / EXPRESS Todos	
R	68-72	VAN 1 TON, P SERIES Todos Exc. Eje Trasero 11,000#	
R	67-77	VAN 3/4 TON, G / EXPRESS Todos	
R	68-72	VAN 3/4 TON, P SERIES Todos	
R	70-72	GMC JIMMY Todos 4x2 Tracción trasera	
R	67-72	PICKUP 1/2 TON, C15 / C1500 Todos 4x2 Tracción trasera	
R	67-72	PICKUP 1 TON, C35/3500 Todos Exc. Eje Trasero 11,000#	
R	67-72	PICKUP 3/4 TON, C25 / C2500 Todos 4x2 Tracción trasera	
R	63-65	PICKUP 1000 SERIES Todos	
R	63-65	PICKUP 1500 SERIES Todos	
R	67-77	VAN 1/2 TON, G / SAVANNA Todos	
R	67	VAN 1/2 TON, P SERIES Todos	
R	76-77	VAN 1 TON, G / SAVANNA Todos	
R	75	VAN 1 TON, G / SAVANNA 110.0 (WheelBase)	
R	75	VAN 1 TON, G / SAVANNA 125.0 (WheelBase)	
R	71-74	VAN 1 TON, G / SAVANNA Todos	
R	68-72	VAN 1 TON, P SERIES Todos Exc. Eje Trasero 11,000#	
R	67-77	VAN 3/4 TON, G / SAVANNA Todos	
R	68-72	VAN 3/4 TON, P SERIES Todos	
R	63-65	VAN, PB 1000 SERIES Todos	
G63347	D		
F	87-91	CHEVROLET BLAZER 4x4 Automóvil Grande; Exc. Suspensión Quad y Kit de Levantamiento	
F	75-86	BLAZER 4x4 Exc. Suspensión Quad y Kit de Levantamiento	
F	73-74	BLAZER 4x4 Exc. Kit de Levantamiento	
F	69-72	BLAZER 4x4	
F	81-86	PICKUP 1/2 TON, K10 Todos Suspensión Estándar; Exc. Kit de Levantamiento	

Amortiguadores para Camioneta Ultra

Amort.	POP	No. Alternativo	Montaje Accesorio
Pos.	Año	Aplicación	
G63347	D	-continued	
F	75-80	PICKUP 1/2 TON, K10 Todos Exc. Kit de Levantamiento	
F	73-74	PICKUP 1/2 TON, K10 Todos Exc. Suspensión Quad y Kit de Levantamiento	
F	69-72	PICKUP 1/2 TON, K10 Todos	
F	87	PICKUP 1/2 TON, V10 Todos Exc. Suspensión Quad y Kit de Levantamiento	
F	81-86	PICKUP 3/4 TON, K20 Todos Suspensión Estándar; Exc. Kit de Levantamiento	
F	75-80	PICKUP 3/4 TON, K20 Todos Exc. Kit de Levantamiento	
F	69-74	PICKUP 3/4 TON, K20 Todos Exc. Suspensión Quad y Kit de Levantamiento	
F	87	PICKUP 3/4 TON, V20 Todos Exc. Suspensión Quad y Kit de Levantamiento	
F	81-86	SUBURBAN 1/2 TON, K10 Todos Suspensión Estándar; Exc. Kit de Levantamiento	
F	69-80	SUBURBAN 1/2 TON, K10 Todos Exc. Kit de Levantamiento	
F	81-86	SUBURBAN 3/4 TON, K20 Todos Suspensión Estándar; Exc. Kit de Levantamiento	
F	69-80	SUBURBAN 3/4 TON, K20 Todos Exc. Kit de Levantamiento	
F	87-88	SUBURBAN 3/4 TON, V20 Todos Exc. Suspensión Quad y Kit de Levantamiento	
F	89-91	SUBURBAN 3/4 TON, V2500 Todos Exc. Suspensión Quad y Kit de Levantamiento	
F	75-91	GMC JIMMY 4x4 Exc. Suspensión Quad y Kit de Levantamiento	
F	70-74	JIMMY Todos 4x4; Exc. Kit de Levantamiento	
F	69-86	PICKUP 1/2 TON, K15 / K1500 Todos Exc. Suspensión Quad y Kit de Levantamiento	
F	87	PICKUP 1/2 TON, V1500 Todos Exc. Kit de Levantamiento	
F	69-86	PICKUP 3/4 TON, K25 / K2500 Todos Exc. Suspensión Quad y Kit de Levantamiento	
F	87	PICKUP 3/4 TON, V2500 Todos Exc. Kit de Levantamiento	
F	69-86	SUBURBAN 1/2 TON, K15 / K1500 Todos Exc. Suspensión Quad y Kit de Levantamiento	
F	87-91	SUBURBAN 1/2 TON, V1500 Todos Exc. Kit de Levantamiento	
F	69-86	SUBURBAN 3/4 TON, K25 / K2500 Todos Exc. Suspensión Quad y Kit de Levantamiento	
F	87-91	SUBURBAN 3/4 TON, V2500 Todos Exc. Kit de Levantamiento	
G63349	B		140357
R	87-91	CHEVROLET BLAZER Todos Automóvil Grande; Exc. Suspensión Quad y Kit de Levantamiento	
R	73-86	BLAZER Todos Exc. Kit de Levantamiento	
R	73-78	CS1073	
R	75-86	PICKUP 1/2 TON, C10 Todos	
R	73-86	PICKUP 1/2 TON, K10 Todos Exc. Suspensión Quad y Kit de Levantamiento	
R	87	PICKUP 1/2 TON, R10 Todos	
R	87	PICKUP 1/2 TON, V10 Todos Exc. Suspensión Quad y Kit de Levantamiento	
R	75-86	PICKUP 3/4 TON, C20 Standard Cab Pickup	
R	75-86	PICKUP 3/4 TON, K20 Todos Exc. Suspensión Quad y Kit de Levantamiento	
R	87	PICKUP 3/4 TON, R20 Standard Cab Pickup	
R	87	PICKUP 3/4 TON, V20 Todos Exc. Suspensión Quad y Kit de Levantamiento	
R	73-86	SUBURBAN 1/2 TON, C10 Todos	
R	73-86	SUBURBAN 1/2 TON, K10 Todos Exc. Suspensión Quad y Kit de Levantamiento	
R	87-88	SUBURBAN 1/2 TON, R10 Todos	
R	89-91	SUBURBAN 1/2 TON, R1500 Todos	

Lista numérica

Amort.	POP	No. Alternativo	Montaje Accesorio
Pos.	Año	Aplicación	
G63349	B	-continued	140357
R	89-91	SUBURBAN 1/2 TON, V1500 Todos Exc. Suspensión Quad y Kit de Levantamiento	
R	73-86	SUBURBAN 3/4 TON, C20 Todos	
R	73-86	SUBURBAN 3/4 TON, K20 Todos Exc. Suspensión Quad y Kit de Levantamiento	
R	87-88	SUBURBAN 3/4 TON, R20 Todos	
R	89-91	SUBURBAN 3/4 TON, R2500 Todos	
R	87-88	SUBURBAN 3/4 TON, V20 Todos Exc. Suspensión Quad y Kit de Levantamiento	
R	89-91	SUBURBAN 3/4 TON, V2500 Todos Exc. Suspensión Quad y Kit de Levantamiento	
R	73	VAN 1/2 TON, P SERIES Todos	
R	73-78	VAN 3/4 TON, P SERIES Todos	
R	73-91	GMC JIMMY Todos Exc. Kit de Levantamiento	
R	73-86	PICKUP 1/2 TON, C15 / C1500 Todos	
R	73-86	PICKUP 1/2 TON, K15 / K1500 Todos Exc. Kit de Levantamiento	
R	87	PICKUP 1/2 TON, R1500 Todos	
R	87	PICKUP 1/2 TON, V1500 Todos Exc. Kit de Levantamiento	
R	75-86	PICKUP 3/4 TON, C25 / C2500 Cab & Chassis	
R	75-86	PICKUP 3/4 TON, C25 / C2500 Standard Cab Pickup	
R	73-74	PICKUP 3/4 TON, C25 / C2500 Todos Exc. Crew Cab y Bonus Cab	
R	73-86	PICKUP 3/4 TON, K25 / K2500 Todos Exc. Kit de Levantamiento	
R	88-89	PICKUP 3/4 TON, R2500 Todos Exc. Crew Cab y Bonus Cab	
R	87	PICKUP 3/4 TON, R2500 Cab & Chassis Exc. Crew Cab y Bonus Cab	
R	87	PICKUP 3/4 TON, R2500 Standard Cab Pickup Exc. Crew Cab y Bonus Cab	
R	87	PICKUP 3/4 TON, V2500 Todos Exc. Kit de Levantamiento	
R	73-86	SUBURBAN 1/2 TON, C15 / C1500 Todos	
R	73-86	SUBURBAN 1/2 TON, K15 / K1500 Todos Exc. Kit de Levantamiento	
R	87-91	SUBURBAN 1/2 TON, R1500 Todos	
R	87-91	SUBURBAN 1/2 TON, V1500 Todos Exc. Kit de Levantamiento	
R	75-86	SUBURBAN 3/4 TON, C25 / C2500 Todos	
R	73-74	SUBURBAN 3/4 TON, C25 / C2500 Todos Exc. Crew Cab y Bonus Cab	
R	73-86	SUBURBAN 3/4 TON, K25 / K2500 Todos Exc. Kit de Levantamiento	
R	87-91	SUBURBAN 3/4 TON, R2500 Todos	
R	87-91	SUBURBAN 3/4 TON, V2500 Todos Exc. Kit de Levantamiento	
R	73	VAN 1/2 TON, P SERIES Todos	
R	73-78	VAN 3/4 TON, P SERIES Todos	
G63350	C		140126
R	66	FORD BRONCO Todos Toda la serie #830000	
R	75-79	PICKUP 1/2 TON, F-100 4x2 Tracción trasera	
R	75-79	PICKUP 1/2 TON, F-150 4x2 Tracción trasera	
R	75-79	PICKUP 1 TON, F-350 / SUPERDUTY Extended Cab Pickup, 4x2 Tracción trasera	
R	75-79	PICKUP 3/4 TON, F-250 / SUPERDUTY Cab & Chassis, 4x2 Tracción trasera	
R	75-79	PICKUP 3/4 TON, F-250 / SUPERDUTY Standard Cab Pickup, 4x2 Tracción trasera	
R	75-91	VAN 1/2 TON, ECONOLINE / CLUB WAGON Todos	
F	71-80	INTERNATIONAL SCOUT II Todos	
G63353	C		
R	72-93	DODGE PICKUP 1/2 TON, D100 SERIES Todos	
R	72-93	PICKUP 1 TON, D300 SERIES Todos	
R	72-93	PICKUP 3/4 TON, D200 SERIES Todos	
R	74-93	RAMCHARGER 4x2 Tracción trasera	
R	76-81	PLYMOUTH TRAILDUSTER 4x2 Tracción trasera	

Lista numérica

Amort.	POP	No. Alternativo	Montaje Accesorio
Pos.	Año	Aplicación	
G63353	C	-continued	
R	74-75	TRAILDUSTER Todos	
G63355	B	140702	
F	75-84	CHEVROLET BLAZER 4x2 Tracción trasera	
F	69-74	BLAZER Todos 4x2 Tracción trasera	
F	67	C3605	
F	65-67	C20905	
F	64-78	CS1073	
F	64-78	CS31003	
F	63-86	PICKUP 1/2 TON, C10 Todos	
F	87	PICKUP 1/2 TON, R10 Todos	
F	63-86	PICKUP 1 TON, C30 Todos	
F	88-91	PICKUP 1 TON, C35/3500 Cab & Chassis Exc. Eje Rígido Delantero HD	
F	87-88	PICKUP 1 TON, R30 Todos	
F	89	PICKUP 1 TON, R3500 Standard Cab Pickup	
F	75-86	PICKUP 3/4 TON, C20 Crew Cab Pickup	
F	75-86	PICKUP 3/4 TON, C20 Standard Cab Pickup	
F	63-74	PICKUP 3/4 TON, C20 Todos	
F	88	PICKUP 3/4 TON, R20 Todos	
F	87	PICKUP 3/4 TON, R20 Crew Cab Pickup	
F	89	PICKUP 3/4 TON, R2500 4x2 Tracción trasera	
F	63-66	SUBURBAN 1/2 TON, 1500 Todos	
F	67-86	SUBURBAN 1/2 TON, C10 Todos	
F	87-88	SUBURBAN 1/2 TON, R10 Todos	
F	89-91	SUBURBAN 1/2 TON, R1500 Todos	
F	68-86	SUBURBAN 3/4 TON, C20 Todos	
F	87-88	SUBURBAN 3/4 TON, R20 Todos	
F	89-91	SUBURBAN 3/4 TON, R2500 Todos	
F	63-80	VAN 1/2 TON, P SERIES Todos	
F	68-90	VAN 1 TON, P SERIES Todos Exc. Chasis Motorhome	
F	68-89	VAN 3/4 TON, P SERIES Todos	
F	75-84	GMC JIMMY 4x2 Tracción trasera	
F	70-74	JIMMY Todos 4x2 Tracción trasera	
F	67-86	PICKUP 1/2 TON, C15 / C1500 Todos	
F	87	PICKUP 1/2 TON, R1500 Todos	
F	88-90	PICKUP 1 TON, C35/3500 Cab & Chassis Exc. Eje Rígido Delantero HD	
F	67-78	PICKUP 1 TON, C35/3500 Todos	
F	87-91	PICKUP 1 TON, R3500 Todos	
F	85-86	PICKUP 3/4 TON, C25 / C2500 Crew Cab Pickup	
F	75-86	PICKUP 3/4 TON, C25 / C2500 Cab & Chassis	
F	75-86	PICKUP 3/4 TON, C25 / C2500 Standard Cab Pickup	
F	75-83	PICKUP 3/4 TON, C25 / C2500 Crew Cab Pickup	
F	67-74	PICKUP 3/4 TON, C25 / C2500 Todos	
F	87-89	PICKUP 3/4 TON, R2500 Todos Exc. Crew Cab y Bonus Cab	
F	63-65	PICKUP 1000 SERIES Todos	
F	63-65	PICKUP 1500 SERIES Todos	
F	68-86	SUBURBAN 1/2 TON, C15 / C1500 Todos	
F	87-91	SUBURBAN 1/2 TON, R1500 Todos	
F	68-86	SUBURBAN 3/4 TON, C25 / C2500 Todos	
F	87-91	SUBURBAN 3/4 TON, R2500 Todos	
F	67-80	VAN 1/2 TON, P SERIES Todos	
F	75-90	VAN 1 TON, P SERIES Todos Exc. Chasis Motorhome	
F	73-74	VAN 1 TON, P SERIES Base Exc. Chasis Motorhome	
F	68-72	VAN 1 TON, P SERIES Todos	
F	68-89	VAN 3/4 TON, P SERIES Todos	
F	63-65	VAN, PB 1000 SERIES Todos	
G63357	D		
F	71-95	CHEVROLET VAN 1/2 TON, G / EXPRESS Todos	
F	70	VAN 1/2 TON, G / EXPRESS Todos Suspensión Delantera Independiente	
F	76-96	VAN 1 TON, G / EXPRESS Todos	
F	75	VAN 1 TON, G / EXPRESS 146.0 (WheelBase)	
F	71-74	VAN 1 TON, G / EXPRESS Todos	
F	78-95	VAN 3/4 TON, G / EXPRESS Todos Exc. PBV 8600 #	
F	71-95	VAN 3/4 TON, G / EXPRESS Todos	
F	70	VAN 3/4 TON, G / EXPRESS Todos Suspensión Delantera Independiente	

Amortiguadores para Camioneta Ultra

Amort.	POP	No. Alternativo	Montaje Accesorio
Pos.	Año	Aplicación	
G63357	D	-continued	
F	71-95	GMC VAN 1/2 TON, G / SAVANNA Todos	
F	70	VAN 1/2 TON, G / SAVANNA Todos Suspensión Delantera Independiente	
F	76-95	VAN 1 TON, G / SAVANNA Todos	
F	75	VAN 1 TON, G / SAVANNA 146.0 (WheelBase)	
F	71-74	VAN 1 TON, G / SAVANNA Todos	
F	78-95	VAN 3/4 TON, G / SAVANNA Todos Exc. PBV 8600 #	
F	78-95	VAN 3/4 TON, G / SAVANNA Todos Exc. PBV 8600#	
F	71-77	VAN 3/4 TON, G / SAVANNA Todos	
F	70	VAN 3/4 TON, G / SAVANNA Todos Suspensión Delantera Independiente	
G63359	B	140126	
F	84-86	DODGE MINI RAM Todos	
F	72-93	PICKUP 1/2 TON, D100 SERIES Todos	
F	72-93	PICKUP 3/4 TON, D200 SERIES Todos Exc. Paquete HD	
F	75-93	RAMCHARGER 4x2 Tracción trasera	
F	99-03	VAN 1/2 TON, A / B SERIES / RAM 109.3 (WheelBase) Exc. PBV 7000#	
F	81-98	VAN 1/2 TON, A / B SERIES / RAM 109.6 (WheelBase) Exc. PBV 7000#	
F	71-80	VAN 1/2 TON, A / B SERIES / RAM Todos Exc. Eje Delantero 4000#	
F	99-03	VAN 1 TON, A / B SERIES / RAM Todos	
F	71-98	VAN 1 TON, A / B SERIES / RAM Todos Exc. Eje Delantero 4000#	
F	81-03	VAN 3/4 TON, A / B SERIES / RAM Todos	
F	71-80	VAN 3/4 TON, A / B SERIES / RAM Todos Exc. Eje Delantero 4000#	
F	74-80	VAN, CB300 Todos Exc. Eje Delantero 4000#	
F	75-81	PLYMOUTH TRAILDUSTER 4x2 Tracción trasera	
F	74-83	VAN 1/2 TON, PB SERIES Todos	
F	74-83	VAN 1 TON, PB SERIES Todos Exc. Eje Delantero 4000#	
F	74-83	VAN 3/4 TON, PB SERIES Todos	
G63360	C	140126	
F	88-93	DODGE MICROBUS	
F	91-93	PICKUP 1 TON, D300 SERIES Todos Paquete HD	
F	90	PICKUP 1 TON, D300 SERIES Todos	
F	72-89	PICKUP 1 TON, D300 SERIES Todos Paquete HD	
F	72-93	PICKUP 3/4 TON, D200 SERIES Todos Paquete HD	
F	71-93	VAN 1 TON, A / B SERIES / RAM Todos Con Eje Delantero 4000#	
F	74-80	VAN, CB300 Todos Con Eje Delantero 4000#	
F	74-83	PLYMOUTH VAN 1 TON, PB SERIES Todos Con Eje Delantero 4000#	
G63366	D		
R	73-78	CHEVROLET CS31003	
R	75-86	PICKUP 1 TON, C30 Todos	
R	88-91	PICKUP 1 TON, C35/3500 Cab & Chassis Exc. Eje Rígido Delantero HD	
R	87-88	PICKUP 1 TON, R30 Todos	
R	89	PICKUP 1 TON, R3500 Standard Cab Pickup	
R	75-86	PICKUP 3/4 TON, C20 Crew Cab Pickup	
R	88	PICKUP 3/4 TON, R20 Todos	
R	87	PICKUP 3/4 TON, R20 Crew Cab Pickup	
R	89	PICKUP 3/4 TON, R2500 Todos	
R	74-80	VAN 1/2 TON, P SERIES Todos	
R	73-99	VAN 1 TON, P SERIES Todos	
R	79-89	VAN 3/4 TON, P SERIES Todos	
R	88-91	GMC PICKUP 1 TON, C35/3500 Cab & Chassis Exc. Eje Rígido Delantero HD	
R	73-78	PICKUP 1 TON, C35/3500 Todos	
R	87-91	PICKUP 1 TON, R3500 Todos	
R	85-86	PICKUP 3/4 TON, C25 / C2500 Crew Cab Pickup	
R	73-83	PICKUP 3/4 TON, C25 / C2500 Crew Cab Pickup	
R	87-89	PICKUP 3/4 TON, R2500 Crew Cab Pickup	

Lista numérica

Amort.	POP	No. Alternativo	Montaje Accesorio
Pos.	Año	Aplicación	
G63366	D	-continued	
R	74-80	VAN 1/2 TON, P SERIES Todos	
R	73-99	VAN 1 TON, P SERIES Todos	
R	79-89	VAN 3/4 TON, P SERIES Todos	
G63371	W		
R	69-72	CHEVROLET BLAZER 4x4	
R	69-72	PICKUP 1/2 TON, K10 Todos	
R	71-72	PICKUP 3/4 TON, K20 Todos	
R	71-72	SUBURBAN 1/2 TON, K10 Todos	
R	71-72	SUBURBAN 3/4 TON, K20 Todos Exc. Suspensión Quad y Kit de Levantamiento	
R	70-72	GMC JIMMY 4x4	
R	71-72	PICKUP 1/2 TON, K15 / K1500 Todos	
R	71-72	PICKUP 3/4 TON, K25 / K2500 Todos	
R	71-72	SUBURBAN 1/2 TON, K15 / K1500 Todos	
R	71-72	SUBURBAN 3/4 TON, K25 / K2500 Todos	
G63375	A	140780,142615	
F	85-05	CHEVROLET ASTRO 4x2 Tracción trasera	
F	81	BEL AIR Sedan Modelos Policía y Taxi	
F	71-75	BEL AIR Sedan Modelos Policía y Taxi	
F	71-72	BISCAYNE Todos	
F	73-96	CAPRICE Sedan Modelos Policía y Taxi	
F	71-72	CAPRICE Todos Modelos Policía y Taxi	
F	83-85	IMPALA Todos Modelos Policía y Taxi	
F	71-82	IMPALA Sedan Modelos Policía y Taxi	
F	96-02	VAN 1/2 TON, G / EXPRESS Todos	
F	97-02	VAN 1 TON, G / EXPRESS Todos	
F	96-02	VAN 3/4 TON, G / EXPRESS Todos Exc. PBV 8600 #	
F	93-02	FORD CROWN VICTORIA Police Interceptor Modelos Policía y Taxi	
F	85-05	GMC SAFARI 4x2 Tracción trasera	
F	96-02	VAN 1/2 TON, G / SAVANNA 4x2 Tracción trasera	
F	96-02	VAN 1 TON, G / SAVANNA Todos	
F	96-02	VAN 3/4 TON, G / SAVANNA Todos Exc. PBV 8600 #	
G63377	D	141137	
R	78-79	FORD BRONCO Todos Exc. Kit de Levantamiento	
R	66-77	BRONCO Todos Desde Serie #830001; Exc. Kit de Levantamiento	
R	65-78	F-100	
R	67-78	F-350 PICKUP	
R	75-79	PICKUP 1 TON, F-350 / SUPERDUTY Standard Cab Pickup, 4x2 Tracción trasera	
R	75-79	PICKUP 3/4 TON, F-250 / SUPERDUTY Extended Cab Pickup, 4x2 Tracción trasera	
R	69-74	VAN 1/2 TON, ECONOLINE / CLUB WAGON Todos	
R	69-74	VAN 1 TON, ECONOLINE / CLUB WAGON / SUPERDUTY Todos	
R	69-74	VAN 3/4 TON, ECONOLINE / CLUB WAGON / SUPERDUTY Todos	
R	76-83	JEEP CHEROKEE Todos	
F	74-83	CHEROKEE Todos	
F	82-83	CJ5 Todos Exc. Kit de Levantamiento	
F	82-86	CJ5D	
F	82-86	CJ7 Todos Exc. Kit de Levantamiento	
F	84-85	CJ10	
F	84-91	GRAND WAGONEER Todos	
R	84-91	GRAND WAGONEER Todos	
F	74-88	J10 PICKUP Todos	
R	74-88	J10 PICKUP Todos	
F	74-88	J20 PICKUP Todos	
R	74-88	J20 PICKUP Todos	
F	84-86	J100	
R	84-86	J100	
F	74-86	J164	
F	74-86	J164V	
F	82-85	SCRAMBLER / CJ8 Todos	
R	76-83	WAGONEER Todos	
F	74-83	WAGONEER Todos	
G63386	B	140780	
F	85-91	FORD B200	

Lista numérica

Amort.	POP	No. Alternativo	Montaje Accesorio
Pos.	Año	Aplicación	
G63386	B	-continued	140780
F	67-77	BRONCO Todos Desde Serie #830001; Exc. Kit de Levantamiento	
F	66	BRONCO Todos Exc. Kit de Levantamiento	
F	65-74	F-100	
F	76-79	PICKUP 1/2 TON, F-100 Todos Exc. Kit de Levantamiento	
F	75	PICKUP 1/2 TON, F-100 Todos	
F	75-79	PICKUP 1/2 TON, F-150 4x2 Tracción trasera	
F	75-79	PICKUP 1 TON, F-350 / SUPERDUTY Standard Cab Pickup, 4x2 Tracción trasera	
F	75-79	PICKUP 3/4 TON, F-250 / SUPERDUTY 4x2 Tracción trasera	
F	75-91	VAN 1 TON, ECONOLINE / CLUB WAGON / SUPERDUTY Todos Conversión a Motorhome	
F	75-91	VAN 3/4 TON, ECONOLINE / CLUB WAGON / SUPERDUTY Todos	
G63387	C		140126
R	75-76	FORD PICKUP 1/2 TON, F-100 4x4 Exc. Kit de Levantamiento	
R	76-79	PICKUP 1/2 TON, F-150 4x4 Exc. Kit de Levantamiento	
R	75	PICKUP 1/2 TON, F-150 Todos 4x4; Exc. Kit de Levantamiento	
R	79	PICKUP 1 TON, F-350 / SUPERDUTY 4x4	
R	77-79	PICKUP 3/4 TON, F-250 / SUPERDUTY Cab & Chassis, 4x4 Aplica para toda la serie No. Y20001	
R	77-79	PICKUP 3/4 TON, F-250 / SUPERDUTY Standard Cab Pickup, 4x4 Aplica para toda la serie No. Y20001	
R	75-91	VAN 1 TON, ECONOLINE / CLUB WAGON / SUPERDUTY Todos Conversión a Motorhome	
R	75-91	VAN 3/4 TON, ECONOLINE / CLUB WAGON / SUPERDUTY Todos	
G63389	D		
R	81-93	DODGE PICKUP 1/2 TON, W100 SERIES Todos Exc. Kit de Levantamiento	
R	72-80	PICKUP 1/2 TON, W100 SERIES Todos	
R	81-93	PICKUP 1 TON, W300 SERIES Todos Exc. Suspensión Quad y Kit de Levantamiento	
R	72-80	PICKUP 1 TON, W300 SERIES Todos	
R	90-93	PICKUP 3/4 TON, W200 SERIES Extended Cab Pickup Exc. Kit de Levantamiento	
R	88-93	PICKUP 3/4 TON, W200 SERIES Cab & Chassis Exc. Kit de Levantamiento	
R	81-93	PICKUP 3/4 TON, W200 SERIES Standard Cab Pickup Exc. Kit de Levantamiento	
R	86	PICKUP 3/4 TON, W200 SERIES Cab & Chassis Exc. Kit de Levantamiento	
R	81-83	PICKUP 3/4 TON, W200 SERIES Cab & Chassis Exc. Kit de Levantamiento	
R	81-82	PICKUP 3/4 TON, W200 SERIES Extended Cab Pickup Exc. Kit de Levantamiento	
R	72-80	PICKUP 3/4 TON, W200 SERIES Todos	
R	76-93	RAMCHARGER 4x4	
R	76-81	PLYMOUTH TRAILDUSTER 4x4	
G63394	D		140702
F	85-99	CHEVROLET VAN 1 TON, P SERIES Todos Chasis Motorhome c/ Suspensión Delantera Independiente	
F	74-84	VAN 1 TON, P SERIES Todos Chasis Motorhome	
F	85-99	GMC VAN 1 TON, P SERIES Todos Chasis Motorhome c/ Suspensión Delantera Independiente	
F	75-84	VAN 1 TON, P SERIES Todos Chasis Motorhome	
F	74	VAN 1 TON, P SERIES Motor Home	
G63396	W		140780
F	78-79	FORD BRONCO Todos Suspensión Quad; detrás del Eje Delantero; Exc. Kit de Levantamiento	

Amortiguadores para Camioneta Ultra

Amort.	POP	No. Alternativo	Montaje Accesorio
Pos.	Año	Aplicación	
G63396	W	-continued	140780
F	78-79	PICKUP 1/2 TON, F-150 4x4 Detrás del Eje Delantero	
F	77	PICKUP 1/2 TON, F-150 4x4	
F	75-79	PICKUP 1 TON, F-350 / SUPERDUTY Extended Cab Pickup, 4x2 Tracción trasera	
G63398	W		141138
F	78-79	FORD PICKUP 1/2 TON, F-150 Extended Cab Pickup, 4x4 Exc. Kit de Levantamiento	
F	79	PICKUP 1 TON, F-350 / SUPERDUTY 4x4	
F	77-79	PICKUP 3/4 TON, F-250 / SUPERDUTY Cab & Chassis, 4x4 Aplica para toda la serie No. Y20001	
F	77-79	PICKUP 3/4 TON, F-250 / SUPERDUTY Standard Cab Pickup, 4x4 Aplica para toda la serie No. Y20001	
G63403	B		
R	79-91	CHEVROLET VAN 1 TON, G / EXPRESS Todos PBV 9200	
F	85	VAN 1 TON, P SERIES Todos Chasis Motorhome c/ Eje de Vega Delantero en I	
R	97-04	DODGE DAKOTA Todos	
R	98-03	DURANGO Todos	
R	79-96	GMC VAN 1 TON, G / SAVANNA Cutaway Van PBV 9200	
F	85	VAN 1 TON, P SERIES Todos Chasis Motorhome c/ Eje de Vega Delantero en I	
G63404	D		141349
F	84-85	TOYOTA 4RUNNER Todos	
F	80-85	PICKUP 4x4 Exc. Kit de Levantamiento	
G63405	W		140884
F	55-56	CHEVROLET PICKUP Todos	
R	65	FORD F-100	
R	65-66	F-350 PICKUP	
R	55	F SERIES Todos F-100	
F	48-52	F SERIES Todos F-1, F-2 y F-3	
F	68-76	PICKUP P350 Todos Hasta PBV 8000#	
F	75-76	PICKUP P400 Todos Hasta PBV 8000#	
R	68	INTERNATIONAL 908C Todos	
R	68	1000C Todos Exc. Travelette c/ base de rueda de 166"	
F	68	1100C Todos Exc. Travelette c/ base de rueda de 166"	
R	68	1100C Todos Exc. Travelette c/ base de rueda de 166"	
F	68	1200C Todos Exc. Travelette c/ base de rueda de 166"	
R	68	1200C Todos Exc. Travelette c/ base de rueda de 166"	
F	68	1300C Todos Exc. Travelette c/ base de rueda de 166"	
R	68	1300C Todos Exc. Travelette c/ base de rueda de 166"	
R	68-72	M1100 / M1200 Todos	
R	69	M1400 Todos	
R	65	JEEP CJ3 Todos Exc. Kit de Levantamiento	
R	65-83	CJ5 Todos Exc. Kit de Levantamiento	
R	65-75	CJ6 Todos Exc. Kit de Levantamiento	
R	76-86	CJ7 Todos Exc. Kit de Levantamiento	
R	66-74	DJ5 Todos Exc. Kit de Levantamiento	
R	66-68	DJ6 Todos Exc. Kit de Levantamiento	
R	57-60	FC150 Todos	
F	63-65	FC170 Todos	
R	63-65	FC170 Todos	
R	63-66	GLADIATOR Todos Suspensión Delantera Independiente	
R	70-73	JEEPSTER Todos	
R	81-85	SCRAMBLER / CJ8 Todos	
R	65-67	UNIVERSAL Todos Exc. Kit de Levantamiento	
R	61-64	UNIVERSAL Todos	
G63406	B		
R	85-96	FORD PICKUP 1/2 TON, F-150 4x2 Tracción trasera	

Lista numérica

Amort.	POP	No. Alternativo	Montaje Accesorio
Pos.	Año	Aplicación	
G63406	B	-continued	
R	80-97	PICKUP 1 TON, F-350 / SUPERDUTY 4x2 Tracción trasera Exc. Doble Rodada Trasera	
R	97	PICKUP 3/4 TON, F-250 / SUPERDUTY 4x2 Tracción trasera PBV arriba de 8500#	
R	80-96	PICKUP 3/4 TON, F-250 / SUPERDUTY 4x2 Tracción trasera	
G63409	B		
R	82-85	FORD B150	
R	80-96	BRONCO Todos Exc. Kit de Levantamiento	
R	86-90	F-200	
R	80-83	PICKUP 1/2 TON, F-100 4x2 Tracción trasera	
R	80-84	PICKUP 1/2 TON, F-150 4x2 Tracción trasera	
R	90-97	PICKUP 1/2 TON, F SUPERDUTY Todos	
R	80-97	PICKUP 1 TON, F-350 / SUPERDUTY 4x2 Tracción trasera Doble Rodada Trasera	
R	97	PICKUP, F-450 SUPERDUTY Todos	
R	10	NISSAN URVAN Todos amortiguador trasero sin buje metálico	
R	07-08	URVAN Todos amortiguador trasero sin buje metálico	
G63410	C		141047
F	80-96	FORD BRONCO Todos Suspensión Quad adelante del Eje Delantero; Exc. Kit de Levantamiento	
F	83-85	F-350 PICKUP	
F	80-96	PICKUP 1/2 TON, F-150 4x4 Suspensión Quad adelante del Eje Delantero; Exc. Kit de Levantamiento	
F	80-81	PICKUP 1 TON, F-350 / SUPERDUTY 4x4	
F	80-82	PICKUP 3/4 TON, F-250 / SUPERDUTY Standard Cab Pickup, 4x4	
G63411	W		
F	77-86	CHEVROLET PICKUP 1 TON, K30 Todos	
F	90-91	PICKUP 1 TON, R3500 Todos	
F	89	PICKUP 1 TON, R3500 Cab & Chassis	
F	89	PICKUP 1 TON, R3500 Crew Cab Pickup	
F	87-88	PICKUP 1 TON, V30 Todos	
F	89-91	PICKUP 1 TON, V3000 / V3500 Todos	
F	77-86	GMC PICKUP 1 TON, K35 / K3500 Todos	
F	87-91	PICKUP 1 TON, V3000 / V3500 Todos	
G63413	C		
R	78-95	CHEVROLET VAN 1/2 TON, G / EXPRESS Todos	
R	85-95	VAN 1 TON, G / EXPRESS Extended Cargo Van	
R	85-95	VAN 1 TON, G / EXPRESS Extended Passenger Van	
R	78-95	VAN 1 TON, G / EXPRESS Standard Cargo Van	
R	78-95	VAN 1 TON, G / EXPRESS Standard Passenger Van	
R	78	VAN 1 TON, G / EXPRESS Extended Cargo Van	
R	78-95	VAN 3/4 TON, G / EXPRESS Todos Exc. PBV 8600 #	
R	84-86	DODGE MINI RAM Todos	
R	99-03	VAN 1/2 TON, A / B SERIES / RAM 109.3 (WheelBase) Exc. PBV 7000#	
R	81-98	VAN 1/2 TON, A / B SERIES / RAM 109.6 (WheelBase) Exc. PBV 7000#	
R	71-80	VAN 1/2 TON, A / B SERIES / RAM Todos	
R	99-03	VAN 1 TON, A / B SERIES / RAM Todos	
R	94-98	VAN 1 TON, A / B SERIES / RAM Todos Exc. Eje Delantero 4000#	
R	71-93	VAN 1 TON, A / B SERIES / RAM Todos	
R	71-03	VAN 3/4 TON, A / B SERIES / RAM Todos	
R	74-80	VAN, CB300 Todos	
R	78-95	GMC VAN 1/2 TON, G / SAVANNA Todos	

Lista numérica

Amort.	POP	No. Alternativo	Montaje Accesorio
Pos.	Año	Aplicación	
G63413 C -continued			
R	85-96	VAN 1 TON, G / SAVANNA Extended Cargo Van	
R	85-96	VAN 1 TON, G / SAVANNA Extended Passenger Van	
R	79-96	VAN 1 TON, G / SAVANNA Standard Cargo Van	
R	79-96	VAN 1 TON, G / SAVANNA Standard Passenger Van	
R	78	VAN 1 TON, G / SAVANNA Cutaway Van	
R	78-95	VAN 3/4 TON, G / SAVANNA Todos Exc. PBV 8600 #	
R	74-83	PLYMOUTH VAN 1/2 TON, PB SERIES Todos	
R	74-83	VAN 1 TON, PB SERIES Todos	
R	74-83	VAN 3/4 TON, PB SERIES Todos	
G63414 A 140780			
F	82-85	FORD B150	
F	92	B200	
F	97	BRONCO	
F	80-96	BRONCO Todos Con o sin Suspensión Quad detrás del Eje Delantero; Exc. Kit de Levantamiento	
F	89	BRONCO II Todos Fab. hasta 2/89; Vehículos con perno 10mm y 12mm en montaje inferior trasero	
F	84-88	BRONCO II Todos Con Perno de 10mm en Montaje Inferior Trasero	
F	86-90	F-200	
F	99-00	F-350 PICKUP	
F	86-97	P350 MICROBUS	
F	80-83	PICKUP 1/2 TON, F-100 4x2 Tracción trasera	
F	80-96	PICKUP 1/2 TON, F-150 4x4 Con o sin Suspensión Quad detrás del Eje Delantero; Exc. Kit de Levantamiento	
F	80-96	PICKUP 1/2 TON, F-150 4x2 Tracción trasera	
F	80-97	PICKUP 1 TON, F-350 / SUPERDUTY 4x2 Tracción trasera	
F	97	PICKUP 3/4 TON, F-250 / SUPERDUTY 4x2 Tracción trasera PBV arriba de 8500#	
F	80-96	PICKUP 3/4 TON, F-250 / SUPERDUTY 4x2 Tracción trasera	
F	87-89	RANGER Todos Exc. Opción High Ryder	
F	83-86	RANGER Todos	
F	02-06	NISSAN URVAN Todos	
G63416 D 140780			
F	86	FORD F-200	
F	82-85	PICKUP 1 TON, F-350 / SUPERDUTY 4x4 Montaje Inferior Delantero Tipo Abrazadera Exc. Doble Rodado o Kit de Levantamiento	
F	83-86	PICKUP 3/4 TON, F-250 / SUPERDUTY 4x4 Montaje Inferior Delantero Tipo Abrazadera Exc. Doble Rodado o Kit de Levantamiento	
F	80-82	PICKUP 3/4 TON, F-250 / SUPERDUTY Extended Cab Pickup, 4x4	
G63418 D 141356			
F	82	DODGE D50 4x4	
F	83-86	PICKUP, RAM 50 4x4	
F	87-89	RAIDER Todos	
F	83-94	MITSUBISHI MIGHTY MAX 4x4	
F	83-91	MONTERO Todos	
G63419 D			
R	82	DODGE D50 4x4	
R	87-93	PICKUP, RAM 50 4x4	
R	83-94	MITSUBISHI MIGHTY MAX 4x4	
G63420 C			
R	83-88	FORD RANGER 4x4	
G63421 A 140455			
F	05	CHEVROLET BLAZER Base, 4x2 Tracción trasera	
F	96-04	BLAZER LS, 4x2 Tracción trasera	
F	95-02	BLAZER LT, 4x2 Tracción trasera	
F	95-99	BLAZER Base, 4x2 Tracción trasera	
F	95-97	BLAZER Deluxe, 4x2 Tracción trasera	
F	83-94	BLAZER, S MODELS 4x2 Tracción trasera	
F	94-03	S10 LS, 4x2 Tracción trasera	

Amortiguadores para Camioneta Ultra

Amort.	POP	No. Alternativo	Montaje Accesorio
Pos.	Año	Aplicación	
G63421 A -continued 140455			
F	82-03	S10 Base, 4x2 Tracción trasera	
F	99	S10 Xtreme, 4x2 Tracción trasera	
F	92-93	S10 EL, 4x2 Tracción trasera	
F	83-92	S10 Tahoe, 4x2 Tracción trasera	
F	88-90	S10 Durango, 4x2 Tracción trasera	
F	82-86	S10 Durango, 4x2 Tracción trasera	
F	72-82	FORD COURIER Todos	
F	92-04	GMC JIMMY 4x2 Tracción trasera	
F	83-91	S15 JIMMY 4x2 Tracción trasera	
F	04	SONOMA / S15 Todos 4x2 Tracción trasera	
F	82-03	SONOMA / S15 4x2 Tracción trasera	
F	78-87	SPRINT / CABALLERO 4x2 Tracción trasera	
F	71-77	SPRINT / CABALLERO Todos	
F	96-00	ISUZU HOMBRE 4x2 Tracción trasera Exc. Chasis Deportivo	
F	72-76	MAZDA B1600 Todos	
F	77-78	B1800 Todos	
F	79-84	B2000 Todos	
F	82-84	B2200 Todos	
G63422 A			
R	05	CHEVROLET BLAZER Base, 4x4	
R	05	BLAZER Base, 4x2 Tracción trasera	
R	96-04	BLAZER LS, 4x4	
R	96-04	BLAZER LS, 4x2 Tracción trasera	
R	95-02	BLAZER LT, 4x2 Tracción trasera	
R	95-01	BLAZER LT, 4x4	
R	95-99	BLAZER Base, 4x4	
R	95-99	BLAZER Base, 4x2 Tracción trasera	
R	95-97	BLAZER Deluxe, 4x2 Tracción trasera	
R	83-94	BLAZER, S MODELS Todos	
R	99-04	S10 LS, 4x4	
R	99-03	S10 Base, 4x4	
R	99-03	S10 Base, 4x2 Tracción trasera	
R	99-03	S10 LS, 4x2 Tracción trasera	
R	94-98	S10 LS	
R	82-98	S10 Base	
R	92-93	S10 EL	
R	83-92	S10 Tahoe	
R	88-90	S10 Durango	
R	82-86	S10 Durango	
R	92-05	GMC JIMMY Todos	
R	83-91	S15 JIMMY Todos	
R	82-04	SONOMA / S15 Todos	
R	91	SYCLONE Todos	
R	92-93	TYPHOON Todos	
R	98-00	ISUZU HOMBRE Todos	
R	96-97	HOMBRE 4x2 Tracción trasera	
R	96-01	OLDSMOBILE BRAVADA Todos	
R	91-94	BRAVADA Todos	
G63423 B			
F	05	CHEVROLET BLAZER Base, 4x4	
F	96-04	BLAZER LS, 4x4	
F	95-01	BLAZER LT, 4x4	
F	95-99	BLAZER Base, 4x4	
F	83-94	BLAZER, S MODELS 4x4	
F	94-04	S10 LS, 4x4	
F	83-03	S10 Base, 4x4	
F	92-93	S10 EL, 4x4	
F	83-92	S10 Tahoe, 4x4	
F	88-90	S10 Durango, 4x4	
F	83-86	S10 Durango, 4x4	
F	92-05	GMC JIMMY 4x4	
F	83-91	S15 JIMMY 4x4	
F	83-04	SONOMA / S15 4x4	
F	91	SYCLONE Todos	
F	92-93	TYPHOON Todos	
F	99-00	ISUZU HOMBRE 4x4	
F	96-98	HOMBRE 4x2 Tracción trasera Chasis Deportivo	
F	98	HOMBRE 4x4 Chasis Deportivo	
F	96-01	OLDSMOBILE BRAVADA Todos	
F	91-94	BRAVADA Todos	
G63424 A 141353,142592			
F	84-01	JEEP CHEROKEE Todos	
F	86-92	COMANCHE Todos	
F	92	GRAND CHEROKEE	
F	93-98	GRAND CHEROKEE Todos	
F	93	GRAND WAGONEER 4x4 Exc. Suspensión Up Country	
F	84-90	WAGONEER Todos	
G63425 B			
R	84-01	JEEP CHEROKEE Todos	
R	84-90	WAGONEER Todos	
G63426 B			
R	90-95	CHRYSLER TOWN & COUNTRY Todos	

Lista numérica

Amort.	POP	No. Alternativo	Montaje Accesorio
Pos.	Año	Aplicación	
G63426 B -continued			
R	84-95	DODGE CARAVAN / GRAND CARAVAN Todos	
R	87-88	MINI RAM Todos	
R	84-95	PLYMOUTH VOYAGER / GRAND VOYAGER Todos	
G63427 C			
R	89	FORD BRONCO II Todos Fab. hasta 2/89; Vehículos con perno 10mm y 12mm en montaje inferior trasero	
R	84-88	BRONCO II Todos Con Perno de 10mm en Montaje Inferior Trasero	
R	89	RANGER 4x2 Tracción trasera Fab. hasta 2/89; Vehículos con perno 10mm y 12mm en montaje inferior trasero	
R	83-88	RANGER 4x2 Tracción trasera	
G63432 D 141349,140169			
F	88-90	TOYOTA LAND CRUISER Todos	
F	81-87	LAND CRUISER FJ60 (Código plataforma del fabricante), Sport Utility	
G63434 W 141439			
R	95	LAND ROVER RANGE ROVER County Classic Exc. Suspensión con Nivelación Neumática	
R	94	RANGE ROVER Coil (RearSpringType)	
G63437 W			
F	87-91	CHEVROLET BLAZER 4x4 Automóvil Grande; Kit de Levantamiento de 4"; Exc. Suspensión Quad	
F	73-86	BLAZER 4x4 Con Kit de Levantamiento de 4"; Exc. Suspensión Quad	
F	73-86	PICKUP 1/2 TON, K10 Todos Con Kit de Levantamiento de 4"; Exc. Suspensión Quad	
F	87	PICKUP 1/2 TON, V10 Todos Con Kit de Levantamiento de 4"; Exc. Suspensión Quad	
F	73-86	PICKUP 3/4 TON, K20 Todos Con Kit de Levantamiento de 4"; Exc. Suspensión Quad	
F	87	PICKUP 3/4 TON, V20 Todos Con Kit de Levantamiento de 4"; Exc. Suspensión Quad	
F	73-86	SUBURBAN 1/2 TON, K10 Todos Con Kit de Levantamiento de 4"; Exc. Suspensión Quad	
F	89-91	SUBURBAN 1/2 TON, V1500 4x4 Con Kit de Levantamiento de 4"; Exc. Suspensión Quad	
F	73-86	SUBURBAN 3/4 TON, K20 Todos Con Kit de Levantamiento de 4"; Exc. Suspensión Quad	
F	87-88	SUBURBAN 3/4 TON, V20 Todos Con Kit de Levantamiento de 4"; Exc. Suspensión Quad	
F	89-91	SUBURBAN 3/4 TON, V2500 Todos Con Kit de Levantamiento de 4"; Exc. Suspensión Quad	
F	75-91	GMC JIMMY 4x4 Con Kit de Levantamiento de 4"; Exc. Suspensión Quad	
F	73-74	JIMMY Todos Con Kit de Levantamiento de 4"; Exc. Suspensión Quad	
F	73-86	PICKUP 1/2 TON, K15 / K1500 Todos Con Kit de Levantamiento de 4"; Exc. Suspensión Quad	
F	87	PICKUP 1/2 TON, V1500 Todos Con Kit de Levantamiento de 4"; Exc. Suspensión Quad	
F	73-86	PICKUP 3/4 TON, K25 / K2500 Todos Con Kit de Levantamiento de 4"; Exc. Suspensión Quad	
F	87	PICKUP 3/4 TON, V2500 Todos Con Kit de Levantamiento de 4"; Exc. Suspensión Quad	
F	73-86	SUBURBAN 1/2 TON, K15 / K1500 Todos Con Kit de Levantamiento de 4"; Exc. Suspensión Quad	
F	87-91	SUBURBAN 1/2 TON, V1500 Todos Con Kit de Levantamiento de 4"; Exc. Suspensión Quad	
F	73-86	SUBURBAN 3/4 TON, K25 / K2500 Todos Con Kit de Levantamiento de 4"; Exc. Suspensión Quad	

Lista numérica

Amort.	POP	No. Alternativo	Montaje Accesorio
Pos.	Año	Aplicación	
G63437	W	-continued	
F	87-91	SUBURBAN 3/4 TON, V2500 Todos Con Kit de Levantamiento de 4"; Exc. Suspensión Quad	
G63438	D	140357	
R	87-90	CHEVROLET BLAZER 4x4 Automóvil Grande; Kit de Levantamiento de 4"; Exc. Suspensión Quad	
R	73-86	BLAZER 4x4 Con Kit de Levantamiento de 4"; Exc. Suspensión Quad	
R	73-86	PICKUP 1/2 TON, K10 Todos Con Kit de Levantamiento de 4"; Exc. Suspensión Quad	
R	87	PICKUP 1/2 TON, V10 Todos Con Kit de Levantamiento de 4"; Exc. Suspensión Quad	
R	73-86	PICKUP 3/4 TON, K20 Todos Con Kit de Levantamiento de 4"; Exc. Suspensión Quad	
R	87	PICKUP 3/4 TON, V20 Todos Con Kit de Levantamiento de 4"; Exc. Suspensión Quad	
R	73-86	SUBURBAN 1/2 TON, K10 Todos Con Kit de Levantamiento de 4"; Exc. Suspensión Quad	
R	73-86	SUBURBAN 3/4 TON, K20 Todos Con Kit de Levantamiento de 4"; Exc. Suspensión Quad	
R	87-88	SUBURBAN 3/4 TON, V20 Todos Con Kit de Levantamiento de 4"; Exc. Suspensión Quad	
R	89-91	SUBURBAN 3/4 TON, V2500 Todos Con Kit de Levantamiento de 4"; Exc. Suspensión Quad	
R	73-91	GMC JIMMY Todos Con Kit de Levantamiento de 4"; Exc. Suspensión Quad	
R	73-86	PICKUP 1/2 TON, K15 / K1500 Todos Con Kit de Levantamiento de 4"; Exc. Suspensión Quad	
R	87	PICKUP 1/2 TON, V1500 Todos Con Kit de Levantamiento de 4"; Exc. Suspensión Quad	
R	73-86	PICKUP 3/4 TON, K25 / K2500 Todos Con Kit de Levantamiento de 4"; Exc. Suspensión Quad	
R	87	PICKUP 3/4 TON, V2500 Todos Con Kit de Levantamiento de 4"; Exc. Suspensión Quad	
R	73-86	SUBURBAN 1/2 TON, K15 / K1500 Todos Con Kit de Levantamiento de 4"; Exc. Suspensión Quad	
R	87-91	SUBURBAN 1/2 TON, V1500 Todos Con Kit de Levantamiento de 4"; Exc. Suspensión Quad	
R	73-86	SUBURBAN 3/4 TON, K25 / K2500 Todos Con Kit de Levantamiento de 4"; Exc. Suspensión Quad	
R	87-91	SUBURBAN 3/4 TON, V2500 Todos Con Kit de Levantamiento de 4"; Exc. Suspensión Quad	
G63439	D		
R	80-86	FORD PICKUP 1/2 TON, F-150 Todos Kit de Levantamiento de 3-4"	
G63440	D		
R	65	JEEP CJ3 Todos Kit de Levantamiento de 2-4"	
R	82-83	CJ5 Todos Kit de Levantamiento de 3-4"	
R	65-81	CJ5 Todos Kit de Levantamiento de 2-4"	
R	65-75	CJ6 Todos Kit de Levantamiento de 2-4"	
R	82-86	CJ7 Todos Kit de Levantamiento de 3-4"	
R	76-81	CJ7 Todos Kit de Levantamiento de 2-4"	
R	66-74	DJ5 Todos Kit de Levantamiento de 2-4"	
R	66-68	DJ6 Todos Kit de Levantamiento de 2-4"	
R	65-67	UNIVERSAL Todos Kit de Levantamiento de 2-4"	
R	80-83	TOYOTA PICKUP 4x4 Kit de Levantamiento de 2-3"	
G63441	D		
R	80-88	FORD BRONCO Todos Kit de Levantamiento de 3-4"	

Amortiguadores para Camioneta Ultra

Amort.	POP	No. Alternativo	Montaje Accesorio
Pos.	Año	Aplicación	
G63441	D	-continued	
R	78-79	BRONCO Todos Kit de Levantamiento de 3 1/2-4" Exc. Suspensión Quad	
R	66-77	BRONCO Todos Kit de Levantamiento de 4-5"	
F	82-83	JEEP CJ5 Todos Kit de Levantamiento de 2-4"	
F	82-86	CJ7 Todos Kit de Levantamiento de 2-4"	
G63443	D		
R	82-83	JEEP CJ5 Todos Kit de Levantamiento de 2"	
F	66-81	CJ5 Todos Kit de Levantamiento de 2-4"	
F	66-75	CJ6 Todos Kit de Levantamiento de 2-4"	
R	82-86	CJ7 Todos Kit de Levantamiento de 2"	
F	76-81	CJ7 Todos Kit de Levantamiento de 2-4"	
F	66-74	DJ5 Todos Kit de Levantamiento de 2-4"	
F	66-68	DJ6 Todos Kit de Levantamiento de 2-4"	
F	65-67	UNIVERSAL Todos Kit de Levantamiento de 2-4"	
G63444	D	141041	
F	80-83	TOYOTA PICKUP 4x4 Kit de Levantamiento de 2-3"	
G63445	D	140780	
F	80-86	FORD BRONCO Todos Kit de Levantamiento de 3-4", Suspensión Quad detrás del Eje Delantero	
F	78-79	BRONCO Todos Derecho Kit de Levantamiento de 3 1/2-4" Exc. Suspensión Quad	
F	66-77	BRONCO Todos Kit de Levantamiento de 4-5"	
F	77-79	PICKUP 1/2 TON, F-100 Todos Kit de Levantamiento de 3-4" Exc. Suspensión Quad	
F	80-86	PICKUP 1/2 TON, F-150 Todos Kit de Levantamiento de 3-4"	
F	77-79	PICKUP 1/2 TON, F-150 Cab & Chassis, 4x4 Kit de Levantamiento de 3-4" Exc. Suspensión Quad	
F	77-79	PICKUP 1/2 TON, F-150 Standard Cab Pickup, 4x4 Kit de Levantamiento de 3-4" Exc. Suspensión Quad	
G63446	W	141047	
F	80-86	FORD BRONCO Todos Kit de Levantamiento de 3-4", Suspensión Quad adelante del Eje Delantero	
F	80-86	PICKUP 1/2 TON, F-150 4x4 Suspensión Quad c/ Kit de Levantamiento de 3-4" adelante del Eje Delantero	
G63447	D	140780	
F	78-79	FORD BRONCO Todos Izquierdo Kit de Levantamiento de 3 1/2-4" Exc. Suspensión Quad	
R	77-79	PICKUP 1/2 TON, F-100 Todos 4x4 Kit de Levantamiento de 3-4" Exc. Suspensión Quad	
R	75-76	PICKUP 1/2 TON, F-100 4x4 Kit de Levantamiento de 3 1/2-4"	
R	77-79	PICKUP 1/2 TON, F-150 Cab & Chassis, 4x4 Kit de Levantamiento de 3-4" Exc. Suspensión Quad	
R	77-79	PICKUP 1/2 TON, F-150 Standard Cab Pickup, 4x4 Kit de Levantamiento de 3-4" Exc. Suspensión Quad	
R	76	PICKUP 1/2 TON, F-150 Cab & Chassis, 4x4 Kit de Levantamiento de 3-4" Exc. Suspensión Quad	
R	76	PICKUP 1/2 TON, F-150 Standard Cab Pickup, 4x4 Kit de Levantamiento de 3-4" Exc. Suspensión Quad	
R	75	PICKUP 1/2 TON, F-150 Cab & Chassis 4x4; Kit de Levantamiento de 3-4" Exc. Suspensión Quad	
R	75	PICKUP 1/2 TON, F-150 Standard Cab Pickup 4x4; Kit de Levantamiento de 3-4" Exc. Suspensión Quad	
G63454	B		
R	90-05	CHEVROLET ASTRO Todos	
R	85-89	ASTRO 4x2 Tracción trasera	
R	90-05	GMC SAFARI Todos	
R	85-89	SAFARI 4x2 Tracción trasera	

Lista numérica

Amort.	POP	No. Alternativo	Montaje Accesorio
Pos.	Año	Aplicación	
G63454	B	-continued	
R	86-89	VOLKSWAGEN VANAGON 4x4	
G63455	B		
F	87-90	FORD F-200	
F	94-97	F-350 PICKUP	
F	86-92	F-350 PICKUP	
F	65-78	F-350 PICKUP	
F	86-97	PICKUP 1 TON, F-350 / SUPERDUTY 4x4	
F	97-98	PICKUP 3/4 TON, F-250 / SUPERDUTY 4x4 PBV arriba de 8500#	
F	87-96	PICKUP 3/4 TON, F-250 / SUPERDUTY 4x4	
R	72-01	VOLKSWAGEN COMBI	
R	95-01	COMBI Todos	
R	52-77	COMBI CARAVEL	
R	72-01	COMBI PANEL	
G63456	D		
R	94-97	FORD F-350 PICKUP	
R	86-92	F-350 PICKUP	
R	86-97	PICKUP 1 TON, F-350 / SUPERDUTY 4x4 Exc. Doble Rodada Trasera	
G63457	C	140126	
F	86-97	FORD AEROSTAR 4x2 Tracción trasera	
G63460	C		
R	87-96	DODGE DAKOTA 4x2 Tracción trasera	
G63461	C		
R	80-96	FORD PICKUP 1/2 TON, F-150 4x4 Exc. Kit de Levantamiento	
R	86-97	PICKUP 1 TON, F-350 / SUPERDUTY 4x4 Doble Rodada Trasera	
R	82-85	PICKUP 1 TON, F-350 / SUPERDUTY 4x4 Montaje Inferior Delantero Tipo Abrazadera Exc. Doble Rodado o Kit de Levantamiento	
R	80-81	PICKUP 1 TON, F-350 / SUPERDUTY 4x4 Doble Rodada Trasera	
R	97	PICKUP 3/4 TON, F-250 / SUPERDUTY 4x4 PBV arriba de 8500#	
R	86-96	PICKUP 3/4 TON, F-250 / SUPERDUTY 4x4	
R	82-85	PICKUP 3/4 TON, F-250 / SUPERDUTY 4x4 Montaje Inferior Delantero Tipo Abrazadera Exc. Doble Rodado o Kit de Levantamiento	
R	80-81	PICKUP 3/4 TON, F-250 / SUPERDUTY 4x4	
G63479	B	140524	
F	86-89	TOYOTA 4RUNNER Todos	
F	86-95	PICKUP 4x4 Exc. Kit de Levantamiento	
F	93-98	T100 4x4	
G63484	D	140524	
R	84-89	TOYOTA VAN Coil (RearSpringType)	
R	88	VAN WAGON Coil (FrontSpringType), Coil (RearSpringType)	
G63488	A		
R	88-99	CHEVROLET PICKUP 1/2 TON, C15 / C1500 Todos	
R	88-99	PICKUP 1/2 TON, K15 / K1500 Todos	
R	01-03	PICKUP 1 TON, C35/3500 Base Eje Delantero Rígido HD	
R	92-00	PICKUP 1 TON, C35/3500 Crew Cab Pickup Eje Delantero Rígido HD	
R	88-00	PICKUP 1 TON, C35/3500 Extended Cab Pickup Eje Delantero Rígido HD	
R	88-90	PICKUP 1 TON, C35/3500 Standard Cab Pickup Eje Delantero Rígido HD	
R	88-00	PICKUP 1 TON, K35 / K3500 Todos	
R	88-00	PICKUP 3/4 TON, C25 / C2500 Todos	
R	88-00	PICKUP 3/4 TON, K25 / K2500 Todos	
R	01-02	GMC C3500	
R	88-99	PICKUP 1/2 TON, C15 / C1500 Todos	

Lista numérica

Amort.	POP	No. Alternativo	Montaje Accesorio
Pos.	Año	Aplicación	
G63488 A -continued			
R	88-99	PICKUP 1/2 TON, K15 / K1500	Todos
R	92-00	PICKUP 1 TON, C35/3500 Crew Cab Pickup Eje Delantero Rígido HD	
R	88-00	PICKUP 1 TON, C35/3500 Extended Cab Pickup Eje Delantero Rígido HD	
R	88-00	PICKUP 1 TON, C35/3500 Standard Cab Pickup Eje Delantero Rígido HD	
R	88-00	PICKUP 1 TON, K35 / K3500 Todos	
R	88-00	PICKUP 3/4 TON, C25 / C2500	Todos
R	88-00	PICKUP 3/4 TON, K25 / K2500	Todos
G63489 A 141277			
F	92-96	CHEVROLET 400SS PICKUP	
F	96-97	BOSS TRUCK	
F	90-96	MICROBUS	
F	88-99	PICKUP 1/2 TON, C15 / C1500	Todos
F	92-00	PICKUP 1 TON, C35/3500 Crew Cab Pickup Eje Delantero Rígido HD	
F	88-00	PICKUP 1 TON, C35/3500 Extended Cab Pickup Eje Delantero Rígido HD	
F	88-00	PICKUP 1 TON, C35/3500 Standard Cab Pickup Eje Delantero Rígido HD	
F	88-00	PICKUP 3/4 TON, C25 / C2500	Todos
F	92-99	SUBURBAN 1/2 TON, C15 / C1500	Todos
F	92-99	SUBURBAN 3/4 TON, C25 / C2500	Todos
F	95-00	TAHOE 4x2 Tracción trasera Old Body Style	
F	88-99	GMC PICKUP 1/2 TON, C15 / C1500 Todos	
F	92-00	PICKUP 1 TON, C35/3500 Crew Cab Pickup Eje Delantero Rígido HD	
F	88-00	PICKUP 1 TON, C35/3500 Extended Cab Pickup Eje Delantero Rígido HD	
F	88-00	PICKUP 1 TON, C35/3500 Standard Cab Pickup Eje Delantero Rígido HD	
F	88-00	PICKUP 3/4 TON, C25 / C2500	Todos
F	92-99	SUBURBAN 1/2 TON, C15 / C1500	Todos
F	92-99	SUBURBAN 3/4 TON, C25 / C2500	Todos
F	92-99	YUKON 4x2 Tracción trasera	
G63490 D			
R	86-88	FORD AEROSTAR 4x2 Tracción trasera	
R	87-95	JEEP WRANGLER YJ (Código plataforma del fabricante)	
G63491 C 140524			
R	69-72	NISSAN 521 PICKUP Todos	
R	72-79	620 PICKUP Todos	
R	86	720 PICKUP 4x2 Tracción trasera Fabricado antes de 8/86	
R	82-85	720 PICKUP 4x2 Tracción trasera	
R	80-81	720 PICKUP Todos	
R	65-93	PICKUP	
G63492 B 141137			
R	81-82	CHEVROLET LUV PICKUP Todos	
R	87-89	DODGE RAIDER 2.6L 4Cyl L (156) Exc. Sport Utility	
F	61-67	FORD ECONOLINE Todos	
R	81-95	ISUZU PICKUP 4x2 Tracción trasera	
R	86-92	JEEP COMANCHE Todos	
F	66-73	WAGONEER Todos	
F	63-65	WAGONEER Todos Exc. Suspensión Independiente Delantera	
R	83-89	MITSUBISHI MONTERO 2.6L 4Cyl L (156)	
R	97-99	MONTERO SPORT Todos	
R	82-86	NISSAN 720 PICKUP 4x4	
R	00-04	FRONTIER Crew Cab Pickup, 4x2 Tracción trasera con Desert Runner	
R	98-04	FRONTIER 4x4	
R	98-99	FRONTIER 4x2 Tracción trasera Crew Cab con Desert Runner	
R	87-95	PATHFINDER Todos Exc. Suspensión Electrónica Ajustable	
R	65-94	PICKUP	
R	00-04	XTERRA Todos	
R	84-87	TOYOTA LAND CRUISER FJ60 (Código plataforma del fabricante), Sport Utility	
R	76-83	LAND CRUISER Todos	
R	75	LAND CRUISER Todos Fab. desde 1/75	
R	69-74	LAND CRUISER Todos	

Amortiguadores para Camioneta Ultra

Amort.	POP	No. Alternativo	Montaje Accesorio
Pos.	Año	Aplicación	
G63492 B -continued 141137			
R	85-92	PICKUP 4x2 Tracción trasera 1 Ton	
R	80-83	PICKUP 4x4 Exc. Kit de Levantamiento	
G63494 A 140149			
R	84-89	TOYOTA 4RUNNER Todos	
R	84-95	PICKUP 4x4 Exc. Kit de Levantamiento	
R	98-04	TACOMA Pre Runner Exc. Upgrade HD	
R	95-04	TACOMA 4x4 Exc. Upgrade HD	
G63495 D 141350			
F	87-91	ISUZU TROOPER Todos	
F	86-87	MAZDA B2000 4x2 Tracción trasera	
F	87-93	B2200 4x2 Tracción trasera	
F	87-93	B2600 4x2 Tracción trasera	
G63499 D			
R	87-96	DODGE DAKOTA 4x4	
G63500 D 140780			
F	79-81	FORD B100	
F	73-74	B100	
F	75-78	B150	
F	75-91	VAN 1/2 TON, ECONOLINE / CLUB WAGON Todos	
G63502 C			
R	90-97	FORD AEROSTAR Todos	
R	89	AEROSTAR 4x2 Tracción trasera	
G63506 W 141448			
F	99	LAND ROVER DISCOVERY SD	
F	99	DISCOVERY SE7	
F	94-98	DISCOVERY Todos	
F	95	RANGE ROVER County Classic Exc. Suspensión con Nivelación Neumática	
F	94	RANGE ROVER County	
G63510 D 140149			
R	88-90	TOYOTA LAND CRUISER Todos	
G63511 D 141353			
F	78-79	FORD BRONCO Todos Suspensión Quad Amortiguador Largo; Exc. Kit de Levantamiento	
F	78-79	PICKUP 1/2 TON, F-150 Custom, 4x4 Suspensión Quad Amortiguador Largo; Exc. Kit de Levantamiento	
F	78-79	PICKUP 1/2 TON, F-150 Ranger Lariat, 4x4 Suspensión Quad Amortiguador Largo; Exc. Kit de Levantamiento	
F	78-79	PICKUP 1/2 TON, F-150 Ranger, 4x4 Suspensión Quad Amortiguador Largo; Exc. Kit de Levantamiento	
F	78	PICKUP 1/2 TON, F-150 Base, 4x4 Suspensión Quad Amortiguador Largo; Exc. Kit de Levantamiento	
F	78	PICKUP 1/2 TON, F-150 Northland, 4x4 Suspensión Quad Amortiguador Largo; Exc. Kit de Levantamiento	
F	87-95	JEEP WRANGLER YJ (Código plataforma del fabricante)	
G63524 C			
R	89-97	FORD RANGER 4x4	
R	95-96	MAZDA B2300 4x4	
R	94-97	B3000 4x4	
R	94-97	B4000 4x4	
G63525 A			
R	90	FORD BRONCO II Todos	
R	89	BRONCO II Todos Fab. desde 2/89; Vehículos con perno de 12mm en montaje inferior trasero	
R	90-97	RANGER 4x2 Tracción trasera	
R	89	RANGER 4x2 Tracción trasera Fab. desde 2/89; Vehículos con perno de 12mm en montaje inferior trasero	
R	94-97	MAZDA B2300 4x2 Tracción trasera	
R	94-97	B3000 4x2 Tracción trasera	
R	94-97	B4000 4x2 Tracción trasera	
G63547 D 141350			
F	90-95	TOYOTA 4RUNNER Todos	
G63548 C 140921			
R	90-95	TOYOTA 4RUNNER Todos	
G63604 W			
R	89	DODGE RAIDER Sport Utility, 3.0L 6Cyl V (181)	

Lista numérica

Amort.	POP	No. Alternativo	Montaje Accesorio
Pos.	Año	Aplicación	
G63604 W -continued			
R	89-91	MITSUBISHI MONTERO 3.0L 6Cyl V (181)	
G63605 W 140169			
F	74	DODGE M300 Todos	
F	74	M350 Todos	
G63606 D			
R	89-98	MAZDA MPV 4x2 Tracción trasera	
G63607 C 140719			
R	00-05	FORD EXCURSION 4x2 Tracción trasera	
R	91-94	EXPLORER Todos	
R	91-94	MAZDA NAVAJA Todos	
G63608 B 140780			
F	91-94	FORD EXPLORER Todos	
F	91-94	MAZDA NAVAJA Todos	
G63609 B			
F	99-00	CADILLAC ESCALADE Todos	
F	92-94	CHEVROLET BLAZER 4x4 Automóvil Grande	
F	88-00	PICKUP 1 TON, K35 / K3500 Todos	
F	88-00	PICKUP 3/4 TON, K25 / K2500	Todos
F	92-99	SUBURBAN 1/2 TON, K15 / K1500	Todos
F	92-99	SUBURBAN 3/4 TON, K25 / K2500	Todos
F	95-00	TAHOE 4x4 Old Body Style	
F	88-00	GMC PICKUP 1 TON, K35 / K3500	Todos
F	88-00	PICKUP 3/4 TON, K25 / K2500	Todos
F	92-99	SUBURBAN 1/2 TON, K15 / K1500	Todos
F	92-99	SUBURBAN 3/4 TON, K25 / K2500	Todos
F	92-99	YUKON 4x4	
G63610 C 142389			
R	94-97	HONDA PASSPORT Todos	
R	91-97	ISUZU RODEO Todos	
R	98-03	TOYOTA SIENNA Todos	
G63611 C 140524			
F	90-92	DAIHATSU ROCKY Todos	
F	94-02	HONDA PASSPORT Todos	
F	98-00	ISUZU AMIGO Todos	
F	02-04	AXIOM Todos	
F	91-04	RODEO Todos	
G63612 D 141349			
F	87-89	TOYOTA VAN 4x4	
F	88	VAN WAGON Coil (FrontSpringType), Coil (RearSpringType)	
G63614 A 140780			
F	90	FORD BRONCO II Todos	
F	00-05	EXCURSION 4x2 Tracción trasera	
F	90-97	RANGER Todos	
F	94-97	MAZDA B2300 Todos	
F	94-97	B3000 Todos	
F	94-97	B4000 Todos	
G63615 D 142657			
F	94-95	LAND ROVER RANGE ROVER Air (FrontSpringType), Air (RearSpringType)	
F	96-97	LEXUS LX450 Todos	
F	91-97	TOYOTA LAND CRUISER Todos	
G63616 D 140169,142656			
R	96-97	LEXUS LX450 Todos	
R	93-97	TOYOTA LAND CRUISER Todos	
R	91-92	LAND CRUISER FJ80 (Código plataforma del fabricante)	
G63617 D			
F	90-93	FORD PICKUP 1/2 TON, F SUPERDUTY Todos Fab. hasta 2/93	
G63620 C 141405			
R	91-97	TOYOTA PREVIA Todos	
G63621 D 140780			
F	90-97	FORD AEROSTAR AWD	
G63622 A 142617			
F	99-02	FORD ECONOLINE WAGON	
F	99-12	PICKUP 1 TON, F-350 / SUPERDUTY 4x2 Tracción trasera	

Lista numérica

Amort.	POP	No. Alternativo	Montaje Accesorio
Pos.	Año	Aplicación	
G63622	A	-continued	142617
F	11-15	PICKUP 3/4 TON, F-250 / SUPERDUTY 4x2 Tracción trasera Exc. Offroad Package	
F	99-13	PICKUP 3/4 TON, F-250 / SUPERDUTY 4x2 Tracción trasera	
F	08-14	VAN 1/2 TON, ECONOLINE / CLUB WAGON Todos	
F	01-14	VAN 1 TON, ECONOLINE / CLUB WAGON / SUPERDUTY Todos	
F	07	VAN 1 TON, ECONOLINE / CLUB WAGON / SUPERDUTY Todos Exc. Cutaway Chassis	
F	07	VAN 1 TON, ECONOLINE / CLUB WAGON / SUPERDUTY Todos Exc. Paquete de Ambulancia y Manejo	
F	92-05	VAN 1 TON, ECONOLINE / CLUB WAGON / SUPERDUTY Todos Conversión a Motorhome	
F	92-05	VAN 1 TON, ECONOLINE / CLUB WAGON / SUPERDUTY Todos Cutaway Chassis	
F	92-14	VAN 3/4 TON, ECONOLINE / CLUB WAGON / SUPERDUTY Todos	
G63623	C		142617
R	08-14	FORD VAN 1/2 TON, ECONOLINE / CLUB WAGON Todos	
R	10-14	VAN 1 TON, ECONOLINE / CLUB WAGON / SUPERDUTY Todos	
R	04-11	VAN 1 TON, ECONOLINE / CLUB WAGON / SUPERDUTY Todos Exc. Cutaway Chassis	
R	04-11	VAN 1 TON, ECONOLINE / CLUB WAGON / SUPERDUTY Todos Exc. Paquete de Ambulancia y Manejo	
R	92-05	VAN 1 TON, ECONOLINE / CLUB WAGON / SUPERDUTY Todos Conversión a Motorhome	
R	92-05	VAN 1 TON, ECONOLINE / CLUB WAGON / SUPERDUTY Todos Cutaway Chassis	
R	01-03	VAN 1 TON, ECONOLINE / CLUB WAGON / SUPERDUTY Todos	
R	92-14	VAN 3/4 TON, ECONOLINE / CLUB WAGON / SUPERDUTY Todos	
G63624	C		140780
R	92-07	FORD VAN 1/2 TON, ECONOLINE / CLUB WAGON Todos	
G63625	D		140702
F	86-99	CHEVROLET VAN 1 TON, P SERIES Todos Chasis Motorhome c/ Eje de Viga Delantero en I	
F	86-99	GMC VAN 1 TON, P SERIES Todos Chasis Motorhome c/ Eje de Viga Delantero en I	
G63626	D		
R	93-94	JEEP GRAND CHEROKEE Todos	
G63635	D		140524
F	87-93	MAZDA B2600 4x4	
G63638	B		
R	99-00	CADILLAC ESCALADE Todos	
R	92-94	CHEVROLET BLAZER 4x4 Automóvil Grande	
R	92-99	SUBURBAN 1/2 TON, K15 / K1500 Todos	
R	92-99	SUBURBAN 3/4 TON, K25 / K2500 Todos	
R	95-00	TAHOE 4x4 Old Body Style	
R	97-02	VAN 1 TON, G / EXPRESS Todos Exc. PBV 8600 #	
R	96-02	VAN 3/4 TON, G / EXPRESS Todos Exc. PBV 8600 #	
R	92-99	GMC SUBURBAN 1/2 TON, K15 / K1500 Todos	
R	92-99	SUBURBAN 3/4 TON, K25 / K2500 Todos	
R	96-02	VAN 1 TON, G / SAVANNA Todos Exc. PBV 8600 #	
R	96-02	VAN 3/4 TON, G / SAVANNA Todos Exc. PBV 8600 #	
G63639	D		140169
R	87-93	MAZDA B2600 4x4	
G63640	D		
R	89-98	MAZDA MPV 4x4	
G63660	D		
R	93-98	TOYOTA T100 4x4	

Amortiguadores para Camioneta Ultra

Amort.	POP	No. Alternativo	Montaje Accesorio
Pos.	Año	Aplicación	
G63661	B		143000
F	94-97	DODGE MICROBUS	
F	94-01	PICKUP 1/2 TON, RAM 1500 4x2 Tracción trasera	
F	94-02	PICKUP 1 TON, RAM 3500 4x2 Tracción trasera Exc. Eje Delantero Rígido	
F	94-02	PICKUP 3/4 TON, RAM 2500 4x2 Tracción trasera	
G63662	A		
R	03-07	CHEVROLET CHEYENNE	
R	99-06	PICKUP 1/2 TON, SILVERADO 1500 4x2 Tracción trasera Exc. Suspensión Electrónica Ajustable	
R	07	SILVERADO 1500 CLASSIC 4x2 Tracción trasera Exc. Suspensión Electrónica Ajustable	
R	94-01	DODGE PICKUP 1/2 TON, RAM 1500 Todos	
R	94-02	PICKUP 1 TON, RAM 3500 4x2 Tracción trasera Exc. Eje Delantero Rígido	
R	94-03	PICKUP 3/4 TON, RAM 2500 4x4, GAS Exc. PBV 8600 #	
R	94-02	PICKUP 3/4 TON, RAM 2500 4x2 Tracción trasera	
R	95-96	PICKUP 3/4 TON, RAM 2500 4x4, CNG Exc. PBV 8600 #	
R	99-01	RAMCHARGER Todos	
R	99-06	GMC SIERRA 1500 4x2 Tracción trasera Exc. Suspensión Electrónica Ajustable	
R	07	SIERRA 1500 CLASSIC 4x2 Tracción trasera Exc. Suspensión Electrónica Ajustable	
G63671	W		
R	92-96	CHEVROLET VAN 1 TON, G / EXPRESS Cutaway Van	
R	92-96	GMC VAN 1 TON, G / SAVANNA Cutaway Van	
G63673	C		143000
F	94-01	DODGE PICKUP 1/2 TON, RAM 1500 4x4	
F	94-02	PICKUP 3/4 TON, RAM 2500 4x4, GAS Exc. PBV 8600 #	
F	95-96	PICKUP 3/4 TON, RAM 2500 4x4, CNG Exc. PBV 8600 #	
G63674	B		142731
F	94-02	DODGE PICKUP 1 TON, RAM 3500 4x4	
F	94-02	PICKUP 1 TON, RAM 3500 4x2 Tracción trasera Eje Delantero Rígido	
F	94-02	PICKUP 3/4 TON, RAM 2500 4x4, DIESEL PBV 8800	
F	04	RAM 4000	
F	05-08	RAM 4000 Todos	
G63675	A		
R	03-07	CHEVROLET CHEYENNE	
R	99-06	PICKUP 1/2 TON, SILVERADO 1500 4x4 Exc. Suspensión Electrónica Ajustable	
R	05-06	PICKUP 1/2 TON, SILVERADO 1500 HD Todos	
R	01-03	PICKUP 1/2 TON, SILVERADO 1500 HD Todos	
R	77-86	PICKUP 1 TON, K30 Todos	
R	90-91	PICKUP 1 TON, R3500 Todos	
R	89	PICKUP 1 TON, R3500 Cab & Chassis, 4x2 Tracción trasera	
R	89	PICKUP 1 TON, R3500 Crew Cab Pickup, 4x2 Tracción trasera	
R	01-09	PICKUP 1 TON, SILVERADO 3500 Todos	
R	07-10	PICKUP 1 TON, SILVERADO 3500 HD Todos	
R	87-88	PICKUP 1 TON, V30 Todos	
R	89-91	PICKUP 1 TON, V3000 / V3500 Todos	
R	99-08	PICKUP 3/4 TON, SILVERADO 2500 Todos	
R	01-10	PICKUP 3/4 TON, SILVERADO 2500 HD Todos	
R	07	SILVERADO 1500 CLASSIC 4x4 Exc. Suspensión Electrónica Ajustable	
R	02-05	DODGE PICKUP 1/2 TON, RAM 1500 Todos	
R	94-02	PICKUP 1 TON, RAM 3500 4x4	

Lista numérica

Amort.	POP	No. Alternativo	Montaje Accesorio
Pos.	Año	Aplicación	
G63675	A	-continued	
R	94-02	PICKUP 1 TON, RAM 3500 4x2 Tracción trasera Eje Delantero Rígido	
R	94-02	PICKUP 3/4 TON, RAM 2500 4x4, DIESEL PBV 8800	
R	04	RAM 4000	
R	05-08	RAM 4000 Todos	
R	77-86	GMC PICKUP 1 TON, K35 / K3500 Todos	
R	87-91	PICKUP 1 TON, V3000 / V3500 Todos	
R	99-06	SIERRA 1500 4x4 Exc. Suspensión Electrónica Ajustable	
R	07	SIERRA 1500 CLASSIC 4x4 Exc. Suspensión Electrónica Ajustable	
R	05-06	SIERRA 1500 HD Todos	
R	01-03	SIERRA 1500 HD Todos	
R	99-04	SIERRA 2500 Todos	
R	01-10	SIERRA 2500 HD Todos	
R	01-06	SIERRA 3500 Todos	
R	07-10	SIERRA 3500 HD Todos	
G63676	A		
R	95-03	FORD WINDSTAR Coil (RearSpringType)	
G63678	A		142277
F	95-01	FORD EXPLORER Todos Exc. Suspensión de Aire	
F	98	EXPLORER Todos	
F	01-05	EXPLORER SPORT TRAC Todos	
F	12	RANGER Todos	
F	12	RANGER 4x2 Tracción trasera, Torsion (FrontSpringType)	
F	06-11	RANGER 4x2 Tracción trasera, Barra de Torsion (FrontSpringType)	
F	98-11	RANGER 4x4	
F	01-05	RANGER Edge, 4x2 Tracción trasera	
F	03-06	MAZDA B3000 Todos 4x4	
F	98-02	B3000 4x4	
F	98-06	B4000 4x4	
F	97-01	MERCURY MOUNTAINEER Todos Exc. Suspensión Electrónica Ajustable	
G63679	B		140719
R	95-01	FORD EXPLORER Todos Exc. Suspensión de Aire	
R	98	EXPLORER Todos	
R	01-05	EXPLORER SPORT TRAC Todos	
R	97-01	MERCURY MOUNTAINEER Todos Exc. Suspensión Electrónica Ajustable	
G63683	B		
R	95-98	JEEP GRAND CHEROKEE Todos	
G63689	C		
R	01-04	TOYOTA TACOMA S-Runner	
R	04	TACOMA Base, 4x2 Tracción trasera	
R	95-03	TACOMA DLX, 4x2 Tracción trasera	
G63690	A		
R	96-07	CHRYSLER TOWN & COUNTRY Todos Exc. Sistema de Autonivelación NIVOMAT	
R	04-08	VOYAGER / GRAND VOYAGER Todos	
R	00-03	VOYAGER / GRAND VOYAGER Non-ABS Exc. Sistema de Autonivelación NIVOMAT	
R	95-02	VOYAGER / GRAND VOYAGER Todos	
R	96-07	DODGE CARAVAN / GRAND CARAVAN Todos Exc. Sistema de Autonivelación NIVOMAT	
R	05	CARAVAN / GRAND CARAVAN Todos	
R	96-00	PLYMOUTH VOYAGER / GRAND VOYAGER Todos Exc. Sistema de Autonivelación NIVOMAT	
G63692	D		
F	93-97	FORD PICKUP 1/2 TON, F SUPERDUTY Todos Fab. desde 2/93	
F	97	PICKUP, F-450 SUPERDUTY Todos	
G63694	W		141448
R	99	LAND ROVER DISCOVERY SD	
R	99	DISCOVERY SET	
R	94-98	DISCOVERY Todos	

Lista numérica

Amort.	POP	No. Alternativo	Montaje Accesorio
Pos.	Año	Aplicación	
G63694	W	-continued	141448
R	94-95	RANGE ROVER Air (FrontSpringType), Air (RearSpringType)	
G63707	C		141354
F	96-99	ACURA SLX Todos	
F	92-02	ISUZU TROOPER Todos	
F	99-01	VEHICROSS Todos	
G63708	C		140169
R	96-99	ACURA SLX Todos	
R	92-02	ISUZU TROOPER Todos	
R	99-01	VEHICROSS Todos	
G63710	C		140524
R	98-02	HONDA PASSPORT Todos	
R	98-00	ISUZU AMIGO Todos	
R	02-04	AXIOM Todos	
R	98-04	RODEO Todos	
G63712	D		141137
R	98	INFINITI QX4 Todos Fab. hasta 12/98	
R	97	QX4 Todos	
R	96-99	NISSAN PATHFINDER Todos Fab. hasta 12/98	
G63714	A		142731
F	96	FORD EXPEDITION	
F	97-02	EXPEDITION 4x2 Tracción trasera Exc. Nivelación Neumática Delantera	
F	97-04	LOBO PICK UP	
F	97-04	PICKUP 1/2 TON, F-150 4x2 Tracción trasera	
F	97-99	PICKUP 3/4 TON, F-250 / SUPERDUTY 4x2 Tracción trasera Hasta PBV 8500#	
F	98-02	LINCOLN NAVIGATOR 4x2 Tracción trasera	
G63715	B		142700
R	97-03	FORD LOBO PICK UP	
R	97-04	PICKUP 1/2 TON, F-150 4x4 Exc. PBV 7700#	
R	97-99	PICKUP 3/4 TON, F-250 / SUPERDUTY 4x4 Hasta PBV 8500#, Exc. Superduty	
G63716	A		142731
F	97-02	FORD EXPEDITION 4x4 Exc. Nivelación Neumática Delantera	
F	98-03	LOBO PICK UP	
F	04	PICKUP 1/2 TON, F-150 4x4 Exc. PBV 7700#	
F	97-03	PICKUP 1/2 TON, F-150 4x4	
F	97-99	PICKUP 3/4 TON, F-250 / SUPERDUTY 4x4 Hasta PBV 8500#, Exc. Superduty	
G63717	B		
R	97-02	FORD EXPEDITION Todos	
R	98-02	LINCOLN NAVIGATOR 4x2 Tracción trasera	
G63720	W		140800
R	95-02	KIA SPORTAGE Todos	
G63721	D		141665
F	97-06	JEEP WRANGLER TJ (Código plataforma del fabricante)	
G63722	D		
R	97-06	JEEP WRANGLER TJ (Código plataforma del fabricante)	
G63726	D		140921
R	96-02	TOYOTA 4RUNNER Todos	
G63772	A		141665
F	12	FORD RANGER Todos Coil (FrontSpringType)	
F	06-11	RANGER 4x2 Tracción trasera, Coil (FrontSpringType)	
F	01-05	RANGER XL, 4x2 Tracción trasera, Coil (FrontSpringType)	
F	01-05	RANGER XLT, 4x2 Tracción trasera, Coil (FrontSpringType)	
F	02	RANGER EV, 4x2 Tracción trasera	
F	98-00	RANGER XL, 4x2 Tracción trasera	
F	98-00	RANGER XLT, 4x2 Tracción trasera	
F	01-06	MAZDA B2300 4x2 Tracción trasera	
F	98-01	B2500 4x2 Tracción trasera	
F	98-06	B3000 4x2 Tracción trasera	
F	98-06	B4000 4x2 Tracción trasera	

Amortiguadores para Camioneta Ultra

Amort.	POP	No. Alternativo	Montaje Accesorio
Pos.	Año	Aplicación	
G63773	B		
R	12	FORD RANGER Todos Coil (FrontSpringType)	
R	06-11	RANGER 4x2 Tracción trasera, Coil (FrontSpringType)	
R	98-05	RANGER XL, 4x2 Tracción trasera	
R	98-05	RANGER XLT, 4x2 Tracción trasera	
R	05	RANGER STX, 4x2 Tracción trasera	
R	04	RANGER Tremor, 4x2 Tracción trasera	
R	01-06	MAZDA B2300 4x2 Tracción trasera	
R	98-01	B2500 4x2 Tracción trasera	
R	98-06	B3000 4x2 Tracción trasera	
R	98-06	B4000 4x2 Tracción trasera	
G63775	B		
R	12	FORD RANGER Todos	
R	12	RANGER 4x2 Tracción trasera, Torsion (FrontSpringType)	
R	06-11	RANGER 4x2 Tracción trasera, Barra de Torsion (FrontSpringType)	
R	98-11	RANGER 4x4	
R	01-05	RANGER Edge, 4x2 Tracción trasera	
R	03-06	MAZDA B3000 Todos 4x4	
R	98-02	B3000 4x4	
R	98-06	B4000 4x4	
G63776	B		
R	05-07	BUICK TERRAZA 4x2 Tracción delantera Exc. Suspensión con Nivelación Neumática	
R	07-09	CHEVROLET UPLANDER Todos Exc. Suspensión con Nivelación Neumática	
R	05-06	UPLANDER 4x2 Tracción delantera Exc. Suspensión con Nivelación Neumática	
R	97-05	VENTURE Todos	
R	02-04	OLDSMOBILE SILHOUETTE AWD	
R	97-04	SILHOUETTE 4x2 Tracción delantera	
R	07-09	PONTIAC MONTANA 4x2 Tracción delantera	
R	06	MONTANA 4x2 Tracción delantera Exc. Suspensión con Nivelación Neumática	
R	99-05	MONTANA Todos Exc. Suspensión con Nivelación Neumática	
R	97-99	TRANS SPORT Todos	
R	05-07	SATURN RELAY Todos	
G63778	B		142700
R	97-04	FORD LOBO PICK UP	
R	04	PICKUP 1/2 TON, F-150 4x2 Tracción trasera	
R	00-03	PICKUP 1/2 TON, F-150 Harley-Davidson Edition, 4x2 Tracción trasera	
R	99-03	PICKUP 1/2 TON, F-150 Lariat, 4x2 Tracción trasera	
R	99-03	PICKUP 1/2 TON, F-150 XL, 4x2 Tracción trasera	
R	99-03	PICKUP 1/2 TON, F-150 XLT, 4x2 Tracción trasera	
R	00	PICKUP 1/2 TON, F-150 Base, 4x2 Tracción trasera	
R	97-98	PICKUP 1/2 TON, F-150 4x2 Tracción trasera	
R	97-99	PICKUP 3/4 TON, F-250 / SUPERDUTY 4x2 Tracción trasera Hasta PBV 8500#	
G63781	D		141350
R	92-00	MITSUBISHI MONTERO Todos	
G63782	D		141350
F	92-00	MITSUBISHI MONTERO Todos	
F	97-99	MONTERO SPORT Todos	
G63783	A		141665
F	03-07	CHEVROLET CHEYENNE	
F	99-06	PICKUP 1/2 TON, SILVERADO 1500 4x2 Tracción trasera Exc. Suspensión Electrónica Ajustable	
F	99-04	PICKUP 3/4 TON, SILVERADO 2500 4x2 Tracción trasera PBV 8600 Lb.; Exc. Suspensión Quadrasteer	
F	07	SILVERADO 1500 CLASSIC 4x2 Tracción trasera Exc. Suspensión Electrónica Ajustable	
F	99-06	GMC SIERRA 1500 4x2 Tracción trasera Exc. Suspensión Electrónica Ajustable	

Lista numérica

Amort.	POP	No. Alternativo	Montaje Accesorio
Pos.	Año	Aplicación	
G63783	A	-continued	141665
F	07	SIERRA 1500 CLASSIC 4x2 Tracción trasera Exc. Suspensión Electrónica Ajustable	
G63798	D		140455
F	86-95	SUZUKI SAMURAI Todos	
G63799	C		141514
R	92-93	ASUNA SUNRUNNER Todos	
R	05-08	CHEVROLET TRACKER Todos	
R	98-04	TRACKER Non-ABS	
R	89-97	GEO TRACKER Todos	
R	94-97	PONTIAC SUNRUNNER Todos	
R	99-05	SUZUKI GRAND VITARA Todos	
R	89-98	SIDEKICK Todos	
R	99-04	VITARA Todos	
R	96-98	X-90 Todos	
G63803	A		141665
F	02-06	CADILLAC ESCALADE Todos Exc. Control de Manejo Electrónico	
F	03-06	ESCALADE ESV Todos Exc. Control de Manejo Electrónico	
F	03-06	ESCALADE EXT Todos Exc. Control de Manejo Electrónico	
F	02-06	CHEVROLET AVALANCHE 1500 Todos Exc. Control de Manejo Electrónico	
F	03-07	CHEYENNE	
F	99-06	PICKUP 1/2 TON, SILVERADO 1500 4x4 Exc. Suspensión Electrónica Ajustable	
F	07	SILVERADO 1500 CLASSIC 4x4 Exc. Suspensión Electrónica Ajustable	
F	00-06	SONORA Todos Exc. Suspensión Z55	
F	00-06	SUBURBAN 1/2 TON, 1500 Todos Exc. Suspensión Z55 Auto Ride	
F	02-06	TAHOE Todos Exc. Suspensión Z55 Auto Ride	
F	00-01	TAHOE Todos Estilo New Body, Exc. Suspensión Z55	
F	99-06	GMC SIERRA 1500 4x4 Exc. Suspensión Electrónica Ajustable	
F	07	SIERRA 1500 CLASSIC 4x4 Exc. Suspensión Electrónica Ajustable	
F	00-06	YUKON Todos Exc. Suspensión Z55 Auto Ride	
F	00-06	YUKON XL 1/2 TON Todos Exc. Suspensión Z55 Auto Ride	
G63808	B		
R	99-04	FORD PICKUP 1 TON, F-350 / SUPERDUTY 4x2 Tracción trasera	
R	99-04	PICKUP 3/4 TON, F-250 / SUPERDUTY 4x2 Tracción trasera	
G63809	C		
F	00-05	FORD EXCURSION 4x4	
F	99-04	PICKUP 1 TON, F-350 / SUPERDUTY 4x4	
F	99-04	PICKUP 3/4 TON, F-250 / SUPERDUTY 4x4	
F	99-04	PICKUP, F-450 SUPERDUTY Todos	
F	99-04	PICKUP, F-550 SUPERDUTY Todos	
G63810	C		
R	99-04	FORD PICKUP 1 TON, F-350 / SUPERDUTY 4x4	
R	99-04	PICKUP 3/4 TON, F-250 / SUPERDUTY 4x4	
G63811	C		
R	99-04	FORD PICKUP, F-450 SUPERDUTY Todos	
R	99-04	PICKUP, F-550 SUPERDUTY Todos	
G63812	B		
F	01-02	CHEVROLET PICKUP 1 TON, C35/3500 Todos Eje Delantero Rígido HD	
F	91-00	PICKUP 1 TON, C35/3500 Cab & Chassis Eje Delantero Rígido HD	
F	91-00	GMC PICKUP 1 TON, C35/3500 Cab & Chassis Eje Delantero Rígido HD	
G63813	B		142389
F	00-04	NISSAN FRONTIER Crew Cab Pickup, 4x2 Tracción trasera con Desert Runner	
F	98-04	FRONTIER 4x4	
F	98-99	FRONTIER 4x2 Tracción trasera Crew Cab con Desert Runner	

Lista numérica

Amort.	POP	No. Alternativo	Montaje Accesorio
Pos.	Año	Aplicación	
G63813	B	-continued	142389
F	00-04	XTERRA Todos	
G63815	C		142389
R	00-06	TOYOTA TUNDRA Todos	
G63817	A		141665
F	02-06	CHEVROLET AVALANCHE 2500 Todos Exc. Control de Manejo Electrónico	
F	05-06	PICKUP 1/2 TON, SILVERADO 1500 HD Todos	
F	01-03	PICKUP 1/2 TON, SILVERADO 1500 HD Todos	
F	01-09	PICKUP 1 TON, SILVERADO 3500 Todos	
F	07-10	PICKUP 1 TON, SILVERADO 3500 HD Todos	
F	05-08	PICKUP 3/4 TON, SILVERADO 2500 Todos	
F	99-04	PICKUP 3/4 TON, SILVERADO 2500 4x4	
F	01-10	PICKUP 3/4 TON, SILVERADO 2500 HD Todos PBV 9200	
F	00-11	SUBURBAN 3/4 TON, 2500 Todos Exc. Suspensión Auto Ride Z55 y Quadrasteer	
F	05-06	GMC SIERRA 1500 HD Todos	
F	01-03	SIERRA 1500 HD Todos	
F	99-04	SIERRA 2500 4x4	
F	01-10	SIERRA 2500 HD Todos	
F	01-06	SIERRA 3500 Todos	
F	07-10	SIERRA 3500 HD Barra de Torsion (FrontSpringType)	
F	00-06	YUKON XL 3/4 TON Todos Exc. Sistema de Autonivelación NIVOMAT	
F	03-07	HUMMER H2 Todos	
G63818	B		
F	90-05	CHEVROLET ASTRO AWD	
F	88-99	PICKUP 1/2 TON, K15 / K1500 Todos	
F	88-99	GMC PICKUP 1/2 TON, K15 / K1500 Todos	
F	90-05	SAFARI AWD	
G63828	W		142976
R	98-06	LEXUS LX470 Barra de Torsion (FrontSpringType)	
R	98-07	TOYOTA LAND CRUISER Todos	
G63829	B		
R	99-04	JEEP GRAND CHEROKEE Todos	
G63832	D		142976
F	98-06	LEXUS LX470 Barra de Torsion (FrontSpringType)	
F	98-07	TOYOTA LAND CRUISER Todos	
G63837	D		
R	00-05	FORD EXCURSION 4x4	
G63841	C		
F	72-01	VOLKSWAGEN COMBI	
F	52-77	COMBI CARAVEL	
F	72-01	COMBI PANEL	
G63842	C		
R	04-07	BUICK RAINIER Coil (FrontSpringType)	
R	03-06	CHEVROLET SSR Todos	
R	02-09	TRAILBLAZER Coil (RearSpringType)	
R	02-09	GMC ENVOY Coil (RearSpringType)	
R	03-08	ISUZU ASCENDER Coil (RearSpringType)	
R	02-04	OLDSMOBILE BRAVADA Coil (RearSpringType)	
R	05-09	SAAB 9-7X Todos	
G63844	B		
R	07-11	DODGE NITRO Todos	
R	02-12	JEEP LIBERTY Todos	
G63845	C		
R	99-03	INFINITI QX4 Todos Fab. desde 12/98	
R	02-04	NISSAN PATHFINDER Todos	
R	99-01	PATHFINDER Todos Fab. desde 12/98	
G63847	B		141353,142592
F	99-04	JEEP GRAND CHEROKEE Todos Exc. Suspensión Up Country	

Amortiguadores para Camioneta Ultra

Amort.	POP	No. Alternativo	Montaje Accesorio
Pos.	Año	Aplicación	
G63848	C		142731
F	02-05	DODGE PICKUP 1/2 TON, RAM 1500 4x4	
G63860	C		140455
R	96-05	TOYOTA RAV4 Todos	
G63862	B		141041
R	01-07	FORD ESCAPE Todos	
R	01-06	MAZDA TRIBUTE Todos	
R	05-07	MERCURY MARINER Todos	
G63864	D		
R	00-06	MAZDA MPV Todos	
G63865	S		
R	01-07	TOYOTA SEQUOIA Todos	
G63866	B		
R	02-13	CADILLAC ESCALADE Todos	
R	07-11	CHEVROLET AVALANCHE 1500 Todos Exc. Suspensión Z55 o ZW7	
R	02-06	AVALANCHE 1500 Todos Exc. Control de Manejo Electrónico	
R	02-06	AVALANCHE 2500 Todos Exc. Control de Manejo Electrónico	
R	00-06	SONORA Todos Exc. Suspensión Z55	
R	07-11	SUBURBAN 1/2 TON, 1500 Todos Exc. Suspensión Z55 o ZW7	
R	00-06	SUBURBAN 1/2 TON, 1500 Todos Exc. Suspensión Z55 Auto Ride	
R	00-11	SUBURBAN 3/4 TON, 2500 Todos Exc. Suspensión Auto Ride Z55 y Quadrasteer	
R	02-11	TAHOE Todos Exc. Suspensión Z55 o ZW7	
R	00-01	TAHOE Todos Estilo New Body, Exc. Suspensión Z55	
R	07-11	GMC YUKON Todos Exc. Suspensión Z55 o ZW7	
R	00-06	YUKON Todos Exc. Suspensión Z55 Auto Ride	
R	07-11	YUKON XL 1/2 TON Todos Exc. Suspensión Z55 o ZW7	
R	00-06	YUKON XL 1/2 TON Todos Exc. Suspensión Z55 Auto Ride	
R	00-06	YUKON XL 3/4 TON Todos Exc. Sistema de Autonivelación NIVOMAT	
G63867	B		
R	04-08	FORD LOBO PICK UP	
R	09-10	PICKUP 1/2 TON, F-150 4x2 Tracción trasera	
R	04-08	PICKUP 1/2 TON, F-150 4x4	
R	06-08	LINCOLN MARK LT 4x4	
G63868	X		
R	02-07	BUICK RENDEZVOUS Todos Exc. Sistema de Autonivelación NIVOMAT	
R	01-05	PONTIAC AZTEK AWD	
G63869	D		
R	01-05	PONTIAC AZTEK 4x2 Tracción delantera	
G63870	B		
R	04-08	FORD LOBO PICK UP	
R	05-08	PICKUP 1/2 TON, F-150 4x2 Tracción trasera	
R	04	PICKUP 1/2 TON, F-150 Lariat, 4x2 Tracción trasera	
R	04	PICKUP 1/2 TON, F-150 STX, 4x2 Tracción trasera	
R	04	PICKUP 1/2 TON, F-150 XL, 4x2 Tracción trasera	
R	04	PICKUP 1/2 TON, F-150 XLT, 4x2 Tracción trasera	
R	06-08	LINCOLN MARK LT 4x2 Tracción trasera	
G63872	C		
R	07-12	CHEVROLET CAPTIVA	
R	02-10	SATURN VUE Todos	
G63873	D		
R	04-07	FORD FREESTAR Todos	
R	04-07	MERCURY MONTEREY Mini Passenger Van	
G63875	C		
R	04-08	CHEVROLET TORNADO Todos	
R	05-07	INFINITI QX56 Todos	
R	05-15	NISSAN ARMADA Todos Exc. Sistema de Autonivelación	

Lista numérica

Amort.	POP	No. Alternativo	Montaje Accesorio
Pos.	Año	Aplicación	
G63877	C		
R	99-04	HONDA ODYSSEY Todos	
G63878	C		
R	04-15	NISSAN TITAN 4x4	
G63879	C		
R	04-12	CHEVROLET COLORADO Barra de Torsion (FrontSpringType)	
R	04-11	GMC CANYON Barra de Torsion (FrontSpringType)	
R	07	ISUZU I-370 Todos	
G63880	W		
R	01-03	KIA RIO Todos	
G63881	D		140126
F	87-96	DODGE DAKOTA 4x4	
G63882	C		
R	04-12	CHEVROLET COLORADO 4x2 Tracción trasera Suspensión Standard D; Exc. Paquete Z71 Offroad	
R	04-12	GMC CANYON 4x2 Tracción trasera D Standard Suspensión; Exc. Z71 Offroad Package	
R	06	ISUZU I-280 Todos	
R	07-08	I-290 Todos	
R	08	I-370 Todos	
G63883	C		
R	04-15	NISSAN TITAN 4x2 Tracción trasera	
G63884	C		143312
F	04-12	CHEVROLET COLORADO Barra de Torsion (FrontSpringType)	
F	04-09	GMC CANYON Barra de Torsion (FrontSpringType)	
F	06	ISUZU I-350 Barra de Torsion (FrontSpringType)	
F	07	I-370 Barra de Torsion (FrontSpringType)	
G63885	D		142280
R	12-16	TOYOTA 4RUNNER Todos	
R	10-11	4RUNNER Trail	
R	03-11	4RUNNER Limited	
R	03-11	4RUNNER SR5	
G63886	C		142731
F	05-12	FORD PICKUP 1 TON, F-350 / SUPERDUTY 4x4	
F	05-13	PICKUP 3/4 TON, F-250 / SUPERDUTY 4x4	
G63887	W		
R	05-07	FORD PICKUP 1 TON, F-350 / SUPERDUTY Crew Cab Pickup, 4x4 Doble Rodada Trasera	
R	05-07	PICKUP 1 TON, F-350 / SUPERDUTY Extended Cab Pickup, 4x4 Doble Rodada Trasera	
R	05-07	PICKUP 1 TON, F-350 / SUPERDUTY Standard Cab Pickup, 4x4 Doble Rodada Trasera	
G63888	D		
R	05-12	FORD PICKUP 1 TON, F-350 / SUPERDUTY Crew Cab Pickup, 4x4 Rodada Trasera Sencilla	
R	05-12	PICKUP 1 TON, F-350 / SUPERDUTY Extended Cab Pickup, 4x4 Rodada Trasera Sencilla	
R	05-12	PICKUP 1 TON, F-350 / SUPERDUTY Standard Cab Pickup, 4x4 Rodada Trasera Sencilla	
R	05-15	PICKUP 3/4 TON, F-250 / SUPERDUTY 4x4	
G63889	C		141041
R	05-13	TOYOTA TACOMA Base, 4x2 Tracción trasera	
G63890	C		
R	05-10	DODGE DAKOTA 4x2 Tracción trasera	
R	06-09	MITSUBISHI RAIDER 4x2 Tracción trasera	
G63891	C		
R	05-10	DODGE DAKOTA 4x4	
R	06-09	MITSUBISHI RAIDER 4x4	
G63892	C		
R	07-09	CHRYSLER ASPEN Todos	
R	04-09	DODGE DURANGO Todos	

Lista numérica

Amort.	POP	No. Alternativo	Montaje Accesorio
Pos.	Año	Aplicación	
G63893	D		143276
F	03-11	CHEVROLET VAN 1/2 TON, G / EXPRESS Barra de Torsión (FrontSpringType)	
F	03-12	VAN 1 TON, G / EXPRESS Todos Barra de Torsión (Suspensión de Resorte Delantera)	
F	06-12	VAN 3/4 TON, G / EXPRESS Todos Barra de Torsión (Suspensión de Resorte Delantera)	
F	03-05	VAN 3/4 TON, G / EXPRESS Barra de Torsión (FrontSpringType)	
F	03-11	GMC VAN 1/2 TON, G / SAVANNA Barra de Torsión (FrontSpringType)	
F	03-12	VAN 1 TON, G / SAVANNA Todos Barra de Torsión (Suspensión de Resorte Delantera)	
F	04-12	VAN 3/4 TON, G / SAVANNA Todos Barra de Torsión (Suspensión de Resorte Delantera)	
F	03	VAN 3/4 TON, G / SAVANNA Barra de Torsión (FrontSpringType)	
G63894	C		143276
F	03-11	CHEVROLET VAN 1/2 TON, G / EXPRESS 4x2 Tracción trasera, Coil (FrontSpringType)	
F	03-11	GMC VAN 1/2 TON, G / SAVANNA 4x2 Tracción trasera, Coil (FrontSpringType)	
G63895	D		143276
F	03-16	CHEVROLET VAN 1 TON, G / EXPRESS Coil (FrontSpringType)	
F	03-16	VAN 3/4 TON, G / EXPRESS Coil (FrontSpringType)	
F	03-16	GMC VAN 1 TON, G / SAVANNA Coil (FrontSpringType)	
F	03-16	VAN 3/4 TON, G / SAVANNA Coil (FrontSpringType)	
G63896	C		
R	92-99	CHEVROLET SUBURBAN 1/2 TON, C15 / C1500 Todos	
R	92-99	SUBURBAN 3/4 TON, C25 / C2500 Todos	
R	95-00	TAHOE 4x2 Tracción trasera Old Body Style	
R	96-11	VAN 1/2 TON, G / EXPRESS Todos	
R	93-99	GMC SUBURBAN 1/2 TON, C15 / C1500 Todos	
R	92	SUBURBAN 1/2 TON, C15 / C1500 Todos Old Body Style	
R	92-99	SUBURBAN 3/4 TON, C25 / C2500 Todos	
R	96-11	VAN 1/2 TON, G / SAVANNA Todos	
R	00	YUKON Denali	
R	92-99	YUKON Todos	
G63897	C		
R	10-15	CHEVROLET EXPRESS 4500 Todos	
R	13-16	VAN 1 TON, G / EXPRESS Todos	
R	03-12	VAN 1 TON, G / EXPRESS Todos Rodada Trasera Sencilla	
R	03-12	VAN 1 TON, G / EXPRESS Todos Single Rear Wheels	
R	03-16	VAN 3/4 TON, G / EXPRESS Todos	
R	10-15	GMC SAVANA 4500 Todos	
R	13-16	VAN 1 TON, G / SAVANNA Todos	
R	03-12	VAN 1 TON, G / SAVANNA Todos Rodada Trasera Sencilla	
R	03-12	VAN 1 TON, G / SAVANNA Todos Single Rear Wheels	
R	03-16	VAN 3/4 TON, G / SAVANNA Todos	
G63898	D		
R	03-06	CHEVROLET VAN 1 TON, G / EXPRESS Todos Doble Rodada Trasera	
R	03-06	GMC VAN 1 TON, G / SAVANNA Todos Doble Rodada Trasera	
G63900	W		140673
F	87-89	TOYOTA VAN 4x2 Tracción trasera	
F	84-86	VAN Todos	
F	88	VAN WAGON Leaf (FrontSpringType), Leaf (RearSpringType)	
G63902	A		140857
F	81-82	CHEVROLET LUV PICKUP 4x2 Tracción trasera	
F	81-95	ISUZU PICKUP 4x2 Tracción trasera	
F	69-72	NISSAN 521 PICKUP Todos	
F	72-79	620 PICKUP Todos	

Amortiguadores para Camioneta Ultra

Amort.	POP	No. Alternativo	Montaje Accesorio
Pos.	Año	Aplicación	
G63902	A	-continued	140857
F	80-86	720 PICKUP Todos	
F	65-12	PICKUP	
G63903	A		141376
F	85-95	TOYOTA PICKUP 4x2 Tracción trasera Exc. 1 Ton	
F	84	PICKUP 4x2 Tracción trasera	
F	93-98	T100 4x2 Tracción trasera	
G63904	C		141356
F	87-90	NISSAN PATHFINDER Todos Exc. Suspensión Electrónica Ajustable	
F	87-95	NISSAN PATHFINDER Todos Exc. Suspensión Electrónica Ajustable	
G63905	B		140126
F	97-04	DODGE DAKOTA 4x4	
F	98-03	DURANGO 4x4	
G63906	D		
F	87-91	CHEVROLET BLAZER 4x4 Automóvil Grande; Suspensión Quad Amortiguador Largo; Exc. Kit de Levantamiento	
F	81-86	BLAZER 4x4 Suspensión Quad Amortiguador Largo; Exc. Kit de Levantamiento	
F	81-86	PICKUP 1/2 TON, K10 Todos Suspensión Quad Amortiguador Largo; Exc. Kit de Levantamiento	
F	87	PICKUP 1/2 TON, V10 Todos Suspensión Quad Amortiguador Largo; Exc. Kit de Levantamiento	
F	81-86	PICKUP 3/4 TON, K20 Todos Suspensión Quad Amortiguador Largo; Exc. Kit de Levantamiento	
F	87	PICKUP 3/4 TON, V20 Todos Suspensión Quad Amortiguador Largo; Exc. Kit de Levantamiento	
F	81-86	SUBURBAN 1/2 TON, K10 Todos Suspensión Quad Amortiguador Largo; Exc. Kit de Levantamiento	
F	89-91	SUBURBAN 1/2 TON, V1500 Todos Suspensión Quad Amortiguador Largo; Exc. Kit de Levantamiento	
F	81-86	SUBURBAN 3/4 TON, K20 Todos Suspensión Quad Amortiguador Largo; Exc. Kit de Levantamiento	
F	87-88	SUBURBAN 3/4 TON, V20 Todos Suspensión Quad Amortiguador Largo; Exc. Kit de Levantamiento	
F	89-91	SUBURBAN 3/4 TON, V2500 Todos Suspensión Quad Amortiguador Largo; Exc. Kit de Levantamiento	
F	73-91	GMC JIMMY 4x4 Suspensión Quad Amortiguador Largo; Exc. Kit de Levantamiento	
F	81-86	PICKUP 1/2 TON, K15 / K1500 Todos Suspensión Quad Amortiguador Largo; Exc. Kit de Levantamiento	
F	87	PICKUP 1/2 TON, V1500 Todos Suspensión Quad Amortiguador Largo; Exc. Kit de Levantamiento	
F	81-86	PICKUP 3/4 TON, K25 / K2500 Todos Suspensión Quad Amortiguador Largo; Exc. Kit de Levantamiento	
F	87	PICKUP 3/4 TON, V2500 Todos Suspensión Quad Amortiguador Largo; Exc. Kit de Levantamiento	
F	81-86	SUBURBAN 1/2 TON, K15 / K1500 Todos Suspensión Quad Amortiguador Largo; Exc. Kit de Levantamiento	
F	87-91	SUBURBAN 1/2 TON, V1500 Todos Suspensión Quad Amortiguador Largo; Exc. Kit de Levantamiento	
F	81-86	SUBURBAN 3/4 TON, K25 / K2500 Todos Suspensión Quad Amortiguador Largo; Exc. Kit de Levantamiento	
F	87-91	SUBURBAN 3/4 TON, V2500 Todos Suspensión Quad Amortiguador Largo; Exc. Kit de Levantamiento	
G63907	A		
R	75-80	CHEVROLET LUV PICKUP Todos	
R	72-74	LUV PICKUP Todos	
R	79-82	DODGE D50 4x2 Tracción trasera	
R	87-93	PICKUP, RAM 50 4x2 Tracción trasera	
R	83-86	PICKUP, RAM 50 Todos	
R	86-87	MAZDA B2000 4x2 Tracción trasera	
R	87-93	B2200 4x2 Tracción trasera	
R	87-93	B2600 4x2 Tracción trasera	

Lista numérica

Amort.	POP	No. Alternativo	Montaje Accesorio
Pos.	Año	Aplicación	
G63907	A	-continued	
R	95-96	NISSAN MIGHTY MAX Todos	
R	83-94	MIGHTY MAX 4x2 Tracción trasera	
R	87-90	VAN Todos	
R	98-04	NISSAN FRONTIER 4x2 Tracción trasera Exc. Desert Runner	
R	87-93	ICHIVAN	
R	65-12	PICKUP	
R	10-13	URVAN Todos	
R	00-08	URVAN Todos	
R	79-82	PLYMOUTH ARROW PICKUP Todos	
R	85-95	TOYOTA PICKUP 4x2 Tracción trasera Exc. 1 Ton	
R	84	PICKUP 4x2 Tracción trasera	
R	70-83	PICKUP 4x2 Tracción trasera Mojave	
R	84-88	VAN Leaf (RearSpringType)	
R	88	VAN WAGON Leaf (FrontSpringType), Leaf (RearSpringType)	
G63908	D		
F	87-91	CHEVROLET BLAZER 4x4 Automóvil Grande; Suspensión Quad Amortiguador Corto; Exc. Kit de Levantamiento	
F	81-86	BLAZER 4x4 Suspensión Quad Amortiguador Corto; Exc. Kit de Levantamiento	
F	81-86	PICKUP 1/2 TON, K10 Todos Suspensión Quad Amortiguador Corto; Exc. Kit de Levantamiento	
F	87	PICKUP 1/2 TON, V10 Todos Suspensión Quad Amortiguador Corto; Exc. Kit de Levantamiento	
F	81-86	PICKUP 3/4 TON, K20 Todos Suspensión Quad Amortiguador Corto; Exc. Kit de Levantamiento	
F	87	PICKUP 3/4 TON, V20 Todos Suspensión Quad Amortiguador Corto; Exc. Kit de Levantamiento	
F	81-86	SUBURBAN 1/2 TON, K10 Todos Suspensión Quad Amortiguador Corto; Exc. Kit de Levantamiento	
F	89-91	SUBURBAN 1/2 TON, V1500 Todos Suspensión Quad Amortiguador Corto; Exc. Kit de Levantamiento	
F	81-86	SUBURBAN 3/4 TON, K20 Todos Suspensión Quad Amortiguador Corto; Exc. Kit de Levantamiento	
F	87-88	SUBURBAN 3/4 TON, V20 Todos Suspensión Quad Amortiguador Corto; Exc. Kit de Levantamiento	
F	89-91	SUBURBAN 3/4 TON, V2500 Todos Suspensión Quad Amortiguador Corto; Exc. Kit de Levantamiento	
F	73-91	GMC JIMMY 4x4 Suspensión Quad Amortiguador Corto; Exc. Kit de Levantamiento	
F	81-86	PICKUP 1/2 TON, K15 / K1500 Todos Suspensión Quad Amortiguador Corto; Exc. Kit de Levantamiento	
F	87	PICKUP 1/2 TON, V1500 Todos Suspensión Quad Amortiguador Corto; Exc. Kit de Levantamiento	
F	81-86	PICKUP 3/4 TON, K25 / K2500 Todos Suspensión Quad Amortiguador Corto; Exc. Kit de Levantamiento	
F	87	PICKUP 3/4 TON, V2500 Todos Suspensión Quad Amortiguador Corto; Exc. Kit de Levantamiento	
F	81-86	SUBURBAN 1/2 TON, K15 / K1500 Todos Suspensión Quad Amortiguador Corto; Exc. Kit de Levantamiento	
F	87-91	SUBURBAN 1/2 TON, V1500 Todos Suspensión Quad Amortiguador Corto; Exc. Kit de Levantamiento	
F	81-86	SUBURBAN 3/4 TON, K25 / K2500 Todos Suspensión Quad Amortiguador Corto; Exc. Kit de Levantamiento	
F	87-91	SUBURBAN 3/4 TON, V2500 Todos Suspensión Quad Amortiguador Corto; Exc. Kit de Levantamiento	
G63909	B		141368
F	81-82	CHEVROLET LUV PICKUP 4x4	
F	75-80	LUV PICKUP Todos	
F	72-74	LUV PICKUP Todos	
F	02-07	DODGE H100	
F	89-94	ISUZU AMIGO Todos	

Lista numérica

Amort.	POP	No. Alternativo	Montaje Accesorio
Pos.	Año	Aplicación	
G63909	B	-continued	141368
F	81-95	PICKUP 4x4	
F	84-86	TROOPER Todos	
F	98-04	NISSAN FRONTIER 4x2 Tracción trasera Exc. Desert Runner	
F	65-94	PICKUP	
G63914	C		141277
R	90-96	CHEVROLET LUMINA APV Todos	
R	90-96	OLDSMOBILE SILHOUETTE Todos	
R	90-96	PONTIAC TRANS SPORT Todos	
G63915	B		140126
F	87-04	DODGE DAKOTA 4x2 Tracción trasera	
F	99-03	DURANGO 4x2 Tracción trasera	
G63918	D		
R	03-06	DODGE SPRINTER 2500 Todos Exc. Doble Rodada Trasera	
R	03-06	SPRINTER 3500 Todos Exc. Doble Rodada Trasera	
R	04-06	MERCEDES-BENZ SPRINTER Todos Exc. Doble Rodada Trasera	
G63919	D		
R	03-06	DODGE SPRINTER 3500 Todos Doble Rodada Trasera	
R	04-06	MERCEDES-BENZ SPRINTER Todos Doble Rodada Trasera	
G63928	D		
R	89-94	ISUZU AMIGO Todos	
R	81-95	PICKUP 4x4	
R	84-86	TROOPER Todos	
R	68-75	JEEP CJ7	
G63929	C		140780
F	92-07	FORD VAN 1/2 TON, ECONOLINE / CLUB WAGON Todos	
G63937	C		140673
F	01-04	TOYOTA TACOMA S-Runner	
F	04	TACOMA Base, 4x2 Tracción trasera	
F	95-03	TACOMA DLX, 4x2 Tracción trasera	
G63949	C		
R	02-07	DODGE H100	
R	86-95	SUZUKI SAMURAI Todos	
G63950	D		140455
F	79-82	DODGE D50 4x2 Tracción trasera	
F	83-93	PICKUP, RAM 50 4x2 Tracción trasera	
F	83-96	MITSUBISHI MIGHTY MAX 4x2 Tracción trasera	
F	79-82	PLYMOUTH ARROW PICKUP Todos	
G63958	B		143276
F	06-08	DODGE PICKUP 1/2 TON, RAM 1500 Crew Cab Pickup, 4x2 Tracción trasera	
F	06-08	PICKUP 1/2 TON, RAM 1500 Standard Cab Pickup, 4x2 Tracción trasera	
F	02-05	PICKUP 1/2 TON, RAM 1500 4x2 Tracción trasera	
G63959	A		
R	07-15	CHEVROLET CHEYENNE	
R	08-15	PICKUP 1/2 TON, SILVERADO 1500 Todos Exc. Suspensión Electrónica Ajustable	
R	14	PICKUP 1/2 TON, SILVERADO 1500 Todos Exc. Modelo Classic y Suspensión Electrónica Ajustable	
R	07	PICKUP 1/2 TON, SILVERADO 1500 Base Exc. Suspensión Electrónica Ajustable	
R	07	PICKUP 1/2 TON, SILVERADO 1500 LT Exc. Suspensión Electrónica Ajustable	
R	07	PICKUP 1/2 TON, SILVERADO 1500 LTZ Exc. Suspensión Electrónica Ajustable	
R	07	PICKUP 1/2 TON, SILVERADO 1500 WT Exc. Suspensión Electrónica Ajustable	
R	08-15	GMC SIERRA 1500 Todos Exc. Suspensión Electrónica Ajustable	
R	14	SIERRA 1500 Todos Exc. Modelo Classic y Suspensión Electrónica Ajustable	
R	07	SIERRA 1500 SLE Exc. Suspensión Electrónica Ajustable	

Amortiguadores para Camioneta Ultra

Amort.	POP	No. Alternativo	Montaje Accesorio
Pos.	Año	Aplicación	
G63959	A	-continued	
R	07	SIERRA 1500 SLT Exc. Suspensión Electrónica Ajustable	
R	07	SIERRA 1500 WT Exc. Suspensión Electrónica Ajustable	
G63961	D		
R	06-08	DODGE PICKUP 1/2 TON, RAM 1500 4x4 Exc. Mega Cab	
G63962	C		
R	06-08	DODGE PICKUP 1/2 TON, RAM 1500 4x2 Tracción trasera Exc. Mega Cab	
G63963	C		
R	05-06	FORD PICKUP, F-450 SUPERDUTY Todos	
R	05-06	PICKUP, F-550 SUPERDUTY Todos	
G63964	W		
R	05-06	FORD PICKUP 1 TON, F-350 / SUPERDUTY Cab & Chassis, 4x4	
G63965	D		
R	02-07	DODGE H-100 DIESEL	
R	06-10	HUMMER H3 Todos	
G63966	D		
R	13-15	JEEP WRANGLER Todos	
R	07-12	WRANGLER Todos Exc. Ruedas de 17"	
G63967	C		
R	07-15	JEEP WRANGLER Todos Ruedas de 17"	
G63969	C		143146
F	05-08	FORD PICKUP, F-450 SUPERDUTY Todos	
F	05-07	PICKUP, F-550 SUPERDUTY Todos	
G63970	C		
R	03-10	DODGE PICKUP 1 TON, RAM 3500 Standard Cab Pickup, 4x2 Tracción trasera	
R	03-10	PICKUP 3/4 TON, RAM 2500 Standard Cab Pickup, 4x2 Tracción trasera	
R	11-14	RAM 2500 (SEE DODGE RAM 2500) Standard Cab Pickup, 4x2 Tracción trasera	
R	11-14	3500 (SEE DODGE RAM 3500) Standard Cab Pickup, 4x2 Tracción trasera	
G63971	D		
R	03-07	DODGE PICKUP 1 TON, RAM 3500 Crew Cab Pickup, 4x2 Tracción trasera	
R	03-06	PICKUP 3/4 TON, RAM 2500 Crew Cab Pickup, 4x2 Tracción trasera	
G64000	D		
R	03-06	HUMMER H2 Todos	
G64001	C		143276
F	02-07	DODGE H-100 DIESEL	
F	06-10	HUMMER H3 Todos	
G64002	D		
R	98-02	LINCOLN NAVIGATOR 4x4, Air (RearSpringType)	
G64003	C		
R	01-06	ACURA MDX Todos	
R	03-08	HONDA PILOT Todos	
G64004	D		141041
R	05-12	TOYOTA TACOMA X-Runner Izquierdo	
G64005	D		141041
R	05-12	TOYOTA TACOMA X-Runner Derecho	
G64006	C		141041
R	05-12	TOYOTA TACOMA 4x4	
G64007	C		141041
R	05-12	TOYOTA TACOMA Pre Runner	
G64008	C		142973
F	07-12	JEEP WRANGLER Todos	
G64009	D		142731
F	10-15	RAM 2500 (SEE DODGE RAM 2500) 4x4	

Lista numérica

Amort.	POP	No. Alternativo	Montaje Accesorio
Pos.	Año	Aplicación	
G64009	D	-continued	142731
F	11-15	3500 (SEE DODGE RAM 3500) 4x4	
G64010	C		
R	05-12	FORD PICKUP 1 TON, F-350 / SUPERDUTY 4x2 Tracción trasera	
R	05-15	PICKUP 3/4 TON, F-250 / SUPERDUTY 4x2 Tracción trasera	
G64011	C		142731
F	05-08	DODGE PICKUP 3/4 TON, RAM 2500 4x4	
F	10-15	RAM 1500 (SEE DODGE RAM 1500) 4x4	
G64012	C		
R	06-10	JEEP COMMANDER Todos	
R	05-10	GRAND CHEROKEE Todos	
G64013	C		
R	03-10	DODGE PICKUP 3/4 TON, RAM 2500 4x4 PBV 8800	
R	11-12	RAM 2500	
R	13	RAM 2500 (SEE DODGE RAM 2500) 4x4	
R	11-12	2500 (SEE DODGE RAM 2500) 4x4 PBV 8800	
G64014	D		
R	06-09	CHEVROLET TRAILBLAZER Air (RearSpringType)	
R	02-05	TRAILBLAZER Todos Suspensión de Resorte de Aire Trasera	
R	03-06	GMC ENVOY Air (RearSpringType)	
G64015	B		
R	05-13	CHEVROLET EQUINOX Todos	
R	10-13	GMC TERRAIN Todos	
R	06-09	PONTIAC TORRENT Todos	
R	07-09	SUZUKI XL-7 Todos	
G64016	B		
F	07-09	CHRYSLER ASPEN Todos	
F	04-09	DODGE DURANGO Todos	
G64026	B		
R	06-12	TOYOTA RAV4 Todos	
G64027	D		
F	00-07	MITSUBISHI MONTERO SPORT Todos	
G64028	D		
R	00-07	MITSUBISHI MONTERO SPORT Todos	
G64029	W		142731
R	07-12	TOYOTA FJ CRUISER 4x2 Tracción trasera	
G64030	D		142731
R	11-12	TOYOTA FJ CRUISER 4x4	
R	07-09	FJ CRUISER 4x4	
G64031	C		
R	14-16	NISSAN FRONTIER Todos	
R	09-13	FRONTIER Todos Exc. Nismo Off-Road	
R	05-08	FRONTIER LE	
R	05-08	FRONTIER SE	
R	05-08	FRONTIER XE	
G64032	N		
R	03-06	KIA SORENTO Todos	
G64033	C		
R	13	NISSAN PATHFINDER Todos	
R	12	PATHFINDER Todos Fab. hasta 12/12	
R	05-11	PATHFINDER Todos	
G64036	D		141716
R	01-04	MITSUBISHI MONTERO Todos Exc. Sport	
G64037	C		
R	07-10	FORD EDGE Todos	
R	07-09	LINCOLN MKX Todos	
G64038	C		143340
R	07-13	TOYOTA TUNDRA Todos	
G64040	C		
R	08-16	BUICK ENCLAVE Todos	
R	09-16	CHEVROLET TRAVERSE Todos	
R	07-16	GMC ACADIA Todos	
R	07-10	SATURN OUTLOOK Todos	

Lista numérica

Amortiguadores para Camioneta Ultra, Amortiguadores Ultra

Lista numérica

Amort.	POP	No. Alternativo	Montaje Accesorio
Pos.	Año	Aplicación	
G64042	C		
R	08-16	CHRYSLER TOWN & COUNTRY Todos Exc. Suspensión Autonivelable	
R	08-16	DODGE CARAVAN / GRAND CARAVAN Todos Exc. Suspensión Autonivelable	
R	11	VOLKSWAGEN ROUTAN Todos	
R	09-10	ROUTAN Todos Exc. Suspensión Autonivelable	
G64043	B		
F	09-10	DODGE PICKUP 1/2 TON, RAM 1500 4x2 Tracción trasera	
F	11-14	RAM 1500	
F	11-14	RAM 1500 (SEE DODGE RAM 1500) 4x2 Tracción trasera	
F	10-15	2500 (SEE DODGE RAM 2500) Standard Cab Pickup, 4x2 Tracción trasera	
F	11-15	3500 (SEE DODGE RAM 3500) Standard Cab Pickup, 4x2 Tracción trasera	
G64044	B		
R	09-10	DODGE PICKUP 1/2 TON, RAM 1500 Todos	
R	11-14	RAM 1500	
R	10-15	RAM 1500 (SEE DODGE RAM 1500) 4x4	
R	11-14	1500 (SEE DODGE RAM 1500) Todos	
G64046	D		
R	00-06	BMW X5 Todos	
G64047	B		
R	08-12	FORD ESCAPE Todos	
R	08-11	MAZDA TRIBUTE Todos	
R	08-11	MERCURY MARINER Todos	
G64048	D		
R	07-09	HYUNDAI SANTA FE Todos	
R	07-12	VERACRUZ Todos	
G64049	D		
F	00-03	MERCEDES-BENZ ML55 AMG Todos	
F	98-03	ML320 Todos	
F	03-05	ML350 Todos	
F	99-01	ML430 Todos	
F	02-05	ML500 Todos	
G64050	B		
R	08-16	NISSAN ROGUE Todos	
R	10-12	X-TRAIL Todos	
R	08	X-TRAIL Todos	
R	09-14	RENAULT KOLEOS Todos	
G64052	D		
R	06-13	SUZUKI GRAND VITARA Todos	
G64056	C		
R	06	MAZDA CX-7	
R	07-12	CX-7 Todos	
G64057	B		
R	06-15	TOYOTA HILUX	
G64058	B		
F	06-16	TOYOTA HIACE	
G64059	B		
R	06-16	TOYOTA HIACE	
G64060	D		
R	06-10	VOLKSWAGEN SPORTVAN	
G64061	D		
R	07-11	RENAULT TRAFIC	
G64062	B		
R	05-14	VOLKSWAGEN CROSSFOX	
G64063	D		
R	07-13	FORD TRANSIT	
G64064	B		
R	04-15	CHEVROLET TORNADO	
G64071	N		
R	07-08	HYUNDAI ENTOURAGE Todos	
R	06-11	KIA SEDONA Todos	
G64072	D		
R	07-13	MAZDA CX-9 Todos	

Amort.	POP	No. Alternativo	Montaje Accesorio
Pos.	Año	Aplicación	
G64074	FF		
R	03-08	LAND ROVER RANGE ROVER Todos	
G64077	FF		
R	08-11	TOYOTA SEQUOIA	
G64079	C		
R	09-14	FORD LOBO PICK UP	
R	09-14	PICKUP 1/2 TON, F-150 4x4	
R	09-12	LINCOLN MARK LT	
G64080	D		
R	07-11	ACURA MDX Todos Exc. Suspensión Activa	
G64083	C		
R	01-10	FORD COURIER	
G64084	C		
F	07-11	NISSAN CABSTAR	
G64085	C		
R	07	NISSAN CABSTAR	
R	11	CABSTAR Todos	
R	08	CABSTAR Todos	
G64087	D		143426
R	01-07	TOYOTA SEQUOIA Todos	
G64089	FF		
R	07-12	MERCEDES-BENZ SPRINTER 415 & 515	
R	10-11	VOLKSWAGEN CRAFTER Todos 50	
G64090	C		
R	05-12	VOLKSWAGEN EUROVAN	
R	10-14	TRANSPORTER Todos	
G64091	FF		
R	07-12	MERCEDES-BENZ SPRINTER 315	
R	07-10	VW CRAFTER	
R	08-13	VOLKSWAGEN CRAFTER Todos 30 - 35	
G64101	FF		
R	12-14	CHEVROLET SUBURBAN 1/2 TON, 1500 Todos	
R	12-14	TAHOE Todos	
R	12-14	GMC YUKON Todos	
R	12-14	YUKON XL 1/2 TON Todos	
G64105	FF		
R	02-06	SUZUKI XL-7 Todos	
G64107	FF		
R	15	CHEVROLET TAHOE Todos	
R	15	GMC YUKON Todos	
R	15	YUKON XL Todos	
G64111	FF		
R	11-14	FORD EDGE Todos	
R	11-14	LINCOLN MKX Todos	
G64114	FF		
R	10-13	FORD TRANSIT CONNECT Todos	
G64121	D		
R	11-13	CHEVROLET PICKUP 1 TON, SILVERADO 3500 Todos	
R	11-14	PICKUP 3/4 TON, SILVERADO 2500 Todos	
R	11-14	GMC SIERRA 2500 HD Todos	
R	11-14	SIERRA 3500 HD Todos	
G64128	N		
R	11-13	DODGE H100 DIESEL	
R	08-09	H100 DIESEL	
R	10	H100 TRUCK Truck, DIESEL	
G64129	FF		
F	11-13	DODGE H100 Todos	
F	08-09	H100 Todos	
F	10	H100 TRUCK Truck	
G64130	N		
R	12-13	DODGE H100 GAS	
R	11	H100 Todos Gas	
R	08-09	H100 Todos Gas	
R	10	H100 TRUCK Truck Gas	
G64131	N		
R	13-14	FORD RANGER Todos	
G64140	FF		
R	14-16	CHEVROLET EQUINOX Todos	
R	14-16	GMC TERRAIN Todos	

Amort.	POP	No. Alternativo	Montaje Accesorio
Pos.	Año	Aplicación	
G64143	FF		
R	13-16	HYUNDAI SANTA FE Sport, 4x2 Tracción delantera	
G64144	FF		
R	13-16	HYUNDAI SANTA FE AWD	
G64146	FF		
R	15-16	CHEVROLET CITY EXPRESS Todos	
R	13-16	NISSAN NV200 Todos	
G64154	N		
R	11-17	HONDA ODYSSEY Todos	
G64157	FF		
R	14-15	FORD LOBO PICK UP	
R	11-15	PICKUP 1/2 TON, F-150 4x2 Tracción trasera	
G64163	FF		
R	10	LEXUS RX350 Todos	
G64164	FF		
R	12-16	NISSAN NV1500	
G64181	N		
F	87-94	NISSAN ICHIVAN	
G64182	N		
R	07-11	FORD FOCUS	
G64184	N		
F	13-15	NISSAN NV350	
G64185	N		
R	13-15	NISSAN NV350	
Amortiguadores Ultra			
69407	W		142369
R	95-98	BUICK SKYLARK Todos	
R	95-96	CHEVROLET BERETTA Todos	
R	95-96	CORSICA Todos	
R	95-98	OLDSMOBILE ACHIEVA Todos Exc. Suspensión Electrónica Ajustable	
R	95-98	PONTIAC GRAND AM Todos Exc. Suspensión Electrónica Ajustable	
69416	D		
R	00-06	AUDI TT QUATTRO Todos	
69417	W		
R	94-97	VOLVO 960 Todos Fab. desde 10/94; Exc. Sistema de Autonivelación Hidráulica	
R	97-98	S90 Todos Fab. desde 5/97; Exc. Sistema de Autonivelación Hidráulica	
R	97-98	V90 Todos Fab. desde 5/97; Exc. Sistema de Autonivelación Hidráulica	
69420	W		
R	00-06	AUDI TT Todos	
69450	D		
R	00-05	TOYOTA ECHO Todos	
R	03-05	YARIS	
69462	W		
R	92-96	EAGLE SUMMIT Wagon	
R	92-95	MITSUBISHI EXPO Todos	
R	92-94	PLYMOUTH COLT Wagon	
69464	B		142950
R	08-11	FORD FOCUS Todos	
R	00-07	FOCUS Hatchback	
R	00-07	FOCUS Sedan	
69465	C		
R	00-07	FORD FOCUS Wagon	
69473	B		
R	01-10	CHRYSLER PT CRUISER Todos	
69574	D		140505
R	03-10	FORD CROWN VICTORIA Police Interceptor Modelos Policía y Taxi	
R	03-11	LINCOLN TOWN CAR Todos Modelo Limo	
69575	D		140505
R	10-11	FORD CROWN VICTORIA Base	
R	03-11	CROWN VICTORIA LX	
R	03-08	CROWN VICTORIA Base	
R	04-06	CROWN VICTORIA LX Sport	

Lista numérica

Amort.	POP	No. Alternativo	Montaje Accesorio
Pos.	Año	Aplicación	
69575	D	-continued	140505
R 05		CROWN VICTORIA S	
R 05		CROWN VICTORIA Special Edition	
R 03		CROWN VICTORIA LWB	
R 03		CROWN VICTORIA S	
R 03-11		LINCOLN TOWN CAR Todos Exc. Modelo Limo	
R 03-11		MERCURY GRAND MARQUIS Todos	
R 03-04		MARAUDER Todos	
69579	D		
R 01-04		RENAULT MEGANE	
R 01-04		SCENIC	
R 05-09		SCENIC II	
69581	C		
F 00-04		VOLKSWAGEN EUROVAN	
69582	C		
R 00-04		VOLKSWAGEN EUROVAN	
69583	C		
R 03-08		CHEVROLET MERIVA	
69585	W		
R 01-03		KIA RIO Todos	
69586	D		142155
R 01-08		AUDI A4 Todos	
R 02-08		A4 QUATTRO Todos	
69587	B		
R 05-10		CHEVROLET COBALT LS	
R 05-10		COBALT LT	
R 10		COBALT Base	
R 10		COBALT LT Team Canada	
R 06-07		COBALT LTZ	
R 05		COBALT Base	
R 11		HHR Todos	
R 08-10		HHR LS Panel	
R 08-10		HHR LT Panel	
R 06-10		HHR LS	
R 06-10		HHR LT	
R 06-08		HHR Comfort LT	
R 06-08		HHR Elegance LT	
R 07		HHR Edición Especial	
R 07-09		PONTIAC G5 Todos	
R 05-06		PURSUIT Todos	
R 08-09		SATURN ASTRA Todos	
R 03-07		ION Todos	
69589	A		
R 08		CHEVROLET MALIBU Classic LS	
R 08		MALIBU Classic LT	
R 06-07		MALIBU LTZ	
R 06-07		MALIBU SS	
R 04-07		MALIBU LS	
R 04-07		MALIBU LT	
R 04-05		MALIBU Base	
69590	B		143269
R 09-12		CHEVROLET MALIBU Todos	
R 08		MALIBU Base	
R 08		MALIBU Hybrid	
R 08		MALIBU LS	
R 08		MALIBU LT	
R 08		MALIBU LTZ	
R 04-07		MALIBU Maxx LS	
R 04-07		MALIBU Maxx LT	
R 04		MALIBU Maxx	
R 08-12		MALIBU TODOS	
R 05-10		PONTIAC G6 Todos	
R 07-09		SATURN AURA XE	
R 07-09		AURA XR	
69591	B		
R 06-12		FORD FUSION 4x2 Tracción delantera	
R 07-12		LINCOLN MKZ 4x2 Tracción delantera	
R 06		ZEPHYR Todos	
R 03-08		MAZDA 6 Todos	
R 06-11		MERCURY MILAN 4x2 Tracción delantera	
69592	C		140524
R 05-14		FORD MUSTANG / MUSTANG II Coupe	
69593	D		140524
R 05-14		FORD MUSTANG / MUSTANG II Convertible	
69594	D		
R 13		NISSAN XTERRA 4x2 Tracción trasera	

Amortiguadores Ultra

Amort.	POP	No. Alternativo	Montaje Accesorio
Pos.	Año	Aplicación	
69594	D	-continued	
R 12		XTERRA 4x2 Tracción trasera Fab. hasta 12/12	
R 08-11		XTERRA 4x2 Tracción trasera	
R 05-07		XTERRA 4x2 Tracción trasera 5.0l 8 Cyl V	
69595	C		
R 13		NISSAN XTERRA 4x4	
R 12		XTERRA 4x4 Fab. hasta 12/12	
R 05-11		XTERRA 4x4	
69600	D		140455
F 87-91		AVANTI II Todos	
F 73-75		BUICK APOLLO Todos	
F 73-81		CENTURY Todos	
F 68-72		GS / GS350 / GS400 / GS455 Todos	
F 73-87		REGAL Todos	
F 75-79		SKYLARK Todos	
F 68-72		SKYLARK Todos	
F 68-69		SPECIAL Todos	
F 68-72		SPORTWAGON Todos	
F 76-79		CADILLAC SEVILLE Todos	
F 67-69		CHEVROLET CAMARO Todos	
F 68-73		CHEVELLE Todos	
F 68		CHEVY II Todos	
F 73-83		MALIBU Todos	
F 70-88		MONTE CARLO Todos	
F 69-79		NOVA Todos	
F 64-65		NISSAN 410 Todos	
F 64-67		411 Todos	
F 68-87		OLDSMOBILE CUTLASS / CUTLASS SUPREME Todos	
F 80-83		CUTLASS CLASSIC / CUTLASS CRUISER Todos	
F 68-72		F85 Todos	
F 74-79		OMEGA Todos	
F 73		OMEGA Todos Exc. Suspensión HD	
F 68-75		VISTA CRUISER Todos	
F 82-86		PONTIAC BONNEVILLE Todos	
F 67-69		FIREBIRD Todos	
F 78-80		GRAND AM Todos	
F 73-75		GRAND AM Todos	
F 75-83		GRAND LEMANS Todos	
F 69-87		GRAND PRIX Todos	
F 71-75		GRANDVILLE Todos	
F 68-73		GTO Todos	
F 68-81		LEMANS Todos	
F 77-79		PHOENIX Todos	
F 68-70		TEMPEST Todos	
F 71-77		VENTURA Todos	
F 74-78		TOYOTA CORONA Todos	
F 73		CORONA Todos Fabricado desde 8/73	
F 69-72		CORONA Mark II	
F 68-75		VOLVO 142 / 144 / 145 / 164 Todos	
69604	D		140629
R 87-88		AVANTI II Todos	
R 73-81		BUICK CENTURY Todos	
R 71-83		ESTATE WAGON Todos	
R 65-67		GRAN SPORT Todos	
R 68-72		GS / GS350 / GS400 / GS455 Todos	
R 73-87		REGAL Todos	
R 91-96		ROADMASTER Wagon	
R 68-72		SKYLARK Todos	
R 64-67		SKYLARK Todos Suspensión HD	
R		Exc. Sportwagon	
R 68-69		SPECIAL Todos	
R 64-67		SPECIAL Todos Suspensión HD	
R		Exc. Sportwagon	
R 70-72		SPORTWAGON Todos	
R 71-72		CHEVROLET BROOKWOOD Todos	
R 71-96		CAPRICE Wagon	
R 68-73		CHEVELLE Todos	
R 64-67		CHEVELLE Todos Suspensión HD	
R 71-82		IMPALA Wagon	
R 71-72		KINGSWOOD Todos	
R 73-83		MALIBU Todos	
R 64-67		MALIBU Todos Suspensión HD	
R 70-88		MONTE CARLO Todos	
R 71-72		TOWNSMAN Todos	
R 75-76		NISSAN 610 Wagon	
R 73-74		610 Todos	
R 74-77		710 Wagon	
R 78-80		810 Wagon	
R 71-92		OLDSMOBILE CUSTOM CRUISER Todos	
R 71-87		CUTLASS / CUTLASS SUPREME Todos	
R 68-72		CUTLASS / CUTLASS SUPREME Todos Suspensión HD	
R 64-66		CUTLASS / CUTLASS SUPREME Todos Suspensión HD	

Lista numérica

Amort.	POP	No. Alternativo	Montaje Accesorio
Pos.	Año	Aplicación	
69604	D	-continued	140629
R 80-83		CUTLASS CLASSIC / CUTLASS CRUISER Todos	
R 68-72		F85 Todos	
R 64-67		F85 Todos Suspensión HD	
R 71-78		TORONADO Todos	
R 82-86		PONTIAC BONNEVILLE Todos	
R 77-81		CATALINA Wagon	
R 71-75		CATALINA Wagon	
R 78-80		GRAND AM Todos	
R 73-75		GRAND AM Todos	
R 75-83		GRAND LEMANS Todos	
R 69-87		GRAND PRIX Todos	
R 71-78		GRAND SAFARI Todos	
R 71-75		GRANDVILLE Todos	
R 68-73		GTO Todos	
R 64-67		GTO Todos Suspensión HD	
R 68-81		LEMANS Todos	
R 64-67		LEMANS Todos Suspensión HD	
R 80-86		PARISIENNE Wagon	
R 76-79		PARISIENNE Todos Wagon	
R 87-89		SAFARI Todos	
R 68-70		TEMPEST Todos	
R 64-67		TEMPEST Todos Suspensión HD	
69606	B		141150
R 64-69		BUICK SPORTWAGON Todos	
R 68-69		CHEVROLET CAMARO Todos Resorte Trasero de Hojas Múltiples	
R 65-74		FORD COUNTRY SEDAN Todos	
R 87-91		COUNTRY SQUIRE Todos	
R 65-74		COUNTRY SQUIRE Todos	
R 92-02		CROWN VICTORIA Todos	
R 65-72		CUSTOM Todos	
R 68-77		CUSTOM 500 Todos	
R 66-70		FAIRLANE Todos Wagon	
R 66-70		FALCON Todos Wagon	
R 75-76		GALAXIE	
R 65-67		GALAXIE Todos	
R 68-74		GALAXIE 500 Todos	
R 95-02		GRAND MARQUIS Todos	
R 87-91		LTD / COUNTRY SEDAN / COUNTRY SQUIRE / CROWN VICTORIA Todos	
R 67-82		LTD / COUNTRY SEDAN / COUNTRY SQUIRE / CROWN VICTORIA Todos	
R 77-79		LTD II Todos	
R 66-79		RANCHERO Todos	
R 65-74		RANCH WAGON Todos	
R 77-79		THUNDERBIRD Todos	
R 67-72		THUNDERBIRD Todos	
R 68-76		TORINO Todos	
R 70-80		LINCOLN CONTINENTAL Todos	
R 68-71		MARK III Todos	
R 72		MARK IV Todos	
R 80-83		MARK VI Todos	
R 81-02		TOWN CAR Todos	
R 67		MERCURY BROUGHAM Todos	
R 87-91		COLONY PARK Todos	
R 65-74		COLONY PARK Todos	
R 66-67		COMET Wagon	
R 65-68		COMMUTER Todos	
R 74-79		COUGAR Todos	
R 75-02		GRAND MARQUIS Todos	
R 69-70		MARAUDER Todos	
R 65-67		MARAUDER Todos	
R 67-82		MARQUIS Todos	
R 65-68		MONTECLAIR Todos	
R 68-76		MONTEGO Todos	
R 65-74		MONTEREY Todos	
R 65-68		PARKLANE Todos	
R 65-67		VILLAGER Todos	
R 66-67		VOYAGER Todos	
R 64-72		OLDSMOBILE VISTA CRUISER Todos	
R 68-69		PONTIAC FIREBIRD Todos	
69616	W		
R 77-82		PORSCHE 924 Todos	
R 83-85		944 Todos	
69622	D		
R 63-82		CHEVROLET CORVETTE Todos	
69624	W		140524
R 70-81		CHEVROLET CAMARO Todos	
R 70-81		PONTIAC FIREBIRD Todos	
69625	W		140877
F 55-57		CHEVROLET BEL AIR Todos	
F 63-82		CORVETTE Todos	
F 55-57		ONE-FIFTY SERIES Todos	
F 55-57		TWO-TEN SERIES Todos	

Lista numérica

Amort.	POP	No. Alternativo	Montaje Accesorio
Pos.	Año	Aplicación	
69632 C			
R	86-89	CHRYSLER DART	
R	82-89	DART K	
R	84-93	DAYTONA Todos	
R	83-84	E CLASS Todos	
R	85	EXECUTIVE LIMOUSINE Todos	
R	83-84	EXECUTIVE SEDAN Todos	
R	90-93	FIFTH AVENUE	
R	90-93	IMPERIAL Todos Exc. Sistema de Autonivelación NIVOMAT	
R	84-86	LASER Todos	
R	81-95	LEBARON Todos	
R	82-89	MAGNUM K	
R	88-93	NEW YORKER Todos Exc. Sistema de Autonivelación NIVOMAT	
R	83-87	NEW YORKER Todos	
R	86-94	PHANTOM	
R	88-94	SHADOW	
R	89-95	SPIRIT RT	
R	86-88	TOWN & COUNTRY Todos	
R	86-89	VOLARE	
R	82-83	DODGE 400 Todos	
R	83-88	600 Todos	
R	81-89	ARIES Todos	
R	82-89	DART K	
R	92-93	DAYTONA Iroc R/T	
R	91-93	DAYTONA Iroc	
R	89-93	DAYTONA ES	
R	89-90	DAYTONA ES Turbo	
R	87-88	DAYTONA Pacífica	
R	86	DAYTONA Turbo Z	
R	84-85	DAYTONA Turbo	
R	85-89	LANCER Todos	
R	86-89	MAGNUM K	
R	82-83	MAGNUM K	
R	87-94	SHADOW Todos	
R	89-95	SPIRIT Todos	
R	93-95	SPIRIT RT	
R	89-90	SPIRIT RT	
R	89-95	PLYMOUTH ACCLAIM Todos	
R	88	CARAVELLE 4x2 Tracción delantera	
R	83-87	CARAVELLE Todos	
R	81-89	RELIANT Todos	
R	87-94	SUNDANCE Todos	
R	84-88	VOLARE K	
69633 D 141282			
R	78-83	FORD FAIRMONT Todos	
R	81-82	GRANADA Todos	
R	83-86	LTD / COUNTRY SEDAN / COUNTRY SQUIRE / CROWN VICTORIA Todos	
R	84-93	MUSTANG / MUSTANG II LX	
R	84	MUSTANG / MUSTANG II L	
R	82-83	MUSTANG / MUSTANG II GL	
R	82-83	MUSTANG / MUSTANG II GLX	
R	79-81	MUSTANG / MUSTANG II Todos	
R	79-86	MERCURY CAPRI Todos	
R	81-82	COUGAR Base	
R	82	COUGAR GS	
R	82	COUGAR LS	
R	83-86	MARQUIS Todos	
R	78-83	ZEPHYR Todos	
69645 X			
R	76-79	PEUGEOT 504	
R	80-90	505	
R	77-82	604	
69661 W 140793			
F	68	MERCEDES-BENZ 200D Todos	
F	69-73	220 / 220D Todos W115	
F	68	220 / 220D Todos	
F	74-76	230 Todos W115	
F	69	230 Todos W115	
F	74-76	240D Todos W115	
F	73-76	280C Todos W115	
F	76	300D Todos W115	
F	75	300D Todos	
F	72	300SD / 300SDL / 300SE / 300SEL / 300TD / 350SD / 350SDL / 350SL / 380SE / 380SEC / 380SEL Todos	
F	86	300SL	
F	81-84	380SL / 380SLC Todos	
F	86	420SL	
F	74-80	450SL / 450SLC Todos	
F	89	500SL	
F	86	500SL	
69670 W 141349			
F	79-93	SAAB 900 Todos	
69671 W 141349			
R	79-80	SAAB 99 Todos	
R	93	900 Todos Fabricado antes de Jul/93	

Amortiguadores Ultra

Amort.	POP	No. Alternativo	Montaje Accesorio
Pos.	Año	Aplicación	
69671 W -continued 141349			
R	80-92	900 Todos	
69674 W 140524			
R	79-85	MAZDA RX7 Todos	
69675 C 141041			
F	71-73	BUICK CENTURION Todos	
F	71-84	ELECTRA Todos	
F	71-83	ESTATE WAGON Todos	
F	71-85	LESABRE Todos	
F	71-78	RIVIERA Todos	
F	92-96	ROADMASTER Todos	
F	91	ROADMASTER Wagon	
F	87-92	CADILLAC BROUGHAM Todos	
F	92-96	COMMERCIAL CHASSIS 4x2 Tracción trasera	
F	77-84	COMMERCIAL CHASSIS Todos	
F	77-84	DEVILLE Todos	
F	93-96	FLEETWOOD 4x2 Tracción trasera	
F	77-86	FLEETWOOD 4x2 Tracción trasera	
F	81	CHEVROLET BEL AIR Sedan Exc. Modelos Policía y Taxi	
F	71-75	BEL AIR Sedan Exc. Modelos Policía y Taxi	
F	65-70	BEL AIR Todos	
F	71-72	BISCAYNE Todos	
F	69-72	BROOKWOOD Todos	
F	70-81	CAMARO Todos	
F	66-96	CAPRICE Todos	
F	94-96	IMPALA Todos	
F	83-85	IMPALA Todos	
F	82	IMPALA Sedan	
F	65-81	IMPALA Todos	
F	69-72	KINGSWOOD Todos	
F	69-72	TOWNSMAN Todos	
F	65-74	FORD COUNTRY SEDAN Todos	
F	87-91	COUNTRY SQUIRE Todos	
F	65-74	COUNTRY SQUIRE Todos	
F	92-02	CROWN VICTORIA Todos	
F	65-72	CUSTOM Todos	
F	68-77	CUSTOM 500 Todos	
F	75-76	GALAXIE	
F	65-67	GALAXIE Todos	
F	68-74	GALAXIE 500 Todos	
F	01-02	GRAND MARQUIS Todos	
F	87-91	LTD / COUNTRY SEDAN / COUNTRY SQUIRE / CROWN VICTORIA Todos	
F	67-82	LTD / COUNTRY SEDAN / COUNTRY SQUIRE / CROWN VICTORIA Todos	
F	77-79	LTD II Todos	
F	65-74	RANCH WAGON Todos	
F	67-79	THUNDERBIRD Todos	
F	72-76	TORINO Todos	
F	70-80	LINCOLN CONTINENTAL Todos	
F	68-71	MARK III Todos	
F	72-76	MARK IV Todos	
F	77-79	MARK V Todos	
F	80-83	MARK VI Todos	
F	81-02	TOWN CAR Todos	
F	67	MERCURY BROUGHAM Todos	
F	87-91	COLONY PARK Todos	
F	65-74	COLONY PARK Todos	
F	65-68	COMMUTER Todos	
F	74-79	COUGAR Todos	
F	75-02	GRAND MARQUIS Todos	
F	69-70	MARAUDER Todos	
F	65-67	MARAUDER Todos	
F	67-82	MARQUIS Todos	
F	65-68	MONTCLAIR Todos	
F	72-76	MONTEGO Todos	
F	65-74	MONTEREY Todos	
F	65-68	PARKLANE Todos	
F	65-67	VILLAGER Todos	
F	66-67	VOYAGER Todos	
F	71-85	OLDSMOBILE 88 SERIES Todos	
F	71-84	98 Todos	
F	71-92	CUSTOM CRUISER Todos	
F	71-81	PONTIAC BONNEVILLE Todos	
F	71-81	CATALINA Todos	
F	70-81	FIREBIRD Todos	
F	71-78	GRAND SAFARI Todos	
F	76-81	LAURENTIAN Todos	
F	76-86	PARISIENNE Todos	
F	87-89	SAFARI Todos	
69676 D 142261			
R	82-02	CHEVROLET CAMARO Todos	
R	98-01	FIREBIRD TRANS AM	
R	94-96	FIREBIRD TRANS AM	
R	82-02	PONTIAC FIREBIRD Todos	
69677 W 141350			
F	72-86	JAGUAR XJ6 Todos	

Lista numérica

Amort.	POP	No. Alternativo	Montaje Accesorio
Pos.	Año	Aplicación	
69677 W -continued 141350			
F	81-92	XJ12 Todos	
F	73-79	XJ12 Todos	
F	76-96	XJS Todos	
69689 D			
R	84-91	DODGE COLT Vista, Wagon, 4x2 Tracción delantera	
R	79-83	COLT Hatchback	
R	89-91	EAGLE VISTA Wagon, 4x2 Tracción delantera	
R	86-94	HYUNDAI EXCEL Todos	
R	84-87	PONY Todos	
R	91-95	SCOUPE Todos	
R	83-88	MINI CORDIA Todos	
R	90-94	PRECIS Todos	
R	87-89	PRECIS Todos Struts Delanteros Reconstruibles de EO	
R	83-88	TREDIA Todos	
R	79-82	PLYMOUTH CHAMP Todos	
R	92-94	COLT Sedan	
R	92	COLT Hatchback	
R	85-91	COLT Todos	
R	80-84	COLT Hatchback	
69703 W 140873			
R	77-83	CHRYSLER CORDOBA Todos	
R	83-89	FIFTH AVENUE Todos	
R	81-83	IMPERIAL Todos	
R	77-80	LEBARON Todos	
R	79-81	NEWPORT Todos	
R	79-82	NEW YORKER Todos	
R	79-81	TOWN & COUNTRY Todos	
R	76-80	DODGE ASPEN Todos	
R	77-78	CHARGER Todos	
R	77-89	DIPLOMAT Todos	
R	78-79	MAGNUM Todos	
R	80-83	MIRADA Todos	
R	77-78	MONACO Todos	
R	79-81	ST. REGIS Todos	
R	88-89	PLYMOUTH CARAVELLE 4x2 Tracción trasera	
R	78-81	CARAVELLE 4x2 Tracción trasera	
R	77-78	FURY Todos	
R	80-89	GRAN FURY Todos	
R	76-80	VOLARE Todos	
69704 D			
F	80-83	CHRYSLER CORDOBA Todos	
F	77-82	DART	
F	83-89	FIFTH AVENUE Todos	
F	81-83	IMPERIAL Todos	
F	74-75	IMPERIAL Todos	
F	77-82	LEBARON Todos	
F	77-82	MAGNUM	
F	74-78	NEWPORT Todos	
F	74-82	NEW YORKER Todos	
F	74-78	TOWN & COUNTRY Todos	
F	76-80	DODGE ASPEN Todos	
F	77-82	DART	
F	77-89	DIPLOMAT Todos	
F	80-82	MAGNUM	
F	77	MAGNUM	
F	78-79	MAGNUM Todos	
F	80-83	MIRADA Todos	
F	74-76	MONACO Todos	
F	75-77	ROYAL MONACO Todos	
F	66-70	NISSAN 1600 Todos	
F	68-70	2000 Todos	
F	88-89	PLYMOUTH CARAVELLE 4x2 Tracción trasera	
F	78-81	CARAVELLE 4x2 Tracción trasera	
F	74	FURY Todos	
F	80-89	GRAN FURY Todos	
F	74-77	GRAN FURY Todos	
F	81	VALIANT	
F	77-79	VALIANT SUPER BEE	
F	76	VOLARE	
F	76-80	VOLARE Todos	
69706 W 141073			
F	79-85	BUICK RIVIERA Todos	
F	79-85	CADILLAC ELDORADO Todos	
F	80-85	SEVILLE Todos	
F	79-85	OLDSMOBILE TORONADO Todos	
69709 W 140126			
R	87-88	FORD THUNDERBIRD Non-ABS	
R	80-86	THUNDERBIRD Todos	
R	82-87	LINCOLN CONTINENTAL Todos	
R	84-92	MARK VII Todos	
R	83-88	MERCURY COUGAR Todos	
R	80-82	COUGAR XR-7	
69713 D 141045			
R	82-85	TOYOTA CELICA Todos	

Lista numérica

Amort.	POP	No. Alternativo	Montaje Accesorio
Pos.	Año	Aplicación	
R	69713	D -continued	141045
R	86	SUPRA Todos Fab. hasta 3/86	
F	69714	W	141147
F	84-87	CHEVROLET CORVETTE Todos	
R	69715	W	
R	84-87	CHEVROLET CORVETTE Todos	
R	69723	C	141277
R	82-96	BUICK CENTURY Todos	
R	80-85	SKYLARK Todos	
R	82-90	CHEVROLET CELEBRITY Todos	
R	80-85	CITATION / CITATION II Todos	
R	86-97	CUTLASS	
R	91-96	EUROSPORT	
R	82-96	OLDSMOBILE CIERA / CUTLASS CIERA Todos Exc. Suspensión Electrónica Ajustable	
R	86-97	CUTLASS	
R	87-94	CUTLASS CLASSIC / CUTLASS CRUISER Todos Exc. Suspensión Electrónica Ajustable	
R	80-84	OMEGA Todos	
R	89-91	PONTIAC 6000 4x2 Tracción delantera	
R	82-88	6000 Todos	
R	80-84	PHOENIX Todos	
R	69724	D	140629
R	89-91	AVANTI II Todos	
R	73	BUICK APOLLO Todos Suspensión HD	
R	71-73	CENTURION Todos	
R	71-84	ELECTRA Todos	
R	70	ESTATE WAGON Todos	
R	71-85	LESABRE Todos	
R	71-78	RIVIERA Todos	
R	92-96	ROADMASTER Sedan	
R	64-67	SKYLARK Todos Exc. Suspensión HD	
R	64-67	SPECIAL Todos Exc. Suspensión HD	
R	87-92	CADILLAC BROUGHAM Todos	
R	92-96	COMMERCIAL CHASSIS 4x2 Tracción trasera	
R	77-84	COMMERCIAL CHASSIS Todos	
R	77-84	DEVILLE Todos	
R	93-96	FLEETWOOD 4x2 Tracción trasera	
R	77-86	FLEETWOOD 4x2 Tracción trasera	
R	81	CHEVROLET BEL AIR Todos	
R	65-75	BEL AIR Todos	
R	65-72	BISCAYNE Todos	
R	69-70	BROOKWOOD Todos	
R	73-96	CAPRICE Sedan Modelos Policía y Taxi	
R	71-72	CAPRICE Hardtop Modelos Policía y Taxi	
R	66-70	CAPRICE Todos	
R	64-67	CHEVELLE Todos Exc. Suspensión HD	
R	68	CHEVY II Todos Resorte Trasero de Hojas Múltiples	
R	94-96	IMPALA Todos	
R	83-85	IMPALA Todos	
R	71-82	IMPALA Sedan	
R	74-81	IMPALA Coupe	
R	73	IMPALA Hardtop	
R	65-70	IMPALA Todos	
R	69-70	KINGSWOOD Todos	
R	64-67	MALIBU Todos Exc. Suspensión HD	
R	73	NOVA Todos Suspensión HD	
R	69-72	NOVA Todos Resorte Trasero de Hojas Múltiples	
R	69-70	TOWNSMAN Todos	
R	65-85	OLDSMOBILE 88 SERIES Todos	
R	65-84	98 Todos	
R	64-67	CUTLASS / CUTLASS SUPREME Todos Exc. Suspensión HD	
R	64-67	F85 Todos Exc. Suspensión HD	
R	65-66	STARFIRE Todos	
R	63-81	PONTIAC BONNEVILLE Todos	
R	75-81	CATALINA Coupe	
R	71-81	CATALINA Sedan	
R	71-74	CATALINA Hardtop	
R	63-70	CATALINA Todos	
R	67-70	EXECUTIVE Todos	
R	63-68	GRAND PRIX Todos	
R	64-67	GTO Todos Exc. Suspensión HD	
R	76-81	LAURENTIAN Todos	
R	64-67	LEMANS Todos Exc. Suspensión HD	
R	76-86	PARISIENNE Sedan	
R	63-66	STAR CHIEF Todos	
R	64-67	TEMPEST Todos Exc. Suspensión HD	

Amortiguadores Ultra

Amort.	POP	No. Alternativo	Montaje Accesorio
Pos.	Año	Aplicación	
R	69724	D -continued	140629
R	73	VENTURA Todos Suspensión HD	
R	71-72	VENTURA Todos Resorte Trasero de Hojas Múltiples	
R	69725	W	140814
R	86	BMW 318	
R	91	318I Todos	
R	84-85	318I Todos	
R	91	318IS Todos	
R	87-88	325 Todos	
R	84-87	325E Todos	
R	87-92	325i E30 (Código plataforma del fabricante) Exc. Suspensión Deportiva	
R	87-92	325iS Todos	
R	88-91	M3 Todos	
R	69726	A	
R	94-12	CHEVROLET CHEVY	
R	99-01	TIGRA	
R	69727	W	
F	84-87	PONTIAC FIERO Todos	
R	69733	W	
R	80-87	SUBARU BRAT Todos	
R	80-84	DL Todos	
R	85-89	GL Hatchback	
R	80-84	GL Todos	
R	69749	C	141277
R	93	ASUNA GT, SE+C487 Todos	
R	93	SE Todos	
R	82-89	BUICK SKYHAWK Todos	
R	86-94	SKYLARK Todos	
R	85-87	SOMERSET / SOMERSET REGAL Todos	
R	82-88	CADILLAC CIMARRON Todos	
R	92-94	CHEVROLET BERETTA Base Exc. Suspensión FE7	
R	87-91	BERETTA Todos	
R	82-94	CAVALIER Todos	
R	87-94	CORSICA Todos	
R	99-02	DAEWOO LANOS Todos	
R	92-94	OLDSMOBILE ACHIEVA Todos Exc. FE3 y Control de Manejo Electrónico	
R	85-87	CALAIS Todos	
R	88-91	CUTLASS CALAIS Todos	
R	87-88	FIRENZA Todos	
R	84-86	FIRENZA Todos Struts Reconstruibles de EO	
R	82-83	FIRENZA Todos	
R	85-94	PONTIAC GRAND AM Todos	
R	82-85	J2000 / SUNBIRD Todos	
R	86-94	SUNBIRD Todos	
R	87-91	TEMPEST Todos	
R	69755	D	141301
R	87-93	FORD MUSTANG / MUSTANG II GT, 5.0L 8Cyl V (302)	
R	84-86	MUSTANG / MUSTANG II SVO	
R	82-86	MUSTANG / MUSTANG II GT	
R	69756	W	141665,140719
R	86-95	FORD SABLE	
R	86-95	TAURUS Wagon	
R	86-95	MERCURY SABLE Wagon	
R	69757	W	140045
R	84-89	NISSAN 300ZX Todos	
R	69760	W	
R	87-88	PORSCHE 924 Todos	
R	86-91	944 Todos	
R	69766	W	140800
R	68-73	MERCEDES-BENZ 200D Todos	
R	68-73	220 / 220D Todos	
R	74-78	230 Todos	
R	68-69	230 Todos	
R	74-83	240D Todos	
R	68-70	250 Todos	
R	87-89	260E Todos Exc. Suspensión Hydromat	
R	76	280 Todos	
R	73-76	280C Todos	
R	77-81	280CE / 280E / 280S / 280SE / 280SEL Todos	
R	75-80	280CE / 280E / 280S / 280SE / 280SEL Todos Exc. Suspensión Hydromat	
R	73	280CE / 280E / 280S / 280SE / 280SEL Todos Exc. Suspensión Hydromat	

Lista numérica

Amort.	POP	No. Alternativo	Montaje Accesorio
Pos.	Año	Aplicación	
R	69766	W -continued	140800
R	72	280CE / 280E / 280S / 280SE / 280SEL Todos Fab. desde Sep/72, Exc. Suspensión Hydromat	
R	75-84	300D Todos W123	
R	78-91	300SD / 300SDL / 300SE / 300SEL / 300TD / 350SD / 350SDL / 350SL / 380SE / 380SEC / 380SEL Todos Exc. Suspensión Hydromat	
R	72	300SD / 300SDL / 300SE / 300SEL / 300TD / 350SD / 350SDL / 350SL / 380SE / 380SEC / 380SEL Todos	
R	86	300SL	
R	81-85	380SL / 380SLC Todos	
R	86-91	400E / 400SE / 400SEL / 420SEL / 450SE / 450SEL Todos Exc. Suspensión Hydromat	
R	73-80	400E / 400SE / 400SEL / 420SEL / 450SE / 450SEL Todos Exc. Suspensión Hydromat	
R	86	420SE	
R	86	420SL	
R	74-80	450SL / 450SLC Todos	
R	86	500SE	
R	87	500SEC	
R	84-91	500SEC / 500SEL / 500SEC / 560SEC / 560SEL Todos Exc. Suspensión Hydromat	
R	91	500SEL	
R	89	500SL	
R	86	500SL	
R	69773	X	142155
R	86-98	SAAB 9000 Todos Sistema Hidráulico de Autonivelación	
R	69782	D	
R	00-06	MAZDA MPV Todos	
R	69787	W	
R	75	VOLVO 142 / 144 / 145 / 164 Todos	
R	75-93	240 / 242 / 244 / 245 / 262 / 264 / 265 Todos	
R	84	DL Todos Exc. Sistema de Autonivelación NIVOMAT	
R	84	GLE Todos Exc. Sistema de Autonivelación NIVOMAT	
R	69794	W	141665
F	88	CHEVROLET CORVETTE Todos	
R	69795	W	141666
R	89-96	CHEVROLET CORVETTE Todos Exc. Suspensión Electrónica Ajustable	
R	88	CORVETTE Todos	
R	69805	W	
R	84-92	VOLVO 740 / 745 / 760 / 780 Todos Fab. desde 5/84; Exc. Sistema de Nivelación Hidráulica	
R	91-95	940 Todos Exc. Sistema de Autonivelación NIVOMAT	
R	92-94	960 Todos Fabricado antes de Oct/94 Exc. Sistema de Autonivelación NIVOMAT	
R	69811	W	141665
F	89-96	CHEVROLET CORVETTE Todos Exc. Suspensión Electrónica Ajustable	
R	69813	D	140455
R	01-05	TOYOTA RAV4 Todos	
R	00	RAV4 Todos Fabricado desde May/00	
R	69820	D	141743
R	89-91	FORD COUGAR	
R	89-91	THUNDERBIRD Todos Exc. Suspensión Electrónica Ajustable	
R	89-91	MERCURY COUGAR Todos Exc. Suspensión Electrónica Ajustable	
R	69845	D	141743
R	92-96	FORD COUGAR	
R	92-97	THUNDERBIRD Todos Exc. Suspensión Electrónica Ajustable	
R	92-97	MERCURY COUGAR Todos Exc. Suspensión Electrónica Ajustable	
R	69858	W	
R	80-91	VOLKSWAGEN VANAGON 4x2 Tracción trasera	

Lista numérica

Amort.	POP	No. Alternativo	Montaje Accesorio
Pos.	Año	Aplicación	
69861	W		141191
F	80-91	VOLKSWAGEN VANAGON 4x2 Tracción trasera	
69863	D		142155
R	92-98	BMW 318I Todos	
R	92-98	318IS Todos	
R	00	323CI Todos	
R	00	323I Wagon	
R	98-99	323I Todos	
R	01-06	325CI Todos	
R	01-05	325I Todos	
R	95	325I E36 (Código plataforma del fabricante) E36	
R	92-94	325I E36 (Código plataforma del fabricante)	
R	00	328CI Todos	
R	96-00	328I Todos	
R	01-06	330CI Todos	
R	01-05	330I Todos	
69877	D		142155
F	94-96	MERCEDES-BENZ C220 Todos	
F	97-00	C230 Todos	
F	94-00	C280 Todos	
69878	D		144151
R	94-96	MERCEDES-BENZ C220 Todos	
R	97-00	C230 Todos	
R	94-00	C280 Todos	
69884	X		140981
R	75-83	HONDA CIVIC Wagon	
69891	W		140780
R	94-98	SAAB 900 Todos	
R	93	900 Todos Fab. desde 6/30/93	
69898	C		140126
R	03-04	FORD MUSTANG / MUSTANG II Mach I	
R	94-04	MUSTANG / MUSTANG II Base	
R	94-04	MUSTANG / MUSTANG II GT	
R	04	MUSTANG / MUSTANG II GT Base	
R	04	MUSTANG / MUSTANG II GT Equipado	
R	01	MUSTANG / MUSTANG II GT Bullitt	
R	95	MUSTANG / MUSTANG II GTS	
69900	B		140455
R	01-07	FORD ESCAPE Todos	
R	01-06	MAZDA TRIBUTE Todos	
R	05-07	MERCURY MARINER Todos	
69901	W		
R	93-97	VOLVO 850 Todos Exc. Sistema de Autonivelación NIVOMAT	
R	98-04	C70 Todos	
R	98-00	S70 Todos	
R	98-00	V70 Todos Fab. hasta 3/00 y Exc. XC70, XC Cross Country	
69903	W		
R	95-99	BMW 318TI Todos	
69907	W		141716
R	01-06	HYUNDAI SANTA FE Todos	
69909	C		
R	99-04	HONDA ODYSSEY Todos	
69924	D		
R	07-08	SEAT ALHAMBRA	
69945	A		142155
R	96-97	AUDI A3	
R	98-03	A3 Todos	
R	96-99	A3 QUATTRO	
R	98-00	SEAT LEON	
R	01-07	LEON Todos	
R	96-00	TOLEDO	
R	01-06	TOLEDO Todos	
R	98-11	VOLKSWAGEN BEETLE Todos	
R	10-12	CLÁSICO	
R	99-11	GOLF	
R	99-11	GTI	
R	06-17	JETTA Sedan A4 Sedan exc. TDI	
R	99-05	JETTA A4 (Código plataforma del fabricante), Sedan A4 Sedan exc. TDI	
69946	W		141191
R	98-04	AUDI A6 Todos	
R	98-05	VOLKSWAGEN PASSAT 4x2 Tracción delantera Desde Número de Identificación de Vehículo (VIN) #3B300001 al #3B300000	

Amortiguadores Ultra

Amort.	POP	No. Alternativo	Montaje Accesorio
Pos.	Año	Aplicación	
69952	W		
F	96-99	MERCEDES-BENZ E300 Todos	
F	96-02	Exc. Suspensión Deportiva E320 Sedan Exc. Suspensión Deportiva	
F	96-97	E320 Todos Exc. Suspensión Deportiva	
F	97	E420 Todos Exc. 4 Matic	
F	98-02	E430 Todos Exc. Suspensión Deportiva	
69962	D		141727,141354
R	02-05	FORD SABLE	
R	96-01	SABLE Todos Wagon	
R	96-05	TAURUS Wagon	
R	96-05	MERCURY SABLE Wagon	
69966	W		
R	99	MERCEDES-BENZ E300 Todos	
R		Exc. 4 Matic	
R	96-98	E300 Todos	
R	96-02	E320 Sedan	
R	97	E420 Todos	
R	98-02	E430 Todos	
69995	W		144151
R	84-89	MERCEDES-BENZ 190D Todos	
R	84-93	190E Todos	
R	91	230E	
R	86-89	230E	
R	86	250D	
R	92	260E	
R	87-89	260E Todos 4 Matic	
R	89	300D	
R	86	300D	
R	90-93	300D Todos W115 4 Matic	
R	87	300D Todos W115 4 Matic	
R	84-85	300D Todos W115 4 Matic	
R	86-93	300E Todos	
69996	W		140800,142628
F	77-78	MERCEDES-BENZ 230 Todos Exc. W115	
F	76-83	240D Todos W123	
F	87-89	260E Todos Exc. Suspensión Hydromat	
F	89	260SE	
F	87	260SE	
F	76	280 Todos	
F	76	280C Todos Exc. W115	
F	77-81	280CE / 280E / 280S / 280SE / 280SEL Todos	
F	75-80	280CE / 280E / 280S / 280SE / 280SEL Todos Exc. Suspensión Hydromat	
F	73	280CE / 280E / 280S / 280SE / 280SEL Todos Exc. Suspensión Hydromat	
F	72	280CE / 280E / 280S / 280SE / 280SEL Todos Fab. desde Sep/72, Exc. Suspensión Hydromat	
F	77-84	300D Todos	
F	76	300D Todos W123	
F	78-91	300SD / 300SDL / 300SE / 300SEL / 300TD / 350SD / 350SDL / 350SL / 380SE / 380SEC / 380SEL Todos	
F	79-85	Exc. Suspensión Hydromat 300SD / 300SDL / 300SE / 300SEL / 300TD / 350SD / 350SDL / 350SL / 380SE / 380SEC / 380SEL Todos	
F	86-91	400E / 400SE / 400SEL / 420SEL / 450SE / 450SEL Todos Exc. Suspensión Hydromat	
F	73-80	400E / 400SE / 400SEL / 420SEL / 450SE / 450SEL Todos Exc. Suspensión Hydromat	
F	86	500SE	
F	87	500SEC	
F	84-91	500SEC / 500SEL / 500SEC / 560SEC / 560SEL Todos Exc. Suspensión Hydromat	
F	91	500SEL	
69998	W		
R	01-03	BMW 525I Wagon Exc. Suspensión Electrónica Ajustable	
R	99-00	528I Wagon	
R	00-03	540I Wagon Exc. Suspensión Electrónica Ajustable	
70000	D		
R	02-05	KIA SEDONA Todos	
70001	D		
R	04-05	KIA RIO Todos	

Lista numérica

Amort.	POP	No. Alternativo	Montaje Accesorio
Pos.	Año	Aplicación	
70002	B		
R	03-14	RENAULT KANGOO	
70003	B		
R	08-09	MAZDA 3 GS	
R	08-09	3 GT	
R	08-09	3 GX	
R	07-09	3 i	
R	07-09	3 S	
R	04-06	3 Todos	
R	06-10	5 Todos	
70004	D		
R	03-08	FIAT PALIO	
70005	D		
R	03-08	CHEVROLET VECTRA	
70006	D		
R	04-10	RENAULT MEGANE II	
70007	B		
R	03-08	SEAT CORDOBA	
R	03-14	IBIZA	
R	05-09	VOLKSWAGEN LUPO	
R	03-08	POLO	
70009	C		
R	03-12	PEUGEOT GRAND RAID	
R	03-09	PARTNER Todos	
70010	B		
R	05-10	HONDA ODYSSEY Todos	
70011	C		
R	07	NISSAN 120I	
R	08-10	APRIO	
R	10-12	RENAULT SANDERO / SANDERO STEPWAY	
70013	D		
R	06-11	HYUNDAI AZERA Todos	
R	06-10	SONATA Todos	
70015	A		
R	06-15	CHEVROLET MATIZ G2	
R	06-13	PONTIAC G2	
70020	N		142154
R	01-02	SAAB 9-3 Turbo	
R	99-02	9-3 SE	
R	99-01	9-3 Base	
70023	W		
F	94-99	MERCEDES-BENZ S320 / S350 / S420 / S500 / S600 Todos Exc. Control de Manejo Electrónico	
70024	W		
R	94-99	MERCEDES-BENZ S320 / S350 / S420 / S500 / S600 Todos Exc. Control de Manejo Electrónico	
70027	A		
R	07-12	NISSAN SENTRA Base	
R	07-12	SENTRA S	
R	07-12	SENTRA SL	
70028	N		
R	04-06	SCION XA Todos	
R	04-06	XB Todos	
70031	D		
R	03-13	CADILLAC CTS Todos Exc. Suspensión Magnética de Control de Manejo	
70032	N		
R	04-06	PONTIAC GTO Todos	
70033	D		
R	02-07	MERCEDES-BENZ C230 Todos	
R	01-05	C240 4x2 Tracción trasera	
R	06-07	C280 4x2 Tracción trasera	
R	01-05	C320 4x2 Tracción trasera	
R	06-07	C350 4x2 Tracción trasera	
R	03-05	CLK320 Todos	
R	06-09	CLK350 Todos	
R	03	CLK430 Todos	
R	02	CLK430 Todos Fab. desde 4/02	
R	03-06	CLK500 Todos	
R	07-09	CLK550 Todos	
70034	D		
R	04-10	BMW X3 Todos	
70036	B		
R	06-11	DODGE ATTITUDE Todos	

Lista numérica

Lista numérica

Amort.	POP	No. Alternativo	Montaje Accesorio
Pos.	Año	Aplicación	
70036	B	-continued	
R	06-11	HYUNDAI ACCENT Todos	
R	06-11	KIA RIO Todos	
R	06-11	RIO Todos	
70037	D		
R	07-10	HYUNDAI ELANTRA Todos	
70038	D		
R	12	MERCEDES-BENZ C250 Sedan, CGI (FuelDelSubType)	
R	10-11	C250 Todos	
R	08-09	C280 Todos	
R	08-11	C300 Todos	
R	12	C350 CGI (FuelDelSubType)	
R	08-11	C350 Todos	
70039	N		
R	03-11	SAAB 9-3 Todos	
70040	D		
R	04-09	VOLVO S60 4x2 Tracción delantera	
R	01-03	S60 Todos	
R	01-07	V70 Todos Exc. Suspensión Electrónica / Nivomat	
70041	A		
R	06	NISSAN TIIDA	
R	07-11	TIIDA Todos	
R	12	VERSA Todos	
R	07-11	VERSA S	
R	07-11	VERSA SL	
70045	C		
R	08-11	BMW 128i Todos	
R	05-13	135i	
R	06-14	325i	
R	07-13	328i Todos	
R	07-11	330i	
R	07-13	335i Todos	
70049	FF		
R	07-10	KIA MAGENTIS Todos	
R	07-10	OPTIMA Todos	
R	07-11	RONDO Todos	
70052	B		
R	11-14	FORD FIESTA Todos	
R	11-14	MAZDA 2 Todos	
70053	D		
R	08-12	SCION XB Todos	
R	10-13	TOYOTA PRIUS Todos Ruedas de 17"	
70055	FF		
R	08-10	SCION XD Todos	
R	12-14	TOYOTA PRIUS C Todos	
70056	D		
R	07-13	VOLVO C30 Todos	
R	06-11	C70 Todos	
R	05-12	S40 Todos	
R	04	S40 i	
R	04-12	V50	
70059	D		
R	10	BUICK ALLURE 4x2 Tracción delantera	
R	12-13	LACROSSE 4x2 Tracción delantera Exc. Suspensión Electrónica	
R	10-11	LACROSSE 4x2 Tracción delantera	
70060	D		
R	07-08	HONDA FIT Todos	
70061	D		
R	07-13	VOLKSWAGEN EOS Todos Exc. Suspensión Electrónica	
70063	B		
R	10-15	CHEVROLET SPARK	
70064	FF		
F	98-03	MERCEDES-BENZ CLK320 Todos	
F	99-02	CLK430 Todos	
F	98-04	SLK230 Todos	
F	03-04	SLK320 Todos	
F	01-02	SLK320 170.465 (Código plataforma del fabricante)	
70065	FF		
R	98-02	MERCEDES-BENZ CLK320 Todos	
R	99-02	CLK430 Todos	
R	98-04	SLK230 Todos	
R	03-04	SLK320 Todos	

Amort.	POP	No. Alternativo	Montaje Accesorio
Pos.	Año	Aplicación	
70065	FF	-continued	
R	01-02	SLK320 170.465 (Código fabricante)	
70067	FF		
R	10-13	HONDA CIVIC Todos	
70068	N		
R	12-14	HYUNDAI AZERA Todos	
R	11-14	SONATA Todos	
R	14	KIA CADENZA Todos	
R	11	OPTIMA Todos	
70072	W		
R	08-13	PEUGEOT 207	
70073	B		
R	12-15	NISSAN MARCH Todos	
70074	C		
R	07-11	TOYOTA AVANZA	
70077	FF		
R	11-16	NISSAN QUEST Todos	
70078	FF		
R	07-09	KIA SORENTO Todos Exc. HPD (High Performance Dampers)	
70086	FF		
R	05-10	CHRYSLER 300 Todos	
70087	D		
R	05-08	FIAT PALIO	
70089	FF		
R	09-12	NISSAN ALTIMA Todos	
R	09-14	MAXIMA Todos	
70095	FF		
R	12-14	DODGE ATTITUDE Todos	
R	14-16	HYUNDAI ACCENT Todos	
R	14-15	KIA RIO Todos	
70096	FF		
R	10-14	FORD TAURUS Todos w/ Suspensión Code A y B	
70098	FF		
R	11-13	HYUNDAI ELANTRA Todos Exc. Ruedas de 16 y 17"	
R	13	ELANTRA COUPE Todos Exc. Ruedas de 16 y 17"	
70101	FF		
R	06-11	MERCEDES-BENZ B CLASS B200	
70103	W		
R	09-12	FIAT 500 Todos	
70105	FF		
R	10-14	VOLKSWAGEN TRANSPORTER Todos	
70110	FF		
R	12-15	MAZDA 6 Todos	
70118	N		
R	12-14	HYUNDAI I10	
70127	FF		
R	13-17	VOLKSWAGEN. VENTO	
Amortiguadores Guardian Hidráulicos Reforzados			
70159	B		
F	02-06	NISSAN URVAN	
70160	B		
R	10	NISSAN URVAN	
R	07-08	URVAN	
70161	A		
F	81-82	CHEVROLET LUV PICKUP 4x2 Tracción trasera	
F	81-95	ISUZU PICKUP	
F	69-72	NISSAN 521 PICKUP	
F	75-79	620	
F	72-74	620 PICKUP	
F	80-86	720 PICKUP Todos	
F	65-12	PICKUP	
70162	C		
R	69-72	NISSAN 521 PICKUP	
R	75-79	620	
R	72-79	620 PICKUP	
R	85-86	720 PICKUP Todos	
R	82-84	720 PICKUP 4x2 Tracción trasera	
R	80-81	720 PICKUP Todos	

Amort.	POP	No. Alternativo	Montaje Accesorio
Pos.	Año	Aplicación	
70163	A		
R	75-80	CHEVROLET LUV PICKUP Todos	
R	72-74	LUV PICKUP	
R	79-82	DODGE D50 4x2 Tracción trasera	
R	83-93	RAM 50	
R	86-87	MAZDA B2000	
R	87-93	B2200	
R	87-93	B2600	
R	83-96	MITSUBISHI MIGHTY MAX	
R	87-90	VAN	
R	98-04	NISSAN FRONTIER 4x2 Tracción trasera Exc. Desert Runner	
R	87-93	ICHIVAN	
R	05-12	PICKUP	
R	84-94	PICKUP	
R	02-13	URVAN	
R	79-82	PLYMOUTH ARROW PICKUP	
R	85-95	TOYOTA PICKUP	
R	84	PICKUP 4x2 Tracción trasera	
R	70-83	PICKUP Todos 4x2 Tracción trasera; Mojave	
R	84-88	VAN	
R	88	VAN WAGON	
70164	B		
F	87-91	CHEVROLET C10	
F	73-91	C10 SUBURBAN	
F	73-91	C15	
F	75-91	C20	
F	73-91	C25	
F	63-91	C30	
F	73-91	C35	
F	73-91	C1500	
F	73-91	C2000	
F	73-91	C2500	
F	73-91	C3000	
F	73-91	C3500	
F	73-91	CHEYENE HUNTER	
F	63-72	P20	
F	63-91	P30	
F	79-86	PICKUP 1/2 TON, C10 Todos	
F	63-74	PICKUP 1/2 TON, C10 Todos	
F	63-74	PICKUP 3/4 TON, C20 Todos	
F	63-72	PS300	
F	63-72	VAN 1/2 TON, P SERIES Todos	
70165	C		
R	73-91	CHEVROLET BLAZER	
R	73-91	C10 SUBURBAN	
R	73-91	C15	
R	73-91	C20	
R	73-91	C25	
R	73-91	C1500	
R	73-91	C2000	
R	73-91	C2500	
R	73-91	CHEYENE HUNTER	
70166	D		
F	72-93	DODGE ADVENTURER PROSPECTOR	
F	72-93	D100	
F	72-93	D150	
F	72-93	D250	
F	81-93	D300	
F	81-93	D350	
F	81-93	D350 MINIBUS	
F	97-01	RAM VAN	
F	99-03	RAM VAN 1500, 2500 Y 3500	
F	97-01	RAM WAGON Y VAN	
70167	D		
R	72-93	DODGE ADVENTURER PROSPECTOR	
R	73-93	D100	
R	72-93	D150	
R	72-93	D250	
R	72-93	D300	
R	72-93	D350	
R	81-93	D350 MINIBUS	
R	95-96	RAMCHARGER	
R	88-90	RAMCHARGER	
R	97-01	RAM VAN	
R	97-01	RAM WAGON Y VAN	
70169	C		
F	85-91	FORD E-250 ECONOLINE	
F	85-91	E-350 ECONOLINE	
F	72-79	F-150	
F	72-79	F-250	
F	67-97	F-350 PICKUP	
70170	D		
R	75-91	FORD E-100 ECONOLINE	
R	75-91	E-150 ECONOLINE	

Lista numérica

Lista numérica

Amort.	POP	No. Alternativo	Montaje Accesorio
Pos.	Año	Aplicación	
70171	C		
R	83-05	CHEVROLET	S10 BLAZER
F	83-05	GMC	S15 JIMMY
70172	D		
R	67-79	FORD	F-350 PICKUP
R	84-91	JEEP	GRAND WAGONEER
R	74-88		J10
R	74-88		J20
R	84-91		PICKUP
70173	C		
R	83-05	CHEVROLET	S10 BLAZER
R	83-05	GMC	S15 JIMMY
70175	W		
R	61-72	DODGE	D100
R	61-72		D300
R	74		M300
F	86-89		PICKUP 1/2 TON, W100 SERIES Todos Exc. Kit de Levantamiento
F	61-74		PICKUP 1/2 TON, W100 SERIES Todos
F	61-80		PICKUP 1 TON, W300 SERIES Todos
R	61-71		PICKUP 1 TON, W300 SERIES Todos
R	61-71		PICKUP 3/4 TON, D200 SERIES Todos Susp. Del. con muelles hasta 1a. Serie 72
F	81-93		PICKUP 3/4 TON, W200 SERIES Standard Cab Pickup Exc. Kit de Levantamiento
F	69-74		PICKUP 3/4 TON, W200 SERIES Todos
F	61-67		PICKUP 3/4 TON, W200 SERIES Todos
F	74		RAMCHARGER
F	75-93		RAMCHARGER 4x4
F	78-80		RD200
F	75-77		W100
F	77-93		W150
F	75-80		W200
F	81-93		W350
F	74-81		PLYMOUTH TRAILDUSTER
70176	D		
F	72-80	DODGE	B300
F	81-93		B350
F	70-80		CB-300
F	72-80		D200 HEAVY DUTY
F	72-93		D250 HEAVY DUTY
F	72-80		D300
F	81-93		D350
F	81-93		MB-300
F	81-93		MB-350
F	70-80		MB-400
F	74-80		PB300 VAN
F	81-83		PB350 VAN
Amortiguador Monotubo MaxControl			
75676	W		142261
R	82-02	CHEVROLET	CAMARO Todos
R	82-02	PONTIAC	FIREBIRD Todos
75755	X		141301
R	93	FORD	MUSTANG / MUSTANG II GT, 5.0L 8Cyl V (302)
R	93		MUSTANG / MUSTANG II LX, 5.0L 8Cyl V (302)
R	87-92		MUSTANG / MUSTANG II 5.0L 8Cyl V (302)
R	84-86		MUSTANG / MUSTANG II SVO
R	82-86		MUSTANG / MUSTANG II GT
75795	X		141666
R	89-96	CHEVROLET	CORVETTE Todos Exc. Suspensión Electrónica Ajustable
R	88		CORVETTE Todos
75811	W		141665
F	89-96	CHEVROLET	CORVETTE Todos Exc. Suspensión Electrónica Ajustable
F	84-87		CORVETTE Todos
75898	W		140126
R	03-04	FORD	MUSTANG / MUSTANG II Mach I
R	94-04		MUSTANG / MUSTANG II Base
R	94-04		MUSTANG / MUSTANG II GT
R	04		MUSTANG / MUSTANG II GT Base
R	04		MUSTANG / MUSTANG II GT Equipado
R	01		MUSTANG / MUSTANG II GT Bullitt

Amort.	POP	No. Alternativo	Montaje Accesorio
Pos.	Año	Aplicación	
75898	W		-continued 140126
R	95		MUSTANG / MUSTANG II GTS
77183	W		
F	81-93	DODGE	PICKUP 1/2 TON, W100 SERIES Todos Exc. Kit de Levantamiento
F	61-80		PICKUP 1/2 TON, W100 SERIES Todos
F	81-93		PICKUP 1 TON, W300 SERIES Todos Exc. Suspensión Quad y Kit de Levantamiento
F	72-80		PICKUP 1 TON, W300 SERIES Todos
R	64-71		PICKUP 1 TON, W300 SERIES Todos
F	61-67		PICKUP 1 TON, W300 SERIES Todos
F	90-93		PICKUP 3/4 TON, W200 SERIES Extended Cab Pickup Exc. Kit de Levantamiento
F	88-93		PICKUP 3/4 TON, W200 SERIES Cab & Chassis Exc. Kit de Levantamiento
F	81-93		PICKUP 3/4 TON, W200 SERIES Standard Cab Pickup Exc. Kit de Levantamiento
F	86		PICKUP 3/4 TON, W200 SERIES Cab & Chassis Exc. Kit de Levantamiento
F	81-83		PICKUP 3/4 TON, W200 SERIES Cab & Chassis Exc. Kit de Levantamiento
F	81-82		PICKUP 3/4 TON, W200 SERIES Extended Cab Pickup Exc. Kit de Levantamiento
F	69-80		PICKUP 3/4 TON, W200 SERIES Todos
F	61-67		PICKUP 3/4 TON, W200 SERIES Todos
77349	W		140357
R	87-91	CHEVROLET	BLAZER Todos Automóvil Grande; Exc. Suspensión Quad y Kit de Levantamiento
R	73-86		BLAZER Todos Exc. Kit de Levantamiento
R	79-84		CS1073
R	73-86		PICKUP 1/2 TON, C10 Todos
R	73-86		PICKUP 1/2 TON, K10 Todos Exc. Suspensión Quad y Kit de Levantamiento
R	87		PICKUP 1/2 TON, R10 Todos
R	87		PICKUP 1/2 TON, V10 Todos Exc. Suspensión Quad y Kit de Levantamiento
R	75-86		PICKUP 3/4 TON, C20 Standard Cab Pickup
R	73-74		PICKUP 3/4 TON, C20 Todos Standard Cab Pickup
R	73-86		PICKUP 3/4 TON, K20 Todos Exc. Suspensión Quad y Kit de Levantamiento
R	87		PICKUP 3/4 TON, R20 Standard Cab Pickup
R	87		PICKUP 3/4 TON, V20 Todos Exc. Suspensión Quad y Kit de Levantamiento
R	73-86		SUBURBAN 1/2 TON, C10 Todos
R	73-86		SUBURBAN 1/2 TON, K10 Todos Exc. Suspensión Quad y Kit de Levantamiento
R	87-88		SUBURBAN 1/2 TON, R10 Todos
R	89-91		SUBURBAN 1/2 TON, R1500 Todos
R	89-91		SUBURBAN 1/2 TON, V1500 Todos Exc. Suspensión Quad y Kit de Levantamiento
R	73-86		SUBURBAN 3/4 TON, C20 Todos
R	73-86		SUBURBAN 3/4 TON, K20 Todos Exc. Suspensión Quad y Kit de Levantamiento
R	87-88		SUBURBAN 3/4 TON, R20 Todos
R	89-91		SUBURBAN 3/4 TON, R2500 Todos
R	87-88		SUBURBAN 3/4 TON, V20 Todos Exc. Suspensión Quad y Kit de Levantamiento
R	89-91		SUBURBAN 3/4 TON, V2500 Todos Exc. Suspensión Quad y Kit de Levantamiento
R	73		VAN 1/2 TON, P SERIES Todos
R	73-78		VAN 3/4 TON, P SERIES Todos
R	73-91		GMC JIMMY Todos Exc. Kit de Levantamiento
R	73-86		PICKUP 1/2 TON, C15 / C1500 Todos

Amort.	POP	No. Alternativo	Montaje Accesorio
Pos.	Año	Aplicación	
77349	W		-continued 140357
R	73-86		PICKUP 1/2 TON, K15 / K1500 Todos Exc. Kit de Levantamiento
R	87		PICKUP 1/2 TON, R1500 Todos
R	87		PICKUP 1/2 TON, V1500 Todos Exc. Kit de Levantamiento
R	75-86		PICKUP 3/4 TON, C25 / C2500 Cab & Chassis
R	75-86		PICKUP 3/4 TON, C25 / C2500 Standard Cab Pickup
R	73-74		PICKUP 3/4 TON, C25 / C2500 Todos Exc. Crew Cab y Bonus Cab
R	73-86		PICKUP 3/4 TON, K25 / K2500 Todos Exc. Kit de Levantamiento
R	88-89		PICKUP 3/4 TON, R2500 Todos Exc. Crew Cab y Bonus Cab
R	87		PICKUP 3/4 TON, R2500 Cab & Chassis Exc. Crew Cab y Bonus Cab
R	87		PICKUP 3/4 TON, R2500 Standard Cab Pickup Exc. Crew Cab y Bonus Cab
R	87		PICKUP 3/4 TON, V2500 Todos Exc. Kit de Levantamiento
R	73-86		SUBURBAN 1/2 TON, C15 / C1500 Todos
R	73-86		SUBURBAN 1/2 TON, K15 / K1500 Todos Exc. Kit de Levantamiento
R	87-91		SUBURBAN 1/2 TON, R1500 Todos
R	87-91		SUBURBAN 1/2 TON, V1500 Todos Exc. Kit de Levantamiento
R	75-86		SUBURBAN 3/4 TON, C25 / C2500 Todos
R	73-74		SUBURBAN 3/4 TON, C25 / C2500 Todos Exc. Crew Cab y Bonus Cab
R	73-86		SUBURBAN 3/4 TON, K25 / K2500 Todos Exc. Kit de Levantamiento
R	87-91		SUBURBAN 3/4 TON, R2500 Todos
R	87-91		SUBURBAN 3/4 TON, V2500 Todos Exc. Kit de Levantamiento
R	73		VAN 1/2 TON, P SERIES Todos
R	73-78		VAN 3/4 TON, P SERIES Todos
77355	W		140702
F	75-84	CHEVROLET	BLAZER 4x2 Tracción trasera
F	69-74		BLAZER Todos 4x2 Tracción trasera
F	63-86		PICKUP 1/2 TON, C10 Todos
F	87		PICKUP 1/2 TON, R10 Todos
F	63-86		PICKUP 1 TON, C30 Todos
F	88-91		PICKUP 1 TON, C35/3500 Cab & Chassis
F	87-88		PICKUP 1 TON, R30 Todos
F	89		PICKUP 1 TON, R3500 Standard Cab Pickup
F	75-86		PICKUP 3/4 TON, C20 Crew Cab Pickup
F	75-86		PICKUP 3/4 TON, C20 Standard Cab Pickup
F	63-74		PICKUP 3/4 TON, C20 Todos
F	88		PICKUP 3/4 TON, R20 Todos
F	87		PICKUP 3/4 TON, R20 Crew Cab Pickup
F	89		PICKUP 3/4 TON, R2500 Todos
F	63-66		SUBURBAN 1/2 TON, 1500 Todos
F	67-86		SUBURBAN 1/2 TON, C10 Todos
F	68-86		SUBURBAN 1/2 TON, K10 Todos
F	87-88		SUBURBAN 1/2 TON, R10 Todos
F	89-91		SUBURBAN 1/2 TON, R1500 Todos
F	68-86		SUBURBAN 3/4 TON, C20 Todos
F	68-86		SUBURBAN 3/4 TON, K20 Todos Exc. Suspensión Quad y Kit de Levantamiento
F	87-88		SUBURBAN 3/4 TON, R20 Todos
F	89-91		SUBURBAN 3/4 TON, R2500 Todos
F	63-80		VAN 1/2 TON, P SERIES Todos
F	73-90		VAN 1 TON, P SERIES Todos Exc. Chasis Motorhome
F	68-72		VAN 1 TON, P SERIES Todos
F	68-89		VAN 3/4 TON, P SERIES Todos
F	66		GMC C25/C2500 PICKUP
F	75-84		JIMMY 4x2 Tracción trasera
F	70-74		JIMMY Todos 4x2 Tracción trasera
F	67-86		PICKUP 1/2 TON, C15 / C1500 Todos
F	87		PICKUP 1/2 TON, R1500 Todos
F	88-91		PICKUP 1 TON, C35/3500 Cab & Chassis
F	67-78		PICKUP 1 TON, C35/3500 Todos
F	87-91		PICKUP 1 TON, R3500 Todos
F	85-86		PICKUP 3/4 TON, C25 / C2500 Crew Cab Pickup
F	75-86		PICKUP 3/4 TON, C25 / C2500 Cab & Chassis

Lista numérica

Amort.	POP	No. Alternativo	Montaje Accesorio
Pos.	Año	Aplicación	
77355	W	-continued	140702
F	75-86	PICKUP 3/4 TON, C25 / C2500 Standard Cab Pickup	
F	75-83	PICKUP 3/4 TON, C25 / C2500 Crew Cab Pickup	
F	67-74	PICKUP 3/4 TON, C25 / C2500 Todos	
F	87-89	PICKUP 3/4 TON, R2500 Todos Exc. Crew Cab y Bonus Cab	
F	63-65	PICKUP 1500 SERIES Todos	
F	68-86	SUBURBAN 1/2 TON, C15 / C1500 Todos	
F	87-91	SUBURBAN 1/2 TON, R1500 Todos	
F	68-86	SUBURBAN 3/4 TON, C25 / C2500 Todos	
F	87-91	SUBURBAN 3/4 TON, R2500 Todos	
F	67-80	VAN 1/2 TON, P SERIES Todos	
F	75-90	VAN 1 TON, P SERIES Todos Exc. Chasis Motorhome	
F	73-74	VAN 1 TON, P SERIES Base Exc. Chasis Motorhome	
F	68-72	VAN 1 TON, P SERIES Todos	
F	68-89	VAN 3/4 TON, P SERIES Todos	
F	63-65	VAN, PB 1000 SERIES Todos	
77357	W		
F	71-95	CHEVROLET VAN 1/2 TON, G / EXPRESS Todos	
F	70	VAN 1/2 TON, G / EXPRESS Todos Suspensión Delantera Independiente	
F	78-95	VAN 1 TON, G / EXPRESS Todos	
F	75	VAN 1 TON, G / EXPRESS 146.0 (WheelBase)	
F	71-74	VAN 1 TON, G / EXPRESS Todos	
F	78-95	VAN 3/4 TON, G / EXPRESS Todos Exc. PBV 8600 #	
F	71-77	VAN 3/4 TON, G / EXPRESS Todos	
F	70	VAN 3/4 TON, G / EXPRESS Todos Suspensión Delantera Independiente	
F	71-95	GMC VAN 1/2 TON, G / SAVANNA Todos	
F	70	VAN 1/2 TON, G / SAVANNA Todos Suspensión Delantera Independiente	
F	71-95	VAN 1 TON, G / SAVANNA Todos	
F	78-95	VAN 3/4 TON, G / SAVANNA Todos Exc. PBV 8600 #	
F	71-77	VAN 3/4 TON, G / SAVANNA Todos	
F	70	VAN 3/4 TON, G / SAVANNA Todos Suspensión Delantera Independiente	
77359	W		140126
F	84-86	DODGE MINI RAM Todos	
F	72-93	PICKUP 1/2 TON, D100 SERIES Todos	
F	90-93	PICKUP 3/4 TON, D200 SERIES Todos Exc. Paquete HD	
F	82-89	PICKUP 3/4 TON, D200 SERIES Todos	
F	72-81	PICKUP 3/4 TON, D200 SERIES Todos Exc. Paquete HD	
F	75-93	RAMCHARGER 4x2 Tracción trasera	
F	99-03	VAN 1/2 TON, A / B SERIES / RAM 109.3 (WheelBase) Exc. PBV 7000#	
F	81-98	VAN 1/2 TON, A / B SERIES / RAM 109.6 (WheelBase) Exc. PBV 7000#	
F	71-80	VAN 1/2 TON, A / B SERIES / RAM Todos	
F	99-03	VAN 1 TON, A / B SERIES / RAM Todos	
F	71-98	VAN 1 TON, A / B SERIES / RAM Todos Exc. Eje Delantero 4000#	
F	71-03	VAN 3/4 TON, A / B SERIES / RAM Todos	
F	74-80	VAN, CB300 Todos Exc. Eje Delantero 4000#	
F	81	PLYMOUTH TRAILDUSTER Todos	
F	75-80	TRAILDUSTER 4x2 Tracción trasera	
F	74-83	VAN 1/2 TON, PB SERIES Todos	
F	74-83	VAN 1 TON, PB SERIES Todos Exc. Eje Delantero 4000#	
F	74-83	VAN 3/4 TON, PB SERIES Todos	
77375	W		140780
F	85-05	CHEVROLET ASTRO 4x2 Tracción trasera	
F	81	BEL AIR Todos	
F	71-75	BEL AIR Todos	
F	71-72	BISCAYNE Todos	
F	80-96	CAPRICE Sedan Modelos Policía y Taxi	
F	78-79	CAPRICE Sedan	
F	73-77	CAPRICE Sedan Modelos Policía y Taxi	

Amortiguador Monotubo MaxControl

Amort.	POP	No. Alternativo	Montaje Accesorio
Pos.	Año	Aplicación	
77375	W	-continued	140780
F	71-72	CAPRICE Todos Sedan; Modelos Policía y Taxi	
F	71-85	IMPALA Sedan Modelos Policía y Taxi	
F	96-02	VAN 1/2 TON, G / EXPRESS Todos	
F	97-02	VAN 1 TON, G / EXPRESS Todos	
F	96	VAN 1 TON, G / EXPRESS Todos Exc. PBV 8600 #	
F	96-02	VAN 3/4 TON, G / EXPRESS Todos Exc. PBV 8600 #	
F	93-02	FORD CROWN VICTORIA Police Interceptor Modelos Policía y Taxi	
F	85-05	GMC SAFARI 4x2 Tracción trasera	
F	96-02	VAN 1/2 TON, G / SAVANNA 4x2 Tracción trasera	
F	96-02	VAN 1 TON, G / SAVANNA Todos	
F	96-02	VAN 3/4 TON, G / SAVANNA Todos Exc. PBV 8600 #	
77377	W		141137
R	78-79	FORD BRONCO Todos Exc. Kit de Levantamiento	
R	66-77	BRONCO Todos Desde Serie #830001; Exc. Kit de Levantamiento	
R	75-79	PICKUP 1 TON, F-350 / SUPERDUTY Standard Cab Pickup, 4x2 Tracción trasera	
R	75-79	PICKUP 3/4 TON, F-250 / SUPERDUTY 4x2 Tracción trasera	
R	69-74	VAN 1/2 TON, ECONOLINE / CLUB WAGON Todos	
R	69-74	VAN 1 TON, ECONOLINE / CLUB WAGON / SUPERDUTY Todos	
R	69-74	VAN 3/4 TON, ECONOLINE / CLUB WAGON / SUPERDUTY Todos	
R	76-83	JEEP CHEROKEE Todos	
F	74-83	CHEROKEE Todos	
F	82-83	CJ5 Todos Exc. Kit de Levantamiento	
F	82-86	CJ7 Todos Exc. Kit de Levantamiento	
F	84-91	GRAND WAGONEER Todos	
F	84-91	GRAND WAGONEER Todos	
R	74-88	J10 PICKUP Todos	
R	74-88	J10 PICKUP Todos	
R	74-88	J20 PICKUP Todos	
R	74-88	J20 PICKUP Todos	
F	82-85	SCRAMBLER / CJ8 Todos	
R	76-83	WAGONEER Todos	
F	74-83	WAGONEER Todos	
77389	W		
R	81-93	DODGE PICKUP 1/2 TON, W100 SERIES Todos Exc. Kit de Levantamiento	
R	72-80	PICKUP 1/2 TON, W100 SERIES Todos	
R	81-93	PICKUP 1 TON, W300 SERIES Todos Exc. Suspensión Quad y Kit de Levantamiento	
R	72-80	PICKUP 1 TON, W300 SERIES Todos	
R	90-93	PICKUP 3/4 TON, W200 SERIES Extended Cab Pickup Exc. Kit de Levantamiento	
R	88-93	PICKUP 3/4 TON, W200 SERIES Cab & Chassis Exc. Kit de Levantamiento	
R	81-93	PICKUP 3/4 TON, W200 SERIES Standard Cab Pickup Exc. Kit de Levantamiento	
R	86	PICKUP 3/4 TON, W200 SERIES Cab & Chassis Exc. Kit de Levantamiento	
R	81-83	PICKUP 3/4 TON, W200 SERIES Cab & Chassis Exc. Kit de Levantamiento	
R	81-82	PICKUP 3/4 TON, W200 SERIES Extended Cab Pickup Exc. Kit de Levantamiento	
R	72-80	PICKUP 3/4 TON, W200 SERIES Todos	
R	76-81	PLYMOUTH TRAILDUSTER 4x4	
77403	D		
R	79-95	CHEVROLET VAN 1 TON, G / EXPRESS Todos PBV 9200	
F	85	VAN 1 TON, P SERIES Todos Chasis Motorhome c/ Eje de Vega Delantero en I	
R	97-04	DODGE DAKOTA Todos	
R	98-03	DURANGO Todos	
R	79-95	GMC VAN 1 TON, G / SAVANNA Cutaway Van PBV 9200	

Lista numérica

Amort.	POP	No. Alternativo	Montaje Accesorio
Pos.	Año	Aplicación	
77403	D	-continued	
F	85	VAN 1 TON, P SERIES Todos Chasis Motorhome c/ Eje de Vega Delantero en I	
77405	W		140884
F	55-56	CHEVROLET PICKUP 3200	
F	55-56	PICKUP 3800	
F	55	PICKUP 3100	
R	55	FORD F SERIES Todos F-100	
F	48-52	F SERIES Todos F-1, F-2 y F-3	
F	68-76	PICKUP P350 Todos Hasta PBV 8000#	
F	75-76	PICKUP P400 Todos Hasta PBV 8000#	
R	68	INTERNATIONAL 908C Todos	
R	68	1000C Todos Exc. Travelette c/ base de rueda de 166"	
F	68	1100C Todos Exc. Travelette c/ base de rueda de 166"	
R	68	1100C Todos Exc. Travelette c/ base de rueda de 166"	
F	68	1200C Todos Exc. Travelette c/ base de rueda de 166"	
R	68	1200C Todos Exc. Travelette c/ base de rueda de 166"	
F	68	1300C Todos Exc. Travelette c/ base de rueda de 166"	
R	68	1300C Todos Exc. Travelette c/ base de rueda de 166"	
R	68-72	M1100 / M1200 Todos	
R	69	M1400 Todos	
R	66-83	JEEP CJ5 Todos Exc. Kit de Levantamiento	
R	66-75	CJ6 Todos Exc. Kit de Levantamiento	
R	76-86	CJ7 Todos Exc. Kit de Levantamiento	
R	66-74	DJ5 Todos Exc. Kit de Levantamiento	
R	66-68	DJ6 Todos Exc. Kit de Levantamiento	
R	57-60	FC150 Todos	
F	63-65	FC170 Todos	
R	63-65	FC170 Todos	
R	63-66	GLADIATOR Todos Suspensión Delantera Independiente	
R	70-73	JEEP STER Todos	
R	81-85	SCRAMBLER / CJ8 Todos	
R	66-67	UNIVERSAL Todos Exc. Kit de Levantamiento	
R	61-65	UNIVERSAL Todos	
77406	W		
R	85-96	FORD PICKUP 1/2 TON, F-150 4x2 Tracción trasera	
R	80-97	PICKUP 1 TON, F-350 / SUPERDUTY 4x2 Tracción trasera Exc. Doble Rodada Trasera	
R	97	PICKUP 3/4 TON, F-250 / SUPERDUTY 4x2 Tracción trasera PBV arriba de 8500#	
R	80-96	PICKUP 3/4 TON, F-250 / SUPERDUTY 4x2 Tracción trasera	
77409	W		
R	80-96	FORD BRONCO Todos Exc. Kit de Levantamiento	
R	80-83	PICKUP 1/2 TON, F-100 4x2 Tracción trasera	
R	80-84	PICKUP 1/2 TON, F-150 4x2 Tracción trasera	
R	90-97	PICKUP 1/2 TON, F SUPERDUTY Todos	
R	80-97	PICKUP 1 TON, F-350 / SUPERDUTY 4x2 Tracción trasera Doble Rodada Trasera	
R	97	PICKUP, F-450 SUPERDUTY Todos	
77410	W		141047
F	80-96	FORD BRONCO Todos Suspensión Quad adelante del Eje Delantero; Exc. Kit de Levantamiento	
F	80-96	PICKUP 1/2 TON, F-150 4x4 Suspensión Quad adelante del Eje Delantero; Exc. Kit de Levantamiento	
F	80-81	PICKUP 1 TON, F-350 / SUPERDUTY 4x4	
F	80-82	PICKUP 3/4 TON, F-250 / SUPERDUTY 4x4	
77412	D		
R	03-07	CHEVROLET CHEYENNE	

Lista numérica

Amort.	POP	No. Alternativo	Montaje Accesorio
Pos.	Año	Aplicación	
77412	D	-continued	
R	99-06	PICKUP 1/2 TON, SILVERADO 1500 4x4 Estilo Carrocería Clásica y Antigua, Exc. Suspensión Electrónica Ajustable	
R	05-06	PICKUP 1/2 TON, SILVERADO 1500 HD Todos	
R	01-03	PICKUP 1/2 TON, SILVERADO 1500 HD Todos	
R	77-86	PICKUP 1 TON, K30 Todos	
R	90-91	PICKUP 1 TON, R3500 Todos	
R	89	PICKUP 1 TON, R3500 Cab & Chassis, 4x2 Tracción trasera	
R	89	PICKUP 1 TON, R3500 Crew Cab Pickup, 4x2 Tracción trasera	
R	01-09	PICKUP 1 TON, SILVERADO 3500 Todos	
R	07-10	PICKUP 1 TON, SILVERADO 3500 HD Todos	
R	87-88	PICKUP 1 TON, V30 Todos	
R	89-91	PICKUP 1 TON, V3000 / V3500 Todos	
R	99-08	PICKUP 3/4 TON, SILVERADO 2500 Todos	
R	01-10	PICKUP 3/4 TON, SILVERADO 2500 HD Todos	
R	07	SILVERADO 1500 CLASSIC 4x4 Exc. Suspensión Electrónica Ajustable	
R	06-07	DODGE PICKUP 1/2 TON, RAM 1500 Todos Exc. Mega Cab	
R	02-05	PICKUP 1/2 TON, RAM 1500 Todos	
R	77-86	GMC PICKUP 1 TON, K35 / K3500 Todos	
R	87-91	PICKUP 1 TON, V3000 / V3500 Todos	
R	99-06	SIERRA 1500 4x4 Estilo Carrocería Clásica y Antigua, Exc. Suspensión Electrónica Ajustable	
R	07	SIERRA 1500 CLASSIC 4x4 Exc. Suspensión Electrónica Ajustable	
R	05-06	SIERRA 1500 HD Todos	
R	01-03	SIERRA 1500 HD Todos	
R	99-04	SIERRA 2500 Todos	
R	01-10	SIERRA 2500 HD Todos	
R	01-06	SIERRA 3500 Todos	
R	07-10	SIERRA 3500 HD Todos	
77413	W		
R	78-95	CHEVROLET VAN 1/2 TON, G / EXPRESS Todos	
R	85-91	VAN 1 TON, G / EXPRESS Extended Cargo Van	
R	85-91	VAN 1 TON, G / EXPRESS Extended Passenger Van	
R	78-91	VAN 1 TON, G / EXPRESS Standard Cargo Van	
R	78-91	VAN 1 TON, G / EXPRESS Standard Passenger Van	
R	78-95	VAN 3/4 TON, G / EXPRESS Todos Exc. PBV 8600 #	
R	84-86	DODGE MINI RAM Todos	
R	99-03	VAN 1/2 TON, A / B SERIES / RAM 109.3 (WheelBase) Exc. PBV 7000#	
R	81-98	VAN 1/2 TON, A / B SERIES / RAM 109.6 (WheelBase) Exc. PBV 7000#	
R	71-80	VAN 1/2 TON, A / B SERIES / RAM Todos	
R	99-03	VAN 1 TON, A / B SERIES / RAM Todos	
R	94-98	VAN 1 TON, A / B SERIES / RAM Todos Exc. Eje Delantero 4000#	
R	71-93	VAN 1 TON, A / B SERIES / RAM Todos	
R	71-03	VAN 3/4 TON, A / B SERIES / RAM Todos	
R	74-80	VAN, CB300 Todos PBV arriba de 8300#	
R	78-95	GMC VAN 1/2 TON, G / SAVANNA Todos	
R	78-95	VAN 3/4 TON, G / SAVANNA Todos Exc. PBV 8600 #	
R	74-83	PLYMOUTH VAN 1/2 TON, PB SERIES Todos	
R	74-83	VAN 1 TON, PB SERIES Todos	
R	74-83	VAN 3/4 TON, PB SERIES Todos	
77414	W	140780	
F	80-96	FORD BRONCO Todos Con o sin Suspensión Quad detrás del Eje Delantero; Exc. Kit de Levantamiento	
F	89	BRONCO II Todos Fab. desde 2/89; Vehículos con perno de 12mm en montaje inferior trasero	

Amortiguador Monotubo MaxControl

Amort.	POP	No. Alternativo	Montaje Accesorio
Pos.	Año	Aplicación	
77414	W	-continued 140780	
F	84-88	BRONCO II Todos Con Perno de 10mm en Montaje Inferior Trasero	
F	80-83	PICKUP 1/2 TON, F-100 4x2 Tracción trasera	
F	80-96	PICKUP 1/2 TON, F-150 4x4 Con o sin Suspensión Quad detrás del Eje Delantero; Exc. Kit de Levantamiento	
F	80-96	PICKUP 1/2 TON, F-150 4x2 Tracción trasera	
F	80-97	PICKUP 1 TON, F-350 / SUPERDUTY 4x2 Tracción trasera	
F	97	PICKUP 3/4 TON, F-250 / SUPERDUTY 4x2 Tracción trasera PBV arriba de 8500#	
F	80-96	PICKUP 3/4 TON, F-250 / SUPERDUTY 4x2 Tracción trasera	
F	87-89	RANGER Todos Exc. Opción High Ryder	
F	83-86	RANGER Todos	
77418	W	141356	
F	82	DODGE D50 4x4	
F	87-93	PICKUP, RAM 50 4x4	
F	87-89	RAIDER Todos	
F	95-96	MITSUBISHI MIGHTY MAX 4x2 Tracción trasera	
F	83-94	MIGHTY MAX 4x4	
F	83-91	MONTERO Todos	
77421	W	140455	
F	05	CHEVROLET BLAZER Base, 4x2 Tracción trasera	
F	96-04	BLAZER LS, 4x2 Tracción trasera	
F	95-02	BLAZER LT, 4x2 Tracción trasera	
F	95-99	BLAZER Base, 4x2 Tracción trasera	
F	95-97	BLAZER Deluxe, 4x2 Tracción trasera	
F	83-94	BLAZER, S MODELS 4x2 Tracción trasera	
F	94-03	S10 LS, 4x2 Tracción trasera	
F	82-03	S10 Base, 4x2 Tracción trasera	
F	92-93	S10 EL, 4x2 Tracción trasera	
F	83-92	S10 Tahoe, 4x2 Tracción trasera	
F	88-90	S10 Durango, 4x2 Tracción trasera	
F	82-86	S10 Durango, 4x2 Tracción trasera	
F	72-82	FORD COURIER Todos	
F	92-04	GMC JIMMY 4x2 Tracción trasera	
F	83-91	S15 JIMMY 4x2 Tracción trasera	
F	04	SONOMA / S15 Todos 4x2 Tracción trasera	
F	82-03	SONOMA / S15 4x2 Tracción trasera	
F	78-87	SPRINT / CABALLERO 4x2 Tracción trasera	
F	71-77	SPRINT / CABALLERO Todos	
F	96-00	ISUZU HOMBRE 4x2 Tracción trasera Exc. Chasis Deportivo	
F	72-76	MAZDA B1600 Todos	
F	77-78	B1800 Todos	
F	79-84	B2000 Todos	
F	82-84	B2200 Todos	
77422	W		
R	05	CHEVROLET BLAZER Base, 4x4	
R	05	BLAZER Base, 4x2 Tracción trasera	
R	96-04	BLAZER LS, 4x4	
R	96-04	BLAZER LS, 4x2 Tracción trasera	
R	95-02	BLAZER LT, 4x2 Tracción trasera	
R	95-01	BLAZER LT, 4x4	
R	95-99	BLAZER Base, 4x4	
R	95-99	BLAZER Base, 4x2 Tracción trasera	
R	95-97	BLAZER Deluxe, 4x2 Tracción trasera	
R	83-94	BLAZER, S MODELS Todos	
R	99-04	S10 LS, 4x4	
R	99-03	S10 Base, 4x4	
R	99-03	S10 Base, 4x2 Tracción trasera	
R	99-03	S10 LS, 4x2 Tracción trasera	
R	94-98	S10 LS	
R	82-98	S10 Base	
R	92-93	S10 EL	
R	83-92	S10 Tahoe	
R	88-90	S10 Durango	
R	82-86	S10 Durango	
R	92-05	GMC JIMMY Todos	
R	83-91	S15 JIMMY Todos	
R	82-04	SONOMA / S15 Todos	
R	91	SYCLONE Todos	
R	92-93	TYPHOON Todos	
R	98-00	ISUZU HOMBRE Todos	
R	96-97	HOMBRE 4x2 Tracción trasera	
R	96-01	OLDSMOBILE BRAVADA Todos	
R	91-94	BRAVADA Todos	

Lista numérica

Amort.	POP	No. Alternativo	Montaje Accesorio
Pos.	Año	Aplicación	
77423	W		
F	05	CHEVROLET BLAZER Base, 4x4 Exc. ZR2	
F	00-04	BLAZER LS, 4x4 Exc. ZR2	
F	95-01	BLAZER LT, 4x4 Exc. ZR2	
F	95-99	BLAZER Base, 4x4 Exc. ZR2	
F	99	BLAZER LS, 4x4	
F	96-98	BLAZER LS, 4x4 Exc. ZR2	
F	83-94	BLAZER, S MODELS 4x4	
F	94-04	S10 LS, 4x4 Exc. ZR2, ZR5 or Sport Chassis	
F	92-03	S10 Base, 4x4 Exc. ZR2, ZR5 or Sport Chassis	
F	92-93	S10 EL, 4x4 Exc. ZR2, ZR5 or Sport Chassis	
F	83-92	S10 Tahoe, 4x4 Exc. ZR2, ZR5 or Sport Chassis	
F	91	S10 Base, 4x4	
F	88-90	S10 Durango, 4x4 Exc. ZR2, ZR5 or Sport Chassis	
F	83-90	S10 Base, 4x4 Exc. ZR2, ZR5 or Sport Chassis	
F	83-86	S10 Durango, 4x4 Exc. ZR2, ZR5 or Sport Chassis	
F	92-05	GMC JIMMY 4x4	
F	83-91	S15 JIMMY 4x4	
F	83-04	SONOMA / S15 4x4	
F	91	SYCLONE Todos	
F	92-93	TYPHOON Todos	
F	99-00	ISUZU HOMBRE 4x4	
F	96-98	HOMBRE 4x2 Tracción trasera Chasis Deportivo	
F	98	HOMBRE 4x4 Chasis Deportivo	
F	96-01	OLDSMOBILE BRAVADA Todos	
F	91-94	BRAVADA Todos	
77424	D	141353	
F	84-01	JEEP CHEROKEE Todos	
F	86-92	COMANCHE Todos	
F	93-98	GRAND CHEROKEE Todos	
F	84	GRAND WAGONEER Todos Exc. Suspensión Up Country	
F	84-90	WAGONEER Todos	
77425	W		
R	84-01	JEEP CHEROKEE Todos	
R	84-90	WAGONEER Todos	
77454	D		
R	90-05	CHEVROLET ASTRO Todos	
R	85-89	ASTRO 4x2 Tracción trasera	
R	90-05	GMC SAFARI Todos	
R	85-89	SAFARI 4x2 Tracción trasera	
77455	W		
F	86-97	FORD PICKUP 1 TON, F-350 / SUPERDUTY 4x4	
F	97-98	PICKUP 3/4 TON, F-250 / SUPERDUTY 4x4 PBV arriba de 8500#	
F	87-96	PICKUP 3/4 TON, F-250 / SUPERDUTY 4x4	
77456	W		
R	86-97	FORD PICKUP 1 TON, F-350 / SUPERDUTY 4x4 Exc. Doble Rodada Trasera	
77461	W		
R	80-96	FORD PICKUP 1/2 TON, F-150 4x4 Exc. Kit de Levantamiento	
R	86-97	PICKUP 1 TON, F-350 / SUPERDUTY 4x4 Doble Rodada Trasera	
R	82-85	PICKUP 1 TON, F-350 / SUPERDUTY 4x4 Montaje Inferior Delantero Tipo Abrazadera Exc. Doble Rodado o Kit de Levantamiento	
R	80-81	PICKUP 1 TON, F-350 / SUPERDUTY 4x4	
R	97	PICKUP 3/4 TON, F-250 / SUPERDUTY 4x4 PBV arriba de 8500#	
R	86-96	PICKUP 3/4 TON, F-250 / SUPERDUTY 4x4	
R	82-85	PICKUP 3/4 TON, F-250 / SUPERDUTY 4x4 Montaje Inferior Delantero Tipo Abrazadera Exc. Doble Rodado o Kit de Levantamiento	
R	80-81	PICKUP 3/4 TON, F-250 / SUPERDUTY 4x4	
R	99-04	PICKUP, F-450 SUPERDUTY Todos	
R	99-04	PICKUP, F-550 SUPERDUTY Todos	

Lista numérica

Amort.	POP	No. Alternativo	Montaje Accesorio
Pos.	Año	Aplicación	
77479	W		140524
F	86-95	TOYOTA 4RUNNER Todos	
F	86-95	PICKUP 4x4 Exc. Kit de Levantamiento	
F	93-98	T100 4x4	
77488	D		
R	88-99	CHEVROLET PICKUP 1/2 TON, C15 / C1500 Todos	
R	88-99	PICKUP 1/2 TON, K15 / K1500 Todos	
R	01-03	PICKUP 1 TON, C35/3500 Base	
R	91-00	PICKUP 1 TON, C35/3500 Todos	
R	88-90	PICKUP 1 TON, C35/3500 Standard Cab Pickup Eje Delantero Rígido HD	
R	88-90	PICKUP 1 TON, C35/3500 Extended Cab Pickup Eje Delantero Rígido HD	
R	88-00	PICKUP 1 TON, K35 / K3500 Todos	
R	88-00	PICKUP 3/4 TON, C25 / C2500 Todos	
R	88-00	PICKUP 3/4 TON, K25 / K2500 Todos	
R	01-02	GMC C3500	
R	88-99	PICKUP 1/2 TON, C15 / C1500 Todos	
R	88-99	PICKUP 1/2 TON, K15 / K1500 Todos	
R	91-00	PICKUP 1 TON, C35/3500 Todos	
R	88-90	PICKUP 1 TON, C35/3500 Extended Cab Pickup Eje Delantero Rígido HD	
R	88-90	PICKUP 1 TON, C35/3500 Standard Cab Pickup Eje Delantero Rígido HD	
R	88-00	PICKUP 1 TON, K35 / K3500 Todos	
R	88-00	PICKUP 3/4 TON, C25 / C2500 Todos	
R	88-00	PICKUP 3/4 TON, K25 / K2500 Todos	
77489	D		
F	88-99	CHEVROLET PICKUP 1/2 TON, C15 / C1500 Todos	
F	01-03	PICKUP 1 TON, C35/3500 Base Eje Delantero Rígido HD	
F	98-00	PICKUP 1 TON, C35/3500 Todos Eje Delantero Rígido HD	
F	92-97	PICKUP 1 TON, C35/3500 Crew Cab Pickup Eje Delantero Rígido HD	
F	88-97	PICKUP 1 TON, C35/3500 Extended Cab Pickup Eje Delantero Rígido HD	
F	88-97	PICKUP 1 TON, C35/3500 Standard Cab Pickup Eje Delantero Rígido HD	
F	88-00	PICKUP 3/4 TON, C25 / C2500 Todos	
F	92-99	SUBURBAN 1/2 TON, C15 / C1500 Todos	
F	92-99	SUBURBAN 3/4 TON, C25 / C2500 Todos	
F	95-00	TAHOE 4x2 Tracción trasera Old Body Style	
F	88-99	GMC PICKUP 1/2 TON, C15 / C1500 Todos	
F	88-00	PICKUP 1 TON, C35/3500 Extended Cab Pickup Eje Delantero Rígido HD	
F	88-00	PICKUP 1 TON, C35/3500 Standard Cab Pickup Eje Delantero Rígido HD	
F	88-00	PICKUP 3/4 TON, C25 / C2500 Todos	
F	92-99	SUBURBAN 1/2 TON, C15 / C1500 Todos	
F	92-99	SUBURBAN 3/4 TON, C25 / C2500 Todos	
F	92-99	YUKON 4x2 Tracción trasera	
77492	W		141137
R	81-82	CHEVROLET LUV PICKUP Todos	
R	87-89	DODGE RAIDER 2.6L 4Cyl L (156) Exc. Sport Utility	
F	61-67	FORD ECONOLINE Todos	
R	81-95	ISUZU PICKUP Todos	
R	86-92	JEEP COMANCHE Todos	
F	66-73	WAGONEER Todos	
F	63-65	WAGONEER Todos Exc. Suspensión Independiente Delantera	
R	83-89	MITSUBISHI MONTERO 2.6L 4Cyl L (156)	
R	89	MONTERO 3.0L 6Cyl V (181)	
R	97-99	MONTERO SPORT Todos	
R	82-86	NISSAN 720 PICKUP 4x4	
R	00-04	FRONTIER Crew Cab Pickup, 4x2 Tracción trasera con Desert Runner	
R	98-04	FRONTIER 4x4	
R	98-99	FRONTIER 4x2 Tracción trasera Crew Cab con Desert Runner	
R	87-95	PATHFINDER Todos Exc. Suspensión Electrónica Ajustable	

Amortiguador Monotubo MaxControl

Amort.	POP	No. Alternativo	Montaje Accesorio
Pos.	Año	Aplicación	
77492	W	-continued	141137
R	65-94	PICKUP	
R	00-04	XTERRA Todos	
R	84-87	TOYOTA LAND CRUISER FJ60 (Código plataforma del fabricante), Sport Utility	
R	76-83	LAND CRUISER Todos	
R	75	LAND CRUISER Todos Fab. hasta 2/75	
R	69-74	LAND CRUISER Todos	
R	85-92	PICKUP 4x2 Tracción trasera 1 Ton	
R	80-83	PICKUP 4x4 Exc. Kit de Levantamiento	
R	93-98	T100 4x2 Tracción trasera	
77494	D		140149
R	84-89	TOYOTA 4RUNNER Todos	
R	84-95	PICKUP 4x4 Exc. Kit de Levantamiento	
R	98-04	TACOMA Pre Runner	
R	95-04	TACOMA 4x4	
77524	D		
R	12	FORD RANGER Todos 4x4	
R	12	RANGER 4x2 Tracción trasera, Torsion (FrontSpringType)	
R	06-11	RANGER 4x2 Tracción trasera, Barra de Torsion (FrontSpringType)	
R	90-11	RANGER 4x4	
R	01-05	RANGER Edge, 4x2 Tracción trasera	
R	89	RANGER 4x4 Fab. desde 2/89; Vehículos con perno de 12mm en montaje inferior trasero	
R	95-96	MAZDA B2300 4x4	
R	03-06	B3000 Todos 4x4	
R	98-02	B3000 4x4	
R	98-06	B4000 4x4	
77525	W		
R	90	FORD BRONCO II Todos	
R	89	BRONCO II Todos Fab. desde 2/89; Vehículos con perno de 12mm en montaje inferior trasero	
R	12	RANGER Todos Coil (FrontSpringType)	
R	06-11	RANGER 4x2 Tracción trasera, Coil (FrontSpringType)	
R	98-05	RANGER XL, 4x2 Tracción trasera	
R	98-05	RANGER XLT, 4x2 Tracción trasera	
R	05	RANGER STX, 4x2 Tracción trasera	
R	04	RANGER Tremor, 4x2 Tracción trasera	
R	90-97	RANGER 4x2 Tracción trasera	
R	89	RANGER 4x2 Tracción trasera Fab. desde 2/89; Vehículos con perno de 12mm en montaje inferior trasero	
R	01-06	MAZDA B2300 4x2 Tracción trasera	
R	94-97	B2300 4x2 Tracción trasera	
R	98-01	B2500 4x2 Tracción trasera	
R	94-06	B3000 4x2 Tracción trasera	
R	94-06	B4000 4x2 Tracción trasera	
77607	W		140719
R	00-05	FORD EXCURSION 4x2 Tracción trasera	
R	91-94	EXPLORER Todos	
R	91-94	MAZDA NAVAJO Todos	
77608	W		140780
F	91-94	FORD EXPLORER Todos	
F	92-11	VAN 1/2 TON, ECONOLINE / CLUB WAGON Todos	
F	91-94	MAZDA NAVAJO Todos	
77609	W		
F	99-00	CADILLAC ESCALADE Todos	
F	90-05	CHEVROLET ASTRO AWD	
F	92-94	BLAZER 4x4 Automóvil Grande	
F	88-99	PICKUP 1/2 TON, K15 / K1500 Todos	
F	88-00	PICKUP 1 TON, K35 / K3500 Todos	
F	88-00	PICKUP 3/4 TON, K25 / K2500 Todos	
F	92-99	SUBURBAN 1/2 TON, K15 / K1500 Todos	
F	92-99	SUBURBAN 3/4 TON, K25 / K2500 Todos	
F	95-00	TAHOE 4x4 Old Body Style	
F	88-99	GMC PICKUP 1/2 TON, K15 / K1500 Todos	
F	88-00	PICKUP 1 TON, K35 / K3500 Todos	
F	88-00	PICKUP 3/4 TON, K25 / K2500 Todos	
F	90-05	SAFARI AWD	

Lista numérica

Amort.	POP	No. Alternativo	Montaje Accesorio
Pos.	Año	Aplicación	
77609	W	-continued	
F	92-99	SUBURBAN 1/2 TON, K15 / K1500 Todos	
F	92-99	SUBURBAN 3/4 TON, K25 / K2500 Todos	
F	92-99	YUKON 4x4	
F	99	YUKON Denali	
77614	D		140780
F	90	FORD BRONCO II Todos	
F	00-05	EXCURSION 4x2 Tracción trasera	
F	90-97	RANGER Todos	
F	07-14	VAN 1 TON, ECONOLINE / CLUB WAGON / SUPERDUTY Todos Exc. Cutaway Chassis	
F	07-14	VAN 1 TON, ECONOLINE / CLUB WAGON / SUPERDUTY Todos Exc. Paquete de Ambulancia y Manejo	
F	01-14	VAN 1 TON, ECONOLINE / CLUB WAGON / SUPERDUTY Todos	
F	92-05	VAN 1 TON, ECONOLINE / CLUB WAGON / SUPERDUTY Todos Conversión a Motorhome	
F	92-05	VAN 1 TON, ECONOLINE / CLUB WAGON / SUPERDUTY Todos Cutaway Chassis	
F	92-14	VAN 3/4 TON, ECONOLINE / CLUB WAGON / SUPERDUTY Todos	
F	94-97	MAZDA B2300 Todos	
F	94-97	B3000 4x2 Tracción trasera	
F	94-97	B4000 4x2 Tracción trasera	
77623	W		142731
R	10-14	FORD VAN 1/2 TON, ECONOLINE / CLUB WAGON Todos	
R	11-14	VAN 1 TON, ECONOLINE / CLUB WAGON / SUPERDUTY Todos	
R	03-14	VAN 1 TON, ECONOLINE / CLUB WAGON / SUPERDUTY Todos Exc. Cutaway Chassis	
R	03-11	VAN 1 TON, ECONOLINE / CLUB WAGON / SUPERDUTY Todos Exc. Paquete de Ambulancia y Manejo	
R	07-08	VAN 1 TON, ECONOLINE / CLUB WAGON / SUPERDUTY Todos	
R	92-05	VAN 1 TON, ECONOLINE / CLUB WAGON / SUPERDUTY Todos Conversión a Motorhome	
R	92-05	VAN 1 TON, ECONOLINE / CLUB WAGON / SUPERDUTY Todos Cutaway Chassis	
R	01-03	VAN 1 TON, ECONOLINE / CLUB WAGON / SUPERDUTY Todos	
R	92-14	VAN 3/4 TON, ECONOLINE / CLUB WAGON / SUPERDUTY Todos	
77638	D		
R	99-00	CADILLAC ESCALADE Todos	
R	92-94	CHEVROLET BLAZER 4x4 Automóvil Grande	
R	92-94	BLAZER 4x4 Full Size	
R	92-99	SUBURBAN 1/2 TON, C15 / C1500 Todos	
R	92-99	SUBURBAN 1/2 TON, K15 / K1500 Todos	
R	92-99	SUBURBAN 3/4 TON, C25 / C2500 Todos	
R	92-99	SUBURBAN 3/4 TON, K25 / K2500 Todos	
R	95-00	TAHOE Todos Old Body Style	
R	96-14	VAN 1/2 TON, G / EXPRESS Todos	
R	96-16	VAN 1 TON, G / EXPRESS Todos	
R	03-16	VAN 3/4 TON, G / EXPRESS Todos	
R	96-02	VAN 3/4 TON, G / EXPRESS Todos Exc. 8600# GVW	
R	96-02	VAN 3/4 TON, G / EXPRESS Todos Exc. PBV 8600 #	
R	92-99	GMC SUBURBAN 1/2 TON, C15 / C1500 Todos	
R	92-99	SUBURBAN 1/2 TON, K15 / K1500 Todos	
R	92-99	SUBURBAN 3/4 TON, C25 / C2500 Todos	
R	92-99	SUBURBAN 3/4 TON, K25 / K2500 Todos	
R	96-14	VAN 1/2 TON, G / SAVANNA 4x2 Tracción trasera	
R	04-16	VAN 1 TON, G / SAVANNA Todos	
R	96-02	VAN 1 TON, G / SAVANNA Todos Exc. 8600# GVW	
R	96-02	VAN 1 TON, G / SAVANNA Todos Exc. PBV 8600 #	
R	96	VAN 1 TON, G / SAVANNA Todos 7100, 7400 and 8600# GVW	

Lista numérica

Amort.	POP	No. Alternativo	Montaje Accesorio
Pos.	Año	Aplicación	
77638	D	-continued	
R 96	VAN 1 TON, G / SAVANNA Todos 7100, 7400, y 8600# PBV		
R 03-16	VAN 3/4 TON, G / SAVANNA Todos		
R 96-02	VAN 3/4 TON, G / SAVANNA Todos Exc. 8600# GVW		
R 96-02	VAN 3/4 TON, G / SAVANNA Todos Exc. PBV 8600 #		
R 92-99	YUKON Todos		
R 99	YUKON Denali		
77661	W		
F 94-01	DODGE PICKUP 1/2 TON, RAM 1500 4x2 Tracción trasera		
F 94-02	PICKUP 1 TON, RAM 3500 4x2 Tracción trasera Exc. Eje Delantero Rígido		
F 94-02	PICKUP 3/4 TON, RAM 2500 4x2 Tracción trasera		
77662	D		
R 03-07	CHEVROLET CHEYENNE		
R 99-06	PICKUP 1/2 TON, SILVERADO 1500 4x2 Tracción trasera Exc. Suspensión Electrónica Ajustable		
R 07	SILVERADO 1500 CLASSIC 4x2 Tracción trasera Exc. Suspensión Electrónica Ajustable		
R 74-80	VAN 1/2 TON, P SERIES Todos		
R 79-89	VAN 3/4 TON, P SERIES Todos		
R 94-01	DODGE PICKUP 1/2 TON, RAM 1500 Todos		
R 94-02	PICKUP 1 TON, RAM 3500 4x2 Tracción trasera Exc. Eje Delantero Rígido		
R 94-02	PICKUP 3/4 TON, RAM 2500 4x4, GAS Exc. PBV 8600 #		
R 94-02	PICKUP 3/4 TON, RAM 2500 4x2 Tracción trasera		
R 95-96	PICKUP 3/4 TON, RAM 2500 4x4, CNG Exc. PBV 8600 #		
R 99-06	GMC SIERRA 1500 4x2 Tracción trasera Exc. Suspensión Electrónica Ajustable		
R 07	SIERRA 1500 CLASSIC 4x2 Tracción trasera Exc. Suspensión Electrónica Ajustable		
R 74-80	VAN 1/2 TON, P SERIES Todos		
R 75-99	VAN 1 TON, P SERIES Todos		
R 73-74	VAN 1 TON, P SERIES Base Exc. Chasis Motorhome		
77673	W		142731
F 94-01	DODGE PICKUP 1/2 TON, RAM 1500 4x4		
F 94-02	PICKUP 3/4 TON, RAM 2500 4x4, GAS Exc. PBV 8600 #		
77674	D		142731
F 94-02	DODGE PICKUP 1 TON, RAM 3500 4x4		
F 94-02	PICKUP 1 TON, RAM 3500 4x2 Tracción trasera Eje Delantero Rígido		
F 94-02	PICKUP 3/4 TON, RAM 2500 4x4, DIESEL PBV 8800		
77675	D		
R 94-02	DODGE PICKUP 1 TON, RAM 3500 4x4		
R 94-02	PICKUP 1 TON, RAM 3500 4x2 Tracción trasera Eje Delantero Rígido		
R 94-02	PICKUP 3/4 TON, RAM 2500 4x4, DIESEL PBV 8800		
77678	D		
F 95-01	FORD EXPLORER Todos Exc. Suspensión de Aire		
F 01-05	EXPLORER SPORT TRAC Todos		
F 12	RANGER Todos		
F 12	RANGER 4x2 Tracción trasera, Torsion (FrontSpringType)		
F 06-11	RANGER 4x2 Tracción trasera, Barra de Torsion (FrontSpringType)		
F 98-11	RANGER 4x4		
F 01-05	RANGER Edge, 4x2 Tracción trasera		
F 03-06	MAZDA B3000 Todos 4x4		
F 98-02	B3000 4x4		
F 98-06	B4000 4x4		
F 97-01	MERCURY MOUNTAINEER Todos Exc. Suspensión Electrónica Ajustable		

Amortiguador Monotubo MaxControl

Amort.	POP	No. Alternativo	Montaje Accesorio
Pos.	Año	Aplicación	
77679	W		140719
R 95-01	FORD EXPLORER Todos Exc. Suspensión de Aire		
R 01-05	EXPLORER SPORT TRAC Todos		
R 97-01	MERCURY MOUNTAINEER Todos Exc. Suspensión Electrónica Ajustable		
77683	W		
R 93-98	JEEP GRAND CHEROKEE Todos		
77714	D		142731
F 97-02	FORD EXPEDITION 4x2 Tracción trasera Exc. Nivelación Nuemática Delantera		
F 97-04	LOBO PICK UP		
F 97-04	PICKUP 1/2 TON, F-150 4x2 Tracción trasera		
F 96-99	PICKUP 3/4 TON, F-250 / SUPERDUTY 4x2 Tracción trasera Hasta PBV 8500#		
F 98-02	LINCOLN NAVIGATOR 4x2 Tracción trasera		
77715	W		142700
R 97-04	FORD LOBO PICK UP		
R 97-04	PICKUP 1/2 TON, F-150 4x4 Exc. PBV 7700#		
R 97-99	PICKUP 3/4 TON, F-250 / SUPERDUTY 4x4 Hasta PBV 8500#, Exc. Superduty		
77716	W		142731
F 97-02	FORD EXPEDITION 4x4 Exc. Nivelación Nuemática Delantera		
F 97-04	LOBO PICK UP		
F 04	PICKUP 1/2 TON, F-150 4x4 Exc. PBV 7700#		
F 97-03	PICKUP 1/2 TON, F-150 4x4		
F 97-99	PICKUP 3/4 TON, F-250 / SUPERDUTY 4x4 Hasta PBV 8500#, Exc. Superduty		
77717	D		
R 97-02	FORD EXPEDITION Todos		
R 98-02	LINCOLN NAVIGATOR 4x2 Tracción trasera		
77726	W		140921
R 90-02	TOYOTA 4RUNNER Todos		
77772	D		140780
F 12	FORD RANGER Todos Coil (FrontSpringType)		
F 06-11	RANGER 4x2 Tracción trasera, Coil (FrontSpringType)		
F 01-05	RANGER XL, 4x2 Tracción trasera, Coil (FrontSpringType)		
F 01-05	RANGER XLT, 4x2 Tracción trasera, Coil (FrontSpringType)		
F 98-00	RANGER XL, 4x2 Tracción trasera		
F 98-00	RANGER XLT, 4x2 Tracción trasera		
F 01-06	MAZDA B2300 4x2 Tracción trasera		
F 98-01	B2500 4x2 Tracción trasera		
F 98-06	B3000 4x2 Tracción trasera		
F 98-06	B4000 4x2 Tracción trasera		
77778	D		142700
R 97-04	FORD LOBO PICK UP		
R 04	PICKUP 1/2 TON, F-150 4x2 Tracción trasera		
R 00-03	PICKUP 1/2 TON, F-150 Harley-Davidson Edition, 4x2 Tracción trasera		
R 99-03	PICKUP 1/2 TON, F-150 Lariat, 4x2 Tracción trasera		
R 99-03	PICKUP 1/2 TON, F-150 XL, 4x2 Tracción trasera		
R 99-03	PICKUP 1/2 TON, F-150 XLT, 4x2 Tracción trasera		
R 00	PICKUP 1/2 TON, F-150 Base, 4x2 Tracción trasera		
R 97-98	PICKUP 1/2 TON, F-150 4x2 Tracción trasera		
R 97-99	PICKUP 3/4 TON, F-250 / SUPERDUTY 4x2 Tracción trasera Hasta PBV 8500#		
77781	W		141350
R 92-00	MITSUBISHI MONTERO Todos		
77782	W		141350
F 92-00	MITSUBISHI MONTERO Todos		
F 97-99	MONTERO SPORT Todos		
77783	D		141665
F 03-07	CHEVROLET CHEYENNE		

Lista numérica

Amort.	POP	No. Alternativo	Montaje Accesorio
Pos.	Año	Aplicación	
77783	D	-continued	
F 99-06	PICKUP 1/2 TON, SILVERADO 1500 4x2 Tracción trasera Exc. Suspensión Electrónica Ajustable		141665
F 99-04	PICKUP 3/4 TON, SILVERADO 2500 4x2 Tracción trasera PBV 8600 Lb.; Exc. Suspensión Quadrasteer		
F 07	SILVERADO 1500 CLASSIC 4x2 Tracción trasera Exc. Suspensión Electrónica Ajustable		
F 99-06	GMC SIERRA 1500 4x2 Tracción trasera Exc. Suspensión Electrónica Ajustable		
F 07	SIERRA 1500 CLASSIC 4x2 Tracción trasera Exc. Suspensión Electrónica Ajustable		
77803	D		143276
F 02-06	CADILLAC ESCALADE Todos Exc. Control de Manejo Electrónico		
F 03-06	ESCALADE ESV Todos Exc. Control de Manejo Electrónico		
F 03-06	ESCALADE EXT Todos Exc. Control de Manejo Electrónico		
F 02-06	CHEVROLET AVALANCHE 1500 Todos Exc. Control de Manejo Electrónico		
F 03-07	CHEYENNE		
F 99-06	PICKUP 1/2 TON, SILVERADO 1500 4x4 Estilo Carrocería Clasica y Antigua, Exc. Suspensión Electrónica Ajustable		
F 07	SILVERADO 1500 CLASSIC 4x4 Exc. Suspensión Electrónica Ajustable		
F 00-06	SONORA Todos Exc. Suspensión Z55		
F 00-06	SUBURBAN 1/2 TON, 1500 Todos Exc. Suspensión Z55 Auto Ride		
F 02-06	TAHOE Todos Exc. Suspensión Z55 Auto Ride		
F 00-01	TAHOE Todos Estilo New Body, Exc. Suspensión Z55		
F 99-06	GMC SIERRA 1500 4x4 Estilo Carrocería Clasica y Antigua, Exc. Suspensión Electrónica Ajustable		
F 07	SIERRA 1500 CLASSIC 4x4 Exc. Suspensión Electrónica Ajustable		
F 00-06	YUKON Todos Exc. Suspensión Z55 Auto Ride		
F 00-06	YUKON XL 1/2 TON Todos Exc. Suspensión Z55 Auto Ride		
77807	D		142617
F 99-12	FORD PICKUP 1 TON, F-350 / SUPERDUTY 4x2 Tracción trasera		
F 99-12	PICKUP 3/4 TON, F-250 / SUPERDUTY 4x2 Tracción trasera		
77808	W		
R 99-04	FORD PICKUP 1 TON, F-350 / SUPERDUTY 4x2 Tracción trasera		
R 99-04	PICKUP 3/4 TON, F-250 / SUPERDUTY 4x2 Tracción trasera		
77809	W		
F 00-05	FORD EXCURSION 4x4		
F 99-04	PICKUP 1 TON, F-350 / SUPERDUTY 4x4		
F 99-04	PICKUP 3/4 TON, F-250 / SUPERDUTY 4x4		
F 99-04	PICKUP, F-450 SUPERDUTY Todos		
F 99-04	PICKUP, F-550 SUPERDUTY Todos		
77810	D		
R 99-04	FORD PICKUP 1 TON, F-350 / SUPERDUTY 4x4		
R 99-04	PICKUP 3/4 TON, F-250 / SUPERDUTY 4x4		
77815	D		142389
R 00-06	TOYOTA TUNDRA Todos		
77817	D		141665
F 02-06	CHEVROLET AVALANCHE 2500 Todos Exc. Control de Manejo Electrónico		
F 05-06	PICKUP 1/2 TON, SILVERADO 1500 HD Todos		
F 01-03	PICKUP 1/2 TON, SILVERADO 1500 HD Todos		
F 01-09	PICKUP 1 TON, SILVERADO 3500 Todos		
F 07-10	PICKUP 1 TON, SILVERADO 3500 HD Todos		

Lista numérica

Amort.	POP	No. Alternativo	Montaje Accesorio
Pos.	Año	Aplicación	
77817	D	-continued	141665
F	05-08	PICKUP 3/4 TON, SILVERADO 2500 Todos	
F	99-04	PICKUP 3/4 TON, SILVERADO 2500 4x4	
F	01-10	PICKUP 3/4 TON, SILVERADO 2500 HD Todos PBV 9200	
F	00-11	SUBURBAN 3/4 TON, 2500 Todos Exc. Suspensión Auto Ride Z55 y QuadraSteer	
F	05-06	GMC SIERRA 1500 HD Todos	
F	01-03	SIERRA 1500 HD Todos	
F	99-04	SIERRA 2500 4x4	
F	01-10	SIERRA 2500 HD Todos	
F	01-06	SIERRA 3500 Todos	
F	07-10	SIERRA 3500 HD Barra de Torsion (FrontSpringType)	
F	00-06	YUKON XL 3/4 TON Todos Exc. Sistema de Autonivelación NIVOMAT	
F	03-07	HUMMER H2 Todos	
77829	D		
R	99-04	JEEP GRAND CHEROKEE Todos	
77837	W		
R	00-05	FORD EXCURSION 4x4	
77847	D		142592,141353
F	99-04	JEEP GRAND CHEROKEE Todos Exc. Suspensión Up Country	
77902	D		140857
F	82	CHEVROLET LUV PICKUP 4x2 Tracción trasera	
F	81-95	ISUZU PICKUP 4x2 Tracción trasera	
F	69-72	NISSAN 521 PICKUP Todos	
F	72-79	620 PICKUP Todos	
F	80-86	720 PICKUP Todos	
F	65-12	PICKUP	
77903	W		141376
F	85-95	TOYOTA PICKUP 4x2 Tracción trasera Exc. 1 Ton	
F	84	PICKUP 4x2 Tracción trasera	
F	93-98	T100 4x2 Tracción trasera	
77904	W		141356
F	87-91	ISUZU TROOPER Todos	
F	87-90	MITSUBISHI VAN Todos	
F	87-95	NISSAN PATHFINDER Todos Exc. Suspensión Electrónica Ajustable	
77905	W		140126
F	97-04	DODGE DAKOTA 4x4	
F	98-03	DURANGO 4x4	
77907	W		
R	75-80	CHEVROLET LUV PICKUP Todos	
R	72-74	LUV PICKUP Todos	
R	79-82	DODGE D50 4x2 Tracción trasera	
R	87-93	PICKUP, RAM 50 4x2 Tracción trasera	
R	83-86	PICKUP, RAM 50 Todos	
R	86-87	MAZDA B2000 4x2 Tracción trasera	
R	87-93	B2200 4x2 Tracción trasera	
R	87-93	B2600 4x2 Tracción trasera	
R	95-96	MITSUBISHI MIGHTY MAX Todos	
R	83-94	MIGHTY MAX 4x2 Tracción trasera	
R	87-90	VAN Todos	
R	98-04	NISSAN FRONTIER 4x2 Tracción trasera Exc. Desert Runner	
R	65-12	PICKUP	
R	79-82	PLYMOUTH ARROW PICKUP Todos	
R	85-95	TOYOTA PICKUP 4x2 Tracción trasera Exc. 1 Ton	
R	84	PICKUP 4x2 Tracción trasera	
R	70-83	PICKUP 4x2 Tracción trasera Mojave	
R	84-88	VAN Leaf (RearSpringType)	
R	88	VAN WAGON Leaf (FrontSpringType), Leaf (RearSpringType)	
77909	W		141368
F	82	CHEVROLET LUV PICKUP 4x4	
F	75-81	LUV PICKUP Todos	
F	72-74	LUV PICKUP Todos	
F	89-94	ISUZU AMIGO Todos	
F	81-95	PICKUP 4x4	
F	84-86	TROOPER Todos	
F	98-04	NISSAN FRONTIER 4x2 Tracción trasera Exc. Desert Runner	
F	65-94	PICKUP	

Amortiguador Monotubo MaxControl

Amort.	POP	No. Alternativo	Montaje Accesorio
Pos.	Año	Aplicación	
77915	W		141349
F	87-04	DODGE DAKOTA 4x2 Tracción trasera	
F	99-03	DURANGO 4x2 Tracción trasera	
77937	W		140673
F	01-04	TOYOTA TACOMA S-Runner Exc. Offroad Package	
F	04	TACOMA Base, 4x2 Tracción trasera Exc. Offroad Package	
F	95-03	TACOMA DLX, 4x2 Tracción trasera Exc. Offroad Package	
77947	W		142731
F	02-05	DODGE PICKUP 1/2 TON, RAM 1500 4x4	
77948	D		142731
F	03-10	DODGE PICKUP 1 TON, RAM 3500 4x4	
F	03-10	PICKUP 3/4 TON, RAM 2500 4x4	
F	11-13	RAM 2500 (SEE DODGE RAM 2500) 4x4	
F	11-13	3500 (SEE DODGE RAM 3500) 4x4	
77949	C		143000
F	03-10	DODGE PICKUP 1 TON, RAM 3500 4x2 Tracción trasera	
F	03-10	PICKUP 3/4 TON, RAM 2500 4x2 Tracción trasera	
F	11-12	RAM 2500	
F	11-12	RAM 3500	
F	11-13	RAM 2500 (SEE DODGE RAM 2500) 4x2 Tracción trasera	
F	11-13	3500 (SEE DODGE RAM 3500) 4x2 Tracción trasera	
77950	C		
R	03-10	DODGE PICKUP 1 TON, RAM 3500 Todos	
R	03-10	PICKUP 3/4 TON, RAM 2500 Todos	
R	11-12	RAM 2500	
R	11-12	RAM 3500	
R	11-13	RAM 2500 (SEE DODGE RAM 2500) Todos	
R	11-13	3500 (SEE DODGE RAM 3500) Todos	
77951	W		142731
F	05-12	FORD PICKUP 1 TON, F-350 / SUPERDUTY 4x4	
F	05-12	PICKUP 3/4 TON, F-250 / SUPERDUTY 4x4	
77952	D		
R	05-12	FORD PICKUP 1 TON, F-350 / SUPERDUTY Crew Cab Pickup, 4x4 Rodada Trasera Sencilla	
R	05-12	PICKUP 1 TON, F-350 / SUPERDUTY Extended Cab Pickup, 4x4 Rodada Trasera Sencilla	
R	05-12	PICKUP 1 TON, F-350 / SUPERDUTY Standard Cab Pickup, 4x4 Rodada Trasera Sencilla	
R	05-16	PICKUP 3/4 TON, F-250 / SUPERDUTY 4x4	
77953	W		
R	02-10	CADILLAC ESCALADE Todos	
R	07-11	CHEVROLET AVALANCHE 1500 Todos Exc. Suspensión Z55 o ZW7	
R	02-06	AVALANCHE 1500 Todos Exc. Control de Manejo Electrónico	
R	02-06	AVALANCHE 2500 Todos Exc. Control de Manejo Electrónico	
R	00-06	SONORA Todos Exc. Suspensión Z55	
R	07-11	SUBURBAN 1/2 TON, 1500 Todos Exc. Suspensión Z55 o ZW7	
R	00-06	SUBURBAN 1/2 TON, 1500 Todos Exc. Suspensión Z55 Auto Ride	
R	00-11	SUBURBAN 3/4 TON, 2500 Todos Exc. Suspensión Auto Ride Z55 y QuadraSteer	
R	07-11	TAHOE Todos Exc. Suspensión Z55 o ZW7	
R	02-06	TAHOE Todos Exc. Suspensión Z55 Auto Ride	
R	00-01	TAHOE Todos Estilo New Body, Exc. Suspensión Z55	
R	07-11	GMC YUKON Todos Exc. Suspensión Z55 o ZW7	
R	00-06	YUKON Todos Exc. Suspensión Z55 Auto Ride	
R	07-11	YUKON XL 1/2 TON Todos Exc. Suspensión Z55 o ZW7	

Lista numérica

Amort.	POP	No. Alternativo	Montaje Accesorio
Pos.	Año	Aplicación	
77953	W	-continued	
R	00-06	YUKON XL 1/2 TON Todos Exc. Suspensión Z55 Auto Ride	
R	07-11	YUKON XL 3/4 TON Todos Exc. Suspensión Z55 o ZW7	
R	00-06	YUKON XL 3/4 TON Todos Exc. Sistema de Autonivelación NIVOMAT	
77954	W		143276
F	06-08	DODGE PICKUP 1/2 TON, RAM 1500 Crew Cab Pickup, 4x2 Tracción trasera	
F	06-08	PICKUP 1/2 TON, RAM 1500 Standard Cab Pickup, 4x2 Tracción trasera	
F	02-05	PICKUP 1/2 TON, RAM 1500 4x2 Tracción trasera	
77955	W		142486
R	03-10	FORD CROWN VICTORIA Police Interceptor Modelos Policía y Taxi	
R	03-11	LINCOLN TOWN CAR Todos	
77958	W		140126
F	87-96	DODGE DAKOTA 4x4	
77967	D		143146
F	05-08	FORD PICKUP, F-450 SUPERDUTY Todos	
F	05-07	PICKUP, F-550 SUPERDUTY Todos	
77968	D		
R	05-07	FORD PICKUP, F-450 SUPERDUTY 4 X 2	
R	05-07	PICKUP, F-550 SUPERDUTY 4 X 2	
77969	W		
R	05-07	FORD PICKUP, F-450 SUPERDUTY 4 X 4	
R	05-07	PICKUP, F-550 SUPERDUTY 4 X 4	
77971	FF		
R	02-09	CHEVROLET TRAILBLAZER Coil (RearSpringType)	
R	02-06	TRAILBLAZER EXT Todos	
R	02-09	GMC ENVOY Coil (RearSpringType)	
R	02-06	ENVOY XL Todos	
R	04-05	ENVOY XUV Todos	
77972	FF		
F	07-12	JEEP WRANGLER Todos	
77973	FF		
R	07-14	JEEP WRANGLER Unlimited Sahara, 4x4	
R	07-11	WRANGLER Unlimited X, 4x4	
R	07-11	WRANGLER X	
77974	FF		
R	15	CHEVROLET PICKUP 1/2 TON, SILVERADO 1500 Todos Plataforma K2XX	
R	15	GMC SIERRA 1500 Todos Plataforma K2XX	
77975	D		
R	14	CHEVROLET SUBURBAN 1/2 TON, 1500 Todos	
R	12-14	TAHOE Todos	
R	12-14	GMC YUKON Todos	
77976	D		
R	07-13	CHEVROLET PICKUP 1/2 TON, SILVERADO 1500 Todos	
R	07-13	GMC SIERRA 1500 Todos	
77978	FF		141665
F	97-06	JEEP WRANGLER Todos	
77979	D		
R	97-06	JEEP WRANGLER Todos	
77980	FF		142731
F	06-08	DODGE PICKUP 1/2 TON, RAM 1500 4x4, 5.7L 8Cyl V (345)	
F	06	PICKUP 1 TON, RAM 3500 4x4, 5.7L 8Cyl V (345)	
F	06	PICKUP 3/4 TON, RAM 2500 4x4, 5.7L 8Cyl V (345)	
77981	FF		142973
F	07-12	JEEP WRANGLER Todos	
77983	FF		
R	06-10	HUMMER H3 Todos w/Off Road Package	

Lista numérica

Amort.	POP	No. Alternativo	Montaje Accesorio
Pos.	Año	Aplicación	

Amortiguadores Guardian

81039	B		140357
F	75-84	CHEVROLET BLAZER 4x2 Tracción trasera	
F	69-74	BLAZER Todos 4x2 Tracción trasera	
F	65-66	C1405	
F	67	C3605	
F	65-67	C20905	
F	64-78	CS1073	
F	64-78	CS31003	
F	63-86	PICKUP 1/2 TON, C10 Todos	
F	87	PICKUP 1/2 TON, R10 Todos	
F	63-86	PICKUP 1 TON, C30 Todos	
F	88-91	PICKUP 1 TON, C35/3500 Cab & Chassis	
F	87-88	PICKUP 1 TON, R30 Todos	
F	90-91	PICKUP 1 TON, R3500 Todos	
F	89	PICKUP 1 TON, R3500 Standard Cab Pickup	
F	75-86	PICKUP 3/4 TON, C20 Crew Cab Pickup	
F	75-86	PICKUP 3/4 TON, C20 Standard Cab Pickup	
F	63-74	PICKUP 3/4 TON, C20 Todos	
F	88	PICKUP 3/4 TON, R20 Todos	
F	87	PICKUP 3/4 TON, R20 Crew Cab Pickup	
F	89	PICKUP 3/4 TON, R2500 Todos	
F	63-66	SUBURBAN 1/2 TON, 1500 Todos	
F	67-86	SUBURBAN 1/2 TON, C10 Todos	
F	87-88	SUBURBAN 1/2 TON, R10 Todos	
F	89-91	SUBURBAN 1/2 TON, R1500 Todos	
F	68-86	SUBURBAN 3/4 TON, C20 Todos	
F	87-88	SUBURBAN 3/4 TON, R20 Todos	
F	89-91	SUBURBAN 3/4 TON, R2500 Todos	
F	63-80	VAN 1/2 TON, P SERIES Todos	
F	68-90	VAN 1 TON, P SERIES Todos Exc. Chasis Motorhome	
F	68-89	VAN 3/4 TON, P SERIES Todos	
F	75-84	GMC JIMMY 4x2 Tracción trasera	
F	70-74	JIMMY Todos 4x2 Tracción trasera	
F	91	P3500	
F	67-86	PICKUP 1/2 TON, C15 / C1500 Todos	
F	87	PICKUP 1/2 TON, R1500 Todos	
F	88-91	PICKUP 1 TON, C35/3500 Cab & Chassis	
F	67-78	PICKUP 1 TON, C35/3500 Todos	
F	87-91	PICKUP 1 TON, R3500 Todos	
F	75-86	PICKUP 3/4 TON, C25 / C2500 Cab & Chassis	
F	75-86	PICKUP 3/4 TON, C25 / C2500 Crew Cab Pickup	
F	75-86	PICKUP 3/4 TON, C25 / C2500 Standard Cab Pickup	
F	67-74	PICKUP 3/4 TON, C25 / C2500 Todos	
F	87-89	PICKUP 3/4 TON, R2500 Todos Exc. Crew Cab y Bonus Cab	
F	63-65	PICKUP 1000 SERIES Todos	
F	63-65	PICKUP 1500 SERIES Todos	
F	73-86	SUBURBAN 1/2 TON, C15 / C1500 Todos	
F	68-72	SUBURBAN 1/2 TON, C15 / C1500 Todos Resortes Helicoidales Delanteros	
F	87-91	SUBURBAN 1/2 TON, R1500 Todos	
F	68-86	SUBURBAN 3/4 TON, C25 / C2500 Todos	
F	87-91	SUBURBAN 3/4 TON, R2500 Todos	
F	67-80	VAN 1/2 TON, P SERIES Todos	
F	91	VAN 1 TON, P SERIES Todos	
F	75-90	VAN 1 TON, P SERIES Todos Exc. Chasis Motorhome	
F	73-74	VAN 1 TON, P SERIES Base Exc. Chasis Motorhome	
F	68-72	VAN 1 TON, P SERIES Todos	
F	68-89	VAN 3/4 TON, P SERIES Todos	
F	63-65	VAN, PB 1000 SERIES Todos	
81076	D		140496
F	70-77	FORD MAVERICK Todos	
F	67-70	MUSTANG / MUSTANG II Todos	
F	71-77	MERCURY COMET Todos	
F	67-70	COUGAR Todos	
81082	C		
R	92	FORD B200	
R	85-96	PICKUP 1/2 TON, F-150 4x2 Tracción trasera	
R	80-97	PICKUP 1 TON, F-350 / SUPERDUTY 4x2 Tracción trasera Exc. Doble Rodada Trasera	

Amortiguadores Guardian

Amort.	POP	No. Alternativo	Montaje Accesorio
Pos.	Año	Aplicación	

81082	C	-continued	
R	97	PICKUP 3/4 TON, F-250 / SUPERDUTY 4x2 Tracción trasera PBV arriba de 8500#	
R	80-96	PICKUP 3/4 TON, F-250 / SUPERDUTY 4x2 Tracción trasera	
81091	D		
R	67-73	CHRYSLER IMPERIAL Todos	
R	70-73	NEWPORT Todos	
R	70-73	NEW YORKER Todos	
R	71-73	TOWN & COUNTRY Todos	
R	88-93	DODGE MICROBUS	
R	73	MONACO Todos	
R	71	MONACO Todos	
R	72-93	PICKUP 1/2 TON, D100 SERIES Todos	
R	72-93	PICKUP 1 TON, D300 SERIES Todos	
R	72-93	PICKUP 3/4 TON, D200 SERIES Todos	
R	73	POLARA Todos	
R	71	POLARA Todos	
R	95-96	RAMCHARGER 4x2 Tracción trasera	
R	74-93	RAMCHARGER 4x2 Tracción trasera	
R	70-73	PLYMOUTH FURY Todos	
R	73	FURY Todos Exc. Wagon	
R	73	GRAN FURY Hardtop	
R	72	GRAN FURY Todos	
R	75-81	TRAILDUSTER 4x2 Tracción trasera	
R	74	TRAILDUSTER Todos	
81095	W		140524
R	70-81	CHEVROLET CAMARO Todos	
R	70-81	PONTIAC FIREBIRD Todos	
81096	C		140126
F	84-86	DODGE MINI RAM Todos	
F	72-93	PICKUP 1/2 TON, D100 SERIES Todos	
F	94	PICKUP 1 TON, RAM 3500 Todos	
F	72-93	PICKUP 3/4 TON, D200 SERIES Todos Exc. Paquete HD	
F	95-96	RAMCHARGER Todos	
F	75-93	RAMCHARGER 4x2 Tracción trasera	
F	99-03	VAN 1/2 TON, A / B SERIES / RAM 109.3 (WheelBase) Exc. PBV 7000#	
F	81-98	VAN 1/2 TON, A / B SERIES / RAM 109.6 (WheelBase) Exc. PBV 7000#	
F	71-80	VAN 1/2 TON, A / B SERIES / RAM Todos	
F	99-03	VAN 1 TON, A / B SERIES / RAM Todos	
F	71-98	VAN 1 TON, A / B SERIES / RAM Todos Exc. Eje Delantero 4000#	
F	71-03	VAN 3/4 TON, A / B SERIES / RAM Todos	
F	74-80	VAN, CB300 Todos Exc. Eje Delantero 4000#	
F	75-81	PLYMOUTH TRAILDUSTER 4x2 Tracción trasera	
F	74-83	VAN 1/2 TON, PB SERIES Todos	
F	74-83	VAN 1 TON, PB SERIES Todos Exc. Eje Delantero 4000#	
F	74-83	VAN 3/4 TON, PB SERIES Todos	
81097	C		140524
R	69-72	NISSAN 521 PICKUP Todos	
R	72-79	620 PICKUP Todos	
R	86	720 PICKUP 4x2 Tracción trasera Fabricado antes de 8/86	
R	82-85	720 PICKUP 4x2 Tracción trasera	
R	80-81	720 PICKUP Todos	
81108	D		
F	71-95	CHEVROLET VAN 1/2 TON, G / EXPRESS Todos	
F	70	VAN 1/2 TON, G / EXPRESS Todos Suspensión Delantero Independiente	
F	76-96	VAN 1 TON, G / EXPRESS Todos	
F	75	VAN 1 TON, G / EXPRESS 146.0 (WheelBase)	
F	71-74	VAN 1 TON, G / EXPRESS Todos	
F	78-95	VAN 3/4 TON, G / EXPRESS Todos Exc. PBV 8600 #	
F	71-77	VAN 3/4 TON, G / EXPRESS Todos	
F	70	VAN 3/4 TON, G / EXPRESS Todos Suspensión Delantero Independiente	
F	71-95	GMC VAN 1/2 TON, G / SAVANNA Todos	
F	70	VAN 1/2 TON, G / SAVANNA Todos Suspensión Delantero Independiente	
F	76-95	VAN 1 TON, G / SAVANNA Todos	

Lista numérica

Amort.	POP	No. Alternativo	Montaje Accesorio
Pos.	Año	Aplicación	

81108	D	-continued	
F	75	VAN 1 TON, G / SAVANNA 146.0 (WheelBase)	
F	71-74	VAN 1 TON, G / SAVANNA Todos	
F	78-95	VAN 3/4 TON, G / SAVANNA Todos Exc. PBV 8600 #	
F	71-77	VAN 3/4 TON, G / SAVANNA Todos	
F	70	VAN 3/4 TON, G / SAVANNA Todos Suspensión Delantero Independiente	
81113	D		
F	87-91	CHEVROLET BLAZER 4x4 Automóvil Grande; Suspensión Quad Amortiguador Corto; Exc. Kit de Levantamiento	
F	81-86	BLAZER 4x4 Suspensión Quad Amortiguador Corto; Exc. Kit de Levantamiento	
F	75-80	BLAZER 4x4 Exc. Suspensión Quad y Kit de Levantamiento	
F	73-74	BLAZER 4x4 Exc. Kit de Levantamiento	
F	69-72	BLAZER 4x4	
F	81-86	PICKUP 1/2 TON, K10 Todos Suspensión Estándar; Exc. Kit de Levantamiento	
F	69-80	PICKUP 1/2 TON, K10 Todos Exc. Kit de Levantamiento	
F	87	PICKUP 1/2 TON, V10 Todos Suspensión Quad Amortiguador Corto; Exc. Kit de Levantamiento	
F	81-86	PICKUP 3/4 TON, K20 Todos Suspensión Estándar; Exc. Kit de Levantamiento	
F	69-80	PICKUP 3/4 TON, K20 Todos Exc. Kit de Levantamiento	
F	81-86	SUBURBAN 1/2 TON, K10 Todos Suspensión Estándar; Exc. Kit de Levantamiento	
F	69-80	SUBURBAN 1/2 TON, K10 Todos Exc. Kit de Levantamiento	
F	87-88	SUBURBAN 1/2 TON, V10 Todos Suspensión Quad Amortiguador Corto; Exc. Kit de Levantamiento	
F	81-86	SUBURBAN 3/4 TON, K20 Todos Suspensión Estándar; Exc. Kit de Levantamiento	
F	69-80	SUBURBAN 3/4 TON, K20 Todos Exc. Kit de Levantamiento	
F	87-88	SUBURBAN 3/4 TON, V20 Todos Suspensión Quad Amortiguador Corto; Exc. Kit de Levantamiento	
F	89-91	SUBURBAN 3/4 TON, V2500 Todos Suspensión Quad Amortiguador Corto; Exc. Kit de Levantamiento	
F	70-91	GMC JIMMY 4x4 Exc. Suspensión Quad y Kit de Levantamiento	
F	69-86	PICKUP 1/2 TON, K15 / K1500 Todos Exc. Suspensión Quad y Kit de Levantamiento	
F	87	PICKUP 1/2 TON, V1500 Todos Suspensión Quad Amortiguador Corto; Exc. Kit de Levantamiento	
F	69-86	PICKUP 3/4 TON, K25 / K2500 Todos Exc. Suspensión Quad y Kit de Levantamiento	
F	87	PICKUP 3/4 TON, V2500 Todos Suspensión Quad Amortiguador Corto; Exc. Kit de Levantamiento	
F	69-86	SUBURBAN 1/2 TON, K15 / K1500 Todos Exc. Suspensión Quad y Kit de Levantamiento	
F	87-91	SUBURBAN 1/2 TON, V1500 Todos Suspensión Quad Amortiguador Corto; Exc. Kit de Levantamiento	
F	69-86	SUBURBAN 3/4 TON, K25 / K2500 Todos Exc. Suspensión Quad y Kit de Levantamiento	
F	87-91	SUBURBAN 3/4 TON, V2500 Todos Suspensión Quad Amortiguador Corto; Exc. Kit de Levantamiento	
81147	A		
R	56	BUICK ROADMASTER Todos Exc. Suspensión de Aire	
R	56	SPECIAL Todos	
R	56	SUPER Todos	
R	75-80	CHEVROLET LUV PICKUP Todos	
R	72-74	LUV PICKUP Todos	
F	55-56	PICKUP 3200	
F	55-56	PICKUP 3600	
F	55-56	PICKUP 3800	
F	55	PICKUP 3100	
R	79-82	DODGE D50 4x2 Tracción trasera	

Lista numérica

Amort.	POP	No. Alternativo	Montaje Accesorio
Pos.	Año	Aplicación	
81147	A -continued		
R	83-93	PICKUP, RAM 50 4x2	Tracción trasera
R	55	FORD F SERIES Todos	F-100
F	48-52	F SERIES Todos	F-1, F-2 y F-3
F	68-75	PICKUP P350 Todos	Hasta PBV 8000#
F	75-76	PICKUP P400 Todos	Hasta PBV 8000#
R	68	INTERNATIONAL 908C	Todos
R	68	1000C	Todos
F	68	1100C Todos	Exc. Travelette c/ base de rueda de 166"
R	68	1100C Todos	Exc. Travelette c/ base de rueda de 166"
F	68	1200C Todos	Exc. Travelette c/ base de rueda de 166"
R	68	1200C Todos	Exc. Travelette c/ base de rueda de 166"
F	68	1300C Todos	Exc. Travelette c/ base de rueda de 166"
R	68	1300C Todos	Exc. Travelette c/ base de rueda de 166"
R	68-72	M1100 / M1200	Todos
R	69	M1400	Todos
R	72-83	JEEP CJ5 Todos	Exc. Kit de Levantamiento
R	66-71	CJ5 Todos	Exc. 5 Resortes Helicoidales Delanteros y Kit de Levantamiento
R	73-83	CJ5D	
R	65-71	CJ5D	
R	65-71	CJ5S	
R	66-75	CJ6 Todos	Exc. Kit de Levantamiento
R	65-75	CJ7	
R	76-86	CJ7 Todos	Exc. Kit de Levantamiento
R	84-85	CJ10	
R	66-74	DJ5 Todos	Exc. Kit de Levantamiento
R	66-68	DJ6	Todos
R	57-60	FC150	Todos
F	63-65	FC170	Todos
R	63-65	FC170	Todos
R	64-66	GLADIATOR	Todos
R	63	GLADIATOR	Todos Suspensión Delantera Independiente
R	68-69	J162	
R	65	J162	
R	65-70	J164	
R	65-70	J164V	
R	71	J262S	
R	68-69	J262S	
R	65	J264D	
R	70-73	JEEPSTER	Todos
R	81-85	SCRAMBLER / CJ8	Todos
R	61-67	UNIVERSAL	Todos Exc. CJ-3B
R	86-87	MAZDA B2000 4x2	Tracción trasera
R	87-93	B2200 4x2	Tracción trasera
R	87-93	B2600 4x2	Tracción trasera
R	95-96	MITSUBISHI MIGHTY MAX	Todos
R	83-94	MIGHTY MAX 4x2	Tracción trasera
R	87-90	VAN Todos	
R	79-84	NISSAN DATSUN	
R	98-04	FRONTIER 4x2	Tracción trasera Exc. Desert Runner
R	87-93	ICHIVAN	
R	79-84	NISSAN SEDAN	
R	65-12	PICKUP	
R	00-13	URVAN	Todos
R	79-82	PLYMOUTH ARROW	PICKUP Todos
R	67-68	TOYOTA LAND CRUISER	Todos
R	85-95	PICKUP 4x2	Tracción trasera Exc. 1 Ton
R	84	PICKUP 4x2	Tracción trasera
R	70-83	PICKUP 4x2	Tracción trasera Mojave
R	84-88	VAN Leaf (RearSpringType)	
R	88	VAN WAGON	Todos Resorte Trasero de Hojas Múltiples

81153	D		
F	75-79	CHRYSLER CORDOBA	Todos
F	79-81	NEWPORT	Todos
F	79-81	TOWN & COUNTRY	Todos
F	73-78	DODGE CHARGER	Todos
F	73-76	CORONET	Todos
F	78-79	MAGNUM	Todos
F	77-78	MONACO	Todos
F	79-81	ST. REGIS	Todos
F	75-78	PLYMOUTH FURY	Todos
F	80-81	GRAN FURY	Todos
F	73-75	ROADRUNNER	Todos

Amortiguadores Guardian

Amort.	POP	No. Alternativo	Montaje Accesorio
Pos.	Año	Aplicación	
81153	D -continued		
F	73-74	SATELLITE	Todos
81164	C 140357		
R	87-91	CHEVROLET BLAZER	Todos Automóvil Grande, Exc. Suspensión Quad y Kit de Levantamiento
R	73-86	BLAZER	Todos Exc. Kit de Levantamiento
R	73-78	CS1073	
R	73-78	CS31003	
R	73-86	PICKUP 1/2 TON, C10	Todos
R	73-86	PICKUP 1/2 TON, K10	Todos Exc. Suspensión Quad y Kit de Levantamiento
R	87	PICKUP 1/2 TON, R10	Todos
R	87	PICKUP 1/2 TON, V10	Todos Exc. Suspensión Quad y Kit de Levantamiento
R	75-86	PICKUP 3/4 TON, C20	Standard Cab Pickup
R	73-74	PICKUP 3/4 TON, C20	Todos Standard Cab Pickup
R	73-86	PICKUP 3/4 TON, K20	Todos Exc. Suspensión Quad y Kit de Levantamiento
R	87	PICKUP 3/4 TON, R20	Standard Cab Pickup
R	87	PICKUP 3/4 TON, V20	Todos Exc. Suspensión Quad y Kit de Levantamiento
R	73-86	SUBURBAN 1/2 TON, C10	Todos
R	75-86	SUBURBAN 1/2 TON, K10	Todos Exc. Suspensión Quad y Kit de Levantamiento
R	87-88	SUBURBAN 1/2 TON, R10	Todos
R	89-91	SUBURBAN 1/2 TON, R1500	Todos
R	89-91	SUBURBAN 1/2 TON, V1500	Todos Exc. Kit de Levantamiento
R	73-86	SUBURBAN 3/4 TON, C20	Todos
R	73-86	SUBURBAN 3/4 TON, K20	Todos Exc. Kit de Levantamiento
R	87-88	SUBURBAN 3/4 TON, R20	Todos
R	89-91	SUBURBAN 3/4 TON, R2500	Todos
R	87-88	SUBURBAN 3/4 TON, V20	Todos Exc. Suspensión Quad y Kit de Levantamiento
R	89-91	SUBURBAN 3/4 TON, V2500	Todos Exc. Suspensión Quad y Kit de Levantamiento
R	73	VAN 1/2 TON, P SERIES	Todos
R	73-78	VAN 3/4 TON, P SERIES	Todos
R	73-91	GMC JIMMY	Todos Exc. Kit de Levantamiento
R	73-86	PICKUP 1/2 TON, C15 / C1500	Todos
R	73-86	PICKUP 1/2 TON, K15 / K1500	Todos Exc. Kit de Levantamiento
R	87	PICKUP 1/2 TON, R1500	Todos
R	87	PICKUP 1/2 TON, V1500	Todos Exc. Kit de Levantamiento
R	75-86	PICKUP 3/4 TON, C25 / C2500	Cab & Chassis
R	75-86	PICKUP 3/4 TON, C25 / C2500	Standard Cab Pickup
R	73-86	PICKUP 3/4 TON, K25 / K2500	Todos Exc. Kit de Levantamiento
R	88-89	PICKUP 3/4 TON, R2500	Todos Exc. Crew Cab y Bonus Cab
R	87	PICKUP 3/4 TON, R2500	Cab & Chassis Exc. Crew Cab y Bonus Cab
R	87	PICKUP 3/4 TON, R2500	Standard Cab Pickup Exc. Crew Cab y Bonus Cab
R	87	PICKUP 3/4 TON, V2500	Todos Exc. Kit de Levantamiento
R	73-86	SUBURBAN 1/2 TON, C15 / C1500	Todos
R	73-86	SUBURBAN 1/2 TON, K15 / K1500	Todos Exc. Kit de Levantamiento
R	87-91	SUBURBAN 1/2 TON, R1500	Todos
R	87-91	SUBURBAN 1/2 TON, V1500	Todos Exc. Kit de Levantamiento
R	75-86	SUBURBAN 3/4 TON, C25 / C2500	Todos
R	73-74	SUBURBAN 3/4 TON, C25 / C2500	Todos Exc. Crew Cab y Bonus Cab
R	73-86	SUBURBAN 3/4 TON, K25 / K2500	Todos Exc. Kit de Levantamiento
R	87-91	SUBURBAN 3/4 TON, R2500	Todos
R	87-91	SUBURBAN 3/4 TON, V2500	Todos Exc. Kit de Levantamiento
R	73	VAN 1/2 TON, P SERIES	Todos
R	73-78	VAN 3/4 TON, P SERIES	Todos

Lista numérica

Amort.	POP	No. Alternativo	Montaje Accesorio
Pos.	Año	Aplicación	
81174	D		
R	73-78	CHEVROLET CS31003	
R	99	P31	
R	73-86	PICKUP 1 TON, C30	Todos
R	88-91	PICKUP 1 TON, C35/3500	Cab & Chassis Exc. Eje Rígido Delantero HD
R	87-88	PICKUP 1 TON, R30	Todos
R	89	PICKUP 1 TON, R3500	Standard Cab Pickup
R	75-86	PICKUP 3/4 TON, C20	Crew Cab Pickup
R	73-74	PICKUP 3/4 TON, C20	Todos Crew Cab Pickup
R	88	PICKUP 3/4 TON, R20	Todos
R	87	PICKUP 3/4 TON, R20	Crew Cab Pickup
R	89	PICKUP 3/4 TON, R2500	Todos
R	74-80	VAN 1/2 TON, P SERIES	Todos
R	73-99	VAN 1 TON, P SERIES	Todos
R	79-89	VAN 3/4 TON, P SERIES	Todos
R	91	GMC P3500	
R	88-91	PICKUP 1 TON, C35/3500	Cab & Chassis Exc. Eje Rígido Delantero HD
R	73-78	PICKUP 1 TON, C35/3500	Todos
R	87-91	PICKUP 1 TON, R3500	Todos
R	85-86	PICKUP 3/4 TON, C25 / C2500	Crew Cab Pickup
R	75-83	PICKUP 3/4 TON, C25 / C2500	Crew Cab Pickup
R	87-89	PICKUP 3/4 TON, R2500	Crew Cab Pickup
R	74-80	VAN 1/2 TON, P SERIES	Todos
R	74-99	VAN 1 TON, P SERIES	Todos
R	73	VAN 1 TON, P SERIES	Base Exc. Chasis Motorhome
R	79-89	VAN 3/4 TON, P SERIES	Todos
81242	D 140126		
R	79-81	FORD B100	
R	74	B100	
R	75-78	B150	
R	66	BRONCO	Todos Toda la serie #830000
R	75-79	PICKUP 1/2 TON, F-100	4x2 Tracción trasera
R	75-79	PICKUP 1/2 TON, F-150	4x2 Tracción trasera
R	75-79	PICKUP 1 TON, F-350 / SUPERDUTY	Extended Cab Pickup, 4x2 Tracción trasera
R	75-79	PICKUP 3/4 TON, F-250 / SUPERDUTY	Cab & Chassis, 4x2 Tracción trasera
R	75-79	PICKUP 3/4 TON, F-250 / SUPERDUTY	Standard Cab Pickup, 4x2 Tracción trasera
R	75-91	VAN 1/2 TON, ECONOLINE / CLUB	WAGON Todos
F	71-80	INTERNATIONAL SCOUT II	Todos
81270	D 140523		
R	75-80	AMERICAN MOTORS PACER	Todos
F	58	BUICK CENTURY	Todos
F	58	LIMITED	Todos
F	58	ROADMASTER	Todos Exc. Suspensión de Aire
F	58	SPECIAL	Todos Exc. Suspensión de Aire
F	58	SUPER	Todos Exc. Suspensión de Aire
F	55	CHEVROLET PICKUP	Todos Primeras Series
F	54	PICKUP	Todos
F	50-53	PICKUP 3100	
F	50-53	PICKUP 3600	
F	50-53	PICKUP 3800	
R	90-92	DAIHATSU ROCKY	Todos
R	52-59	FORD COUNTRY SEDAN	Todos
R	52-56	COUNTRY SQUIRE	Todos
R	54-56	COURIER SEDAN	DELIVERY Todos
R	52-54	CRESTLINE	Todos
R	57	CUSTOM	Todos
R	52	CUSTOM	Todos
R	58	CUSTOM 300	Todos
R	52-56	CUSTOMLINE	Todos
R	62-70	FAIRLANE	Todos
R	55-58	FAIRLANE	Todos
R	66-70	FALCON	Todos Exc. Wagon
R	60-65	FALCON	Todos
F	57-59	F SERIES	Todos
R	52-56	MAINLINE	Todos

Lista numérica

Amort.	POP	No. Alternativo	Montaje Accesorio
Pos.	Año	Aplicación	
81270	D	-continued	140523
R	65-73	MUSTANG / MUSTANG II Todos	
R	56	PARK LANE WAGON Todos	
R	60-65	RANCHERO Todos	
R	52-56	RANCH WAGON Todos	
R	54-56	SKYLINER Todos	
R	52-58	SUNLINER Todos	
R	55-57	THUNDERBIRD Todos	
R	68-70	TORINO Todos Exc. Wagon	
R	52-58	VICTORIA Todos	
F	53-54	GMC PICKUP Todos	
R	62-64	JAGUAR XKE Todos	
R	72-77	MAZDA 808 Wagon Exc. Vehículos c/ Stuts Tokico de EO	
R	79-83	GLC Wagon	
R	78	GLC Todos	
R	74-76	RX3 Wagon	
R	72-73	RX3 Todos	
R	74-78	RX4 Todos	
R	59-60	MERCURY COLONY PARK Todos	
R	68-69	COMET Todos	
R	66-67	COMET Convertible	
R	66-67	COMET Hardtop	
R	66-67	COMET Sedan	
R	60-65	COMET Todos	
R	59-60	COMMUTER Todos	
R	67-73	COUGAR Todos	
R	59-60	COUNTRY CRUISER Todos	
R	62-63	METEOR Todos	
R	59-60	MONTCLAIR Todos	
R	68-71	MONTEGO Todos Exc. Wagon	
R	59-60	MONTEREY Todos	
R	59-60	PARKLANE Todos	
R	59	VOYAGER Todos	
R	69-78	SAAB 99 Todos	
R	59-68	VOLVO 122 Todos	
81285	D		140126
R	85-91	FORD B200	
R	75-76	PICKUP 1/2 TON, F-100 4x4 Exc. Kit de Levantamiento	
R	76-79	PICKUP 1/2 TON, F-150 4x4 Exc. Kit de Levantamiento	
R	75	PICKUP 1/2 TON, F-150 Todos 4x4; Exc. Kit de Levantamiento	
R	79	PICKUP 1 TON, F-350 / SUPERDUTY 4x4	
R	77-79	PICKUP 3/4 TON, F-250 / SUPERDUTY Cab & Chassis, 4x4 Aplica para toda la serie No. Y20001	
R	77-79	PICKUP 3/4 TON, F-250 / SUPERDUTY Standard Cab Pickup, 4x4 Aplica para toda la serie No. Y20001	
R	75-91	VAN 1 TON, ECONOLINE / CLUB WAGON / SUPERDUTY Todos Exc. Conversión Motorhome	
R	75-91	VAN 3/4 TON, ECONOLINE / CLUB WAGON / SUPERDUTY Todos	
81318	B		141137
R	97	CHEVROLET LUV PICKUP Todos	
R	81-82	LUV PICKUP Todos	
R	55	PICKUP 3100	
R	87-89	DODGE RAIDER 2.6L 4Cyl L (156) Exc. Sport Utility	
F	61-67	FORD ECONOLINE Todos	
F	68-72	INTERNATIONAL M1100 / M1200 Todos	
R	89-94	ISUZU AMIGO Todos	
R	81-95	PICKUP Todos	
R	84-86	TROOPER Todos	
R	86-92	JEEP COMANCHE Todos	
F	66-67	GLADIATOR Todos	
F	64-65	GLADIATOR Todos Exc. Suspensión Independiente Delantera	
F	68-69	J162	
F	65	J162	
F	65-73	J164	
F	65-73	J164V	
F	71	J262S	
F	68-69	J262S	
F	67	J264D	
F	65	J264D	
F	65-73	J364R	
F	68-73	J2500 PICKUP Todos	
F	66-73	WAGONEER Todos	
F	63-65	WAGONEER Todos Exc. Suspensión Independiente Delantera	
R	49-51	MERCURY MERCURY Todos	
R	50-51	MONTEREY Todos	
R	83-89	MINIBUS MONTERO 2.6L 4Cyl L (156)	
R	89	MONTERO 3.0L 6Cyl V (181)	
R	82-86	NISSAN 720 PICKUP 4x4	

Amortiguadores Guardian

Amort.	POP	No. Alternativo	Montaje Accesorio
Pos.	Año	Aplicación	
81318	B	-continued	141137
R	00-04	FRONTIER Crew Cab Pickup, 4x2 Tracción trasera con Desert Runner	
R	98-04	FRONTIER 4x4	
R	98-99	FRONTIER 4x2 Tracción trasera Crew Cab con Desert Runner	
R	87-95	PATHFINDER Todos Exc. Suspensión Electrónica Ajustable	
R	65-94	PICKUP	
R	57-60	PONTIAC BONNEVILLE Todos Exc. Wagon	
R	58-60	CATALINA Todos Exc. Suspensión de Aire y Wagon	
R	58	CHIEFTAIN Todos Exc. Suspensión de Aire y Wagon	
R	58-60	STAR CHIEF Todos	
R	58	SUPER CHIEF Todos	
R	60	VENTURA Todos	
R	84-87	TOYOTA LAND CRUISER FJ60 (Código plataforma del fabricante), Sport Utility	
R	75-83	LAND CRUISER Todos	
R	69-74	LAND CRUISER Todos Wagon	
R	85-92	PICKUP 4x2 Tracción trasera 1 Ton	
R	80-83	PICKUP 4x4 Exc. Kit de Levantamiento	
81322	W		141041
F	76-87	CHEVROLET CHEVETTE Todos	
F	81-84	ISUZU I-MARK Todos	
F	83-89	IMPULSE Todos	
F	76-87	PONTIAC ACADIAN Todos	
F	81-87	T1000 Todos	
81338	D		140873
R	77-83	CHRYSLER CORDOBA Todos	
R	77-81	DART	
R	83-89	FIFTH AVENUE Todos	
R	81-83	IMPERIAL Todos	
R	77-81	LEBARON Todos	
R	81	LEBARON Todos Carrocería M	
R	77-82	MAGNUM	
R	79-81	NEWPORT Todos	
R	79-82	NEW YORKER Todos	
R	79-81	TOWN & COUNTRY Todos	
R	76-80	DODGE ASPEN Todos	
R	77-78	CHARGER Todos	
R	77-82	DART	
R	77-89	DIPLOMAT Todos	
R	80-82	MAGNUM	
R	78-79	MAGNUM Todos	
R	80-83	MIRADA Todos	
R	77-78	MONACO Todos	
R	79-81	ST. REGIS Todos	
R	88-89	PLYMOUTH CARAVELLE 4x2 Tracción trasera	
R	78-81	CARAVELLE 4x2 Tracción trasera	
R	77-78	FURY Todos	
R	80-89	GRAN FURY Todos	
R	81-82	VOLARE	
R	76-80	VOLARE Todos	
81340	D		141041
R	70-74	AMERICAN MOTORS AMBASSADOR Todos	
R	70-75	AMX	
R	80-88	EAGLE Todos	
R	70-74	JAVELIN Todos	
R	71-78	MATADOR Todos	
R	76-87	CHEVROLET CHEVETTE Todos	
R	83-89	ISUZU IMPULSE Todos	
R	72	NISSAN 510 Todos	
R	74-77	710 Hardtop	
R	74-77	710 Sedan	
R	65-88	DATSUN	
R	65-68	NISSAN SEDAN	
R	76-87	PONTIAC ACADIAN Todos	
R	81-87	T1000 Todos	
R	76-79	TOYOTA COROLLA Coupe	
R	72-79	COROLLA Sedan	
R	75-78	COROLLA Hardtop	
R	72-74	COROLLA Coupe	
R	79-81	CORONA Wagon	
R	73-76	CORONA Sedan	
R	73-74	CORONA Hardtop	
R	72	CORONA Mark II Exc. Wagon	
R	78-80	CRESSIDA Wagon	
F	75-79	LAND CRUISER FJ55 (Código plataforma del fabricante), Sport Utility	
F	69-74	LAND CRUISER Todos	
81342	W		141184
R	81-93	DODGE PICKUP 1/2 TON, W100 SERIES Todos Exc. Kit de Levantamiento	

Lista numérica

Amort.	POP	No. Alternativo	Montaje Accesorio
Pos.	Año	Aplicación	
81342	W	-continued	
R	72-80	PICKUP 1/2 TON, W100 SERIES Todos	
R	81-93	PICKUP 1 TON, W300 SERIES Todos Exc. Suspensión Quad y Kit de Levantamiento	
R	72-80	PICKUP 1 TON, W300 SERIES Todos	
R	90-93	PICKUP 3/4 TON, W200 SERIES Extended Cab Pickup Exc. Kit de Levantamiento	
R	88-93	PICKUP 3/4 TON, W200 SERIES Cab & Chassis Exc. Kit de Levantamiento	
R	81-93	PICKUP 3/4 TON, W200 SERIES Standard Cab Pickup Exc. Kit de Levantamiento	
R	86	PICKUP 3/4 TON, W200 SERIES Cab & Chassis Exc. Kit de Levantamiento	
R	81-83	PICKUP 3/4 TON, W200 SERIES Cab & Chassis Exc. Kit de Levantamiento	
R	81-82	PICKUP 3/4 TON, W200 SERIES Extended Cab Pickup Exc. Kit de Levantamiento	
R	72-80	PICKUP 3/4 TON, W200 SERIES Todos	
R	76-93	RAMCHARGER 4x4	
R	78-80	RD200 Todos	
R	76-81	PLYMOUTH TRAILDUSTER 4x4	
81394	C		140780
F	85-91	FORD B200	
F	78-79	BRONCO Todos Suspensión Quad; detrás del Eje Delantero; Exc. Kit de Levantamiento	
F	67-77	BRONCO Todos Desde Serie #830001; Exc. Kit de Levantamiento	
F	66	BRONCO Todos Exc. Kit de Levantamiento	
F	75-79	PICKUP 1/2 TON, F-100 4x2 Tracción trasera	
F	75-79	PICKUP 1/2 TON, F-150 4x2 Tracción trasera	
F	75-79	PICKUP 1 TON, F-350 / SUPERDUTY 4x2 Tracción trasera	
F	75-79	PICKUP 3/4 TON, F-250 / SUPERDUTY 4x2 Tracción trasera	
F	75-91	VAN 1 TON, ECONOLINE / CLUB WAGON / SUPERDUTY Todos Exc. Conversión Motorhome	
F	75-91	VAN 3/4 TON, ECONOLINE / CLUB WAGON / SUPERDUTY Todos	
R	12	VOLKSWAGEN JETTA Sedan A4 Sedan exc. TDI	
R	06-09	JETTA Sedan A4 Sedan exc. TDI	
81406	D		
F	80-83	CHRYSLER CORDOBA Todos	
F	77-82	DART	
F	83-89	FIFTH AVENUE Todos	
F	81-83	IMPERIAL Todos	
F	74-75	IMPERIAL Todos	
F	77-82	LEBARON Todos	
F	77-82	MAGNUM	
F	74-78	NEWPORT Todos	
F	74-82	NEW YORKER Todos	
F	74-78	TOWN & COUNTRY Todos	
F	76-80	DODGE ASPEN Todos	
F	77-82	DART	
F	77-89	DIPLOMAT Todos	
F	80-82	MAGNUM	
F	80-83	MIRADA Todos	
F	74-76	MONACO Todos	
F	75-77	ROYAL MONACO Todos	
F	85-89	PLYMOUTH CARAVELLE Todos	
F	78-81	CARAVELLE 4x2 Tracción trasera	
F	82-89	GRAN FURY Todos	
F	74-77	GRAN FURY Todos	
F	81	VALIANT	
F	77-79	VALIANT SUPER BEE	
F	76-80	VOLARE Todos	
81416	D		141045
R	78-85	TOYOTA CELICA Todos	
R	75-83	COROLLA Wagon	
R	74	COROLLA Wagon Fab. desde 8/74	
R	79-82	CORONA Hatchback	
R	79-82	CORONA Sedan	
R	81-87	CRESSIDA Wagon	
81438	W		141184
R	75-80	BUICK SKYHAWK Todos	
R	75-80	CHEVROLET MONZA Todos	
R	72-77	VEGA Todos	

Lista numérica

Amort.	POP	No. Alternativo	Montaje Accesorio
Pos.	Año	Aplicación	
81438	W	-continued	141184
R	75-80	OLDSMOBILE	STARFIRE Todos
R	75-77	PONTIAC	ASTRE Todos
R	76-80	SUNBIRD	Todos
81440	D		141045
R	85-88	TOYOTA	CRESSIDA Sedan Exc. Suspensión Electrónica Ajustable
R	83-84	CRESSIDA	Sedan
R	81-82	CRESSIDA	Sedan Exc. Suspensión Electrónica Ajustable
R	78-80	CRESSIDA	Sedan
R	81-84	STARLET	Todos
81445	W		141073
F	79-85	BUICK	RIVIERA Todos
F	79-85	CADILLAC	ELDORADO Todos
F	80-85	SEVILLE	Todos
F	79-85	OLDSMOBILE	TORONADO Todos
81446	B		141041
F	71-73	BUICK	CENTURION Todos
F	71-84	ELECTRA	Todos
F	71-83	ESTATE WAGON	Todos
F	71-85	LESABRE	Todos
F	71-78	RIVIERA	Todos
F	92-96	ROADMASTER	Todos
F	91	ROADMASTER	Wagon
F	87-92	CADILLAC	BROUGHAM Todos
F	92-96	COMMERCIAL CHASSIS	4x2 Tracción trasera
F	77-84	COMMERCIAL CHASSIS	Todos
F	77-84	DEVILLE	Todos
F	93-96	FLEETWOOD	4x2 Tracción trasera
F	77-86	FLEETWOOD	4x2 Tracción trasera
F	81	CHEVROLET	BEL AIR Todos
F	71-75	BEL AIR	Sedan
F	65-70	BEL AIR	Todos
F	65-72	BISCAYNE	Todos Exc. Modelos Policía y Taxi
F	69-72	BROOKWOOD	Todos
F	70-81	CAMARO	Todos
F	91-96	CAPRICE	Todos Exc. Modelos Policía y Taxi
F	73-90	CAPRICE	Wagon Exc. Modelos Policía y Taxi
F	71-72	CAPRICE	Hardtop Exc. Modelos Policía y Taxi
F	70	CAPRICE	Hardtop
F	66-69	CAPRICE	Todos
F	94-96	IMPALA	Todos Exc. Modelos Policía y Taxi
F	65-85	IMPALA	Todos Exc. Modelos Policía y Taxi
F	69-72	KINGSWOOD	Todos
F	69-72	TOWNSMAN	Todos
F	65-74	FORD	COUNTRY SEDAN Todos
F	87-91	COUNTRY SQUIRE	Todos
F	65-74	COUNTRY SQUIRE	Todos
F	93-02	CROWN VICTORIA	Base Exc. Modelos Policía y Taxi
F	93-02	CROWN VICTORIA	LX Exc. Modelos Policía y Taxi
F	93-02	CROWN VICTORIA	S Exc. Modelos Policía y Taxi
F	02	CROWN VICTORIA	LWB Exc. Modelos Policía y Taxi
F	92	CROWN VICTORIA	Todos Exc. Modelos Policía y Taxi
F	65-72	CUSTOM	Todos
F	68-77	CUSTOM	500 Todos
F	75-76	GALAXIE	
F	65-67	GALAXIE	Todos
F	68-74	GALAXIE	500 Todos
F	84-94	GHIA	
F	95-02	GRAND MARQUIS	Todos
F	87-91	LTD / COUNTRY SEDAN / COUNTRY SQUIRE / CROWN VICTORIA	Todos
F	85-86	LTD / COUNTRY SEDAN / COUNTRY SQUIRE / CROWN VICTORIA	Crown Victoria
F	67-82	LTD / COUNTRY SEDAN / COUNTRY SQUIRE / CROWN VICTORIA	Todos
F	77-79	LTD II	Todos
F	72-79	RANCHERO	Todos
F	65-74	RANCH WAGON	Todos
F	67-79	THUNDERBIRD	Todos
F	72-76	TORINO	Todos
F	70-80	LINCOLN	CONTINENTAL Todos
F	68-71	MARK III	Todos
F	72-76	MARK IV	Todos
F	77-79	MARK V	Todos
F	80-83	MARK VI	Todos

Amortiguadores Guardian

Amort.	POP	No. Alternativo	Montaje Accesorio
Pos.	Año	Aplicación	
81446	B	-continued	141041
F	81-02	TOWN CAR	Todos
F	67	MERCURY	BROUGHAM Todos
F	87-91	COLONY PARK	Todos
F	65-74	COLONY PARK	Todos
F	65-68	COMMUTER	Todos
F	74-79	COUGAR	Todos
F	75-02	GRAND MARQUIS	Todos
F	69-70	MARAUDER	Todos
F	65-67	MARAUDER	Todos
F	67-82	MARQUIS	Todos
F	65-68	MONTCLAIR	Todos
F	72-76	MONTEGO	Todos
F	65-74	MONTEREY	Todos
F	65-68	PARKLANE	Todos
F	65-67	VILLAGER	Todos
F	66-67	VOYAGER	Todos
F	71-85	OLDSMOBILE	88 SERIES Todos
F	71-84	98	Todos
F	71-92	CUSTOM CRUISER	Todos
F	71-81	PONTIAC	BONNEVILLE Todos
F	71-81	CATALINA	Todos
F	70-81	FIREBIRD	Todos
F	71-78	GRAND SAFARI	Todos
F	76-81	LAURENTIAN	Todos
F	76-86	PARISIENNE	Todos
F	87-89	SAFARI	Todos
81450	D		
R	80-87	SUBARU	BRAT Todos
R	80-84	DL	Todos
R	85-89	GL Hatchback	
R	80-84	GL	Todos
81459	C		
R	82-89	CHRYSLER	DART
R	84-93	DAYTONA	Todos
R	83-84	E CLASS	Todos
R	85	EXECUTIVE LIMOUSINE	Todos
R	83-84	EXECUTIVE SEDAN	Todos
R	90-93	FIFTH AVENUE	
R	90-93	IMPERIAL	Todos Exc. Sistema de Autonivelación NIVOMAT
R	84-86	LASER	Todos
R	82-95	LEBARON	Todos
R	81	LEBARON	Todos Exc. M Body
R	82-89	MAGNUM	K
R	88-93	NEW YORKER	Todos Exc. Sistema de Autonivelación NIVOMAT
R	83-87	NEW YORKER	Todos
R	86-94	PHANTOM	
R	88-94	SHADOW	
R	89-95	SPIRIT RT	
R	86-88	TOWN & COUNTRY	Todos
R	86-89	VOLARE	
R	82-83	DODGE	400 Todos
R	87-88	600	Todos
R	86	600	Todos Fab. hasta 2/86
R	83-85	600	Todos
R	81-89	ARIES	Todos
R	82-89	DART	K
R	92-93	DAYTONA	Iroc R/T
R	91-93	DAYTONA	Iroc
R	89-93	DAYTONA	ES
R	89-90	DAYTONA	ES Turbo
R	87-88	DAYTONA	Pacifica
R	86	DAYTONA	Turbo Z
R	84-85	DAYTONA	Turbo
R	85-89	LANCER	Todos
R	83-88	MAGNUM	K
R	87-94	SHADOW	Todos
R	89-95	SPIRIT	Todos
R	89-95	PLYMOUTH	ACCLAIM Todos
R	88	CARAVELLE	4x2 Tracción delantera
R	83-87	CARAVELLE	Todos
R	81-89	RELIANT	Todos
R	87-94	SUNDANCE	Todos
R	82-88	VOLARE	K
81460	D		141282
R	78-83	FORD	FAIRMONT Todos
R	81-82	GRANADA	Todos
R	83-86	LTD / COUNTRY SEDAN / COUNTRY SQUIRE / CROWN VICTORIA	Todos
R	87-93	MUSTANG / MUSTANG II	LX, 2.3L 4Cyl L (140)
R	84-86	MUSTANG / MUSTANG II	LX Exc. Modelos GT y SVO
R	84	MUSTANG / MUSTANG II	L Exc. Modelos GT y SVO
R	83	MUSTANG / MUSTANG II	GL
R	83	MUSTANG / MUSTANG II	GLX Exc. Modelos Turbo GT y GT

Lista numérica

Amort.	POP	No. Alternativo	Montaje Accesorio
Pos.	Año	Aplicación	
81460	D	-continued	141282
R	83	MUSTANG / MUSTANG II	L Exc. Modelos Turbo GT y GT
R	82	MUSTANG / MUSTANG II	Ghia Exc. Modelos Base y GT
R	82	MUSTANG / MUSTANG II	GL Exc. Modelos Base y GT
R	82	MUSTANG / MUSTANG II	GLX Exc. Modelos Base y GT
R	82	MUSTANG / MUSTANG II	L Exc. Modelos Base y GT
R	79-81	MUSTANG / MUSTANG II	Todos
R	79-86	MERCURY	CAPRI Todos
R	81-82	COUGAR	Base
R	82	COUGAR	GS
R	82	COUGAR	LS
R	83-86	MARQUIS	Todos
R	78-83	ZEPHYR	Todos
81461	D		140126
R	90-91	FORD	COUGAR
R	87-88	THUNDERBIRD	Non-ABS
R	80-86	THUNDERBIRD	Todos
R	82-87	LINCOLN	CONTINENTAL Todos
R	84-92	MARK VII	Todos
R	83-88	MERCURY	COUGAR Todos
R	80-82	COUGAR	XR-7
81464	D		
R	84-91	DODGE	COLT Vista, Wagon, 4x2 Tracción delantera
R	79-83	COLT	Hatchback
R	89-91	EAGLE	VISTA Wagon, 4x2 Tracción delantera
R	86-94	HYUNDAI	EXCEL Todos
R	84-87	PONY	Todos
R	91-95	SCOUPÉ	Todos
R	83-88	MITSUBISHI	CORDIA Todos
R	90-94	PRECIS	Todos
R	83-88	TREDIA	Todos
R	79-82	PLYMOUTH	CHAMP Todos
R	92-94	COLT	Sedan
R	92	COLT	Hatchback, 4x2 Tracción delantera
R	84-91	COLT	Vista, Wagon, 4x2 Tracción delantera
R	80-83	COLT	Hatchback
81469	D		
R	57-64	CHRYSLER	300 Todos
R	57-66	IMPERIAL	Todos
R	55	IMPERIAL	Todos
R	55-56	NASSAU	Todos
R	51-64	NEWPORT	Todos
R	51-64	NEW YORKER	Todos
R	57-60	SARATOGA	Todos
R	51-52	SARATOGA	Todos
R	55-56	ST REGIS	Todos
R	51-64	TOWN & COUNTRY	Todos
R	51-61	WINDSOR	Todos
R	62-64	DODGE	880 Todos
R	51-59	CORONET	Todos
R	54-61	CUSTOM	Todos
R	63-76	DART	Todos
R	60-61	DART	Todos
R	61-62	LANCER	Todos
R	51-54	MEADOWBROOK	Todos
R	60-61	POLARA	Todos
F	64-70	VAN 1/2 TON, A / B SERIES / RAM	Van
R	64-70	VAN 1/2 TON, A / B SERIES / RAM	Van
R	58-59	EDSEL	CORSAIR Todos Exc. Wagon
R	58-59	RANGER	Todos Exc. Wagon
R	58-59	VILLAGER	Todos Exc. Wagon
R	64-69	PLYMOUTH	BARRACUDA Todos
R	53-61	BELVEDERE	Todos
R	51-53	CAMBRIDGE	Todos
R	51-52	CONCORD	Todos
R	51-53	CRANBROOK	Todos
R	58-61	CUSTOM	Todos
R	70-76	DUSTER	Todos
R	60-61	FLEET SPECIAL	Todos
R	56-61	FURY	Todos
R	54-58	PLAZA	Todos
R	53-61	SAVOY	Todos
R	71-76	SCAMP	Todos
R	60-61	SPORT WAGON	Todos
R	51-61	SUBURBAN	Todos
R	81	VALIANT	
R	60-76	VALIANT	Todos
R	74-76	VALIANT	DUSTER
R	73-79	VALIANT	SUPER BEE
R	69-71	VALIANT	SUPER BEE

Lista numérica

Amort.	POP	No. Alternativo	Montaje Accesorio
Pos.	Año	Aplicación	
81478	A		140857
F	97	CHEVROLET LUV PICKUP Todos	
F	81-82	LUV PICKUP 4x2 Tracción trasera	
F	81-95	ISUZU PICKUP 4x2 Tracción trasera	
F	69-72	NISSAN 521 PICKUP Todos	
F	72-79	620 PICKUP Todos	
F	80-86	720 PICKUP Todos	
F	65-12	PICKUP	
81481	D		142261
R	82-02	CHEVROLET CAMARO Todos	
R	98-01	FIREBIRD TRANS AM	
R	94-96	FIREBIRD TRANS AM	
R	82-02	PONTIAC FIREBIRD Todos	
81482	A		
R	05	CHEVROLET BLAZER Base, 4x4	
R	05	BLAZER Base, 4x2 Tracción trasera	
R	96-04	BLAZER LS, 4x4	
R	96-04	BLAZER LS, 4x2 Tracción trasera	
R	95-02	BLAZER LT, 4x2 Tracción trasera	
R	95-01	BLAZER LT, 4x4	
R	95-99	BLAZER Base, 4x4	
R	95-99	BLAZER Base, 4x2 Tracción trasera	
R	95-97	BLAZER Deluxe, 4x2 Tracción trasera	
R	83-94	BLAZER, S MODELS Todos	
R	98-04	S10 LS, 4x4	
R	99-03	S10 Base, 4x4	
R	99-03	S10 LS, 4x2 Tracción trasera	
R	98-03	S10 Base, 4x2 Tracción trasera	
R	94-97	S10 LS	
R	82-97	S10 Base	
R	92-93	S10 EL	
R	83-92	S10 Tahoe	
R	88-90	S10 Durango	
R	82-86	S10 Durango	
R	92-05	GMC JIMMY Todos	
R	83-91	S15 JIMMY Todos	
R	82-04	SONOMA / S15 Todos	
R	91	SYCLONE Todos	
R	92-93	TYPHOON Todos	
R	98-00	ISUZU HOMBRE Todos	
R	96-97	HOMBRE 4x2 Tracción trasera	
R	96-01	OLDSMOBILE BRAVADA Todos	
R	91-94	BRAVADA Todos	
81484	D		141137
R	73-74	FORD B100	
R	78-79	BRONCO Todos Exc. Kit de Levantamiento	
R	66-77	BRONCO Todos Desde Serie #830001; Exc. Kit de Levantamiento	
R	65-78	F-100	
R	67-78	F-350 PICKUP	
R	75-79	PICKUP 1 TON, F-350 / SUPERDUTY Standard Cab Pickup, 4x2 Tracción trasera	
R	75-79	PICKUP 3/4 TON, F-250 / SUPERDUTY Extended Cab Pickup, 4x2 Tracción trasera	
R	69-74	VAN 1/2 TON, ECONOLINE / CLUB WAGON Todos	
R	69-74	VAN 1 TON, ECONOLINE / CLUB WAGON / SUPERDUTY Todos	
R	69-74	VAN 3/4 TON, ECONOLINE / CLUB WAGON / SUPERDUTY Todos	
R	76-83	JEEP CHEROKEE Todos	
F	74-83	CHEROKEE Todos	
F	82-83	CJ5 Todos Exc. Kit de Levantamiento	
F	82-86	CJ5D	
F	82-86	CJ7	
F	82-86	CJ7 Todos	
F	82-86	CJ7 Todos Exc. Kit de Levantamiento	
F	84-85	CJ10	
R	67	GLADIATOR Todos	
F	84-91	GRAND WAGONEER Todos	
R	84-91	GRAND WAGONEER Todos	
F	74-88	J10 PICKUP Todos	
R	74-88	J10 PICKUP Todos	
F	74-88	J20 PICKUP Todos	
R	74-88	J20 PICKUP Todos	
F	74-86	J164	
F	74-86	J164V	
F	74-84	J364R	
R	68-73	J2500 PICKUP Todos	
F	82-85	SCRAMBLER / CJ8 Todos	
R	76-83	WAGONEER Todos	
F	74-83	WAGONEER Todos	
81490	A		140780
F	82-85	FORD B150	
F	92	B200	
F	97	BRONCO	

Amortiguadores Guardian

Amort.	POP	No. Alternativo	Montaje Accesorio
Pos.	Año	Aplicación	
81490	A	-continued	140780
F	80-96	BRONCO Todos Con o sin Suspensión Quad detrás del Eje Delantero; Exc. Kit de Levantamiento	
F	89	BRONCO II Todos Fab. hasta 2/89; Vehículos con perno 10mm y 12mm en montaje inferior trasero	
F	84-88	BRONCO II Todos Con Perno de 10mm en Montaje Inferior Trasero	
F	86-90	F-200	
F	86-97	P350 MICROBUS	
F	80-83	PICKUP 1/2 TON, F-100 4x2 Tracción trasera	
F	80-96	PICKUP 1/2 TON, F-150 4x4 Con o sin Suspensión Quad detrás del Eje Delantero; Exc. Kit de Levantamiento	
F	80-96	PICKUP 1/2 TON, F-150 4x2 Tracción trasera	
F	99-00	PICKUP 1 TON, F-350 / SUPERDUTY 4x2 Tracción trasera	
F	80-97	PICKUP 1 TON, F-350 / SUPERDUTY 4x2 Tracción trasera	
F	97	PICKUP 3/4 TON, F-250 / SUPERDUTY 4x2 Tracción trasera PBV arriba de 8500#	
F	80-96	PICKUP 3/4 TON, F-250 / SUPERDUTY 4x2 Tracción trasera	
F	87-89	RANGER Todos Exc. Opción High Ryder	
F	83-86	RANGER Todos	
F	02-06	NISSAN URVAN Todos	
81491	D		141164
F	80-88	AMERICAN MOTORS EAGLE Todos	
F	75-80	FORD GRANADA Todos	
F	73	MUSTANG	
F	71-73	MUSTANG / MUSTANG II Todos	
F	77-80	LINCOLN VERSAILLES Todos	
F	71-73	MERCURY COUGAR Todos	
F	75-80	MONARCH Todos	
81492	D		140629
R	73-81	BUICK CENTURY Todos	
R	71-83	ESTATE WAGON Todos	
R	65-67	GRAN SPORT Todos	
R	68-72	GS / GS350 / GS400 / GS455 Todos	
R	73-87	REGAL Todos	
R	91-96	ROADMASTER Wagon	
R	68-72	SKYLARK Todos	
R	64-67	SKYLARK Todos Suspensión HD Exc. Sportwagon	
R	68-69	SPECIAL Todos	
R	64-67	SPECIAL Todos Suspensión HD Exc. Sportwagon	
R	70-72	SPORTWAGON Todos	
R	71-72	CHEVROLET BROOKWOOD Todos	
R	71-96	CAPRICE Wagon	
R	68-73	CHEVELLE Todos	
R	64-67	CHEVELLE Todos Suspensión HD	
R	68-87	EL CAMINO Todos	
R	71-82	IMPALA Wagon	
R	71-72	KINGSWOOD Todos	
R	73-83	MALIBU Todos	
R	64-67	MALIBU Todos Suspensión HD	
R	70-88	MONTE CARLO Todos	
R	71-72	TOWNSMAN Todos	
R	78-87	GMC SPRINT / CABALLERO 4x2 Tracción trasera	
R	71-77	SPRINT / CABALLERO Todos	
R	73-76	NISSAN 610 Wagon	
R	74-77	710 Wagon	
R	77-80	810 Wagon	
R	73-83	STATION WAGON	
R	71-92	OLDSMOBILE CUSTOM CRUISER Todos	
R	68-87	CUTLASS / CUTLASS SUPREME Todos	
R	72	CUTLASS / CUTLASS SUPREME Base	
R	72	CUTLASS / CUTLASS SUPREME S Todos Suspensión HD	
R	64-67	CUTLASS / CUTLASS SUPREME Todos Suspensión HD	
R	80-83	CUTLASS CLASSIC / CUTLASS CRUISER Todos	
R	68-72	F85 Todos	
R	64-67	F85 Todos Suspensión HD	
R	71-78	TORONADO Todos	
R	82-86	PONTIAC BONNEVILLE Todos	
R	77-81	CATALINA Wagon	
R	71-75	CATALINA Wagon	
R	78-80	GRAND AM Todos	
R	73-75	GRAND AM Todos	

Lista numérica

Amort.	POP	No. Alternativo	Montaje Accesorio
Pos.	Año	Aplicación	
81492	D	-continued	140629
R	75-83	GRAND LEMANS Todos	
R	69-87	GRAND PRIX Todos	
R	71-78	GRAND SAFARI Todos	
R	71-75	GRANDVILLE Todos	
R	68-73	GTO Todos	
R	64-67	GTO Todos Suspensión HD	
R	68-81	LEMANS Todos	
R	64-67	LEMANS Todos Suspensión HD	
R	80-86	PARISIENNE Wagon	
R	76-79	PARISIENNE Todos Wagon	
R	87-89	SAFARI Todos	
R	68-70	TEMPEST Todos	
R	64-67	TEMPEST Todos Suspensión HD	
81494	D		140455
F	73-75	BUICK APOLLO Todos	
F	73-81	CENTURY Todos	
F	68-72	GS / GS350 / GS400 / GS455 Todos	
F	73-87	REGAL Todos	
F	75-79	SKYLARK Todos	
F	68-72	SKYLARK Todos	
F	68-69	SPECIAL Todos	
F	68-72	SPORTWAGON Todos	
F	76-79	CADILLAC SEVILLE Todos	
F	67-69	CHEVROLET CAMARO Todos	
F	68-73	CHEVELLE Todos	
F	68	CHEVY II Todos	
F	73-83	MALIBU Todos	
F	70-88	MONTE CARLO Todos	
F	69-79	NOVA Todos	
F	64-65	NISSAN 410 Todos	
F	64-67	411 Todos	
F	65-88	DATSUN	
F	65-68	NISSAN SEDAN	
F	65-71	STATION WAGON	
F	68-87	OLDSMOBILE CUTLASS / CUTLASS SUPREME Todos	
F	80-83	CUTLASS CLASSIC / CUTLASS CRUISER Todos	
F	68-72	F85 Todos	
F	74-79	OMEGA Todos	
F	73	OMEGA Todos Exc. Suspensión HD	
F	82-86	PONTIAC BONNEVILLE Todos	
F	67-69	FIREBIRD Todos	
F	78-80	GRAND AM Todos	
F	73-75	GRAND AM Todos	
F	75-83	GRAND LEMANS Todos	
F	69-87	GRAND PRIX Todos	
F	71-75	GRANDVILLE Todos	
F	68-73	GTO Todos	
F	68-81	LEMANS Todos	
F	77-79	PHOENIX Todos	
F	68-70	TEMPEST Todos	
F	71-77	VENTURA Todos	
F	69-78	TOYOTA CORONA Todos	
F	68-75	VOLVO 142 / 144 / 145 / 164 Todos	
81495	C		141150
R	61-63	BUICK SKYLARK Todos	
R	61-63	SPECIAL Todos	
R	64-69	SPORTWAGON Todos	
R	68-69	CHEVROLET CAMARO Todos Resorte Trasero de Hojas Múltiples	
R	65-74	FORD COUNTRY SEDAN Todos	
R	87-91	COUNTRY SQUIRE Todos	
R	65-74	COUNTRY SQUIRE Todos	
R	92-02	CROWN VICTORIA Todos	
R	65-72	CUSTOM Todos	
R	68-77	CUSTOM 500 Todos	
R	66-70	FALCON Todos Wagon	
R	75-76	GALAXIE	
R	65-67	GALAXIE Todos	
R	68-74	GALAXIE 500 Todos	
R	84-94	GHIA	
R	95-02	GRAND MARQUIS Todos	
R	87-91	LTD / COUNTRY SEDAN / COUNTRY SQUIRE / CROWN VICTORIA Todos	
R	67-82	LTD / COUNTRY SEDAN / COUNTRY SQUIRE / CROWN VICTORIA Todos	
R	77-79	LTD II Todos	
R	66-79	RANCHERO Todos	
R	65-74	RANCH WAGON Todos	
R	77-79	THUNDERBIRD Todos	
R	67-72	THUNDERBIRD Todos	
R	74-76	TORINO Wagon	
R	71	TORINO Wagon	
R	70-80	LINCOLN CONTINENTAL Todos	
R	68-71	MARK III Todos	
R	72	MARK IV Todos	
R	80-83	MARK VI Todos	
R	81-02	TOWN CAR Todos	
R	67	MERCURY BROUGHAM Todos	

Lista numérica

Amort.	POP	No. Alternativo	Montaje Accesorio
Pos.	Año	Aplicación	
81495	C	-continued	141150
R	87-91	COLONY PARK Todos	
R	65-74	COLONY PARK Todos	
R	66-67	COMET Wagon	
R	65-68	COMMUTER Todos	
R	74-79	COUGAR Todos	
R	75-02	GRAND MARQUIS Todos	
R	69-70	MARAUDER Todos	
R	65-67	MARAUDER Todos	
R	67-82	MARQUIS Todos	
R	65-68	MONTCLAIR Todos	
R	74-76	MONTEGO Wagon	
R	68-73	MONTEGO Todos Wagon	
R	65-74	MONTEREY Todos	
R	65-68	PARKLANE Todos	
R	65-67	VILLAGER Todos	
R	66-67	VOYAGER Todos	
R	64-72	OLDSMOBILE VISTA CRUISER Todos Montaje Superior de Espiga	
R	68-69	PONTIAC FIREBIRD Todos	
81496	C		
F	87-91	CHEVROLET BLAZER 4x4 Automóvil Grande; Suspensión Quad Amortiguador Largo; Exc. Kit de Levantamiento	
F	81-86	BLAZER 4x4 Suspensión Quad Amortiguador Largo; Exc. Kit de Levantamiento	
F	81-86	PICKUP 1/2 TON, K10 Todos Suspensión Quad Amortiguador Largo; Exc. Kit de Levantamiento	
F	87	PICKUP 1/2 TON, V10 Todos Suspensión Quad Amortiguador Largo; Exc. Kit de Levantamiento	
F	81-86	PICKUP 3/4 TON, K20 Todos Suspensión Quad Amortiguador Largo; Exc. Kit de Levantamiento	
F	87	PICKUP 3/4 TON, V20 Todos Suspensión Quad Amortiguador Largo; Exc. Kit de Levantamiento	
F	81-86	SUBURBAN 1/2 TON, K10 Todos Suspensión Quad Amortiguador Largo; Exc. Kit de Levantamiento	
F	87-88	SUBURBAN 1/2 TON, V10 Todos Suspensión Quad Amortiguador Largo; Exc. Kit de Levantamiento	
F	81-86	SUBURBAN 3/4 TON, K20 Todos Suspensión Quad Amortiguador Largo; Exc. Kit de Levantamiento	
F	87-88	SUBURBAN 3/4 TON, V20 Todos Suspensión Quad Amortiguador Largo; Exc. Kit de Levantamiento	
F	89-91	SUBURBAN 3/4 TON, V2500 Todos Suspensión Quad Amortiguador Largo; Exc. Kit de Levantamiento	
R	78-95	VAN 1/2 TON, G / EXPRESS Todos	
R	78-95	VAN 1 TON, G / EXPRESS Cutaway Van	
R	78-95	VAN 3/4 TON, G / EXPRESS Todos Exc. PBV 8600 #	
R	84-86	DODGE MINI RAM Todos	
R	99-03	VAN 1/2 TON, A / B SERIES / RAM 109.3 (WheelBase) Exc. PBV 7000#	
R	81-98	VAN 1/2 TON, A / B SERIES / RAM 109.6 (WheelBase) Exc. PBV 7000#	
R	71-80	VAN 1/2 TON, A / B SERIES / RAM Todos	
R	99-03	VAN 1 TON, A / B SERIES / RAM Todos	
R	95-98	VAN 1 TON, A / B SERIES / RAM Todos Exc. Eje Delantero 4000#	
R	71-94	VAN 1 TON, A / B SERIES / RAM Todos	
R	71-03	VAN 3/4 TON, A / B SERIES / RAM Todos	
R	74-80	VAN, CB300 Todos	
F	73-91	GMC JIMMY 4x4 Suspensión Quad Amortiguador Largo; Exc. Kit de Levantamiento	
F	81-86	PICKUP 1/2 TON, K15 / K1500 Todos Suspensión Quad Amortiguador Largo; Exc. Kit de Levantamiento	
F	87	PICKUP 1/2 TON, V1500 Todos Suspensión Quad Amortiguador Largo; Exc. Kit de Levantamiento	
F	87-88	PICKUP 1 TON, V3000 / V3500 Todos Suspensión Quad Amortiguador Largo; Exc. Kit de Levantamiento	
F	81-86	PICKUP 3/4 TON, K25 / K2500 Todos Suspensión Quad Amortiguador Largo; Exc. Kit de Levantamiento	

Amortiguadores Guardian

Amort.	POP	No. Alternativo	Montaje Accesorio
Pos.	Año	Aplicación	
81496	C	-continued	
F	87	PICKUP 3/4 TON, V2500 Todos Suspensión Quad Amortiguador Largo; Exc. Kit de Levantamiento	
F	81-86	SUBURBAN 1/2 TON, K15 / K1500 Todos Suspensión Quad Amortiguador Largo; Exc. Kit de Levantamiento	
F	87-91	SUBURBAN 1/2 TON, V1500 Todos Suspensión Quad Amortiguador Largo; Exc. Kit de Levantamiento	
F	81-86	SUBURBAN 3/4 TON, K25 / K2500 Todos Suspensión Quad Amortiguador Largo; Exc. Kit de Levantamiento	
F	87-91	SUBURBAN 3/4 TON, V2500 Todos Suspensión Quad Amortiguador Largo; Exc. Kit de Levantamiento	
R	78-95	VAN 1/2 TON, G / SAVANNA Todos	
R	85-96	VAN 1 TON, G / SAVANNA Extended Cargo Van	
R	85-96	VAN 1 TON, G / SAVANNA Extended Passenger Van	
R	79-96	VAN 1 TON, G / SAVANNA Standard Cargo Van	
R	79-96	VAN 1 TON, G / SAVANNA Standard Passenger Van	
R	78	VAN 1 TON, G / SAVANNA Cutaway Van	
R	78-95	VAN 3/4 TON, G / SAVANNA Todos Exc. PBV 8600 #	
R	74-83	PLYMOUTH VAN 1/2 TON, PB SERIES Todos	
R	74-83	VAN 1 TON, PB SERIES Todos	
R	74-83	VAN 3/4 TON, PB SERIES Todos	
81498	D		141045
R	88-91	TOYOTA COROLLA Wagon	
R	80-87	COROLLA Coupe	
R	80-83	COROLLA Hatchback	
R	80-83	COROLLA Sedan	
R	83	COROLLA Hardtop	
R	83-88	TERCEL Wagon, 4x4	
81501	D		140862
R	84	NISSAN 200SX Todos Eje Delantero Rígido	
R	77-83	200SX Todos	
R	79-82	210 Todos	
R	78-81	510 Hatchback	
R	78-81	510 Sedan	
R	71-73	1200 Todos	
R	75-78	B210 Todos Exc. Hatchback	
R	74	B210 Todos	
R	82-85	SAKURA	
R	79-84	SAMURAI	
81507	A		140857
F	81-82	CHEVROLET LUV PICKUP 4x4	
F	75-80	LUV PICKUP Todos	
F	72-74	LUV PICKUP Todos	
F	89-94	ISUZU AMIGO Todos	
F	81-95	PICKUP 4x4	
F	84-86	TROOPER Todos	
F	98-04	NISSAN FRONTIER 4x2 Tracción trasera Exc. Desert Runner	
F	65-94	PICKUP	
81508	D		140812
R	86	NISSAN PULSAR / PULSAR NX Todos Fab. desde 1/86	
R	83-85	PULSAR / PULSAR NX Todos	
R	82-86	SENTRA Todos	
R	84-87	TSURU	
81510	D		
R	65-66	FORD F-350 PICKUP	
R	80-96	PICKUP 1/2 TON, F-150 4x4 Exc. Kit de Levantamiento	
R	86-97	PICKUP 1 TON, F-350 / SUPERDUTY 4x4 Doble Rodada Trasera	
R	82-85	PICKUP 1 TON, F-350 / SUPERDUTY 4x4 Montaje Inferior Delantero Tipo Abrazadera Exc. Doble Rodado o Kit de Levantamiento	
R	80-81	PICKUP 1 TON, F-350 / SUPERDUTY 4x4 Doble Rodada Trasera	
R	97	PICKUP 3/4 TON, F-250 / SUPERDUTY 4x4 PBV arriba de 8500#	
R	86-96	PICKUP 3/4 TON, F-250 / SUPERDUTY 4x4	

Lista numérica

Amort.	POP	No. Alternativo	Montaje Accesorio
Pos.	Año	Aplicación	
81510	D	-continued	
R	82-85	PICKUP 3/4 TON, F-250 / SUPERDUTY 4x4 Montaje Inferior Delantero Tipo Abrazadera Exc. Doble Rodado o Kit de Levantamiento	
R	80-81	PICKUP 3/4 TON, F-250 / SUPERDUTY 4x4	
81514	D		140629
R	73	BUICK APOLLO Todos Suspensión HD	
R	71-73	CENTURION Todos	
R	71-84	ELECTRA Todos	
R	70	ESTATE WAGON Todos	
R	71-85	LESABRE Todos	
R	71-78	RIVIERA Todos	
R	92-96	ROADMASTER Sedan	
R	64-67	SKYLARK Todos Exc. Suspensión HD	
R	64-67	SPECIAL Todos Exc. Suspensión HD	
R	87-92	CADILLAC BROUGHAM Todos	
R	92-96	COMMERCIAL CHASSIS 4x2 Tracción trasera	
R	77-84	COMMERCIAL CHASSIS Todos	
R	77-84	DEVILLE Todos	
R	93-96	FLEETWOOD 4x2 Tracción trasera	
R	77-86	FLEETWOOD 4x2 Tracción trasera	
R	81	CHEVROLET BEL AIR Todos	
R	65-75	BEL AIR Todos	
R	65-72	BISCAYNE Todos	
R	69-70	BROOKWOOD Todos	
R	73-96	CAPRICE Sedan Modelos Policía y Taxi	
R	71-72	CAPRICE Hardtop Modelos Policía y Taxi	
R	66-70	CAPRICE Todos	
R	64-67	CHEVELLE Todos Exc. Suspensión HD	
R	68	CHEVY II Todos Resorte Trasero de Hojas Múltiples	
R	64-67	EL CAMINO Todos	
R	94-96	IMPALA Todos	
R	83-85	IMPALA Todos	
R	65-82	IMPALA Sedan	
R	74-81	IMPALA Coupe	
R	73	IMPALA Hardtop	
R	69-70	KINGSWOOD Todos	
R	64-67	MALIBU Todos Exc. Suspensión HD	
R	73	NOVA Todos Suspensión HD	
R	69-72	NOVA Todos Resorte Trasero de Hojas Múltiples	
R	69-70	TOWNSMAN Todos	
R	65-85	OLDSMOBILE 88 SERIES Todos	
R	65-84	98 Todos	
R	64-67	CUTLASS / CUTLASS SUPREME Todos Exc. Suspensión HD	
R	64-67	F85 Todos Exc. Suspensión HD	
R	65-66	STARFIRE Todos	
R	63-81	PONTIAC BONNEVILLE Todos	
R	75-81	CATALINA Coupe	
R	71-81	CATALINA Sedan	
R	71-74	CATALINA Hardtop	
R	63-70	CATALINA Todos	
R	67-70	EXECUTIVE Todos	
R	63-68	GRAND PRIX Todos	
R	64-67	GTO Todos Exc. Suspensión HD	
R	76-81	LAURENTIAN Todos	
R	64-67	LEMANS Todos Exc. Suspensión HD	
R	76-86	PARISIENNE Sedan	
R	63-66	STAR CHIEF Todos	
R	64-67	TEMPEST Todos Exc. Suspensión HD	
R	73	VENTURA Todos Suspensión HD	
R	71-72	VENTURA Todos Resorte Trasero de Hojas Múltiples	
81516	B		
F	05	CHEVROLET BLAZER Base, 4x4	
F	96-04	BLAZER LS, 4x4	
F	95-01	BLAZER LT, 4x4	
F	95-99	BLAZER Base, 4x4	
F	83-94	BLAZER, S MODELS 4x4	
F	94-04	S10 LS, 4x4	
F	83-03	S10 Base, 4x4	
F	92-93	S10 EL, 4x4	
F	83-92	S10 Tahoe, 4x4	
F	88-90	S10 Durango, 4x4	
F	83-86	S10 Durango, 4x4	
F	92-05	GMC JIMMY 4x4	
F	83-91	S15 JIMMY 4x4	
F	83-04	SONOMA / S15 4x4	
F	91	SYCLONE Todos	

Lista numérica

Amort.	POP	No. Alternativo	Montaje Accesorio
Pos.	Año	Aplicación	
81516		B	-continued
F	92-93	TYPHOON Todos	
F	99-00	ISUZU HOMBRE 4x4	
F	96-98	HOMBRE 4x2 Tracción trasera Chasis Deportivo	
F	98	HOMBRE 4x4 Chasis Deportivo	
F	96-01	OLDSMOBILE BRAVADA Todos	
F	91-94	BRAVADA Todos	
81517		C	141277
R	82-96	BUICK CENTURY Todos	
R	80-85	SKYLARK Todos	
R	82-90	CHEVROLET CELEBRITY Todos	
R	89-97	CENTURY	
R	83-86	CENTURY	
R	86-88	CITATION	
R	80-85	CITATION / CITATION II Todos	
R	86-97	CUTLASS	
R	91-96	EUROSPORT	
R	82-96	OLDSMOBILE CIERA / CUTLASS CIERA Todos Exc. Suspensión Electrónica Ajustable	
R	87-94	CUTLASS CLASSIC / CUTLASS CRUISER Todos Exc. Suspensión Electrónica Ajustable	
R	80-84	OMEGA Todos	
R	89-91	PONTIAC 6000 4x2 Tracción delantera	
R	82-88	6000 Todos	
R	80-84	PHOENIX Todos	
81529		B	
R	91-95	CHRYSLER GRAND VOYAGER	
R	90-95	TOWN & COUNTRY Todos	
R	90-94	VOYAGER	
R	84-95	DODGE CARAVAN / GRAND CARAVAN Todos	
R	87-88	MINI RAM Todos	
R	84-95	PLYMOUTH VOYAGER / GRAND VOYAGER Todos	
81530		C	141277
R	93	ASUNA GT, SE+C487 Todos	
R	93	SE Todos	
R	82-89	BUICK SKYHAWK Todos	
R	86-94	SKYLARK Todos	
R	85-87	SOMERSET / SOMERSET REGAL Todos	
R	82-88	CADILLAC CIMARRON Todos	
R	92-94	CHEVROLET BERETTA Base Exc. Suspensión FE7	
R	87-91	BERETTA Todos	
R	82-94	CAVALIER Todos	
R	87-94	CORSICA Todos	
R	92-94	OLDSMOBILE ACHIEVA Todos Exc. FE3 y Control de Manejo Electrónico	
R	85-87	CALAIS Todos	
R	88-91	CUTLASS CALAIS Todos	
R	87-88	FIRENZA Todos	
R	84-86	FIRENZA Todos Struts Reconstruibles de EO	
R	82-83	FIRENZA Todos	
R	85-94	PONTIAC GRAND AM Todos	
R	82-85	J2000 / SUNBIRD Todos	
R	86-94	SUNBIRD Todos	
R	87-91	TEMPEST Todos	
81538		D	
R	82	DODGE D50 4x4	
R	87-93	PICKUP, RAM 50 4x4	
R	83-94	MITSUBISHI MIGHTY MAX 4x4	
81539		B	
R	89	FORD BRONCO II Todos Fab. hasta 2/89; Vehículos con perno 10mm y 12mm en montaje inferior trasero	
R	84-88	BRONCO II Todos Con Perno de 10mm en Montaje Inferior Trasero	
R	89	RANGER 4x2 Tracción trasera Fab. hasta 2/89; Vehículos con perno 10mm y 12mm en montaje inferior trasero	
R	83-88	RANGER 4x2 Tracción trasera	
81540		C	
R	83-89	FORD RANGER 4x4	
81541		B	140455
F	85-95	TOYOTA PICKUP 4x2 Tracción trasera Exc. 1 Ton	
F	84	PICKUP 4x2 Tracción trasera	
F	93-98	T100 4x2 Tracción trasera	

Amortiguadores Guardian

Amort.	POP	No. Alternativo	Montaje Accesorio
Pos.	Año	Aplicación	
81542		X	140524
R	84-89	TOYOTA VAN Coil (RearSpringType)	
R	88	VAN WAGON Todos Resorte Trasero	
81548		B	141353
F	84-01	JEEP CHEROKEE Todos	
F	86-92	COMANCHE Todos	
F	92	GRAND CHEROKEE	
F	93-98	GRAND CHEROKEE Todos	
F	93	GRAND WAGONEER Todos Exc. Suspensión Up Country	
F	84-90	WAGONEER Todos	
81549		B	
R	84-01	JEEP CHEROKEE Todos	
R	84-90	WAGONEER Todos	
81553		B	140524
F	87-91	ISUZU TROOPER Todos	
F	86-87	MAZDA B2000 4x2 Tracción trasera	
F	87-93	B2200 4x2 Tracción trasera	
F	87-93	B2600 4x2 Tracción trasera	
81554		X	
R	86-88	NISSAN MULTI Todos	
R	86-88	STANZA Wagon, 4x2 Tracción delantera	
81558		D	140673
R	85-88	CHEVROLET SPECTRUM Todos	
R	89	GEO SPECTRUM Todos	
R	88-89	ISUZU I-MARK XS	
R	85-87	I-MARK Todos	
R	85-88	PONTIAC SUNBURST Todos	
81559		B	140126
F	87-04	DODGE DAKOTA 4x2 Tracción trasera	
F	99-03	DURANGO 4x2 Tracción trasera	
81560		D	
R	87-96	DODGE DAKOTA 4x2 Tracción trasera	
81581		C	
R	90-05	CHEVROLET ASTRO Todos	
R	85-89	ASTRO 4x2 Tracción trasera	
R	90-05	GMC SAFARI Todos	
R	85-89	SAFARI 4x2 Tracción trasera	
R	86-89	VOLKSWAGEN VANAGON 4x4	
81582		C	140126
F	86-97	FORD AEROSTAR 4x2 Tracción trasera	
81583		D	
R	86-88	FORD AEROSTAR 4x2 Tracción trasera	
R	87-95	JEEP WRANGLER YJ (Código plataforma del fabricante)	
81667		B	
R	92-96	CHEVROLET 400SS PICKUP	
R	96-97	BOSS TRUCK	
R	90-96	MICROBUS	
R	88-99	PICKUP 1/2 TON, C15 / C1500 Todos	
R	88-99	PICKUP 1/2 TON, K15 / K1500 Todos	
R	01-03	PICKUP 1 TON, C35/3500 Base Eje Delantero Rígido HD	
R	88-00	PICKUP 1 TON, C35/3500 Extended Cab Pickup Eje Delantero Rígido HD	
R	88-00	PICKUP 1 TON, C35/3500 Standard Cab Pickup Eje Delantero Rígido HD	
R	88-00	PICKUP 1 TON, K35 / K3500 Todos	
R	88-00	PICKUP 3/4 TON, C25 / C2500 Todos	
R	88-00	PICKUP 3/4 TON, K25 / K2500 Todos	
R	01-02	GMC C3500	
R	88-99	PICKUP 1/2 TON, C15 / C1500 Todos	
R	88-99	PICKUP 1/2 TON, K15 / K1500 Todos	
R	88-00	PICKUP 1 TON, C35/3500 Extended Cab Pickup Eje Delantero Rígido HD	
R	88-00	PICKUP 1 TON, C35/3500 Standard Cab Pickup Eje Delantero Rígido HD	
R	88-00	PICKUP 1 TON, K35 / K3500 Todos	
R	88-00	PICKUP 3/4 TON, C25 / C2500 Todos	
R	88-00	PICKUP 3/4 TON, K25 / K2500 Todos	

Lista numérica

Amort.	POP	No. Alternativo	Montaje Accesorio
Pos.	Año	Aplicación	
81668		A	141277
F	92-96	CHEVROLET 400SS PICKUP	
F	96-97	BOSS TRUCK	
F	90-96	MICROBUS	
F	88-99	PICKUP 1/2 TON, C15 / C1500 Todos	
F	92-00	PICKUP 1 TON, C35/3500 Todos Eje Delantero Rígido HD	
F	88-91	PICKUP 1 TON, C35/3500 Extended Cab Pickup Eje Delantero Rígido HD	
F	88-91	PICKUP 1 TON, C35/3500 Standard Cab Pickup Eje Delantero Rígido HD	
F	88-00	PICKUP 3/4 TON, C25 / C2500 Todos	
F	92-99	SUBURBAN 1/2 TON, C15 / C1500 Todos	
F	92-99	SUBURBAN 3/4 TON, C25 / C2500 Todos	
F	95-00	TAHOE 4x2 Tracción trasera Old Body Style	
F	88-99	GMC PICKUP 1/2 TON, C15 / C1500 Todos	
F	88-00	PICKUP 1 TON, C35/3500 Todos Eje Delantero Rígido HD	
F	88-00	PICKUP 3/4 TON, C25 / C2500 Todos	
F	92-99	SUBURBAN 1/2 TON, C15 / C1500 Todos	
F	92-99	SUBURBAN 3/4 TON, C25 / C2500 Todos	
F	92-99	YUKON 4x2 Tracción trasera	
81670		W	
F	88	PONTIAC FIERO Todos	
81671		D	141714
R	85-88	NISSAN 200SX Todos	
R	86-87	SAKURA	
81674		X	141301
R	93	FORD MUSTANG / MUSTANG II GT, 5.0L 8Cyl V (302)	
R	93	MUSTANG / MUSTANG II LX, 5.0L 8Cyl V (302)	
R	87-92	MUSTANG / MUSTANG II 5.0L 8Cyl V (302)	
R	84-86	MUSTANG / MUSTANG II SVO	
R	82-86	MUSTANG / MUSTANG II GT	
81675		D	140455
F	86-95	SUZUKI SAMURAI Todos	
81676		D	
R	77-79	DODGE COLT Coupe	
R	77-79	COLT Sedan	
R	77	COLT Hardtop	
R	55	FORD F SERIES Todos F250	
R	53-54	F SERIES Todos	
R	48-52	F SERIES Todos F-1, F-2 y F-3	
R	53	PICKUP 1/2 TON, F-100 Todos Exc. Heavy Duty	
R	74	JEEP CHEROKEE Todos	
F	66-71	CJ5 Todos Resorte Frontal de 5 Hojas Exc. Kit de Levantamiento	
R	66-71	CJ5 Todos Resorte Frontal de 5 Hojas Exc. Kit de Levantamiento	
F	65-71	CJ5D	
F	65-71	CJ5S	
F	66-71	CJ6 Todos Resorte Frontal de 5 Hojas Exc. Kit de Levantamiento	
R	66-71	CJ6 Todos Resorte Frontal de 5 Hojas Exc. Kit de Levantamiento	
F	61-67	DISPATCHER Todos	
R	61-67	DISPATCHER Todos	
R	61-65	FC150 Todos	
F	61-67	UNIVERSAL Todos Resorte Frontal de 5 Hojas Exc. Kit de Levantamiento	
R	61-67	UNIVERSAL Todos Resorte Frontal de 5 Hojas Exc. Kit de Levantamiento	
R	63-74	WAGONEER Todos	
F	63-65	WAGONEER Todos Suspensión Delantera Independiente	
R	76-80	PLYMOUTH ARROW Todos	
R	76-79	COLT Todos	
R	56-57	SAAB 93 Todos	
R	58-59	93B Todos	
R	58-59	GT750 Todos	
R	63	GT850 Todos	
R	86-95	SUZUKI SAMURAI Todos	
81691		D	141353
F	87-95	JEEP WRANGLER YJ (Código plataforma del fabricante)	

Lista numérica

Amort.	POP	No. Alternativo	Montaje Accesorio
Pos.	Año	Aplicación	
81693	W		141665,140719
R	86-14	FORD SABLE	
R	86-95	TAURUS Wagon	
R	86-95	MERCURY SABLE Wagon	
81694	D		140780
F	75-78	FORD B150	
F	75-91	VAN 1/2 TON, ECONOLINE / CLUB WAGON Todos	
81710	C		
R	82-85	FORD B150	
R	80-96	BRONCO Todos Exc. Kit de Levantamiento	
R	86-90	F-200	
R	99-00	F-350 PICKUP	
R	86-97	P350 MICROBUS	
R	80-83	PICKUP 1/2 TON, F-100 4x2 Tracción trasera	
R	80-84	PICKUP 1/2 TON, F-150 4x2 Tracción trasera	
R	90-97	PICKUP 1/2 TON, F SUPERDUTY Todos	
R	80-97	PICKUP 1 TON, F-350 / SUPERDUTY 4x2 Tracción trasera Doble Rodada Trasera	
R	10	NISSAN URVAN Todos amortiguador trasero sin buje metálico	
R	07-08	URVAN Todos amortiguador trasero sin buje metálico	
81713	B		140800
F	85-05	CHEVROLET ASTRO 4x2 Tracción trasera	
F	71-75	BEL AIR Wagon	
F	71-72	BISCAYNE Todos Modelos Policía y Taxi	
F	73-96	CAPRICE Sedan Modelos Policía y Taxi	
F	71-72	CAPRICE Hardtop Modelos Policía y Taxi	
F	83-85	IMPALA Todos Modelos Policía y Taxi	
F	71-82	IMPALA Sedan Modelos Policía y Taxi	
F	96-02	VAN 1/2 TON, G / EXPRESS Todos	
F	97-02	VAN 1 TON, G / EXPRESS Todos	
F	96-02	VAN 3/4 TON, G / EXPRESS Todos Exc. PBV 8600 #	
F	93-02	FORD CROWN VICTORIA Police Interceptor Modelos Policía y Taxi	
F	85-05	GMC SAFARI 4x2 Tracción trasera	
F	96-02	VAN 1/2 TON, G / SAVANNA 4x2 Tracción trasera	
F	96-02	VAN 1 TON, G / SAVANNA Todos	
F	96-02	VAN 3/4 TON, G / SAVANNA Todos Exc. PBV 8600 #	
81714	C		140455
F	79-82	DODGE D50 4x2 Tracción trasera	
F	87-93	PICKUP, RAM 50 4x2 Tracción trasera	
F	83-86	PICKUP, RAM 50 Todos	
F	83-96	MITSUBISHI MIGHTY MAX 4x2 Tracción trasera	
F	79-82	PLYMOUTH ARROW PICKUP Todos	
81726	C		
F	99-00	CADILLAC ESCALADE Todos	
F	90-05	CHEVROLET ASTRO AWD	
F	92-94	BLAZER 4x4 Automóvil Grande	
F	88-00	PICKUP 1 TON, K35 / K3500 Todos	
F	88-00	PICKUP 3/4 TON, K25 / K2500 Todos	
F	92-99	SUBURBAN 1/2 TON, K15 / K1500 Todos	
F	92-99	SUBURBAN 3/4 TON, K25 / K2500 Todos	
F	95-00	TAHOE 4x4 Old Body Style	
F	88-00	GMC PICKUP 1 TON, K35 / K3500 Todos	
F	88-00	PICKUP 3/4 TON, K25 / K2500 Todos	
F	90-05	SAFARI AWD	
F	92-99	SUBURBAN 1/2 TON, K15 / K1500 Todos	
F	92-99	SUBURBAN 3/4 TON, K25 / K2500 Todos	
F	92-99	YUKON 4x4	
F	99	YUKON Denali	
81727	D		
R	90-97	FORD AEROSTAR Todos	
R	89	AEROSTAR 4x2 Tracción trasera	

Amortiguadores Guardian

Amort.	POP	No. Alternativo	Montaje Accesorio
Pos.	Año	Aplicación	
81730	A		
R	90	FORD BRONCO II Todos	
R	89	BRONCO II Todos Fab. desde 2/89; Vehículos con perno de 12mm en montaje inferior trasero	
R	90-97	RANGER 4x2 Tracción trasera	
R	89	RANGER 4x2 Tracción trasera Fab. desde 2/89; Vehículos con perno de 12mm en montaje inferior trasero	
R	94-97	MAZDA B2300 4x2 Tracción trasera	
R	94-97	B3000 4x2 Tracción trasera	
81739	X		
R	86-91	DODGE COLT Vista, 4x4	
R	90-91	EAGLE VISTA 4x4	
R	89	VISTA Wagon, 4x4	
R	89-91	PLYMOUTH COLT Vista, 4x4	
81742	D		141665
R	88-93	PONTIAC LEMANS Todos	
81744	A		140780
F	90	FORD BRONCO II Todos	
F	91-94	EXPLORER Todos	
F	90-97	RANGER Todos	
F	92-14	VAN 1/2 TON, ECONOLINE / CLUB WAGON Todos	
F	08-14	VAN 1 TON, ECONOLINE / CLUB WAGON / SUPERDUTY Todos	
F	07	VAN 1 TON, ECONOLINE / CLUB WAGON / SUPERDUTY Todos Exc. Cutaway Chassis	
F	07	VAN 1 TON, ECONOLINE / CLUB WAGON / SUPERDUTY Todos Exc. Paquete de Ambulancia y Manejo	
F	92-06	VAN 1 TON, ECONOLINE / CLUB WAGON / SUPERDUTY Todos	
F	92-14	VAN 3/4 TON, ECONOLINE / CLUB WAGON / SUPERDUTY Todos	
F	94-97	MAZDA B2300 Todos	
F	94-97	B3000 Todos	
F	94-96	B3000 4x2 Tracción trasera	
F	96	B3000 4x4	
F	94	B3000 4x4	
F	94-97	B4000 Todos	
F	91-94	NAVAJO Todos	
81750	A		140455
F	05	CHEVROLET BLAZER Base, 4x2 Tracción trasera	
F	96-04	BLAZER LS, 4x2 Tracción trasera	
F	95-02	BLAZER LT, 4x2 Tracción trasera	
F	95-99	BLAZER Base, 4x2 Tracción trasera	
F	95-97	BLAZER Deluxe, 4x2 Tracción trasera	
F	83-94	BLAZER, S MODELS 4x2 Tracción trasera	
F	68-87	EL CAMINO Todos	
F	94-03	S10 LS, 4x2 Tracción trasera	
F	82-03	S10 Base, 4x2 Tracción trasera	
F	92-93	S10 EL, 4x2 Tracción trasera	
F	83-92	S10 Tahoe, 4x2 Tracción trasera	
F	88-90	S10 Durango, 4x2 Tracción trasera	
F	82-86	S10 Durango, 4x2 Tracción trasera	
F	72-82	FORD COURIER Todos	
F	92-04	GMC JIMMY 4x2 Tracción trasera	
F	83-91	S15 JIMMY 4x2 Tracción trasera	
F	04	SONOMA / S15 Todos 4x2 Tracción trasera	
F	82-03	SONOMA / S15 4x2 Tracción trasera	
F	78-87	SPRINT / CABALLERO 4x2 Tracción trasera	
F	71-77	SPRINT / CABALLERO Todos	
F	96-00	ISUZU HOMBRE 4x2 Tracción trasera Exc. Chasis Deportivo	
F	72-76	MAZDA B1600 Todos	
F	77-78	B1800 Todos	
F	79-84	B2000 Todos	
F	82-84	B2200 Todos	
F	70-83	TOYOTA PICKUP 4x2 Tracción trasera Mojave	
81789	C		
R	99-00	CADILLAC ESCALADE Todos	
R	92-94	CHEVROLET BLAZER 4x4 Automóvil Grande	
R	92-99	SUBURBAN 1/2 TON, C15 / C1500 Todos	
R	92-99	SUBURBAN 1/2 TON, K15 / K1500 Todos	
R	92-99	SUBURBAN 3/4 TON, C25 / C2500 Todos	
R	92-99	SUBURBAN 3/4 TON, K25 / K2500 Todos	
R	95-00	TAHOE Todos Old Body Style	
R	96-11	VAN 1/2 TON, G / EXPRESS Todos	

Lista numérica

Amort.	POP	No. Alternativo	Montaje Accesorio
Pos.	Año	Aplicación	
81789	C	-continued	
R	10-12	VAN 1 TON, G / EXPRESS Todos	
R	97-06	VAN 1 TON, G / EXPRESS Todos	
R	07-09	VAN 3/4 TON, G / EXPRESS Todos	
R	96-02	VAN 3/4 TON, G / EXPRESS Todos Exc. PBV 8600 #	
R	92-99	GMC SUBURBAN 1/2 TON, C15 / C1500 Todos	
R	92-99	SUBURBAN 1/2 TON, K15 / K1500 Todos	
R	92-99	SUBURBAN 3/4 TON, C25 / C2500 Todos	
R	92-99	SUBURBAN 3/4 TON, K25 / K2500 Todos	
R	96-11	VAN 1/2 TON, G / SAVANNA 4x2 Tracción trasera	
R	97-02	VAN 1 TON, G / SAVANNA Todos	
R	96-02	VAN 3/4 TON, G / SAVANNA Todos Exc. PBV 8600 #	
R	92-99	YUKON Todos	
R	99	YUKON Denali, 4x4	
81790	D		142369
R	95-98	BUICK SKYLARK Todos	
R	95-96	CHEVROLET BERETTA Todos	
R	95-96	CORSICA Todos	
R	95-98	OLDSMOBILE ACHIEVA Todos Exc. Suspensión Electrónica Ajustable	
R	95-98	PONTIAC GRAND AM Todos Exc. Suspensión Electrónica Ajustable	
81791	W		141666
R	89-96	CHEVROLET CORVETTE Todos Exc. Suspensión Electrónica Ajustable	
R	88	CORVETTE Todos	
81792	W		141665
F	89-96	CHEVROLET CORVETTE Todos Exc. Suspensión Electrónica Ajustable	
81793	D		
R	88-93	CHRYSLER DYNASTY Todos Sistema Hidráulico de Autonivelación	
R	88-93	DODGE DYNASTY Todos Sistema Hidráulico de Autonivelación	
81794	C		140126
R	03-04	FORD MUSTANG / MUSTANG II Mach I	
R	94-04	MUSTANG / MUSTANG II Base	
R	94-04	MUSTANG / MUSTANG II GT	
R	04	MUSTANG / MUSTANG II GT Base Equipado	
R	01	MUSTANG / MUSTANG II GT Bullitt	
R	95	MUSTANG / MUSTANG II GTS	
81795	D		141743
R	92-96	FORD COUGAR	
R	92-97	THUNDERBIRD Todos Exc. Suspensión Electrónica Ajustable	
R	92-97	MERCURY COUGAR Todos Exc. Suspensión Electrónica Ajustable	
81821	D		
F	87-90	FORD F-200	
F	01	F-250	
F	65-78	F-350 PICKUP	
F	86-97	PICKUP 1 TON, F-350 / SUPERDUTY 4x4	
F	97	PICKUP 3/4 TON, F-250 / SUPERDUTY 4x4 PBV arriba de 8500#	
F	87-96	PICKUP 3/4 TON, F-250 / SUPERDUTY 4x4	
R	72-01	VOLKSWAGEN COMBI	
R	95-01	COMBI Todos	
R	52-77	COMBI CARAVEL	
R	72-01	COMBI PANEL	
81823	C		140719
R	91-94	FORD EXPLORER Todos	
R	91-94	MAZDA NAVAJO Todos	
81825	W		
F	81-93	DODGE PICKUP 1/2 TON, W100 SERIES Todos Exc. Kit de Levantamiento	
F	61-80	PICKUP 1/2 TON, W100 SERIES Todos	

Lista numérica

Amort.	POP	No. Alternativo	Montaje Accesorio
Pos.	Año	Aplicación	
81825	W	-continued	
F	81-93	PICKUP 1 TON, W300 SERIES Todos Exc. Suspensión Quad y Kit de Levantamiento	
F	61-80	PICKUP 1 TON, W300 SERIES Todos	
R	61-71	PICKUP 1 TON, W300 SERIES Todos	
F	90-93	PICKUP 3/4 TON, W200 SERIES Extended Cab Pickup Exc. Kit de Levantamiento	
F	88-93	PICKUP 3/4 TON, W200 SERIES Cab & Chassis Exc. Kit de Levantamiento	
F	81-93	PICKUP 3/4 TON, W200 SERIES Standard Cab Pickup Exc. Kit de Levantamiento	
F	86	PICKUP 3/4 TON, W200 SERIES Cab & Chassis Exc. Kit de Levantamiento	
F	81-83	PICKUP 3/4 TON, W200 SERIES Cab & Chassis Exc. Kit de Levantamiento	
F	81-82	PICKUP 3/4 TON, W200 SERIES Extended Cab Pickup Exc. Kit de Levantamiento	
F	69-80	PICKUP 3/4 TON, W200 SERIES Todos	
F	61-67	PICKUP 3/4 TON, W200 SERIES Todos	
F	74-93	RAMCHARGER 4x4	
F	78-80	RD200 Todos	
F	74-81	PLYMOUTH TRAILDUSTER 4x4	
81826	D	140780	
F	90-97	FORD AEROSTAR AWD	
81828	D	142617	
R	99-02	FORD ECONOLINE WAGON	
R	10-14	VAN 1/2 TON, ECONOLINE / CLUB WAGON Todos	
R	10-14	VAN 1 TON, ECONOLINE / CLUB WAGON / SUPERDUTY Todos	
R	04-14	VAN 1 TON, ECONOLINE / CLUB WAGON / SUPERDUTY Todos Exc. Cutaway Chassis	
R	04-11	VAN 1 TON, ECONOLINE / CLUB WAGON / SUPERDUTY Todos Exc. Paquete de Ambulancia y Manejo	
R	92-05	VAN 1 TON, ECONOLINE / CLUB WAGON / SUPERDUTY Todos	
R	92-14	VAN 3/4 TON, ECONOLINE / CLUB WAGON / SUPERDUTY Todos	
81833	C	140780	
R	92-07	FORD VAN 1/2 TON, ECONOLINE / CLUB WAGON Todos	
81834	C	140126	
F	88-93	DODGE MICROBUS	
F	72-93	PICKUP 1 TON, D300 SERIES Todos Paquete HD	
F	82-93	PICKUP 3/4 TON, D200 SERIES Todos Paquete HD	
F	75-81	PICKUP 3/4 TON, D200 SERIES 165.0 (WheelBase) Paquete HD	
F	72-74	PICKUP 3/4 TON, D200 SERIES Todos Paquete HD	
F	71-93	VAN 1 TON, A / B SERIES / RAM Todos Con Eje Delantero 4000#	
F	74-80	VAN, CB300 Todos Con Eje Delantero 4000#	
F	74-83	PLYMOUTH VAN 1 TON, PB SERIES Todos Con Eje Delantero 4000#	
81836	C	140126	
F	97-04	DODGE DAKOTA 4x4	
F	98-03	DURANGO 4x4	
81837	D		
R	87-96	DODGE DAKOTA 4x4	
81869	B	141353,142592	
F	99-04	JEEP GRAND CHEROKEE Todos	
81870	B	141350	
F	86-95	TOYOTA 4RUNNER Todos	
F	86-95	PICKUP 4x4 Exc. Kit de Levantamiento	
F	93-98	T100 4x4	
81871	B	140149	
R	84-89	TOYOTA 4RUNNER Todos	
R	84-95	PICKUP 4x4 Exc. Kit de Levantamiento	

Amortiguadores Guardian

Amort.	POP	No. Alternativo	Montaje Accesorio
Pos.	Año	Aplicación	
81871	B	-continued 140149	
R	98-04	TACOMA Pre Runner	
R	95-04	TACOMA 4x4	
81872	C	140524	
F	90-92	DAIHATSU ROCKY Todos	
F	94-02	HONDA PASSPORT Todos	
F	98-00	ISUZU AMIGO Todos	
F	02-04	AXIOM Todos	
F	91-04	RODEO Todos	
F	87-90	MITSUBISHI VAN Todos	
F	87-95	NISSAN PATHFINDER Todos	
81873	B		
R	99-06	CHEVROLET PICKUP 1/2 TON, SILVERADO 1500 4x2 Tracción trasera Exc. Suspensión Electrónica Ajustable	
R	07	SILVERADO 1500 CLASSIC 4x2 Tracción trasera Exc. Suspensión Electrónica Ajustable	
R	94-01	DODGE PICKUP 1/2 TON, RAM 1500 Todos	
R	94-02	PICKUP 1 TON, RAM 3500 4x2 Tracción trasera Exc. Eje Delantero Rígido	
R	94-03	PICKUP 3/4 TON, RAM 2500 4x4, GAS Exc. PBV 8600 #	
R	94-02	PICKUP 3/4 TON, RAM 2500 4x2 Tracción trasera	
R	95-96	PICKUP 3/4 TON, RAM 2500 4x4, CNG Exc. PBV 8600 #	
R	99-06	GMC SIERRA 1500 4x2 Tracción trasera Exc. Suspensión Electrónica Ajustable	
R	07	SIERRA 1500 CLASSIC 4x2 Tracción trasera Exc. Suspensión Electrónica Ajustable	
81878	B		
R	96-07	CHRYSLER TOWN & COUNTRY Todos	
R	01-03	VOYAGER / GRAND VOYAGER Todos Exc. Sistema de Autonivelación NIVOMAT	
R	96-00	VOYAGER / GRAND VOYAGER Todos	
R	00	VOYAGER / GRAND VOYAGER Non-ABS	
R	96-07	DODGE CARAVAN / GRAND CARAVAN Todos Exc. Sistema de Autonivelación NIVOMAT	
R	96-00	PLYMOUTH VOYAGER / GRAND VOYAGER Todos	
81880	W		
R	63-82	CHEVROLET CORVETTE Todos	
81882	B		
R	95-03	FORD WINDSTAR Coil (RearSpringType)	
81890	B	140719	
R	95-01	FORD EXPLORER Todos Exc. Suspensión de Aire	
R	98	EXPLORER Todos	
R	01-05	EXPLORER SPORT TRAC Todos	
R	97-01	MERCURY MOUNTAINEER Todos Exc. Suspensión Electrónica Ajustable	
81891	C		
R	93-98	JEEP GRAND CHEROKEE Todos	
81892	B	142700	
R	97-04	FORD LOBO PICK UP	
R	04	PICKUP 1/2 TON, F-150 4x2 Tracción trasera	
R	00-03	PICKUP 1/2 TON, F-150 Harley-Davidson Edition, 4x2 Tracción trasera	
R	99-03	PICKUP 1/2 TON, F-150 Lariat, 4x2 Tracción trasera	
R	99-03	PICKUP 1/2 TON, F-150 XL, 4x2 Tracción trasera	
R	99-03	PICKUP 1/2 TON, F-150 XLT, 4x2 Tracción trasera	
R	00	PICKUP 1/2 TON, F-150 Base, 4x2 Tracción trasera	
R	97-98	PICKUP 1/2 TON, F-150 4x2 Tracción trasera	
R	97-99	PICKUP 3/4 TON, F-250 / SUPERDUTY 4x2 Tracción trasera Hasta PBV 8500#	

Lista numérica

Amort.	POP	No. Alternativo	Montaje Accesorio
Pos.	Año	Aplicación	
81893	A	142277	
F	95-01	FORD EXPLORER Todos Exc. Suspensión Electrónica Ajustable	
F	01-05	EXPLORER SPORT TRAC Todos	
F	12	RANGER Todos 4x4	
F	12	RANGER 4x2 Tracción trasera, Torsion (FrontSpringType)	
F	06-11	RANGER 4x2 Tracción trasera, Barra de Torsion (FrontSpringType)	
F	98-11	RANGER 4x4	
F	01-05	RANGER Edge, 4x2 Tracción trasera	
F	03-06	MAZDA B3000 Todos 4x4	
F	98-02	B3000 4x4	
F	98-06	B4000 4x4	
F	97-01	MERCURY MOUNTAINEER Todos Exc. Suspensión Electrónica Ajustable	
81902	D	140126	
F	87-96	DODGE DAKOTA 4x4	
81904	D	141514	
R	92-93	ASUNA SUNRUNNER Todos	
R	98-04	CHEVROLET TRACKER Non-ABS	
R	89-97	GEO TRACKER Todos	
R	89-91	GMC TRACKER Todos	
R	94-97	PONTIAC SUNRUNNER Todos	
R	99-05	SUZUKI GRAND VITARA Todos	
R	96-98	SIDEKICK Todos	
R	89-95	SIDEKICK Non-ABS	
R	99-04	VITARA Todos	
R	96-98	X-90 Todos	
81905	C		
R	90-97	FORD RANGER 4x4	
R	89	RANGER 4x4 Fab. desde 2/89; Vehículos con perno de 12mm en montaje inferior trasero	
R	95-96	MAZDA B2300 4x4	
R	94-97	B3000 4x4	
R	94-97	B4000 4x4	
81906	D	140921	
R	90-95	TOYOTA 4RUNNER Todos	
81908	C	140673	
F	01-04	TOYOTA TACOMA S-Runner Exc. Offroad Package	
F	04	TACOMA Base, 4x2 Tracción trasera Exc. Offroad Package	
F	95-03	TACOMA DLX, 4x2 Tracción trasera Exc. Offroad Package	
81909	D	140169	
R	96-99	ACURA SLX Todos	
R	92-02	ISUZU TROOPER Todos	
R	99-01	VEHICROSS Todos	
81910	D	141137	
R	98	INFINITI QX4 Todos Fab. hasta 12/98	
R	97	QX4 Todos	
R	96-99	NISSAN PATHFINDER Todos Fab. hasta 12/98	
81911	D	140524	
R	98-02	HONDA PASSPORT Todos	
R	98-00	ISUZU AMIGO Todos	
R	02-04	AXIOM Todos	
R	98-04	RODEO Todos	
81912	A	142731	
F	97-02	FORD EXPEDITION 4x2 Tracción trasera Exc. Nivelación Nuemática Delantera	
F	97-04	LOBO PICK UP	
F	97-04	PICKUP 1/2 TON, F-150 4x2 Tracción trasera	
F	97-99	PICKUP 3/4 TON, F-250 / SUPERDUTY 4x2 Tracción trasera Hasta PBV 8500#	
F	98-02	LINCOLN NAVIGATOR 4x2 Tracción trasera	
81913	C	142700	
R	97-04	FORD LOBO PICK UP	
R	97-04	PICKUP 1/2 TON, F-150 4x4 Exc. PBV 7700#	
R	97-99	PICKUP 3/4 TON, F-250 / SUPERDUTY 4x4 Hasta PBV 8500#, Exc. Superduty	
81914	C	142731	
F	97-02	FORD EXPEDITION 4x4 Exc. Nivelación Nuemática Delantera	
F	97-04	LOBO PICK UP	

Lista numérica

Amort.	POP	No. Alternativo	Montaje Accesorio
Pos.	Año	Aplicación	
81914	C	-continued	142731
F	04	PICKUP 1/2 TON, F-150 4x4 Exc. PBV 7700#	
F	97-03	PICKUP 1/2 TON, F-150 4x4	
F	97-99	PICKUP 3/4 TON, F-250 / SUPERDUTY 4x4 Hasta PBV 8500#, Exc. Superduty	
81916	B		141665
F	12	FORD RANGER Todos Coil (FrontSpringType)	
F	06-11	RANGER 4x2 Tracción trasera, Coil (FrontSpringType)	
F	01-05	RANGER XL, 4x2 Tracción trasera, Coil (FrontSpringType) Exc. Modelos Edge, EV, Splash y Deportivo	
F	01-05	RANGER XLT, 4x2 Tracción trasera, Coil (FrontSpringType) Exc. Modelos Edge, EV, Splash y Deportivo	
F	98-00	RANGER XL, 4x2 Tracción trasera Exc. Modelos Edge, EV, Splash y Deportivo	
F	98-00	RANGER XLT, 4x2 Tracción trasera Exc. Modelos Edge, EV, Splash y Deportivo	
F	01-06	MAZDA B2300 4x2 Tracción trasera	
F	98-01	B2500 4x2 Tracción trasera	
F	98-06	B3000 4x2 Tracción trasera	
F	98-06	B4000 4x2 Tracción trasera	
81917	B		
R	12	FORD RANGER Todos Coil (FrontSpringType)	
R	06-11	RANGER 4x2 Tracción trasera, Coil (FrontSpringType)	
R	98-05	RANGER XL, 4x2 Tracción trasera Exc. Modelos Edge, EV, Splash y Deportivo	
R	98-05	RANGER XLT, 4x2 Tracción trasera Exc. Modelos Edge, EV, Splash y Deportivo	
R	05	RANGER STX, 4x2 Tracción trasera Exc. Modelos Edge, EV, Splash y Deportivo	
R	04	RANGER Tremor, 4x2 Tracción trasera Exc. Modelos Edge, EV, Splash y Deportivo	
R	98-01	MAZDA B2500 Todos	
R	98-06	B3000 4x2 Tracción trasera	
R	98-06	B4000 4x2 Tracción trasera	
81918	C		
R	12	FORD RANGER Todos	
R	12	RANGER 4x2 Tracción trasera, Torsion (FrontSpringType)	
R	06-11	RANGER 4x2 Tracción trasera, Barra de Torsion (FrontSpringType)	
R	98-11	RANGER 4x4	
R	01-05	RANGER Edge, 4x2 Tracción trasera	
R	03-06	MAZDA B3000 Todos 4x4	
R	98-02	B3000 4x4	
R	98-04	B4000 4x4	
81919	D		142731
F	94-01	DODGE PICKUP 1/2 TON, RAM 1500 4x4	
F	99-02	PICKUP 3/4 TON, RAM 2500 4x4 Exc. PBV 8600 #	
F	94-95	PICKUP 3/4 TON, RAM 2500 4x4 Exc. PBV 8600 #	
81920	B		141665
F	99-06	CHEVROLET PICKUP 1/2 TON, SILVERADO 1500 4x2 Tracción trasera Exc. Suspensión Electrónica Ajustable	
F	99-04	PICKUP 3/4 TON, SILVERADO 2500 4x2 Tracción trasera PBV 8600 Lb.; Exc. Suspensión Quadrateer	
F	07	SILVERADO 1500 CLASSIC 4x2 Tracción trasera Exc. Suspensión Electrónica Ajustable	
F	99-06	GMC SIERRA 1500 4x2 Tracción trasera Exc. Suspensión Electrónica Ajustable	
F	07	SIERRA 1500 CLASSIC 4x2 Tracción trasera Exc. Suspensión Electrónica Ajustable	
81921	C		
R	99-06	CHEVROLET PICKUP 1/2 TON, SILVERADO 1500 4x4 Exc. Suspensión Electrónica Ajustable	
R	05-06	PICKUP 1/2 TON, SILVERADO 1500 HD Todos	

Amortiguadores Guardian

Amort.	POP	No. Alternativo	Montaje Accesorio
Pos.	Año	Aplicación	
81921	C	-continued	
R	01-03	PICKUP 1/2 TON, SILVERADO 1500 HD Todos	
R	77-86	PICKUP 1 TON, K30 Todos	
R	90-91	PICKUP 1 TON, R3500 Todos	
R	89	PICKUP 1 TON, R3500 Cab & Chassis, 4x2 Tracción trasera	
R	89	PICKUP 1 TON, R3500 Crew Cab Pickup, 4x2 Tracción trasera	
R	01-09	PICKUP 1 TON, SILVERADO 3500 Todos	
R	07-10	PICKUP 1 TON, SILVERADO 3500 HD Todos	
R	87-88	PICKUP 1 TON, V30 Todos	
R	89-91	PICKUP 1 TON, V3000 / V3500 Todos	
R	99-08	PICKUP 3/4 TON, SILVERADO 2500 Todos	
R	01-10	PICKUP 3/4 TON, SILVERADO 2500 HD Todos	
R	07	SILVERADO 1500 CLASSIC 4x4 Exc. Suspensión Electrónica Ajustable	
R	94-02	DODGE PICKUP 1 TON, RAM 3500 4x4	
R	94-02	PICKUP 1 TON, RAM 3500 4x2 Tracción trasera Eje Delantero Rígido	
R	94-02	PICKUP 3/4 TON, RAM 2500 4x4, DIESEL PBV 8800	
R	77-86	GMC PICKUP 1 TON, K35 / K3500 Todos	
R	87-91	PICKUP 1 TON, V3000 / V3500 Todos	
R	99-06	SIERRA 1500 4x4 Exc. Suspensión Electrónica Ajustable	
R	07	SIERRA 1500 CLASSIC 4x4 Exc. Suspensión Electrónica Ajustable	
R	05-06	SIERRA 1500 HD Todos	
R	01-03	SIERRA 1500 HD Todos	
R	99-04	SIERRA 2500 Todos	
R	01-10	SIERRA 2500 HD Todos	
R	01-06	SIERRA 3500 Todos	
R	07-10	SIERRA 3500 HD Todos	
81922	B		141665
F	02-06	CHEVROLET AVALANCHE 1500 Todos Exc. Control de Manejo Electrónico	
F	99-06	PICKUP 1/2 TON, SILVERADO 1500 4x4 Exc. Suspensión Electrónica Ajustable	
F	07	SILVERADO 1500 CLASSIC 4x4 Exc. Suspensión Electrónica Ajustable	
F	00-06	SONORA Todos Exc. Suspensión Z55	
F	00-06	SUBURBAN 1/2 TON, 1500 Todos Exc. Suspensión Z55 Auto Ride	
F	02-06	TAHOE Todos Exc. Suspensión Z55 Auto Ride	
F	00-01	TAHOE Todos Estilo New Body, Exc. Suspensión Z55	
F	99-06	GMC SIERRA 1500 4x4 Exc. Suspensión Electrónica Ajustable	
F	07	SIERRA 1500 CLASSIC 4x4 Exc. Suspensión Electrónica Ajustable	
F	00-06	YUKON Todos Exc. Suspensión Z55 Auto Ride	
F	00-06	YUKON XL 1/2 TON Todos Exc. Suspensión Z55 Auto Ride	
F	00-06	YUKON XL 3/4 TON Todos Exc. Suspensión Z55 Auto Ride	
81923	C		
R	97-04	DODGE DAKOTA Todos	
R	01-03	DURANGO 4x4	
R	01-03	DURANGO 4x2 Tracción trasera	
R	99-00	DURANGO Todos	
R	98	DURANGO 4x4	
81924	C		
R	02-05	CHEVROLET VENTURE Todos	
R	97-01	VENTURE 4x2 Tracción delantera	
R	02-04	OLDSMOBILE SILHOUETTE AWD	
R	97-04	SILHOUETTE 4x2 Tracción delantera	
R	99-05	PONTIAC MONTANA Todos	
R	97-98	TRANS SPORT Todos	
81925	D		141665
F	02-06	CHEVROLET AVALANCHE 2500 Todos Exc. Control de Manejo Electrónico	
F	05-06	PICKUP 1/2 TON, SILVERADO 1500 HD Todos	

Lista numérica

Amort.	POP	No. Alternativo	Montaje Accesorio
Pos.	Año	Aplicación	
81925	D	-continued	141665
F	01-03	PICKUP 1/2 TON, SILVERADO 1500 HD Todos	
F	01-09	PICKUP 1 TON, SILVERADO 3500 Todos	
F	07-10	PICKUP 1 TON, SILVERADO 3500 HD Todos	
F	05-08	PICKUP 3/4 TON, SILVERADO 2500 Todos	
F	99-04	PICKUP 3/4 TON, SILVERADO 2500 4x4	
F	01-10	PICKUP 3/4 TON, SILVERADO 2500 HD Todos PBV 9200	
F	00-11	SUBURBAN 3/4 TON, 2500 Todos Exc. Suspensión Auto Ride Z55 y Quadrateer	
F	05-06	GMC SIERRA 1500 HD Todos	
F	01-03	SIERRA 1500 HD Todos	
F	99-04	SIERRA 2500 4x4	
F	01-10	SIERRA 2500 HD Todos	
F	01-06	SIERRA 3500 Todos	
F	07-10	SIERRA 3500 HD Barra de Torsion (FrontSpringType)	
F	00-06	YUKON XL 3/4 TON Todos Exc. Sistema de Autonivelación NIVOMAT	
81926	B		
R	99-04	JEEP GRAND CHEROKEE Todos	
81927	D		141727,141354
R	02-05	FORD SABLE	
R	96-01	SABLE Todos Wagon	
R	96-05	TAURUS Wagon	
R	96-05	MERCURY SABLE Wagon	
81928	B		143000
F	94-01	DODGE PICKUP 1/2 TON, RAM 1500 4x2 Tracción trasera	
F	94-02	PICKUP 1 TON, RAM 3500 4x2 Tracción trasera Exc. Eje Delantero Rígido	
F	94-02	PICKUP 3/4 TON, RAM 2500 4x2 Tracción trasera	
81929	D		
R	97-06	JEEP WRANGLER TJ (Código plataforma del fabricante)	
81930	D		
R	07-11	CHEVROLET AVALANCHE 1500 Todos Exc. Suspensión Z55 o ZW7	
R	02-06	AVALANCHE 1500 Todos Exc. Control de Manejo Electrónico	
R	02-06	AVALANCHE 2500 Todos Exc. Control de Manejo Electrónico	
R	00-06	SONORA Todos Exc. Suspensión Z55	
R	07-11	SUBURBAN 1/2 TON, 1500 Todos Exc. Suspensión Z55 o ZW7	
R	00-06	SUBURBAN 1/2 TON, 1500 Todos Exc. Suspensión Z55 Auto Ride	
R	00-11	SUBURBAN 3/4 TON, 2500 Todos Exc. Suspensión Auto Ride Z55 y Quadrateer	
R	07-11	TAHOE Todos Exc. Suspensión Z55 o ZW7	
R	02-06	TAHOE Todos Exc. Suspensión Z55 Auto Ride	
R	00-01	TAHOE Todos Estilo New Body, Exc. Suspensión Z55	
R	07-11	GMC YUKON Todos Exc. Suspensión Z55 o ZW7	
R	00-06	YUKON Todos Exc. Suspensión Z55 Auto Ride	
R	02	YUKON Denali Exc. Suspensión Z55 Auto Ride	
R	00-06	YUKON XL 1/2 TON Todos Exc. Suspensión Z55 Auto Ride	
R	00-06	YUKON XL 3/4 TON Todos Exc. Sistema de Autonivelación NIVOMAT	
81931	D		
R	06-08	DODGE PICKUP 1/2 TON, RAM 1500 Crew Cab Pickup, 4x4	
R	06-08	PICKUP 1/2 TON, RAM 1500 Standard Cab Pickup, 4x4	
R	02-05	PICKUP 1/2 TON, RAM 1500 4x4	
81932	D		
F	02-05	DODGE PICKUP 1/2 TON, RAM 1500 4x4	

Lista numérica

Amort.	POP	No. Alternativo	Montaje Accesorio
Pos.	Año	Aplicación	
81933	C		
F	06-08	DODGE PICKUP 1/2 TON, RAM 1500 Crew Cab Pickup, 4x2 Tracción trasera	
F	06-08	PICKUP 1/2 TON, RAM 1500 Standard Cab Pickup, 4x2 Tracción trasera	
F	02-05	PICKUP 1/2 TON, RAM 1500 4x2 Tracción trasera	
81934	C		142155
R	98-11	VOLKSWAGEN BEETLE Todos	
R	99-11	GOLF	
R	99-11	GTI	
R	13-15	JETTA Sedan A4 Sedan exc. TDI	
R	06-11	JETTA Sedan A4 Sedan exc. TDI	
R	99-05	JETTA A4 (Código plataforma del fabricante), Sedan A4 Sedan exc. TDI	
81935	B		142950
R	08-11	FORD FOCUS Todos	
R	00-07	FOCUS Hatchback	
R	00-07	FOCUS Sedan	
81936	D		
F	97-06	JEEP WRANGLER TJ (Código plataforma del fabricante)	
81937	C		142389
R	94-97	HONDA PASSPORT Todos	
R	91-97	ISUZU RODEO Todos	
R	98-03	TOYOTA SIENNA Todos	
82001	B		141229
R	79	VOLKSWAGEN BEETLE Todos	
R	52-77	BEETLE Todos	
F	52-65	BEETLE Todos	
R	74-83	BRASILIA	
F	66-73	FASTBACK Todos	
R	66-73	FASTBACK Todos	
R	73-80	SAFARI	
R	89-02	SEDAN	
R	52-87	SEDAN	
F	52-72	SEDAN	
R	95-02	SEDAN Todos	
F	66-73	SQUAREBACK Todos	
R	66-73	SQUAREBACK Todos	
R	74-79	SUPER BEETLE Todos	
R	71-73	SUPER BEETLE Todos Montaje inferior con 3 pernos tipo brida	
R	73-74	THING Todos	
F	56-69	TRANSPORTER Todos	
R	56-67	TRANSPORTER Todos	
82002	D		140916
R	74-78	FORD MUSTANG	
R	74-78	MUSTANG / MUSTANG II Todos	
82003	D		
R	69-72	CHEVROLET BLAZER Todos Resorte Trasero	
R	67	C3605	
R	65-67	C20905	
R	67-72	PICKUP 1/2 TON, C10 Todos Resorte Trasero	
R	67-72	PICKUP 3/4 TON, C20 Todos Resorte Trasero	
R	68-72	SUBURBAN 1/2 TON, C10 Todos	
R	68-72	SUBURBAN 3/4 TON, C20 Todos	
R	64-66	VAN 1/2 TON, G / EXPRESS Todos	
R	67-72	VAN 1/2 TON, P SERIES Todos	
R	70-72	GMC JIMMY Todos 4x2 Tracción trasera	
R	67-72	PICKUP 1/2 TON, C15 / C1500 Todos Resorte Trasero	
R	67-72	PICKUP 3/4 TON, C25 / C2500 Todos Resorte Trasero	
R	68-72	SUBURBAN 1/2 TON, C15 / C1500 Todos Resorte Trasero	
R	68-72	SUBURBAN 3/4 TON, C25 / C2500 Todos	
R	64-66	VAN 1/2 TON, G / SAVANNA Todos	
R	68-72	VAN 1/2 TON, P SERIES Todos	
82004	W		140918
R	65-66	CHEVROLET C1405	
R	71-80	FORD PINTO Sedan	
R	75-80	MERCURY BOBCAT Sedan	
82005	B		141147
F	67-79	VOLKSWAGEN BEETLE Todos	
F	66	BEETLE Todos 1300 y 1500	
F	74-83	BRASILIA	
F	73-80	SAFARI	
F	89-02	SEDAN	

Amortiguadores Guardian

Amort.	POP	No. Alternativo	Montaje Accesorio
Pos.	Año	Aplicación	
82005	B	-continued	141147
F	73-87	SEDAN	
F	73-79	SUPER BEETLE Todos	
F	73-74	THING Todos	
82006	D		
R	69-72	CHEVROLET BLAZER Todos Resorte Trasero de Hojas Múltiples	
R	64-72	CS1073	
R	64-72	CS31003	
R	63-72	PICKUP 1/2 TON, C10 Todos Resorte Trasero de Hojas Múltiples	
R	67-72	PICKUP 1 TON, C30 Todos Exc. Eje Trasero 11,000#	
R	67-72	PICKUP 3/4 TON, C20 Todos Resorte Trasero de Hojas Múltiples	
R	63-66	SUBURBAN 1/2 TON, 1500 Todos	
R	67-77	VAN 1/2 TON, G / EXPRESS Todos	
R	63-66	VAN 1/2 TON, P SERIES Todos	
R	76-77	VAN 1 TON, G / EXPRESS Todos	
R	75	VAN 1 TON, G / EXPRESS 110.0 (WheelBase)	
R	75	VAN 1 TON, G / EXPRESS 125.0 (WheelBase)	
R	71-74	VAN 1 TON, G / EXPRESS Todos	
R	68-72	VAN 1 TON, P SERIES Todos Exc. Eje Trasero 11,000#	
R	67-77	VAN 3/4 TON, G / EXPRESS Todos	
R	68-72	VAN 3/4 TON, P SERIES Todos	
R	66	GMC C25/C2500 PICKUP	
R	67-72	PICKUP 1/2 TON, C15 / C1500 Todos Resorte Trasero de Hojas Múltiples	
R	67-72	PICKUP 1 TON, C35/3500 Todos Exc. Eje Trasero 11,000#	
R	67-72	PICKUP 3/4 TON, C25 / C2500 Todos Resorte Trasero de Hojas Múltiples	
R	63-65	PICKUP 1000 SERIES Todos	
R	63-65	PICKUP 1500 SERIES Todos	
R	67-77	VAN 1/2 TON, G / SAVANNA Todos	
R	67	VAN 1/2 TON, P SERIES Todos	
R	76-77	VAN 1 TON, G / SAVANNA Todos	
R	75	VAN 1 TON, G / SAVANNA 110.0 (WheelBase)	
R	75	VAN 1 TON, G / SAVANNA 125.0 (WheelBase)	
R	71-74	VAN 1 TON, G / SAVANNA Todos	
R	68-72	VAN 1 TON, P SERIES Todos Exc. Eje Trasero 11,000#	
R	67-77	VAN 3/4 TON, G / SAVANNA Todos	
R	68-72	VAN 3/4 TON, P SERIES Todos	
R	63-65	VAN, PB 1000 SERIES Todos	
82007	W		140349
F	47-48	FORD DELUXE Todos Amortiguadores de Acción Directa	
R	68	E-100 ECONOLINE	
R	61-67	ECONOLINE Todos	
F	47-48	SUPER DELUXE Todos Amortiguadores de Acción Directa	
F	68	INTERNATIONAL 908C Todos	
F	68	1100C Todos	
F	68	1200C Todos Exc. Travelette c/ base de rueda de 166"	
F	68	1300C Todos Exc. Travelette c/ base de rueda de 166"	
F	68-72	M1100 / M1200 Todos	
F	69	M1400 Todos	
F	61-71	SCOUT Todos	
F	61-66	JEEP CJ3 Todos Exc. 5 Resortes Helicoidales Delanteros y Kit de Levantamiento	
F	72-81	CJ5 Todos Exc. Kit de Levantamiento	
F	61-71	CJ5 Todos Exc. 5 Resortes Helicoidales Delanteros y Kit de Levantamiento	
F	73-81	CJ5D	
F	72-75	CJ6 Todos Exc. Kit de Levantamiento	
F	66-71	CJ6 Todos Exc. 5 Resortes Helicoidales Delanteros y Kit de Levantamiento	
F	76-81	CJ7 Todos Exc. Kit de Levantamiento	
F	66-74	DJ5 Todos Exc. Kit de Levantamiento	
F	66-68	DJ6 Todos	
F	57-65	FC150 Todos	
F	67-73	JEEPSTER Todos	
R	67-69	JEEPSTER Todos	
F	81	SCRAMBLER / CJ8 Todos	
F	61-67	UNIVERSAL Todos	

Lista numérica

Amort.	POP	No. Alternativo	Montaje Accesorio
Pos.	Año	Aplicación	
82007	W	-continued	140349
F	76-83	TOYOTA LAND CRUISER FJ40 (Código plataforma del fabricante)	
F	75	LAND CRUISER FJ40 (Código plataforma del fabricante) Fab. hasta 2/75	
F	67-74	LAND CRUISER Todos	
82010	W		
F	71-78	CADILLAC ELDORADO Todos	
F	67-70	ELDORADO Todos Montado Verticalmente	
F	71-78	OLDSMOBILE TORONADO Todos	
F	66-70	TORONADO Todos Montado Verticalmente	
82011	W		140126
F	65-71	CHRYSLER 300 Todos	
F	67-73	IMPERIAL Todos	
F	65-73	NEWPORT Todos	
F	65-73	NEW YORKER Todos	
F	65-73	TOWN & COUNTRY Todos	
F	65	DODGE 880 Todos	
F	65-73	MONACO Todos	
F	65-73	POLARA Todos	
F	65-73	PLYMOUTH FURY Todos	
F	72-73	GRAN FURY Todos	
F	67	VIP Todos	
82012	W		
F	69-74	FORD VAN 1/2 TON, ECONOLINE / CLUB WAGON Todos	
F	69-74	VAN 1 TON, ECONOLINE / CLUB WAGON / SUPERDUTY Todos	
F	69-74	VAN 3/4 TON, ECONOLINE / CLUB WAGON / SUPERDUTY Todos	
82013	W		141705
R	80-82	TOYOTA TERCEL AL1 (Código plataforma del fabricante)	
82020	X		140673
R	71-73	NISSAN 1200 Todos	
R	74-78	B210 Todos Hatchback	
R	74	TOYOTA COROLLA Wagon Fab. hasta 7/74	
R	71-73	COROLLA Wagon	
82025	W		140873
F	75-80	AMERICAN MOTORS PACER Todos	
82026	W		140455
F	53	CADILLAC DEVILLE Todos	
F	50-53	FLEETWOOD / 60 SERIES / 70 SERIES Todos	
F	50-54	CHEVROLET BEL AIR Todos	
F	53-62	CORVETTE Todos	
F	53-54	ONE-FIFTY SERIES Todos	
F	49-52	STYLELINE DELUXE Todos	
F	49-52	STYLELINE SPECIAL Todos	
F	53-54	TWO-TEN SERIES Todos	
F	50-56	FORD COUNTRY SEDAN Todos	
F	50-56	COUNTRY SQUIRE Todos	
F	54-56	COURIER SEDAN DELIVERY Todos	
F	50-54	CRESTLINE Todos	
F	50-52	CUSTOM Todos	
F	52-56	CUSTOMLINE Todos	
F	49-51	DELUXE Todos	
F	55-56	FAIRLANE Todos	
F	49	FORD Todos	
F	52-56	MAINLINE Todos	
F	56	PARK LANE WAGON Todos	
F	50-56	RANCH WAGON Todos	
F	54-56	SKYLINER Todos	
F	52-56	SUNLINER Todos	
F	55-57	THUNDERBIRD Todos	
F	51-56	VICTORIA Todos	
F	52-56	MERCURY CUSTOM Todos	
F	56	MEDALIST Todos	
F	49-51	MERCURY Todos	
F	55-56	MONTCLAIR Todos	
F	50-56	MONTEREY Todos	
F	55	OLDSMOBILE 98 Todos	
F	57	PONTIAC BONNEVILLE Todos	
F	50-57	CATALINA Todos	
F	49-57	CHIEFTAIN Todos	
F	54-57	STAR CHIEF Todos	
F	49-52	STREAMLINER Todos	
F	57	SUPER CHIEF Todos	
F	56	STUDEBAKER POWER HAWK Todos	
F	55-56	PRESIDENT Todos	
F	56	SKY HAWK Todos	
F	59-68	VOLVO 122 Todos	

Lista numérica

Amort.	POP	No. Alternativo	Montaje Accesorio
Pos.	Año	Aplicación	
82026	W	-continued	140455
F	61-73	1800 Todos	
82030	W		
R	74	INTERNATIONAL 100 Todos	
R	75	150 4x2 Tracción trasera	
F	74-75	200 Todos	
R	74-75	200 Todos	
R	69-70	1000D Todos Antes de Chasis #H-205000	
R	71-72	1010 Todos Antes de Chasis #H-205000	
F	69-70	1100D Todos	
R	69-70	1100D Todos	
F	71-73	1110 Todos	
R	71-73	1110 Todos	
F	69-70	1200D Todos	
R	69-70	1200D Todos	
F	71-73	1210 Todos	
R	71-73	1210 Todos	
F	69-70	1300D Todos	
R	69-70	1300D Todos	
F	71-73	1310 Todos	
R	71-73	1310 Todos	
R	71-80	SCOUT II Todos	
F	75	TRAVELALL Todos	
82031	D		
F	76-78	VOLKSWAGEN HORMIGA	
F	70-79	TRANSPORTER Todos	
82032	D		
R	76-78	VOLKSWAGEN HORMIGA	
R	68-79	TRANSPORTER Todos	
82033	W		140169
F	77-78	FORD F-100	
F	66-74	F-100	
F	75-76	PICKUP 1/2 TON, F-100 4x4 Exc. Kit de Levantamiento	
F	76	PICKUP 1/2 TON, F-150 4x4 Exc. Kit de Levantamiento	
F	75	PICKUP 1/2 TON, F-150 Todos 4x4; Exc. Kit de Levantamiento	
82034	D		141138
R	55-56	CADILLAC DEVILLE Todos	
R	67	ELDORADO Todos Montado Verticalmente	
R	55-56	FLEETWOOD / 60 SERIES / 70 SERIES Todos	
F	75-77	FORD PICKUP 3/4 TON, F-250 / SUPERDUTY 4x4 Toda la serie No. Y20000	
R	67-70	OLDSMOBILE TORONADO Todos Montado Verticalmente	
82035	W		140357
F	60	CHEVROLET PICKUP Todos	
F	61-62	PICKUP 1/2 TON, C10 Todos	
F	61-62	PICKUP 1 TON, C30 Todos	
F	61-62	PICKUP 3/4 TON, C20 Todos	
F	61-62	SUBURBAN 1/2 TON, 1500 Todos	
F	62	VAN 1/2 TON, P SERIES Todos	
F	61-62	GMC PICKUP 1000 SERIES Todos	
F	61-62	PICKUP 1500 SERIES Todos	
F	61-62	PICKUP 2500 SERIES Todos	
82038	W		141138
F	61-64	FORD PICKUP 1/2 TON, F-100 Todos	
F	61-62	PICKUP 3/4 TON, F-250 / SUPERDUTY Todos 4x2 Tracción trasera	
82039	W		140455
R	53-59	CHEVROLET CORVETTE Todos	
R	61-71	INTERNATIONAL SCOUT Todos	
R	69-73	OPEL OPEL Todos	
82040	W		140455
R	68-70	CADILLAC ELDORADO Todos Montado Verticalmente	
R	68-69	CHEVROLET CAMARO Todos Resorte Trasero de Hoja Sencilla	
R	67	CAMARO Todos	
R	66	OLDSMOBILE TORONADO Todos Montado Verticalmente	
R	67	PONTIAC FIREBIRD Todos	
82046	D		
F	61-71	DODGE PICKUP 1/2 TON, D100 SERIES Todos	
F	61-71	PICKUP 1 TON, D300 SERIES Todos	

Amortiguadores Guardian

Amort.	POP	No. Alternativo	Montaje Accesorio
Pos.	Año	Aplicación	
82046	D	-continued	
F	61-71	PICKUP 3/4 TON, D200 SERIES Todos	
R	68	VAN 1/2 TON, P SERIES Todos	
R	62-64	VAN 1/2 TON, P SERIES Todos	
82047	W		140630
F	57-58	CHEVROLET PICKUP Todos	
F	61-67	VAN 1 TON, P SERIES Todos	
F	61-67	VAN 3/4 TON, P SERIES Todos	
F	55-59	GMC PICKUP Todos	
F	67	VAN 1 TON, P SERIES Todos	
F	67	VAN 3/4 TON, P SERIES Todos	
82049	W		140121
F	68	INTERNATIONAL 1000C Todos	
F	69-70	1000D Todos Antes de Chasis #H-205000	
F	71-73	1010 Todos	
82051	D		
R	70	AMERICAN MOTORS GREMLIN Todos	
R	70	HORNET Todos	
R	58-64	CHEVROLET BEL AIR Todos	
R	58-64	BISCAYNE Todos	
R	58	DEL RAY Todos	
R	59-60	EL CAMINO Todos	
R	59-64	IMPALA Todos	
82054	D		
R	60-71	DODGE PICKUP 1/2 TON, D100 SERIES Todos	
R	60-71	PICKUP 1/2 TON, W100 SERIES Todos	
R	60-71	PICKUP 3/4 TON, D200 SERIES Todos	
R	69-71	PICKUP 3/4 TON, W200 SERIES Todos	
R	60-67	PICKUP 3/4 TON, W200 SERIES Todos	
R	59-60	TRUCK Todos	
R	69-72	VAN 3/4 TON, P SERIES Todos	
82060	W		140630
R	65-68	CADILLAC CALAIS Todos	
R	65-68	DEVILLE Todos	
R	65-68	FLEETWOOD Todos	
R	50-51	FLEETWOOD / 60 SERIES / 70 SERIES Todos	
R	57-58	CHEVROLET PICKUP 3200	
R	57-58	PICKUP 3600	
R	50-51	FORD COUNTRY SQUIRE Todos	
R	49	FORD Todos	
R	50-51	RANCH WAGON Todos	
R	55-59	GMC PICKUP Todos Series 100, 150	
R	56	STUDEBAKER POWER HAWK Todos	
R	55-56	PRESIDENT Todos	
R	56	SKY HAWK Todos	
82062	X		
F	70	CHEVROLET VAN 1/2 TON, G / EXPRESS Todos Eje Delantero Rígido	
F	64-69	VAN 1/2 TON, G / EXPRESS Todos	
F	70	VAN 3/4 TON, G / EXPRESS Todos Eje Delantero Rígido	
F	67-69	VAN 3/4 TON, G / EXPRESS Todos	
F	70	GMC VAN 1/2 TON, G / SAVANNA Todos Eje Delantero con Viga en I	
F	64-69	VAN 1/2 TON, G / SAVANNA Todos	
F	70	VAN 3/4 TON, G / SAVANNA Todos Eje Delantero con Viga en I	
F	67-69	VAN 3/4 TON, G / SAVANNA Todos	
82065	W		140478
R	64-70	DODGE A100	
R	74	M300 Todos H3, M3, M-375 H4, M4	
R	74	M350 Todos H3, M3, M-375 H4, M4	
F	60	PICKUP 1/2 TON, W100 SERIES Todos	
R	61-71	PICKUP 1 TON, D300 SERIES Todos	
F	60	PICKUP 3/4 TON, W200 SERIES Todos	
F	53-60	TRUCK Todos	
R	53-58	TRUCK Todos	
R	66-72	VAN 1 TON, P SERIES Todos	
R	61-64	VAN 1 TON, P SERIES Todos	
82066	W		140455
R	60-66	AMERICAN MOTORS AMBASSADOR Todos	
R	61-66	CLASSIC Todos	

Lista numérica

Amort.	POP	No. Alternativo	Montaje Accesorio
Pos.	Año	Aplicación	
82066	W	-continued	140455
R	65-66	MARLIN Todos	
R	53-54	CADILLAC DEVILLE Todos	
R	52-54	FLEETWOOD / 60 SERIES / 70 SERIES Todos	
R	55-57	CHEVROLET BEL AIR Todos	
R	55-57	ONE-FIFTY SERIES Todos	
R	50-53	PICKUP 3100	
R	50-53	PICKUP 3600	
R	50-53	PICKUP 3800	
R	55-57	TWO-TEN SERIES Todos	
R	87-88	ISUZU TROOPER Todos	
82067	W		140126
R	64-69	LINCOLN CONTINENTAL Todos	
82069	D		140435
F	64-68	AMERICAN MOTORS AMERICAN Todos	
F	68-69	AMX Todos	
F	68-69	JAVELIN Todos	
F	69	RAMBLER Todos	
R	62-63	MERCEDES-BENZ 190SL Todos	
82070	W		140494
F	62-67	CHEVROLET CHEVY II Todos	
82072	W		
F	57-64	CHRYSLER 300 Todos	
F	57-66	IMPERIAL Todos	
F	57-64	NEWPORT Todos	
F	57-64	NEW YORKER Todos	
F	57-60	SARATOGA Todos	
F	57-64	TOWN & COUNTRY Todos	
F	57-61	WINDSOR Todos	
F	62-64	DODGE 880 Todos	
F	57-59	CORONET Todos	
F	57-61	CUSTOM Todos	
F	60-61	DART Todos	
F	60-61	POLARA Todos	
F	57-61	PLYMOUTH BELVEDERE Todos	
F	58-61	CUSTOM Todos	
F	60-61	FLEET SPECIAL Todos	
F	57-61	FURY Todos	
F	57-58	PLAZA Todos	
F	57-61	SAVOY Todos	
F	60-61	SPORT WAGON Todos	
F	57-61	SUBURBAN Todos	
82074	W		140455
R	62-67	CHEVROLET CHEVY II Todos	
82075	W		140689
F	62-65	FORD FAIRLANE Todos	
F	62-63	MERCURY METEOR Todos	
82076	W		140524
R	58-59	EDSEL CORSAIR Todos	
R	58-60	RANGER Todos	
R	58-60	VILLAGER Todos	
R	60-64	FORD COUNTRY SEDAN Todos	
R	59-64	COUNTRY SQUIRE Todos	
R	59-60	COURIER SEDAN DELIVERY Todos	
R	64	CUSTOM Todos	
R	60	CUSTOM 300 Todos	
R	60-61	FAIRLANE Todos	
R	63	FORD 300 Todos	
R	60-64	GALAXIE Todos	
R	59	RANCHERO Todos	
R	59-64	RANCH WAGON Todos	
R	59	SKYLINER Todos	
R	60	STARLINER Todos	
R	60	SUNLINER Todos	
R	60	VICTORIA Todos	
R	61-64	MERCURY COLONY PARK Todos	
R	64	COMMUTER Todos	
R	61-62	COMMUTER Todos	
R	63	COUNTRY CRUISER Todos	
R	63-64	MARAUDER Todos	
R	64	MONTCLAIR Todos	
R	61-64	MONTEREY Todos	
R	64	PARKLANE Todos	
R	62-64	VILLAGER Todos	
82079	W		
F	59-64	OLDSMOBILE 88 SERIES Todos	
F	58	88 SERIES Todos Exc. Suspensión de Aire '58	
F	57	88 SERIES Todos	
F	59-64	98 Todos	
F	58	98 Todos Exc. Suspensión de Aire '58	
F	59-63	FIESTA Todos	
F	58	FIESTA Todos Exc. Suspensión de Aire '58	

Lista numérica

Amort.	POP	No. Alternativo	Montaje Accesorio
Pos.	Año	Aplicación	
82079	W	-continued	
F 57	FIESTA	Todos	
F 62-63	JETFIRE	Todos	
F 61-64	STARFIRE	Todos	
F 57	STARFIRE	Todos	
82086	W		
R 60	CHEVROLET PICKUP	Todos	
R 61-62	PICKUP 1/2 TON, C10	Todos	
R 61-62	PICKUP 3/4 TON, C20	Todos	
R 60-62	SUBURBAN 1/2 TON, 1500	Todos	
R 62	VAN 1/2 TON, P SERIES	Todos	
R 61-62	GMC PICKUP 1000 SERIES	Todos	
R 61-62	PICKUP 1500 SERIES	Todos	
82087	W	140455	
F 56	BUICK CENTURY	Todos	
F 61-64	ELECTRA	Todos	
F 61-63	INVICTA	Todos	
F 61-64	LESABRE	Todos	
F 63-65	RIVIERA	Todos	
F 56	ROADMASTER	Todos Exc. Suspensión de Aire	
F 56	SPECIAL	Todos	
F 56	SUPER	Todos Exc. Suspensión de Aire	
F 63-64	WILDCAT	Todos	
F 63-64	STUDEBAKER AVANTI	Todos	
F 57-58	CHAMPION	Todos	
F 57-58	COMMANDER	Todos	
F 57-58	GOLDEN HAWK	Todos	
F 60-62	HAWK	Todos	
F 59-62	LARK	Todos	
F 57-58	PRESIDENT	Todos	
F 57-59	SILVER HAWK	Todos	
82089	W	140629	
R 63-64	OLDSMOBILE 88 SERIES	Todos	
R 63-64	98	Todos	
R 63	FIESTA	Todos	
R 63	JETFIRE	Todos	
R 63-64	STARFIRE	Todos	
82090	D	140126	
F 63-64	DODGE 330	Todos	
F 63-64	440	Todos	
F 70-74	CHALLENGER	Todos	
F 66-72	CHARGER	Todos	
F 65-72	CORONET	Todos	
F 62-76	DART	Todos	
F 61-62	LANCER	Todos	
F 62-64	POLARA	Todos	
F 64-74	PLYMOUTH BARRACUDA	Todos	
F 62-70	BELVEDERE	Todos	
F 70-76	DUSTER	Todos	
F 62-63	FLEET SPECIAL	Todos	
F 62-64	FURY	Todos	
F 67	GTX	Todos	
F 68-72	ROADRUNNER	Todos	
F 65-72	SATELLITE	Todos	
F 62-64	SAVOY	Todos	
F 71-76	SCAMP	Todos	
F 70	SUPERBIRD	Todos	
F 60-76	VALIANT	Todos	
F 74-76	VALIANT DUSTER	Todos	
F 69-76	VALIANT SUPER BEE	Todos	
82093	D		
R 74-75	BUICK APOLLO	Todos	
R 73	APOLLO	Todos Exc. Suspensión HD	
R 75-79	SKYLARK	Todos	
R 68	CHEVROLET CHEVY II Leaf	(RearSpringType) Resorte Trasero de Hoja Sencilla	
R 74-79	NOVA	Todos	
R 73	NOVA	Todos Exc. Suspensión HD	
R 69-72	NOVA Leaf (RearSpringType)	Resorte Trasero de Hoja Sencilla	
R 74-79	OLDSMOBILE OMEGA	Todos	
R 73	OMEGA	Todos Exc. Suspensión HD	
R 77-79	PONTIAC PHOENIX	Todos	
R 73-77	VENTURA	Todos	
R 71-72	VENTURA Leaf (RearSpringType)	Todos	
82099	W	140877	
F 58-60	CADILLAC DEVILLE	Todos	
F 56	DEVILLE	Todos	
F 56-60	FLEETWOOD / 60 SERIES / 70 SERIES	Todos	
F 55-57	CHEVROLET BEL AIR	Todos	
F 60-64	CORVAIR	Todos	
F 61-64	CORVAIR TRUCK	Todos	
F 55-57	ONE-FIFTY SERIES	Todos	
F 55-57	TWO-TEN SERIES	Todos	
F 58	EDSEL BERMUDA	Todos	

Amortiguadores Guardian

Amort.	POP	No. Alternativo	Montaje Accesorio
Pos.	Año	Aplicación	
82099	W	-continued 140877	
F 58	CITATION	Todos	
F 58-59	CORSAIR	Todos	
F 58	PACER	Todos	
F 58-60	RANGER	Todos	
F 58	ROUNDUP	Todos	
F 58-60	VILLAGER	Todos	
F 57-64	FORD COUNTRY SEDAN	Todos	
F 57-64	COUNTRY SQUIRE	Todos	
F 57-60	COURIER SEDAN DELIVERY	Todos	
F 64	CUSTOM	Todos	
F 57	CUSTOM	Todos	
F 58-60	CUSTOM 300	Todos	
F 57-58	DEL RIO WAGON	Todos	
F 57-61	FAIRLANE	Todos	
F 63	FORD 300	Todos	
F 59-64	GALAXIE	Todos	
F 59	RANCHERO	Todos	
F 57-64	RANCH WAGON	Todos	
F 57-59	SKYLINER	Todos	
F 60	STARLINER	Todos	
F 57-60	SUNLINER	Todos	
F 59-60	THUNDERBIRD	Todos	
F 57-60	VICTORIA	Todos	
F 57-64	MERCURY COLONY PARK	Todos	
F 64	COMMUTER	Todos	
F 57-62	COMMUTER	Todos	
F 63	COUNTRY CRUISER	Todos	
F 59-60	COUNTRY CRUISER	Todos	
F 63-64	MARAUDER	Todos	
F 58	MEDALIST	Todos	
F 64	MONTCLAIR	Todos	
F 57-60	MONTCLAIR	Todos	
F 57-64	MONTEREY	Todos	
F 64	PARKLANE	Todos	
F 58-60	PARKLANE	Todos	
F 57	TURNPIKE CRUISER	Todos	
F 62-64	VILLAGER	Todos	
F 57-59	VOYAGER	Todos	
F 58-64	PONTIAC BONNEVILLE	Todos	
F 58-64	CATALINA	Todos	
F 58	CHIEFTAIN	Todos	
F 62-64	GRAND PRIX	Todos	
F 58-64	STAR CHIEF	Todos	
F 58	SUPER CHIEF	Todos	
F 60-61	VENTURA	Todos	
F 67	TOYOTA CROWN	Todos Fabricado antes de Sep/67	
F 65-66	CROWN	Todos	
82103	W	140455	
R 63-64	STUDEBAKER AVANTI	Todos	
82104	D	140496	
F 65-66	FORD MUSTANG / MUSTANG II	Todos	
82109	W	140455	
F 61-64	CADILLAC DEVILLE	Todos	
F 61-64	FLEETWOOD / 60 SERIES / 70 SERIES	Todos	
82110	D	140455	
F 65-70	OLDSMOBILE 88 SERIES	Todos	
F 65-70	98	Todos	
F 67	CUTLASS / CUTLASS SUPREME	Turnpike Cruiser	
F 65-66	STARFIRE	Todos	
F 65-70	PONTIAC BONNEVILLE	Todos	
F 65-70	CATALINA	Todos	
F 67-70	EXECUTIVE	Todos	
F 65-68	GRAND PRIX	Todos	
F 65-66	STAR CHIEF	Todos	
82118	W	141983	
F 58-64	CHEVROLET BEL AIR	Todos	
F 58-64	BISCAYNE	Todos	
F 58	DEL RAY	Todos	
F 59-60	EL CAMINO	Todos	
F 59-64	IMPALA	Todos	
82123	D	141045	
R 57-59	FORD F SERIES	Todos F-100, F-250	
R 68-75	PICKUP P350	Todos	
R 75-76	PICKUP P400	Todos	
R 55-59	GMC PICKUP	Todos Series 250	
R 58-61	JAGUAR XK150	Todos	
R 68-72	OPEL KADETT	Todos	
R 59-65	POLVO 544	Todos	
R 49	PV 444	Todos	
82125	D	140523	
R 78-80	AMERICAN MOTORS AMX	Todos	
R 78-83	CONCORD	Todos	

Lista numérica

Amort.	POP	No. Alternativo	Montaje Accesorio
Pos.	Año	Aplicación	
82125	D	-continued 140523	
R 71-78	GREMLIN	Todos	
R 71-77	HORNET	Todos	
R 79-83	SPIRIT	Todos	
R 75-76	CADILLAC COMMERCIAL	CHASSIS Todos	
R 58-64	DEVILLE	Todos	
R 57-64	FLEETWOOD / 60 SERIES / 70 SERIES	Todos	
R 72-82	FORD COURIER	Todos	
R 72-76	MAZDA B1600	Todos	
R 77-78	B1800	Todos	
R 79-84	B2000	Todos	
R 82-84	B2200	Todos	
R 76-78	NISSAN F10 Wagon	Todos	
R 59-66	PEUGEOT 403	Todos	
R 61-67	404	Todos	
82126	D	141164	
F 70-74	AMERICAN MOTORS	AMBASSADOR Todos	
F 70-74	AMX	Todos	
F 78-80	AMX	Todos	
F 78-83	CONCORD	Todos	
F 70-78	GREMLIN	Todos	
F 70-77	HORNET	Todos	
F 70-74	JAVELIN	Todos	
F 71-78	MATADOR	Todos	
F 79-83	SPIRIT	Todos	
F 66-70	FORD FAIRLANE	Todos	
F 60-70	FALCON	Todos	
F 60-71	RANCHERO	Todos	
F 65-74	RANCH WAGON	Todos	
F 68-71	TORINO	Todos	
F 60-69	MERCURY COMET	Todos	
F 68-71	MONTEGO	Todos	
82128	D		
F 74-78	FORD MUSTANG	Todos	
F 74-77	MUSTANG / MUSTANG II	Todos	
F 71-80	PINTO	Sedan	
F 75-80	MERCURY BOBCAT	Todos	
82129	W	140455	
F 75-80	BUICK SKYHAWK	Todos	
F 75-80	CHEVROLET MONZA	Todos	
F 71-77	VEGA	Todos	
F 75-80	OLDSMOBILE STARFIRE	Todos	
F 75-77	PONTIAC ASTRE	Todos	
F 63	LEMANS	Todos	
F 76-80	SUNBIRD	Todos	
F 61-63	TEMPEST	Todos	
82130	D	141132	
R 75-80	FORD GRANADA	Todos	
R 70-77	MAVERICK	Todos	
R 77-80	LINCOLN VERSAILLES	Todos	
R 71-77	MERCURY COMET	Todos	
R 75-80	MONARCH	Todos	
R 66-70	NISSAN 1600	Todos	
R 68-70	2000	Todos	
82131	D		
R 65-69	CHRYSLER 300	Todos	
R 75-76	CORDOBA	Todos	
R 74-75	IMPERIAL	Todos	
R 74-78	NEWPORT	Todos	
R 65-69	NEWPORT	Todos	
R 74-78	NEW YORKER	Todos	
R 65-69	NEW YORKER	Todos	
R 74-78	TOWN & COUNTRY	Todos	
R 65-70	TOWN & COUNTRY	Todos	
R 63-64	DODGE 330	Todos	
R 63-64	440	Todos	
R 65	880	Todos	
R 70-74	CHALLENGER	Todos	
R 66-76	CHARGER	Todos	
R 65-76	CORONET	Todos	
R 62	DART	Todos	
R 72-78	MONACO	Todos	
R 65-70	MONACO	Todos	
R 73	POLARA	Todos Exc. Wagon	
R 72	POLARA	Todos	
R 62-70	POLARA	Todos	
R 75-77	ROYAL MONACO	Todos	
R 70-74	PLYMOUTH BARRACUDA	Todos	
R 62-70	BELVEDERE	Todos	
R 62-63	FLEET SPECIAL	Todos	
R 77-78	FURY	Todos Paquete Policía	
R 73-76	FURY	Todos	
R 73	FURY Wagon	Todos	
R 62-69	FURY	Todos	
R 74-77	GRAN FURY	Todos	
R 73	GRAN FURY Wagon	Wagon	
R 67	GTX	Todos	
R 68-75	ROADRUNNER	Todos	

Lista numérica

Amort.	POP	No. Alternativo	Montaje Accesorio
Pos.	Año	Aplicación	
82131	D	-continued	
R	65-74	SATELLITE Todos	
R	62-64	SAVOY Todos	
R	70	SUPERBIRD Todos	
R	67	VIP Todos	
82138	W	140455	
F	65-67	BUICK GRAN SPORT Todos	
F	64-67	SKYLARK Todos Suspensión HD Exc. Sportwagon	
F	64-67	SPECIAL Todos Suspensión HD Exc. Sportwagon	
F	64-67	SPORTWAGON Todos	
F	64-67	CHEVROLET CHEVELLE Todos	
F	64-67	EL CAMINO Todos	
F	64-67	MALIBU Todos	
F	64-67	OLDSMOBILE CUTLASS / CUTLASS SUPREME Base	
F	64-67	CUTLASS / CUTLASS SUPREME Holiday	
F	64-67	F85 Todos	
F	64-67	PONTIAC GTO Todos	
F	64-67	LEMANS Todos	
F	64-67	TEMPEST Todos	
82139	W		
R	63-80	TRIUMPH SPITFIRE Todos	
82147	W		
R	75-77	FORD PICKUP 3/4 TON, F-250 / SUPERDUTY 4x4 Toda la serie No. Y20000	
82151	W		
R	57-58	STUDEBAKER CHAMPION Todos	
R	57-58	COMMANDER Todos	
R	57-58	GOLDEN HAWK Todos	
R	60-62	HAWK Todos	
R	59-62	LARK Todos	
R	57-58	PRESIDENT Todos	
R	57-59	SILVER HAWK Todos	
82155	W	141041	
R	67-69	AMERICAN MOTORS AMBASSADOR Todos	
R	64-68	AMERICAN Todos	
R	59-62	AMERICAN Todos	
R	68-69	AMX Todos	
R	68-69	JAVELIN Todos	
R	67	MARLIN Todos	
R	69	RAMBLER Todos	
R	59-60	RAMBLER Todos	
R	59-60	BUICK ELECTRA Todos Exc. Suspensión de Aire	
R	59-60	INVICTA Todos Exc. Suspensión de Aire	
R	59-60	LESABRE Todos Exc. Suspensión de Aire	
R	50-54	CHEVROLET BEL AIR Todos	
R	60-62	CORVETTE Todos	
R	53-54	ONE-FIFTY SERIES Todos	
R	55-58	PICKUP 3800	
R	54	PICKUP Todos	
R	49-52	STYLELINE DELUXE Todos	
R	49-52	STYLELINE SPECIAL Todos	
R	53-54	TWO-TEN SERIES Todos	
R	61-62	VAN 1 TON, P SERIES Todos	
R	61-62	VAN 3/4 TON, P SERIES Todos	
R	66-67	FIAT 1100 Todos Exc. Wagon	
R	64-67	1500 Todos Exc. Wagon	
R	53-54	GMC PICKUP Todos 1/2 y 3/4 Ton	
R	64-65	NISSAN 410 Todos	
R	64-67	411 Todos	
R	65-71	STATION WAGON	
R	68-73	TOYOTA CORONA Base, Hardtop	
R	68-73	CORONA Base, Sedan	
82156	D		
R	57-58	BUICK CENTURY Todos	
R	58	LIMITED Todos	
R	57-58	ROADMASTER Todos Exc. Suspensión de Aire	
R	57-58	SPECIAL Todos Exc. Suspensión de Aire	
R	57-58	SUPER Todos Exc. Suspensión de Aire	
R	75-80	DODGE COLT Wagon	
R	71-74	COLT Todos	
R	75-76	FIAT 124 Todos Wagon	
R	67-74	124 Wagon Wagon	
R	66-67	1100 Todos Wagon	
R	64-67	1500 Todos Wagon	
R	50-51	FORD COUNTRY SEDAN Todos	
R	50-51	CRESTLINE Todos	
R	50-51	CUSTOM Todos	
R	49-51	DELUXE Todos	

Amortiguadores Guardian, Bases de Struts

Amort.	POP	No. Alternativo	Montaje Accesorio
Pos.	Año	Aplicación	
82156	D	-continued	
R	47-48	DELUXE Todos Amortiguadores de Acción Directa	
R	47-48	SUPER DELUXE Todos Amortiguadores de Acción Directa	
R	51	VICTORIA Todos	
R	78-81	NISSAN 510 Wagon	
R	83-84	MAXIMA Wagon	
R	92-05	TSUBAME	
R	51-56	OLDSMOBILE 98 Todos	
R	76-80	PLYMOUTH COLT Todos	
R	57-60	PONTIAC BONNEVILLE Todos	
R	58-60	CATALINA Todos Wagon, Exc. Suspensión de Aire	
R	50-57	CATALINA Todos	
R	58	CHIEFTAIN Todos Wagon, Exc. Suspensión de Aire	
R	49-57	CHIEFTAIN Todos	
R	54-60	STAR CHIEF Todos	
R	49-52	STREAMLINER Todos	
R	57-58	SUPER CHIEF Todos	
R	60	VENTURA Todos	
R	75-78	TOYOTA CORONA Wagon	
R	74	CORONA Wagon Wagon	
R	73	CORONA Wagon Fabricado desde 8/73	
R	69-71	CORONA Mark II, Wagon	
R	65-66	CROWN Wagon	
82601	W	140455	
F	65-70	BUICK ELECTRA Todos	
F	70	ESTATE WAGON Todos	
F	65-70	LESABRE Todos	
F	66-70	RIVIERA Todos	
F	65-70	WILDCAT Todos	
F	65-76	CADILLAC CALAIS Todos	
F	75-76	COMMERCIAL CHASSIS Todos	
F	65-76	DEVILLE Todos	
F	65-76	FLEETWOOD Todos	
82602	W	140629	
R	65-70	BUICK ELECTRA Todos	
R	65-70	LESABRE Todos	
R	65-70	WILDCAT Todos	
R	71-76	CADILLAC CALAIS Todos	
R	71-76	DEVILLE Todos	
R	71-76	FLEETWOOD Todos	
82603	W	140633	
R	73-76	FORD THUNDERBIRD Todos	
R	73-76	LINCOLN MARK IV Todos	
R	77-79	MARK V Todos	
82607	D		
F	56-57	SAAB 93 Todos	
F	58-59	93B Todos	
F	59-73	95 Todos	
F	61-73	96 Todos	
F	69-80	99 Todos	
F	58-62	GT750 Todos	
F	63	GT850 Todos	
82609	W		
R	61-64	BUICK ELECTRA Todos	
R	61-63	INVICTA Todos	
R	61-64	LESABRE Todos	
R	63-65	RIVIERA Todos	
R	63-64	WILDCAT Todos	
82610	W	140645	
R	69-70	CADILLAC CALAIS Todos	
R	69-70	DEVILLE Todos	
R	69-70	FLEETWOOD Todos	
82614	X		
F	76-79	FIAT 124 Todos Fabricados después de la Serie #066.059	
F	67-75	124 Todos	
F	71-75	OPEL 1900 Todos	
F	71-75	MANTA Todos	
82615	W		
F	61-69	LINCOLN CONTINENTAL Todos	
82617	W	140126	
R	64-66	FORD THUNDERBIRD Todos	
82618	W	140629	
R	66-70	BUICK RIVIERA Todos	
Bases de Struts			
141974	X		
R	93	ASUNA GT, SE+C487 Todos	
R	93	SE Todos	
R	82-96	BUICK CENTURY Todos	
R	82-89	SKYHAWK Todos	

Lista numérica

Amort.	POP	No. Alternativo	Montaje Accesorio
Pos.	Año	Aplicación	
141974	X	-continued	
R	84-98	SKYLARK Todos	
R	85-87	SOMERSET / SOMERSET REGAL Todos	
R	84-88	CADILLAC CIMARRON Todos	
R	95-96	CHEVROLET BERETTA Todos	
R	92-94	BERETTA Base Exc. Suspensión FE7	
R	87-91	BERETTA Todos	
R	87-94	CAVALIER Todos	
R	84-86	CAVALIER Todos Struts Reconstruibles de EO	
R	82-83	CAVALIER Todos	
R	82-90	CELEBRITY Todos	
R	84-85	CITATION / CITATION II Todos	
R	87-96	CORSICA Todos	
R	90-96	LUMINA APV Todos	
R	92-98	OLDSMOBILE ACHIEVA Todos Exc. Suspensión Electrónica Ajustable	
R	85-87	CALAIS Todos	
R	85-96	CIERA / CUTLASS CIERA Todos Exc. Suspensión Electrónica Ajustable	
R	84	CIERA / CUTLASS CIERA Todos	
R	88-91	CUTLASS CALAIS Todos	
R	87-94	CUTLASS CLASSIC / CUTLASS CRUISER Todos Exc. Suspensión Electrónica Ajustable	
R	84-88	FIRENZA Todos	
R	90-96	SILHOUETTE Todos	
R	89-91	PONTIAC 6000 4x2 Tracción delantera	
R	84-88	6000 Todos	
R	95-98	GRAND AM Todos Exc. Suspensión Electrónica Ajustable	
R	85-94	GRAND AM Todos	
R	84-85	J2000 / SUNBIRD Todos	
R	84	PHOENIX Todos	
R	94	SUNBIRD Todos	
R	91-93	SUNBIRD Todos Suspensión Deportiva	
R	86-90	SUNBIRD Todos	
R	87-91	TEMPEST Todos	
R	90-96	TRANS SPORT Todos	
142132	X		
R	85-90	BUICK ELECTRA Todos	
R	86-99	LESABRE Todos	
R	91-96	PARK AVENUE Todos	
R	93	CADILLAC 60 SPECIAL Todos	
R	92-93	COMMERCIAL CHASSIS 4x2 Tracción delantera Suspensión Trasera Asistida por Aire; Exc. Suspensión Electrónica Ajustable	
R	91	COMMERCIAL CHASSIS Todos Suspensión Trasera Asistida por Aire; Exc. Suspensión Electrónica Ajustable	
R	85-90	COMMERCIAL CHASSIS Todos Equipamiento Estándar para Suspensión Trasera Asistida por Aire	
R	85-93	DEVILLE Todos	
R	91-93	FLEETWOOD Todos Exc. Suspensión Electrónica Ajustable	
R	87-90	FLEETWOOD Todos Equipamiento Estándar para Suspensión Trasera Asistida por Aire	
R	85-86	FLEETWOOD Todos Exc. Suspensión Electrónica Ajustable	
R	92-99	OLDSMOBILE 88 SERIES Todos	
R	86-91	88 SERIES Todos Sistema de Autonivelación NIVOMAT de EO opcional	
R	85-96	98 Todos	
R	96-99	LSS Todos	
R	97-98	REGENCY Todos	
R	87-99	PONTIAC BONNEVILLE Todos	
142135	X		
R	91-98	BMW 318i Todos	
R	84-85	318i Todos	
R	91-98	318IS Todos	
R	95-99	318TI Todos	
R	98-99	323i Todos	
R	87-88	325 Todos	
R	84-87	325E Todos	
R	92-95	325i E36 (Código plataforma del fabricante)	
R	87-91	325i Todos	
R	87-92	325IS Todos	
R	88-91	325IX Todos	
R	96-98	328i Todos	
R	88-91	M3 Todos	

Lista numérica

Amort.	POP	No. Alternativo	Montaje Accesorio
Pos.	Año	Aplicación	
142143 W			
F	88-96	BUICK	REGAL Todos
F	90-01	CHEVROLET	LUMINA Todos
F	95-99	MONTE CARLO	Todos Exc. Suspensión HD
F	88-97	OLDSMOBILE	CUTLASS / CUTLASS SUPREME Todos
F	90-96	PONTIAC	GRAND PRIX Todos
142173 X			
R	83-87	DODGE	CHARGER Todos
R	78-90	OMNI	Todos
R	87-89	PLYMOUTH	EXPO Todos
R	78-90	HORIZON	Todos
R	85	TURISMO	Todos
R	83	TURISMO	Todos
142183 X			
F	86-89	MAZDA	323 Todos Exc. Suspensión Electrónica Ajustable
F	81-85	GLC	Hatchback
F	81-85	GLC	Sedan
F	87-89	MERCURY	TRACER 4x2 Tracción delantera
142190 X			
R	91-03	FORD	ESCORT Todos
R	90-94	MAZDA	323 Todos
R	90-94	PROTÉGÉ / PROTÉGÉ5	4x2 Tracción delantera. Non-ABS
R	91-99	MERCURY	TRACER 4x2 Tracción delantera
142195 X			
F	88-92	AUDI	80 Todos
F	88-92	80 QUATTRO	Todos
F	93-95	90	Todos
F	88-91	90	Todos
F	93-95	90 QUATTRO	Todos
F	88-91	90 QUATTRO	Todos
F	80-87	4000	Todos
F	84-87	4000 QUATTRO	Todos
F	83-87	COUPE	Todos
F	90-91	COUPE QUATTRO	Todos
F	82-88	VOLKSWAGEN	QUANTUM Todos
142196 X			
R	89-92	FORD	PROBE Todos
R	88-92	MAZDA	626 Todos Exc. Suspensión Electrónica Ajustable o con dirección en las 4 ruedas
R	88-92	MX6	Todos Exc. Suspensión Electrónica Ajustable o con dirección en las 4 ruedas
142197 X			
F	78-83	FORD	FAIRMONT Todos
F	81-82	GRANADA	Todos
F	83-86	LTD / COUNTRY SEDAN / COUNTRY SQUIRE / CROWN VICTORIA	Todos
F	82-04	MUSTANG / MUSTANG II	Todos
F	79-86	MERCURY	CAPRI Todos
F	81-82	COUGAR	Base
F	82	COUGAR	GS
F	82	COUGAR	LS
F	83-86	MARQUIS	Todos
F	78-83	ZEPHYR	Todos
142219 X			
F	89-90	DODGE	2000 GTX Todos Exc. Sistema de Autonivelación
F	90-94	EAGLE	TALON Todos
F	90-94	MITSUBISHI	ECLIPSE Todos
F	90-94	PLYMOUTH	LASER Todos
142222 W			
F	89-97	FORD	THUNDERBIRD Todos Exc. Suspensión Electrónica Ajustable
F	89-97	MERCURY	COUGAR Todos Exc. Suspensión Electrónica Ajustable
142223 X			
F	82-96	BUICK	CENTURY Todos
F	80-85	SKYLARK	Todos
F	82-90	CHEVROLET	CELEBRITY Todos
F	80-85	CITATION / CITATION II	Todos
F	90-96	LUMINA	APV Todos
F	85-96	OLDSMOBILE	CIERA / CUTLASS CIERA Todos Exc. Suspensión Electrónica Ajustable
F	82-84	CIERA / CUTLASS	CIERA Todos
F	87-94	CUTLASS CLASSIC / CUTLASS CRUISER	Todos Exc. Suspensión Electrónica Ajustable
F	90-96	SILHOUETTE	Todos

Bases de Struts

Amort.	POP	No. Alternativo	Montaje Accesorio
Pos.	Año	Aplicación	
142223 X -continued			
F	91	PONTIAC	6000 4x2 Tracción delantera
F	82-90	6000	Todos
F	80-84	PHOENIX	Todos
F	90-96	TRANS SPORT	Todos
142226 X			
F	90-96	BUICK	LESABRE Todos
F	91-96	PARK AVENUE	Todos
F	93	CADILLAC	60 SPECIAL Todos
F	91-92	BROUGHAM	Todos
F	92-93	COMMERCIAL CHASSIS	4x2 Tracción delantera
F	91	COMMERCIAL CHASSIS	Todos
F	91-93	DEVILLE	Todos Exc. Suspensión Electrónica Ajustable
F	91-93	FLEETWOOD	Todos
F	90-96	OLDSMOBILE	88 SERIES Todos
F	91-96	98	Todos
F	98-99	PONTIAC	BONNEVILLE Air (RearSpringType) Manejo con Comando Computarizado (CCR)
F	94-96	BONNEVILLE	Todos Manejo con Comando Computarizado (CCR)
F	91-93	BONNEVILLE	Todos
F	90	BONNEVILLE	Todos Strut Delantero de Segundo Diseño sin Resorte de Seguridad
142227 X			
F	85-90	BUICK	ELECTRA Todos
F	86-90	LESABRE	Todos
F	91-96	PARK AVENUE	Todos
F	95-98	SKYLARK	Todos
F	92-94	SKYLARK	Todos Exc. FE3 y Control de Manejo Electrónico
F	93	CADILLAC	60 SPECIAL Todos
F	87-93	ALLANTE	Todos
F	92-93	COMMERCIAL CHASSIS	4x2 Tracción delantera
F	85-91	COMMERCIAL CHASSIS	Todos
F	85-93	DEVILLE	Todos
F	91-02	ELDORADO	Todos
F	85-93	FLEETWOOD	Todos
F	87-97	SEVILLE	Todos
F	92-96	CHEVROLET	BERETTA Todos
F	95-98	CAVALIER	Todos
F	92-96	CORSICA	Todos
F	86-96	OLDSMOBILE	88 SERIES Todos
F	91-96	98	Todos Exc. Suspensión Soft Ride (FE1) y Elect. Ride y Handling (FW1)
F	85-90	98	Todos
F	95-98	ACHIEVA	Todos Exc. Suspensión Electrónica Ajustable
F	92-94	ACHIEVA	Todos Suspensión FE3
F	95-96	AURORA	Todos
F	90-92	TORONADO	Todos
F	87-96	PONTIAC	BONNEVILLE Todos
F	95-98	GRAND AM	Todos Exc. Suspensión Electrónica Ajustable
F	92-94	GRAND AM SE	Exc. FE3 y Control de Manejo Electrónico
F	95-98	SUNFIRE	Todos
142229 X			
R	98-02	CHEVROLET	PRIZM Todos Derecho
R	89-97	GEO	PRIZM Todos Derecho
R	88-02	TOYOTA	COROLLA 4x2 Tracción delantera Derecho
142230 C			
F	01-03	ACURA	CL Todos
F	97-99	CL	Todos
R	97-03	EL	Todos
F	97-00	EL	Todos
F	90-01	INTEGRA	Todos
R	90-93	INTEGRA	Todos
F	89-90	LEGEND	Todos Exc. Sistema de Autonivelación
F	86-88	LEGEND	Todos
R	02-06	RSX	Todos
R	99-14	TL	Todos
F	95-14	TL	Todos
F	92-94	VIGOR	Todos
F	08-12	HONDA	ACCORD Todos
R	98-12	ACCORD	Todos
F	03-07	ACCORD	2.4L 4Cyl L (2354)
F	86-02	ACCORD	Todos
R	89-05	CIVIC	Todos
F	89-00	CIVIC	Todos
F	88	CIVIC	Hatchback
F	88	CIVIC	Hatchback
R	88	CIVIC	Sedan
R	88	CIVIC	Sedan

Lista numérica

Amort.	POP	No. Alternativo	Montaje Accesorio
Pos.	Año	Aplicación	
142230 C -continued			
F	93-97	CIVIC	DEL SOL Todos
R	93-97	CIVIC	DEL SOL Todos
R	03-12	CR-V	Todos
F	97-01	CR-V	Todos
R	97-01	CR-V	Todos
F	88-91	CRX	Todos
R	88-91	CRX	Todos
R	03-11	ELEMENT	Todos
F	95-98	ODYSSEY	Todos
R	95-98	ODYSSEY	Todos
F	83-01	PRELUDE	Todos
R	06-12	RIDGELINE	Todos
R	00-09	S2000	Todos
F	00-07	S2000	Todos
F	96-99	SUZUKI	OASIS Todos
R	96-99	OASIS	Todos
142231 X			
R	01-03	ACURA	CL Todos
R	97-99	CL	Todos
R	86-89	INTEGRA	Todos
R	89-90	LEGEND	Todos Exc. Sistema de Autonivelación
R	87-88	LEGEND	Coupe
R	92-94	VIGOR	Todos
R	79-97	HONDA	ACCORD Todos
R	80-87	CIVIC	Todos
R	92-01	PRELUDE	Todos
R	79-87	PRELUDE	Todos
142237 W			
F	90-97	MAZDA	MIATA Non-ABS
R	90-97	MIATA	Non-ABS
142241 X			
F	70-73	NISSAN	240Z Todos
F	74	260Z	Todos Fab. 9/74
F	75-78	280Z	Todos
F	79-83	280ZX	Todos
F	84-89	300ZX	Todos
F	73-76	610	Todos
F	77-81	810	Todos
F	90-94	AXXESS	Todos
F	89-94	MAXIMA	Todos Exc. Suspensión Electrónica Ajustable
F	82-84	MAXIMA	Todos
F	83-85	PULSAR / PULSAR NX	Todos
F	93-02	QUEST	Todos
142242 X			
F	86-88	NISSAN	MAXIMA Sedan Exc. Suspensión Electrónica Ajustable
F	85	MAXIMA	Todos Exc. Suspensión Electrónica Ajustable
F	87-88	MULTI	Todos
F	87-89	STANZA	Sedan
F	81-82	TOYOTA	CRESSIDA Todos Exc. Suspensión Electrónica Ajustable
F	78-80	CRESSIDA	Todos
142244 X			
F	91-02	SATURN	SC / SL / SW SERIES Todos
142245 X			
R	91-02	SATURN	SC / SL / SW SERIES Todos
142247 X			
F	83-88	TOYOTA	TERCEL Wagon
142249 X			
R	85-88	CHEVROLET	NOVA Todos
R	88-89	TOYOTA	CELICA GT
R	88-89	CELICA	GTS
R	88-89	CELICA	ST
R	86-87	CELICA	Todos
R	84-87	COROLLA	Todos
R	87	TERCEL	Wagon
R	83-86	TERCEL	Todos
142293 W			
F	98-01	CHEVROLET	METRO Non-ABS
F	89-91	SPRINT	Todos
F	89-97	GEO	METRO Non-ABS
F	94	PONTIAC	FIREFLY Todos
F	89-91	FIREFLY	Todos
F	89-01	SUZUKI	SWIFT Todos
142294 W			
F	92-93	ASUNA	SUNRUNNER Todos
F	98-03	CHEVROLET	TRACKER Non-ABS
F	89-97	GEO	TRACKER Todos
F	94-97	PONTIAC	SUNRUNNER Todos
F	89-98	SUZUKI	SIDEKICK Non-ABS

Lista numérica

Amort.	POP	No. Alternativo	Montaje Accesorio
Pos.	Año	Aplicación	
142295 X			
R	98-01	CHEVROLET	METRO Non-ABS
R	89-91	SPRINT	Todos
R	89-97	GEO	METRO Non-ABS
R	94	PONTIAC	FIREFLY Todos
R	89-91	FIREFLY	Todos
R	89-01	SUZUKI	SWIFT Todos
142297 W			
F	90-91	BUICK	REATAA Todos
F	90-93	RIVIERA	Todos
F	87-92	CADILLAC	ALLANTE Todos Exc. Suspensión Electrónica Ajustable
F	87-02	ELDORADO	Todos
F	87-92	SEVILLE	Todos
F	90-92	OLDSMOBILE	TORONADO Todos
142298 X			
F	88-89	BUICK	REATAA Todos
F	86-89	RIVIERA	Todos
F	86	CADILLAC	ELDORADO Todos
F	86	SEVILLE	Todos
F	86-89	OLDSMOBILE	TORONADO Todos
142300 X			
R	90-93	ACURA	INTEGRA Todos
R	98-02	HONDA	ACCORD Todos
R	89-95	CIVIC	Todos
R	93-97	CIVIC DEL SOL	Todos
142302 X			
R	91-93	NISSAN	NX Todos
R	93-94	SENTRA	Todos
R	91-92	SENTRA	Non-ABS
142307 D			
F	92-99	TOYOTA	PASEO Todos
F	91-99	TERCEL	Todos
142316 X			
F	88-94	CHEVROLET	BLAZER, S MODELS 4x4, Barra de Torsion (FrontSpringType)
F	88-04	S10 4x4	Barra de Torsion (FrontSpringType)
F	05	GMC	JIMMY 4x4
F	92-04	JIMMY	Todos
F	83-91	S15 JIMMY	Todos
F	88-94	SONOMA / S15 4x4	Barra de Torsion (FrontSpringType)
F	91	SYCLONE	Barra de Torsion (FrontSpringType)
F	92-93	TYPHOON	Todos
F	91-94	OLDSMOBILE	BRAVADA Barra de Torsion (FrontSpringType)
142317 X			
F	93	ASUNA	SUNFIRE Todos
F	90-93	GEO	STORM Non-ABS
F	90-92	ISUZU	IMPULSE Todos Exc. Suspensión Lotus
F	91-93	STYLUS	Todos Exc. Suspensión Lotus
142326 W			
F	84-89	MERCEDES-BENZ	190D Todos
F	84-93	190E	Todos
F	87-89	260E	Todos Exc. 4 Matic 4x4
F	90-93	300D	Todos Exc. 4 Matic 4x4
F	86-93	300E	Todos Exc. 4 Matic 4x4
F	92-93	400E / 400SE / 400SEL / 420SEL / 450SE / 450SEL	Todos
F	90-93	500SL	Todos
F	93	600SL	Todos
F	95	E300	Todos
F	94-95	E320	Todos
F	94-95	E420	Todos
F	94	E500	Todos
F	94-02	SL320 / SL500 / SL600	Todos
142329 X			
F	93-95	DODGE	COLT Todos
F	93-96	EAGLE	SUMMIT Coupe
F	93-96	SUMMIT	Sedan
F	96	MITSUBISHI	MIRAGE Todos Fab. hasta 5/96
F	95	MIRAGE	Sedan
F	93-94	MIRAGE	Todos
F	93-94	PLYMOUTH	COLT Sedan
142330 W			
F	98-02	SUBARU	FORESTER Todos
F	93-01	IMPREZA	Non-ABS
F	90-04	LEGACY	Todos
142393 X			
R	95-99	DODGE	NEON Todos

Bases de Struts

Amort.	POP	No. Alternativo	Montaje Accesorio
Pos.	Año	Aplicación	
142393 X -continued			
R	95-99	PLYMOUTH	NEON Todos
142402 X			
R	95-00	FORD	CONTOUR Todos
R	99-00	MERCURY	COUGAR Todos
R	95-00	MYSTIQUE	Todos
142405 X			
R	88-91	BUICK	REATAA Todos
R	86-93	RIVIERA	Todos
R	87-92	CADILLAC	ALLANTE Todos Exc. Suspensión Electrónica Ajustable
R	86-93	ELDORADO	Todos
R	86-93	SEVILLE	Todos
R	86-92	OLDSMOBILE	TORONADO Todos
142412 X			
F	93-02	CHEVROLET	CAMARO Todos
F	93-02	PONTIAC	FIREBIRD Todos
142413 D			
R	95-05	CHEVROLET	CAVALIER Todos
R	95-05	PONTIAC	SUNFIRE Todos
142419 D			
R	01-05	CHRYSLER	SEBRING ST (Código plataforma del fabricante), Coupe
F	96-00	SEBRING	Coupe
R	96-00	SEBRING	Coupe
F	95	SEBRING	Todos
R	95	SEBRING	Todos
R	89	DODGE	2000 GTX Todos Exc. Sistema de Autonivelación
F	95-00	AVENGER	Todos
R	95-00	AVENGER	Todos
R	92-95	COLT	Todos
R	89-91	COLT	Hatchback
R	91-96	STEALTH	Todos
R	01-05	STRATUS ST	(Código plataforma del fabricante), Coupe
R	91-93	EAGLE	2000 GTX Todos
R	93-96	SUMMIT	Todos
R	89-92	SUMMIT	Sedan
R	92	SUMMIT	Wagon
F	95-98	TALON	Todos
R	90-98	TALON	Todos
R	06-11	HYUNDAI	ACCENT Todos
R	92-95	ELANTRA	Non-ABS
F	00-05	SONATA	Todos
R	00-05	SONATA	Todos
R	01	XG300	Todos
R	02-05	XG350	Todos
R	01-06	KIA	MAGENTIS Todos
R	01-06	OPTIMA	Todos
R	06-11	RIO	Todos
R	06-11	RIO	Todos
R	91-99	MITSUBISHI	3000GT Todos
R	97-04	DIAMANTE	Todos
R	90-05	ECLIPSE	Todos
F	95-99	ECLIPSE	Todos
R	92-95	EXPO	Todos
R	89-07	GALANT	Todos
F	94-98	GALANT	Todos
R	85-88	GALANT	Todos Exc. Suspensión Electrónica Ajustable
R	97-02	MIRAGE	Todos
R	96	MIRAGE	Todos Fab. hasta 5/96
R	95	MIRAGE	Sedan
R	89-94	MIRAGE	Todos
R	89-90	SIGMA	Non-ABS Exc. Sistema de Autonivelación
R	89-94	PLYMOUTH	COLT Todos
R	90-94	LASER	Todos
142427 X			
R	90-94	NISSAN	AXXESS Todos Derecho
R	89-94	MAXIMA	Todos Derecho Exc. Suspensión Electrónica Ajustable
R	86-88	MAXIMA	Sedan Derecho Exc. Suspensión Electrónica Ajustable
R	85	MAXIMA	Todos Derecho Exc. Suspensión Electrónica Ajustable
R	87-88	MULTI	Todos Derecho
R	90-92	STANZA	Todos Derecho
R	87-89	STANZA	Sedan Derecho
142430 X			
F	89-94	NISSAN	240SX Todos Exc. Suspensión Activa
142437 X			
F	85-92	TOYOTA	CRESSIDA Todos Exc. Suspensión Electrónica Ajustable
F	86	SUPRA	Todos Fab. hasta 3/86

Lista numérica

Amort.	POP	No. Alternativo	Montaje Accesorio
Pos.	Año	Aplicación	
142439 W			
R	95-96	TOYOTA	AVALON Todos
R	92-96	CAMRY	Todos
142524 X			
F	05-09	BUICK	ALLURE Todos
F	97-05	CENTURY	Todos
F	05-09	LACROSSE	Todos
F	97-05	LESABRE	Todos
F	97-05	PARK AVENUE	Todos
F	97-04	REGAL	Todos
F	98-99	RIVIERA	Todos
F	98-04	CADILLAC	SEVILLE Todos
F	00-11	CHEVROLET	IMPALA Todos
F	00-06	MONTE CARLO	Todos
F	02-05	VENTURE	Todos
F	97-01	VENTURE 4x2	Tracción delantera
F	97-99	OLDSMOBILE	88 SERIES Todos
F	97	AURORA	Todos
F	98-02	INTRIGUE	Todos
F	96-99	LSS	Todos
F	97-98	REGENCY	Todos
F	97-04	SILHOUETTE	Todos
F	97-08	PONTIAC	GRAND PRIX Todos
F	04-05	MONTANA	Todos
F	02-03	MONTANA	Mini Passenger Van
F	99-01	MONTANA	Todos
F	97-98	TRANS SPORT	Todos
142525 W			
F	05-09	BUICK	ALLURE Todos
F	97-05	CENTURY	Todos
F	05-09	LACROSSE	Todos
F	97-04	REGAL	Todos
F	00-16	CHEVROLET	IMPALA Todos
F	00-06	MONTE CARLO	Todos
F	02-05	VENTURE	Todos
F	97-01	VENTURE 4x2	Tracción delantera
F	98-02	OLDSMOBILE	INTRIGUE Todos
F	97-04	SILHOUETTE	Todos
F	97-08	PONTIAC	GRAND PRIX Todos
F	99-05	MONTANA	Todos
F	97-98	TRANS SPORT	Todos
142526 D			
F	05-09	BUICK	ALLURE Todos
F	97-05	CENTURY	Todos
F	05-09	LACROSSE	Todos
F	97-04	REGAL	Todos
F	05-07	TERRAZA 4x2	Tracción delantera
F	00-16	CHEVROLET	IMPALA Todos
F	00-07	MONTE CARLO	Todos
F	05-09	UPLANDER 4x2	Tracción delantera
F	02-05	VENTURE	Todos
F	97-01	VENTURE 4x2	Tracción delantera
F	98-02	OLDSMOBILE	INTRIGUE Todos
F	97-04	SILHOUETTE	Todos
F	01-05	PONTIAC	AZTEK Todos
F	97-08	GRAND PRIX	Todos
F	99-09	MONTANA	Todos
F	97-98	TRANS SPORT	Todos
F	05-07	SATURN	RELAY Todos
142527 X			
F	97-99	CADILLAC	DEVILLE Todos Control de Manejo Electrónico
F	97-02	ELDORADO	Todos Control de Manejo Electrónico
F	93-97	SEVILLE	Todos
142532 X			
R	04-05	CHEVROLET	CLASSIC Todos
R	97-03	MALIBU	Todos
R	99-04	OLDSMOBILE	ALERO Todos
R	97-99	CUTLASS / CUTLASS SUPREME	Todos
R	99-05	PONTIAC	GRAND AM Todos
142535 W			
R	96-06	HYUNDAI	ELANTRA Todos Izquierdo
R	03-08	TIBURON	Todos Izquierdo
R	97-01	TIBURON	Todos Izquierdo
R	05-12	TUCSON	Todos Izquierdo
R	05-09	KIA	SPECTRA Todos Izquierdo
R	04-09	SPECTRA	Todos Izquierdo
R	05-10	SPORTAGE	Todos Izquierdo
142536 W			
R	96-06	HYUNDAI	ELANTRA Todos Derecho
R	03-08	TIBURON	Todos Derecho
R	97-01	TIBURON	Todos Derecho
R	05-12	TUCSON	Todos Derecho
R	05-09	KIA	SPECTRA Todos Derecho
R	04-09	SPECTRA	Todos Derecho

Lista numérica

Amort.	POP	No. Alternativo	Montaje Accesorio
Pos.	Año	Aplicación	
142536	W	-continued	
R	05-10	SPORTAGE Todos Derecho	
142546	D		
F	96-99	INFINITI I30 Todos	
F	95-99	NISSAN MAXIMA Todos	
142556	X		
F	95-04	TOYOTA AVALON Todos	
F	95-01	CAMRY Todos	
F	94-99	CELICA Todos	
142562	X		
F	91-92	FORD PROBE Base, 2.2L 4Cyl L (133), Automatic	
F	90-92	PROBE GT, 2.2L 4Cyl L (133), Automatic	
F	89-92	PROBE GL, 2.2L 4Cyl L (133), Automatic	
F	89	PROBE LX, 2.2L 4Cyl L (133), Automatic	
F	88-92	MAZDA 626 Automatic Exc. Suspensión Electrónica Ajustable o con dirección en las 4 ruedas	
F	88-89	929 Todos Exc. Suspensión Electrónica Ajustable	
F	00-06	MPV Todos	
F	88-92	MX6 Automatic Exc. Suspensión Electrónica Ajustable o con dirección en las 4 ruedas	
142567	W		
F	86-93	CHRYSLER DAYTONA Todos	
F	88-93	DYNASTY Todos Exc. Sistema de Autonivelación NIVOMAT	
F	90-93	IMPERIAL Todos	
F	90-93	IMPERIAL Todos Exc. Sistema de Autonivelación NIVOMAT	
F	86	LASER Todos	
F	86-95	LEBARON Todos	
F	86-93	NEW YORKER Todos	
F	90-95	TOWN & COUNTRY Todos	
F	86-88	TOWN & COUNTRY Todos	
F	86-88	DODGE 600 Todos	
F	86-89	ARIES Todos	
F	86-95	CARAVAN / GRAND CARAVAN Todos	
F	86-93	DAYTONA Todos	
F	88-93	DYNASTY Todos Exc. Sistema de Autonivelación NIVOMAT	
F	86-89	LANCER Todos	
F	87-94	SHADOW Todos	
F	89-95	SPIRIT Todos	
F	89-95	PLYMOUTH ACCLAIM Todos	
F	86-88	CARAVELLE Todos	
F	86-89	RELIANT Todos	
F	87-94	SUNDANCE Todos	
F	86-95	VOYAGER / GRAND VOYAGER Todos	
142568	W		
F	86-93	CHRYSLER DAYTONA Todos	
F	88-93	DYNASTY Todos Exc. Sistema de Autonivelación NIVOMAT	
F	90-93	IMPERIAL Todos Exc. Sistema de Autonivelación NIVOMAT	
F	86	LASER Todos	
F	86-95	LEBARON Todos	
F	86-93	NEW YORKER Todos	
F	90-95	TOWN & COUNTRY Todos	
F	86-88	TOWN & COUNTRY Todos	
F	86-88	DODGE 600 Todos	
F	86-89	ARIES Todos	
F	89-95	CARAVAN / GRAND CARAVAN Todos Fab. desde 1/86	
F	86-95	CARAVAN / GRAND CARAVAN Todos	
F	89-93	DAYTONA Todos	
F	87-88	DAYTONA Pacifica	
F	86	DAYTONA Todos	
F	88-93	DYNASTY Todos Exc. Sistema de Autonivelación NIVOMAT	
F	86-89	LANCER Todos	
F	87-94	SHADOW Todos	
F	89-95	SPIRIT Todos	
F	89-95	PLYMOUTH ACCLAIM Todos	
F	86-88	CARAVELLE Todos	
F	86-89	RELIANT Todos	
F	87-94	SUNDANCE Todos	
F	86-95	VOYAGER / GRAND VOYAGER Todos	
142573	X		
R	85-98	VOLKSWAGEN GOLF Todos	
R	87-98	GTI	
R	85-98	JETTA Todos	

Bases de Struts

Amort.	POP	No. Alternativo	Montaje Accesorio
Pos.	Año	Aplicación	
142623	C		
F	95-98	NISSAN 200SX Todos	
F	91-93	NX Todos	
F	93-99	SENTRA Todos	
F	91-92	SENTRA Non-ABS	
142625	W		
F	96-06	HYUNDAI ELANTRA Todos	
F	97-01	TIBURON Todos	
142626	X		
R	88-92	DAIHATSU CHARADE Todos	
R	95-05	HYUNDAI ACCENT Todos	
142640	X		
F	00-05	BUICK LESABRE Todos	
F	98-05	PARK AVENUE Todos	
F	98-99	RIVIERA Todos	
F	97-05	CADILLAC DEVILLE Todos Exc. Suspensión Electrónica Ajustable	
F	98-04	SEVILLE Todos Exc. Suspensión Electrónica Ajustable	
F	01-03	OLDSMOBILE AURORA Todos	
F	98-99	AURORA Todos	
F	00-05	PONTIAC BONNEVILLE Todos	
142641	X		
R	94-01	KIA SEPHIA Todos Derecho	
R	00	SEPHIA Todos Derecho Fab. hasta 6/01	
142642	X		
R	94-01	KIA SEPHIA Todos Izquierdo	
R	00	SEPHIA Todos Izquierdo Fab. hasta 6/01	
142647	X		
R	00-05	BUICK LESABRE Todos	
R	97-05	PARK AVENUE Todos	
R	95-99	RIVIERA Todos	
R	00-05	CADILLAC DEVILLE Todos Exc. Suspensión Electrónica Ajustable	
R	98-04	SEVILLE Todos Exc. Suspensión Electrónica Ajustable	
R	01-03	OLDSMOBILE AURORA Todos	
R	95-99	AURORA Todos	
R	00-05	PONTIAC BONNEVILLE Todos	
142649	X		
F	97-01	LEXUS ES300 Todos Derecho Exc. Suspensión Adaptable Variable	
F	99-03	RX300 Todos Derecho	
F	97-04	TOYOTA AVALON Todos Derecho	
F	97-01	CAMRY Todos Derecho	
F	03	SIENNA Todos Derecho	
F	02	SIENNA Todos Derecho Fab. hasta 12/02	
F	98-01	SIENNA Todos Derecho	
F	99-03	SOLARA Todos Derecho	
142650	X		
F	97-01	LEXUS ES300 Todos Izquierdo Exc. Suspensión Adaptable Variable	
F	99-03	RX300 Todos Izquierdo	
F	97-04	TOYOTA AVALON Todos Izquierdo	
F	97-01	CAMRY Todos Izquierdo	
F	98-03	SIENNA Todos Izquierdo	
F	99-03	SOLARA Todos Izquierdo	
142651	C		
F	00-06	AUDI TT Todos	
F	00-06	TT QUATTRO Todos	
F	98-11	VOLKSWAGEN BEETLE Todos	
F	99-11	GOLF	
F	99-11	GTI	
F	06-12	JETTA Todos A4 Sedan	
F	99-12	JETTA Todos Clásico	
F	99-05	JETTA A4 (Código plataforma del fabricante), Sedan	
142652	W		
F	96-08	AUDI A4 Todos	
F	98-04	A6 Todos	
F	98-07	A6 QUATTRO Todos	
F	97-99	A8 Todos	
F	00-02	S4 Todos	
F	98-09	VOLKSWAGEN PASSAT Todos	
142654	D		
R	00-06	AUDI TT Todos	
R	98-10	VOLKSWAGEN BEETLE Todos	
R	99-11	GOLF	
R	99-11	GTI	
R	06-12	JETTA Todos	
R	99-12	JETTA Todos Clásico	
R	99-05	JETTA A4 (Código plataforma del fabricante), Sedan	

Lista numérica

Amort.	POP	No. Alternativo	Montaje Accesorio
Pos.	Año	Aplicación	
142735	X		
R	92-95	BMW 525i Todos Exc. Suspensión Electrónica Ajustable	
R	89-91	525i Todos	
R	94-95	530i Sedan	
R	88-93	535i Todos	
R	88	535iS Todos	
142744	X		
F	91-03	FORD ESCORT Todos	
F	91-99	MERCURY TRACER 4x2 Tracción delantera	
142746	X		
F	86-95	FORD TAURUS Todos	
F	91-95	MERCURY SABLE Sedan	
F	86-90	SABLE Todos	
142749	X		
F	85-96	BUICK CENTURY Todos	
F	85	SKYLARK Todos	
F	84-90	CHEVROLET CELEBRITY Todos	
F	84-85	CITATION / CITATION II Todos	
F	90-96	LUMINA APV Todos	
F	82-96	OLDSMOBILE CIERA / CUTLASS CIERA Todos	
F	87-94	CUTLASS CLASSIC / CUTLASS CRUISER Todos	
F	90-96	SILHOUETTE Todos	
F	91	PONTIAC 6000 4x2 Tracción delantera	
F	84-90	6000 Todos	
F	84	PHOENIX Todos	
F	90-96	TRANS SPORT Todos	
142751	X		
F	91-99	BUICK LESABRE Todos	
F	91-96	PARK AVENUE Todos	
F	95-97	RIVIERA Todos	
F	93	CADILLAC 60 SPECIAL Todos	
F	92-93	COMMERCIAL CHASSIS 4x2 Tracción delantera	
F	91	COMMERCIAL CHASSIS Todos	
F	91-93	DEVILLE Todos	
F	91-93	FLEETWOOD Todos	
F	90-99	OLDSMOBILE 88 SERIES Todos	
F	91-96	98 Todos Exc. Suspensión Soft Ride (FE1) y Elect. Ride y Handling (FW1)	
F	91-96	98 Coil (FrontSpringType), Air (RearSpringType) Equipamiento Estándar; Exc. Suspensión Elec. Ajustable	
F	95-96	AURORA Todos	
F	96-99	LSS Todos	
F	97-98	REGENCY Todos	
F	90-99	PONTIAC BONNEVILLE Todos	
142752	X		
F	86-90	BUICK LESABRE Todos	
F	85-90	CADILLAC COMMERCIAL CHASSIS Todos	
F	85-90	DEVILLE Todos	
F	87-90	FLEETWOOD Todos	
F	86-89	OLDSMOBILE 88 SERIES Todos	
F	85-90	98 Todos	
F	87-89	PONTIAC BONNEVILLE Todos	
142753	X		
F	96-00	CHRYSLER TOWN & COUNTRY Todos	
F	00	VOYAGER / GRAND VOYAGER Todos	
F	96-00	DODGE CARAVAN / GRAND CARAVAN Todos	
F	96-00	CARAVAN / GRAND CARAVAN Todos Exc. Sistema de Autonivelación NIVOMAT	
F	96-00	PLYMOUTH VOYAGER / GRAND VOYAGER Todos Exc. Opción de Autonivelación Nivomat	
142755	X		
F	93-97	CHRYSLER CONCORDE Todos	
F	94-97	LHS Todos	
F	94-96	NEW YORKER Todos	
F	93-97	DODGE INTREPID Todos	
F	93-97	EAGLE VISION Todos	
142762	X		
F	82-89	BUICK SKYHAWK Todos	
F	86-91	SKYLARK Todos	
F	85-87	SOMERSET / SOMERSET REGAL Todos	
F	82-88	CADILLAC CIMARRON Todos	
F	87-91	CHEVROLET BERETTA Todos	
F	82-94	CAVALIER Todos	

Lista numérica

Amort.	POP	No. Alternativo	Montaje Accesorio
Pos.	Año	Aplicación	
142762	X	-continued	
F	87-91	CORSICA Todos	
F	85-87	OLDSMOBILE CALAIS Todos	
F	88-91	CUTLASS CALAIS Todos	
F	82-87	FIRENZA Todos	
F	85-91	PONTIAC GRAND AM Todos Suspensión Estándar	
F	82-84	J2000 / SUNBIRD Todos	
F	86-94	SUNBIRD Todos	
142826	X		
F	95-99	BMW M3 Todos Izquierdo	
142827	W		
F	99-04	CHRYSLER 300M Todos	
F	98-04	CONCORDE Todos	
F	98-04	INTREPID Todos	
F	99-01	LHS Todos	
F	98-04	DODGE INTREPID Todos	
142828	X		
R	99-04	CHRYSLER 300M Todos	
R	98-04	CONCORDE Todos	
R	98-04	INTREPID Todos	
R	99-01	LHS Todos	
R	98-04	DODGE INTREPID Todos	
142832	X		
F	97-03	FORD ESCORT Todos	
F	97-99	MERCURY TRACER 4x2 Tracción delantera	
142836	X		
F	95-96	LEXUS ES300 Todos	
F	95-96	TOYOTA AVALON Todos	
F	95-96	CAMRY Todos	
142837	W		
R	97-02	LEXUS ES300 Todos Exc. Suspensión Adaptable Variable	
R	99-03	RX300 Todos	
R	97-04	TOYOTA AVALON Todos	
R	97-03	CAMRY Todos	
R	99-03	SOLARA Todos	
142838	W		
F	90-02	TOYOTA 4RUNNER Todos Exc. HD	
142840	X		
F	95-99	DODGE NEON Todos	
F	95-99	PLYMOUTH NEON Todos	
142841	D		
F	96-00	CHRYSLER TOWN & COUNTRY Todos	
F	00	VOYAGER / GRAND VOYAGER Todos	
F	96-00	DODGE CARAVAN / GRAND CARAVAN Todos Exc. Sistema de Autonivelación NIVOMAT	
F	96-00	PLYMOUTH VOYAGER / GRAND VOYAGER Todos Exc. Opción de Autonivelación Nivomat	
142842	X		
F	93-97	CHRYSLER CONCORDE Todos	
F	93-97	INTREPID Todos	
F	94-97	LHS Todos	
F	94-96	NEW YORKER Todos	
F	93-97	DODGE INTREPID Todos	
F	93-97	EAGLE VISION Todos	
142843	W		
F	95-00	FORD CONTOUR Todos	
F	99-02	MERCURY COUGAR Todos	
F	95-00	MYSTIQUE Todos	
142851	X		
F	95-98	MAZDA PROTÉGÉ / PROTÉGÉ5 Todos	
142856	X		
F	93-97	FORD PROBE Todos	
F	98-01	KIA SEPHIA Todos	
F	93-97	MAZDA 626 Todos	
F	93-97	MX6 Todos	
142860	X		
F	93-01	MERCURY VILLAGER Todos	
F	93-02	NISSAN QUEST Todos	
142861	X		
F	86-88	NISSAN MULTI Todos	
F	86-90	PULSAR / PULSAR NX Todos	
F	91-92	SENTRA Classic, 4x2 Tracción delantera	
F	87-90	SENTRA 4x2 Tracción delantera	

Bases de Struts

Amort.	POP	No. Alternativo	Montaje Accesorio
Pos.	Año	Aplicación	
142861	X	-continued	
F	85-89	STANZA Sedan	
142880	X		
F	86-93	CHRYSLER DAYTONA Todos	
F	88-93	DYNASTY Todos	
F	90-93	IMPERIAL Todos	
F	86	LASER Todos	
F	86-95	LEBARON Todos	
F	86-93	NEW YORKER Todos	
F	90-95	TOWN & COUNTRY Todos	
F	86-88	TOWN & COUNTRY Todos	
F	86-88	DODGE 600 Todos	
F	86-89	ARIES Todos	
F	86-95	CARAVAN / GRAND CARAVAN Todos	
F	89-93	DAYTONA Todos	
F	87-88	DAYTONA Pacífica	
F	86	DAYTONA Todos	
F	88-93	DYNASTY Todos	
F	86-89	LANCER Todos	
F	87-94	SHADOW Todos	
F	89-95	SPIRIT Todos	
F	89-95	PLYMOUTH ACCLAIM Todos	
F	86-88	CARAVELLE Todos	
F	86-89	RELIANT Todos	
F	87-94	SUNDANCE Todos	
F	86-95	VOYAGER / GRAND VOYAGER Todos	
142930	C		
F	00-11	FORD FOCUS Todos	
142931	C		
F	04-08	CHRYSLER PACIFICA Todos	
F	01-07	TOWN & COUNTRY Todos	
F	01-07	VOYAGER / GRAND VOYAGER Todos	
F	01-07	DODGE CARAVAN / GRAND CARAVAN Todos	
142932	D		
F	00-02	CHRYSLER NEON Todos	
F	01-10	PT CRUISER Todos	
F	00-05	DODGE NEON Todos	
F	00-01	PLYMOUTH NEON Todos	
142933	X		
F	86-93	CHRYSLER DAYTONA Todos	
F	88-93	DYNASTY Todos	
F	90-93	IMPERIAL Todos	
F	86	LASER Todos	
F	86-95	LEBARON Todos	
F	86-93	NEW YORKER Todos	
F	90-95	TOWN & COUNTRY Todos	
F	86-88	DODGE 600 Todos	
F	86-89	ARIES Todos	
F	86-95	CARAVAN / GRAND CARAVAN Todos	
F	89-93	DAYTONA Todos	
F	87-88	DAYTONA Pacífica	
F	86	DAYTONA Todos	
F	88-93	DYNASTY Todos	
F	86-89	LANCER Todos	
F	87-94	SHADOW Todos	
F	89-95	SPIRIT Todos	
F	89-95	PLYMOUTH ACCLAIM Todos	
F	86-88	CARAVELLE Todos	
F	86-89	RELIANT Todos	
F	87-94	SUNDANCE Todos	
F	86-95	VOYAGER / GRAND VOYAGER Todos	
142935	W		
F	00-05	HYUNDAI ACCENT Todos	
142936	X		
F	00-01	NISSAN SENTRA Todos	
142937	D		
F	03-08	INFINITI FX35 Todos	
F	03-08	FX45 Todos	
F	00-01	I30 Todos	
F	00-01	I30 Todos Kit w/ Mount and Bearing	
F	02-04	I35 Todos	
F	02-04	I35 Todos Kit w/ Mount and Bearing	
F	02-06	NISSAN ALTIMA Todos	
F	02-06	ALTIMA Todos Kit w/ Mount and Bearing	
F	00-08	MAXIMA Todos	
F	00-08	MAXIMA Todos Kit w/ Mount and Bearing	
F	03-07	MURANO Todos	
F	03-07	MURANO Todos Kit w/ Mount and Bearing	
F	04-09	QUEST Todos	

Lista numérica

Amort.	POP	No. Alternativo	Montaje Accesorio
Pos.	Año	Aplicación	
142937	D	-continued	
F	04-09	QUEST Todos Kit w/ Mount and Bearing	
142938	W		
F	97-03	INFINITI QX4 Todos	
F	96-03	NISSAN PATHFINDER Todos	
142940	X		
F	86-93	CHRYSLER DAYTONA Todos	
F	88-93	DYNASTY Todos Exc. Sistema de Autonivelación NIVOMAT	
F	90-93	IMPERIAL Todos Exc. Sistema de Autonivelación NIVOMAT	
F	86	LASER Todos Fab. desde 02/Enero/86	
F	87-95	LEBARON Todos	
F	86	LEBARON Todos Fab. desde 02/Enero/86	
F	87-93	NEW YORKER Todos	
F	86	NEW YORKER Todos Fab. desde 02/Enero/86	
F	90-95	TOWN & COUNTRY Todos	
F	88	DODGE 600 Todos	
F	86-87	600 Todos Fab. desde 02/Enero/86	
F	86-89	ARIES Todos	
F	86-95	CARAVAN / GRAND CARAVAN Todos	
F	90	CARAVAN / GRAND CARAVAN Todos Fab. desde 02/Enero/86	
F	89-93	DAYTONA ES	
F	89-90	DAYTONA ES Turbo	
F	87-88	DAYTONA Pacífica	
F	86	DAYTONA Todos	
F	88-93	DYNASTY Todos Exc. Sistema de Autonivelación NIVOMAT	
F	87-89	LANCER Todos	
F	86	LANCER Todos Fab. desde 02/Enero/86	
F	87-94	SHADOW Todos	
F	89-95	SPIRIT Todos	
F	89-95	PLYMOUTH ACCLAIM Todos	
F	87-88	CARAVELLE Todos	
F	86	CARAVELLE Todos Fab. desde 02/Enero/86	
F	86-89	RELIANT Todos	
F	87-94	SUNDANCE Todos	
142941	W		
R	93-97	VOLVO 850 Todos Exc. Sistema de Autonivelación NIVOMAT	
R	98-04	C70 Todos	
R	98-00	S70 Todos	
R	99-00	V70 R AWD Exc. Autonivelación Trasera	
R	98-00	V70 Base Exc. Autonivelación Trasera	
R	98-00	V70 GLT Exc. Autonivelación Trasera	
R	98-00	V70 T5 Exc. Autonivelación Trasera	
R	00	V70 2.4T Exc. Autonivelación Trasera	
R	00	V70 GLT SE Exc. Autonivelación Trasera	
R	98-99	V70 AWD Exc. Autonivelación Trasera	
R	98	V70 R Exc. Autonivelación Trasera	
142943	X		
F	01-02	SATURN L / LS / LW SERIES Todos	
142949	W		
R	00-03	NISSAN MAXIMA Todos	
142992	W		
R	08-11	FORD FOCUS Todos	
R	00-07	FOCUS Hatchback	
R	00-07	FOCUS Sedan	
143035	X		
F	99-05	CHEVROLET CAVALIER Todos	
F	99-05	PONTIAC SUNFIRE Todos	
F	02-07	SATURN VUE Todos	
143073	X		
R	05-09	BUICK ALLURE Todos Izquierdo	
R	97-05	CENTURY Todos Izquierdo	
R	05-09	LACROSSE Todos Izquierdo	
R	97-04	REGAL Todos Izquierdo	
R	00-11	CHEVROLET IMPALA Todos Izquierdo	
R	95-01	LUMINA Todos Izquierdo	
R	95-07	MONTE CARLO Todos Izquierdo	
R	98-02	OLDSMOBILE INTRIGUE Todos Izquierdo	

Lista numérica

Amort.	POP	No. Alternativo	Montaje Accesorio
Pos.	Año	Aplicación	
143073	X	-continued	
R	97-08	PONTIAC GRAND PRIX Todos Izquierdo	
143074	X		
R	05-09	BUICK ALLURE Todos Derecho	
R	97-05	CENTURY Todos Derecho	
R	05-09	LACROSSE Todos Derecho	
R	97-04	REGAL Todos Derecho	
R	00-11	CHEVROLET IMPALA Todos Derecho	
R	97-07	MONTE CARLO Todos Derecho	
R	98-02	OLDSMOBILE INTRIGUE Todos Derecho	
R	97-08	PONTIAC GRAND PRIX Todos Derecho	
143082	W		
F	00	BMW 323CI Coupe	
F	00	323I Wagon	
F	01-06	325CI Todos Suspensión Deportiva; Exc. M-Sport Pack II	
F	01-06	325I Todos Exc. Suspensión Deportiva M-Sport Pack II	
F	00	328CI Todos	
F	99-00	328I Todos	
F	01-06	330CI Todos Exc. Suspensión Deportiva M-Sport Pack II	
F	97-00	528I Todos	
143084	W		
F	00-06	BMW X5 AWD	
143086	W		
F	96-06	MERCEDES-BENZ E320 Todos Exc. 4 Matic	
F	97	E420 Todos Exc. 4 Matic	
F	98-02	E430 Todos Exc. 4 Matic	
143087	W		
F	01-05	CHRYSLER SEBRING ST (Código plataforma del fabricante), Coupe	
F	01-05	DODGE STRATUS ST (Código plataforma del fabricante), Coupe	
F	01-04	HYUNDAI SANTA FE Todos	
F	05-10	TUCSON Todos	
F	97-04	MITSUBISHI DIAMANTE Todos	
F	00-05	ECLIPSE Todos	
F	99-03	GALANT Todos	
143088	D		
F	02-07	MITSUBISHI LANCER Todos	
F	03-06	OUTLANDER Todos	
143089	W		
F	04-07	SATURN ION Todos	
143091	D		
F	02-07	BUICK RENDEZVOUS Todos Exc. Sistema de Autonivelación NIVOMAT	
143092	D		
F	03-07	CADILLAC CTS Todos	
143093	D		
F	03-08	PONTIAC VIBE Todos	
F	03-08	TOYOTA MATRIX Todos	
143094	D		
R	03-08	PONTIAC VIBE Todos	
R	05-07	SCION TC Todos	
R	00-05	TOYOTA CELICA Todos	
R	03-08	COROLLA Todos	
R	03-08	MATRIX Todos	
R	01-09	PRIUS Todos	
143112	X		
R	98-02	MAZDA 626 Todos Derecho	
143140	W		
R	03-06	SUBARU BAJA Todos	
R	00-07	LEGACY Todos	
R	00-05	OUTBACK Todos	
143191	W		
F	94-97	VOLVO 850 Wagon Exc. Sistema de Autonivelación NIVOMAT	
F	93-97	850 Sedan Exc. Sistema de Autonivelación NIVOMAT	
F	06-07	C70 Todos	
F	98-04	C70 Todos	
F	01-07	S60 Todos	
F	98-00	S70 Todos	
F	99-06	S80 Todos Exc. Suspensión Trasera Nivomat	
F	06-07	V70 R, AWD	

Bases de Struts

Amort.	POP	No. Alternativo	Montaje Accesorio
Pos.	Año	Aplicación	
143191	W	-continued	
F	04-05	V70 2.4	
F	04-05	V70 2.5T	
F	04-05	V70 R	
F	01-05	V70 T5	
F	04	V70 2.5T AWD	
F	01-03	V70 2.4T	
F	01-03	V70 Base	
F	02	V70 AWD	
F	99-00	V70 R AWD Exc. Autonivelación Trasera	
F	98-00	V70 Base Exc. Autonivelación Trasera	
F	98-00	V70 GLT Exc. Autonivelación Trasera	
F	98-00	V70 T5 Exc. Autonivelación Trasera	
F	00	V70 2.4T Exc. Autonivelación Trasera	
F	00	V70 GLT SE Exc. Autonivelación Trasera	
F	98-99	V70 AWD Exc. Autonivelación Trasera	
F	98	V70 R Exc. Autonivelación Trasera	
F	04-06	XC90 Todos	
F	03	XC90 AWD	
143193	W		
F	01-03	TOYOTA PRIUS Todos	
143194	W		
F	00-05	TOYOTA ECHO Todos Sólo aplica para Número de EO 48609-52011 y 48609-52050	
143195	W		
F	00-05	TOYOTA ECHO Todos Sólo aplica para Número de EO 48609-52021	
143197	X		
R	90-94	LEXUS LS400 Todos Exc. Sistema de Autonivelación	
143198	W		
R	95-00	LEXUS LS400 Todos Exc. Sistema de Autonivelación	
143199	X		
F	90-94	LEXUS LS400 Todos Exc. Sistema de Autonivelación	
143200	W		
F	93-05	LEXUS GS300 Todos	
F	98-00	GS400 Todos	
F	01-05	GS430 Todos	
F	02-07	SC430 Todos	
143201	D		
F	00-05	TOYOTA CELICA Todos	
F	03-08	COROLLA Todos	
F	04-09	PRIUS Todos	
143202	W		
F	02-03	LEXUS ES300 Todos Exc. Suspensión Adaptable Variable	
F	04-06	ES330 Todos Exc. Suspensión Adaptable Variable	
F	04-06	RX330 Todos	
F	06-07	RX400H Todos	
F	02-06	TOYOTA CAMRY Todos	
F	01-07	HIGHLANDER Todos	
F	04-08	SIENNA Todos	
F	04-07	SOLARA Todos	
143204	W		
F	99-04	CHEVROLET TRACKER Non-ABS	
F	99-05	SUZUKI GRAND VITARA 2.5L 6Cyl V (2500)	
F	04	VITARA 2.5L 6Cyl V (2500)	
F	99-03	VITARA 2.0L 4Cyl L (2000)	
F	02-06	XL-7 Todos	
143205	W		
R	03-06	SUBARU FORESTER Todos	
R	04-06	IMPREZA Todos	
143206	X		
F	01-02	SAAB 9-3 Turbo	
F	99-02	9-3 SE	
F	99-01	9-3 Base	
143209	C		
R	00-06	NISSAN SENTRA Todos	
143210	X		
F	97-05	INFINITI Q45 Todos Exc. Suspensión Activa	

Lista numérica

Amort.	POP	No. Alternativo	Montaje Accesorio
Pos.	Año	Aplicación	
143214	D		
R	02-07	NISSAN ALTIMA Todos	
R	04-08	MAXIMA Todos	
143218	W		
F	98-02	MAZDA 626 Todos	
143219	X		
F	03	MAZDA PROTÉGÉ / PROTÉGÉS DX	
F	03	PROTÉGÉ / PROTÉGÉS ES	
F	03	PROTÉGÉ / PROTÉGÉS LX	
F	03	PROTÉGÉ / PROTÉGÉS SE	
F	99-02	PROTÉGÉ / PROTÉGÉS Todos	
143221	W		
R	99-03	MAZDA PROTÉGÉ / PROTÉGÉS Todos Izquierdo	
R	03	PROTÉGÉ / PROTÉGÉS DX Izquierdo	
R	03	PROTÉGÉ / PROTÉGÉS ES Izquierdo	
R	03	PROTÉGÉ / PROTÉGÉS LX Izquierdo	
R	03	PROTÉGÉ / PROTÉGÉS SE Izquierdo	
143223	W		
R	99-03	MAZDA PROTÉGÉ / PROTÉGÉS Todos Derecho	
R	03	PROTÉGÉ / PROTÉGÉS DX Derecho	
R	03	PROTÉGÉ / PROTÉGÉS ES Derecho	
R	03	PROTÉGÉ / PROTÉGÉS LX Derecho	
R	03	PROTÉGÉ / PROTÉGÉS SE Derecho	
143224	W		
F	03-04	MAZDA 6 Todos	
143226	W		
F	03-06	KIA SORENTO Todos	
143228	X		
F	95-02	KIA SPORTAGE Todos	
143233	X		
F	05-06	ACURA RSX Type-S Izquierdo	
F	02-05	HONDA CIVIC Coupe Izquierdo	
F	02-05	CIVIC Sedan Izquierdo	
143239	D		
F	06-11	CHEVROLET AVEO Todos	
F	04-12	AVEO Todos	
F	06-10	PONTIAC G2	
F	09-10	G3 Todos	
F	05-08	WAVE Todos	
143241	D		
F	04-07	BUICK RAINIER Todos	
F	03-06	CHEVROLET SSR Todos	
F	02-09	TRAILBLAZER Todos	
F	02-09	GMC ENVOY Todos	
F	03-08	ISUZU ASCENDER Todos	
F	02-04	OLDSMOBILE BRAVADA Todos	
F	05-09	SAAB 9-7X Todos	
143242	W		
F	02-05	FORD THUNDERBIRD Todos	
R	02-05	THUNDERBIRD Todos	
F	00-06	JAGUAR S TYPE Todos Exc. Suspensión de Tecnología Computarizada Activa (CATS)	
R	00-06	S TYPE Todos Exc. Suspensión de Tecnología Computarizada Activa (CATS)	
F	00-06	LINCOLN LS Todos	
R	00-06	LS Todos	
143244	W		
F	03-06	FORD EXPEDITION Todos Exc. Suspensión de Aire	
F	03-05	LINCOLN NAVIGATOR Todos	
143246	W		
F	04-07	FORD FREESTAR Todos	
F	04-07	MERCURY MONTEREY Mini Passenger Van	
143248	W		
F	04-08	FORD LOBO PICK UP	
F	04-08	PICKUP 1/2 TON, F-150 Todos	
F	06-08	LINCOLN MARK LT Todos	

Lista numérica

Amort.	POP	No. Alternativo	Montaje Accesorio
Pos.	Año	Aplicación	
143253	D		
F	01-12	FORD ESCAPE Todos	
F	08-11	MAZDA TRIBUTE Todos	
F	01-06	TRIBUTE Todos	
F	05-11	MERCURY MARINER 4x2 Tracción delantera	
143255	D		
F	02-11	JEEP LIBERTY Todos Izquierdo	
143256	W		
R	00-02	CHRYSLER NEON Todos	
R	00-05	DODGE NEON Todos	
R	00-01	PLYMOUTH NEON Todos	
143259	W		
R	00-06	BMW X5 Todos	
143265	X		
F	05-06	ACURA RSX Type-S Derecho	
F	02-05	HONDA CIVIC Coupe Derecho	
F	02-05	CIVIC Sedan Derecho	
143266	D		
F	02-11	JEEP LIBERTY Todos Derecho	
143267	W		
F	00-06	MAZDA MPV Todos	
143278	X		
F	87-91	TOYOTA CAMRY Todos	
F	91-97	PREVIA Todos	
143280	X		
F	93-97	TOYOTA COROLLA Base	
F	93-97	COROLLA DX	
F	93	COROLLA Todos Trac	
143281	D		
F	98-02	CHEVROLET PRIZM Todos	
F	89-97	GEO PRIZM Todos	
F	90-91	LEXUS ES250 Todos	
F	97-02	TOYOTA COROLLA LE	
F	88-95	COROLLA LE	
F	88-92	COROLLA DLX	
F	88-92	COROLLA DLX Todos Trac	
F	88-92	COROLLA SR5	
F	88-91	COROLLA GTS	
143284	W		
R	02-07	MINI COOPER Todos	
143285	D		
F	06	FORD ECOSPORT	
F	04	ECOSPORT	
F	07-08	ECOSPORT	
F	05	ECOSPORT	
143287	W		
R	98-10	FORD FIESTA	
R	98-08	FIESTA IKON	
143288	W		
F	04-08	FIAT PALIO	
143289	W		
F	04-08	FIAT PALIO	
143290	W		
F	03-08	CHEVROLET VECTRA	
143292	W		
F	04-09	VOLKSWAGEN LUPO	
F	03-07	POLO	
143305	W		
F	12-17	HONDA ODYSSEY Todos From Chassis/VIN CB088499	
F	05-10	ODYSSEY Todos	
F	05-10	ODYSSEY Todos Kit w/ Mount and Bearing	
143309	D		
F	04-09	CHEVROLET AVEO	
F	04-09	PONTIAC G3	
143315	D		
F	01-06	ACURA MDX Todos	
F	99-04	HONDA ODYSSEY Todos	
F	03-08	PILOT Todos	
143316	D		
F	07-13	CADILLAC ESCALADE Todos Exc. Control de Manejo Electrónico	
F	07-13	ESCALADE ESV Todos Exc. Control de Manejo Electrónico	
F	07-13	ESCALADE EXT Todos Exc. Control de Manejo Electrónico	

Bases de Struts

Amort.	POP	No. Alternativo	Montaje Accesorio
Pos.	Año	Aplicación	
143316	D	-continued	
F	07-13	CHEVROLET AVALANCHE 1500 Todos Exc. Control de Manejo Electrónico	
F	07-13	PICKUP 1/2 TON, SILVERADO 1500 Todos Exc. Suspensión Electrónica Ajustable	
F	07-13	SUBURBAN 1/2 TON, 1500 Todos Exc. Suspensión Z55 o ZW7	
F	07-13	TAHOE Todos Exc. Suspensión Z55 o ZW7	
F	07-13	GMC SIERRA 1500 Todos Exc. Suspensión Electrónica Ajustable	
F	07-13	YUKON Todos Exc. Suspensión Electrónica Ajustable	
F	07-13	YUKON XL 1/2 TON Todos Exc. Suspensión Z55 Auto Ride	
143317	X		
R	03-06	FORD EXPEDITION Todos	
143318	W		
F	02-05	FORD EXPLORER Todos	
F	02-05	MERCURY MOUNTAINEER Todos	
143319	W		
R	02-05	FORD EXPLORER Todos	
R	02-05	MERCURY MOUNTAINEER Todos	
143321	D		
R	01-06	CHRYSLER SEBRING JR (Código plataforma del fabricante), Sedan	
R	01-06	DODGE STRATUS Sedan	
143322	C		
F	02-06	NISSAN SENTRA Todos	
143323	W		
F	05-10	CHEVROLET COBALT LS	
F	05-10	COBALT LT	
F	10	COBALT Base	
F	10	COBALT LT Team Canada	
F	06-07	COBALT LTZ	
F	05	COBALT Base	
F	11	HHR Todos	
F	08-10	HHR LS Panel	
F	08-10	HHR LT Panel	
F	06-10	HHR LS	
F	06-10	HHR LT	
F	06-08	HHR Comfort LT	
F	06-08	HHR Elegance LT	
F	07	HHR Edición Especial	
F	07-09	PONTIAC G5 Todos	
F	05-06	PURSUIT Todos	
143324	W		
F	06-08	DODGE PICKUP 1/2 TON, RAM 1500 4x4 Exc. Mega Cab	
143325	W		
F	96-02	TOYOTA 4RUNNER 4x4	
F	01-07	SEQUOIA Todos	
F	95-04	TACOMA 4x4	
F	00-06	TUNDRA Todos	
143328	X		
R	99-00	CHRYSLER CIRRUS Todos	
R	99-00	DODGE STRATUS Todos	
R	99-00	PLYMOUTH BREEZE Todos	
143330	W		
F	06-10	FORD EXPLORER Todos	
F	06-10	MERCURY MOUNTAINEER Todos	
143335	D		
R	05-10	CHRYSLER 300 Todos	
R	08-10	DODGE CHALLENGER Todos	
R	06-10	CHARGER Todos	
R	05-08	MAGNUM Todos	
143336	D		
F	11-14	CHRYSLER 200 Todos	
F	07-10	SEBRING Todos	
F	08-14	DODGE AVENGER Todos	
143337	W		
R	11-14	CHRYSLER 200 Todos	
R	07-10	SEBRING Todos	
R	08-14	DODGE AVENGER Todos	
R	07-12	CALIBER Todos	
R	07-12	JEEP COMPASS Todos	
R	07-12	PATRIOT Todos	
143338	D		
R	04-16	TOYOTA SIENNA Todos	

Lista numérica

Amort.	POP	No. Alternativo	Montaje Accesorio
Pos.	Año	Aplicación	
143339	W		
F	08-15	TOYOTA SEQUOIA Todos	
F	07-16	TUNDRA Todos	
143340	W		
R	08-11	TOYOTA SEQUOIA Todos	
R	07-16	TUNDRA Todos w/Offroad Package	
143341	W		
F	05-07	FORD FREESTYLE Todos	
F	05-10	MUSTANG / MUSTANG II Todos	
F	05-07	MERCURY MONTEGO Todos	
143342	W		
F	06-11	HYUNDAI AZERA Todos	
F	06-10	SONATA Todos	
F	07-09	KIA AMANTI Todos	
143343	FF		
F	06-12	TOYOTA RAV4 4x4	
143344	W		
F	04-12	AUDI A3 Todos	
F	08-09	TT Todos	
F	08-10	TT QUATTRO Todos	
F	09-16	VOLKSWAGEN CC Todos	
F	07-11	EOS Todos	
F	10-13	GOLF Todos Nuevo Modelo	
F	06-13	GTI Todos	
F	10-13	JETTA Todos Nuevo Modelo Exc. TDI	
F	06-09	PASSAT Todos	
F	09-16	PASSAT CC	
F	08	R32 Todos	
F	06-09	RABBIT Todos	
F	09-11	TIGUAN Todos	
143345	W		
R	04-11	AUDI A3 Todos	
R	08-09	TT Todos	
R	08-10	TT QUATTRO Todos	
R	09-16	VOLKSWAGEN CC Todos	
R	07-11	EOS Todos	
R	10-13	GOLF Todos Nuevo Modelo	
R	06-13	GTI Todos	
R	10-13	JETTA Todos Nuevo Modelo Exc. TDI	
R	06-09	JETTA Todos	
R	06-09	PASSAT Todos	
R	09-16	PASSAT CC	
R	08	R32 Todos	
R	06-09	RABBIT Todos	
R	09-11	TIGUAN Todos	
143346	FF		
F	00-07	NISSAN X-TRAIL	
F	02-07	X-TRAIL Todos	
143348	W		
F	04-10	RENAULT MEGANE II	
143349	D		
F	04-10	CHEVROLET OPTRA Todos	
F	06-08	SUZUKI FORENZA Todos	
F	06-08	RENO Todos	
143350	D		
R	04-10	CHEVROLET OPTRA Todos	
R	06-08	SUZUKI FORENZA Todos	
R	06-08	RENO Todos	
143352	W		
F	05-08	DODGE ATTITUDE	
143353	W		
F	02-06	ACURA RSX Base	
F	02-06	RSX Type-S	
F	02-05	HONDA CIVIC Hatchback	
F	01	CIVIC Todos	
F	02-06	CR-V Todos	
F	03-06	ELEMENT Todos	
143354	D		
F	04-12	CHEVROLET MALIBU Todos Izquierdo Exc. Modelos Classic	
F	05-10	PONTIAC G6 Todos Izquierdo	
F	07-09	SATURN AURA Todos Izquierdo	
143355	D		
F	06-12	CHEVROLET MALIBU Todos Derecho Exc. Modelos Classic	
F	05	MALIBU Todos Derecho Exc. modelos Classic	
F	04	MALIBU Todos Derecho Exc. Modelos Classic	
F	05-10	PONTIAC G6 Todos Derecho	
F	07-09	SATURN AURA Todos Derecho	

Lista numérica

Amort.	POP	No. Alternativo	Montaje Accesorio
Pos.	Año	Aplicación	
143356	W		
F	03-11	FORD CROWN VICTORIA Todos	
F	03-11	LINCOLN TOWN CAR Todos Exc. Modelo Limo	
F	03-11	MERCURY GRAND MARQUIS Todos	
143357	X		
F	07-11	FORD CROWN VICTORIA Todos	
F	03-06	CROWN VICTORIA Base	
F	03-06	CROWN VICTORIA LX	
F	04-05	CROWN VICTORIA LX Sport	
F	05	CROWN VICTORIA S	
F	05	CROWN VICTORIA Special Edition	
F	03	CROWN VICTORIA LWB	
F	03	CROWN VICTORIA S	
F	03-11	LINCOLN TOWN CAR Executive	
F	03-11	MERCURY GRAND MARQUIS Todos	
143358	W		
F	04-10	INFINITI QX56 Todos	
F	05-11	NISSAN ARMADA Todos	
F	04-11	TITAN Todos	
143359	FF		
F	04-10	INFINITI QX56 Todos	
F	07-11	NISSAN ARMADA Todos	
F	04-11	TITAN Todos	
143360	W		
F	06-10	FORD EXPLORER Todos	
F	06-10	MERCURY MOUNTAINEER Todos	
143361	D		
R	06-10	FORD EXPLORER Todos	
R	06-10	MERCURY MOUNTAINEER Todos	
143362	FF		
R	06-10	FORD EXPLORER Todos	
R	06-10	MERCURY MOUNTAINEER Todos	
143363	W		
F	05-06	CHEVROLET EQUINOX Todos	
F	06	PONTIAC TORRENT Todos	
143364	W		
F	06-10	JEEP COMMANDER Todos	
F	05-10	GRAND CHEROKEE Todos	
143365	W		
F	10-12	MAZDA 3 Grand Touring	
F	10-12	3 GX	
F	10-12	3 I Touring	
F	08-12	3 GS	
F	08-12	3 GT	
F	04-12	3 i	
F	12	3 GS-SKY	
F	12	3 S	
F	08-09	3 S	
F	08	3 GX	
F	05	3 SP23	
F	06-10	5 Todos	
143366	FF		
F	08-12	BUICK ENCLAVE Todos	
F	09-12	CHEVROLET TRAVERSE Todos	
F	07-12	GMC ACADIA Todos	
F	07-10	SATURN OUTLOOK Todos	
143367	W		
F	96-05	TOYOTA RAV4 Todos	
143368	W		
F	02-07	SATURN VUE Todos Reemplaza el Montaje en el Kit de Servicio GM #15269823	
143369	D		
F	05-10	CHRYSLER 300 4x2 Tracción trasera	
F	08-10	DODGE CHALLENGER Todos	
F	06-10	CHARGER 4x2 Tracción trasera	
F	05-08	MAGNUM 4x2 Tracción trasera	
143375	FF		
R	06-11	CHEVROLET AVEO Todos	
R	04-11	AVEO Todos	
R	07-10	PONTIAC G3 Todos	
R	05-08	WAVE Todos	
R	04-09	SUZUKI SWIFT Todos	
143376	FF		
F	07-09	FORD EXPEDITION 4x2 Tracción trasera	
F	09	PICKUP 1/2 TON, F-150 4x2 Tracción trasera	

Bases de Struts

Amort.	POP	No. Alternativo	Montaje Accesorio
Pos.	Año	Aplicación	
143376	FF	-continued	
F	07-09	LINCOLN NAVIGATOR Todos	
143377	FF		
F	07-10	NISSAN SENTRA Todos Izquierdo	
143378	FF		
F	07-10	NISSAN SENTRA Todos Derecho	
143379	FF		
F	10-11	NISSAN EQUATOR	
F	05-12	FRONTIER Todos	
F	05-11	PATHFINDER Todos	
F	05-12	XTERRA Todos	
F	09-11	SUZUKI EQUATOR Todos	
143380	FF		
R	98-05	VOLKSWAGEN PASSAT 4x2 Tracción delantera	
143381	FF		
F	06-10	KIA MAGENTIS Todos Izquierdo	
F	06-10	OPTIMA Todos Izquierdo	
143382	FF		
F	06-10	KIA MAGENTIS Todos Derecho	
F	06-10	OPTIMA Todos Derecho	
143383	FF		
F	03-16	TOYOTA 4RUNNER Todos	
F	07-12	FJ CRUISER Todos	
F	05-12	TACOMA Todos	
143385	FF		
F	05-09	DODGE DAKOTA Todos	
F	06-09	MITSUBISHI RAIDER Todos	
143386	FF		
R	06-10	HYUNDAI AZERA Todos	
R	06-10	SONATA Todos	
R	07-11	KIA RONDO Todos	
143387	FF		
R	04-06	LEXUS RX330 Todos Izquierdo Exc. Suspensión de Aire	
R	07-09	RX350 Todos Izquierdo Exc. Suspensión de Aire	
R	06-08	RX400H Todos Izquierdo	
R	04-07	TOYOTA HIGHLANDER Todos Izquierdo	
143388	FF		
R	04-06	LEXUS RX330 Todos Derecho Exc. Suspensión de Aire	
R	07-09	RX350 Todos Derecho Exc. Suspensión de Aire	
R	06-08	RX400H Todos Derecho	
R	04-07	TOYOTA HIGHLANDER Todos Derecho	
143389	FF		
F	09-10	DODGE PICKUP 1/2 TON, RAM 1500 4x4	
F	07-12	FORD EXPEDITION 4x2 Tracción trasera	
F	11-12	RAM 1500 (SEE DODGE RAM 1500) 4x4	
143390	FF		
R	05-07	FORD FIVE HUNDRED 4x2 Tracción delantera Izquierdo	
R	05-07	MERCURY MONTEGO Todos Izquierdo	
143391	FF		
R	05-07	FORD FIVE HUNDRED 4x2 Tracción delantera Derecho	
R	05-07	MERCURY MONTEGO Todos Derecho	
143392	FF		
F	06-12	FORD FUSION Todos	
F	07-12	LINCOLN MKZ Todos	
F	06	ZEPHYR Todos	
F	05-08	MAZDA 6 Todos	
F	06-11	MERCURY MILAN Todos	
143393	FF		
R	15-16	FORD EXPEDITION 4x4 Exc. Suspensión de Aire	
R	15-16	EXPEDITION 4x2 Tracción trasera Exc. Suspensión de Aire	
R	10-14	EXPEDITION Todos Exc. Suspensión de Aire	
R	07-09	EXPEDITION 4x2 Tracción trasera	
R	10-16	LINCOLN NAVIGATOR 4x4 Exc. Suspensión de Aire	

Lista numérica

Amort.	POP	No. Alternativo	Montaje Accesorio
Pos.	Año	Aplicación	
143393	FF	-continued	
R	10-16	NAVIGATOR 4x2 Tracción trasera Exc. Suspensión de Aire	
R	07-09	NAVIGATOR 4x2 Tracción trasera	
143394	FF		
R	02-10	MITSUBISHI LANCER Todos	
R	03-11	OUTLANDER Todos	
143395	FF		
F	07-12	NISSAN ALTIMA Todos	
143396	FF		
R	03-07	NISSAN MURANO Todos	
R	04-09	QUEST Todos	
143397	FF		
F	03-08	HYUNDAI TIBURON Todos	
143398	FF		
F	04-11	MITSUBISHI ENDEAVOR Todos	
143399	FF		
F	11-12	FORD FIESTA Todos	
F	11	MAZDA 2 Todos	
143400	FF		
R	11-12	FORD FIESTA Todos	
R	11	MAZDA 2 Todos	
143401	FF		
F	02-07	SUZUKI AERIO Todos	
143402	FF		
F	07-11	LEXUS ES350 Todos	
F	07-11	ES350 Todos Mount Kit w/ Strut Mount, Bearing & 3 Nuts	
F	06-11	TOYOTA AVALON Todos	
F	06-11	AVALON Todos Mount Kit w/ Strut Mount, Bearing & 3 Nuts	
F	07-11	CAMRY Todos	
F	07-11	CAMRY Todos Mount Kit w/ Strut Mount, Bearing & 3 Nuts	
F	08-13	HIGHLANDER Todos	
F	08-10	HIGHLANDER Todos Mount Kit w/ Strut Mount, Bearing & 3 Nuts	
F	09-11	VENZA Todos Mount Kit w/ Strut Mount, Bearing & 3 Nuts	
143403	FF		
F	02-08	JAGUAR X-TYPE Todos Exc. Suspensión de Tecnología Computarizada Activa (CATS)	
143404	FF		
F	02-06	MINI COOPER Todos	
143405	FF		
R	02-11	MINI COOPER Todos	
143406	FF		
F	05-10	SCION TC Todos	
143407	FF		
F	08-09	FORD TAURUS Todos	
143408	FF		
R	98-05	LEXUS GS300 Todos	
R	98-00	GS400 Todos	
R	01-05	GS430 Todos	
R	01-05	IS300 Todos	
143409	FF		
F	06-11	HYUNDAI ACCENT Todos Izquierdo	
F	08-11	KIA RIO Todos Izquierdo	
F	06-11	RIO Todos Izquierdo	
143410	FF		
F	06-11	HYUNDAI ACCENT Todos Derecho	
F	06-11	KIA RIO Todos Derecho	
F	06-11	RIO Todos Derecho	
143411	FF		
R	06-11	HYUNDAI ACCENT Todos	
R	06-11	KIA RIO Todos	
R	06-11	RIO Todos	
143412	FF		
F	06-08	MAZDA MX-5 MIATA Todos	
R	06-08	MX-5 MIATA Todos	
143413	FF		
R	06-11	TOYOTA AVALON Todos Izquierdo	
R	07-11	CAMRY Todos Izquierdo	
143414	FF		
R	06-11	TOYOTA AVALON Todos Derecho	
R	07-11	CAMRY Todos Derecho	

Lista numérica

Amort.	POP	No. Alternativo	Montaje Accesorio
Pos.	Año	Aplicación	
143415	FF		
F	07-10	FORD EDGE Todos	
F	08-09	TAURUS X Todos	
F	07-09	LINCOLN MKX Todos	
F	08-09	MERCURY SABLE Todos	
143416	FF		
F	07-09	HYUNDAI ENTOURAGE Todos	
F	07-11	SANTA FE Todos	
F	07-11	VERACRUZ Todos	
F	06-11	KIA SEDONA Todos	
143417	FF		
F	08-11	SCION XD Todos	
F	06-13	TOYOTA YARIS Todos	
143418	FF		
R	02-07	SUZUKI AERIO Todos	
143419	FF		
F	04-06	KIA AMANTI Todos	
R	04-06	AMANTI Todos	
143421	FF		
F	00-04	VOLVO S40 Todos	
F	00-04	V40 Todos	
143422	FF		
R	00-04	VOLVO S40 Todos	
R	00-04	V40 Todos	
143423	C		
F	03-06	CHRYSLER SEBRING JR (Código plataforma del fabricante), Convertible	
F	03-06	SEBRING JR (Código plataforma del fabricante), Sedan	
R	01-06	SEBRING JR (Código plataforma del fabricante), Convertible	
R	01-06	SEBRING JR (Código plataforma del fabricante), Sedan	
R	01-06	DODGE STRATUS Sedan	
R	99-00	STRATUS Todos	
143424	FF		
F	15-16	FORD EXPEDITION 4x4	
F	15-16	EXPEDITION 4x2 Tracción trasera	
F	10-14	EXPEDITION Todos	
F	07-09	EXPEDITION 4x2 Tracción trasera	
F	10-12	PICKUP 1/2 TON, F-150 Todos	
F	11-16	LINCOLN NAVIGATOR 4x4	
F	11-16	NAVIGATOR 4x2 Tracción trasera	
F	07-10	NAVIGATOR Todos	
143425	FF		
R	08	CHEVROLET MALIBU Base	
R	08	MALIBU Hybrid	
R	08	MALIBU LS	
R	08	MALIBU LT	
R	08	MALIBU LTZ	
R	04-07	MALIBU Maxx LS	
R	04-07	MALIBU Maxx LT	
R	04	MALIBU Maxx	
R	05-10	PONTIAC G6 Todos	
R	07-09	SATURN AURA XE	
R	07-09	AURA XR	
R	07-08	AURA Green Line	
143455	FF		
F	03-07	INFINITI G35 Todos	
F	06-07	M35 Todos	
F	03-08	NISSAN 350Z Todos	
143456	FF		
F	04-05	KIA RIO Sedan Izquierdo	
143457	FF		
F	04-05	KIA RIO Sedan Derecho	
143458	FF		
F	02-05	KIA SEDONA Todos	
143459	FF		
F	04-06	PONTIAC GTO Todos	
143460	FF		
F	10-12	CHEVROLET CAMARO 3.6L 6Cyl V (217)	
143461	FF		
R	10-12	CHEVROLET CAMARO 3.6L 6Cyl V (217) Izquierdo	
143462	FF		
R	10-12	CHEVROLET CAMARO 3.6L 6Cyl V (217) Derecho	

Bases de Struts, Protectores de Struts

Amort.	POP	No. Alternativo	Montaje Accesorio
Pos.	Año	Aplicación	
143463	FF		
F	08-16	CHRYSLER TOWN & COUNTRY Todos	
F	08-16	DODGE CARAVAN / GRAND CARAVAN Todos	
F	09-11	VOLKSWAGEN ROUTAN Todos	
143464	FF		
F	01-03	MITSUBISHI MONTERO Todos	
143465	FF		
R	02-03	SUBARU IMPREZA Todos Izquierdo	
143466	FF		
R	02-03	SUBARU IMPREZA Todos Derecho	
143468	FF		
F	11-13	CHRYSLER 300 Todos	
F	11-13	DODGE CHARGER AWD	
143469	FF		
F	07-11	CHEVROLET EQUINOX Todos	
F	10-11	GMC TERRAIN Todos	
F	07-09	PONTIAC TORRENT Todos	
F	08-10	SATURN VUE Todos	
F	07-09	SUZUKI XL-7 Todos	
143473	FF		
F	10-15	CHEVROLET CRUZE Todos	
F	11-13	CRUZE Todos Strut Mount	
F	16	CRUZE LIMITED Todos	
143474	FF		
R	10-15	CHEVROLET CRUZE Todos	
R	11-13	CRUZE Todos Strut Mount	
R	16	CRUZE LIMITED Todos	
143475	FF		
F	11-14	FORD EXPLORER Todos	
143476	FF		
R	11-14	FORD EXPLORER Todos	
R	10-14	TAURUS Todos	
143477	FF		
F	07-11	HYUNDAI ELANTRA Todos	
143486	FF		
F	13-14	CHEVROLET TRAVERSE Todos	
143491	FF		
F	07-12	MINI COOPER Todos	
143492	FF		
F	98-13	SUBARU FORESTER Todos	
F	93-13	IMPREZA Todos	
F	90-13	LEGACY Todos	
F	00-13	OUTBACK Todos	
143495	FF		
F	07-11	DODGE CALIBER Todos	
F	07-10	JEEP COMPASS Todos	
F	07-10	PATRIOT Todos	
143496	FF		
R	07-11	DODGE CALIBER Todos	
R	07-10	JEEP COMPASS Todos	
R	07-10	PATRIOT Todos	
143497	FF		
F	06-11	HONDA CIVIC Todos	
143498	FF		
R	06-11	HONDA CIVIC Todos	
143509	FF		
R	11-13	TOYOTA HIGHLANDER Todos Izquierdo	
143510	FF		
R	11-13	TOYOTA HIGHLANDER Todos Derecho	
143516	FF		
F	09-12	NISSAN CUBE Todos Izquierdo	
F	07-11	TIIDA Todos Izquierdo	
F	07-11	VERSA S Izquierdo	
F	07-11	VERSA SL Izquierdo	
143517	FF		
F	09-12	NISSAN CUBE Todos Derecho	
F	07-11	VERSA S Derecho	
F	07-11	VERSA SL Derecho	
143522	FF		
F	11-13	NISSAN FRONTIER S Fab. hasta 12/12	
F	11-13	FRONTIER SL Fab. hasta 12/12	

Lista numérica

Amort.	POP	No. Alternativo	Montaje Accesorio
Pos.	Año	Aplicación	
143522	FF		-continued
F	09-13	FRONTIER PRO-4X Fab. hasta 12/12	
F	05-13	FRONTIER LE Fab. hasta 12/12	
F	05-10	FRONTIER SE Fab. hasta 12/12	
143528	FF		
F	12-15	HONDA CIVIC Todos	
143530	FF		
R	12-13	HONDA CIVIC Todos	
143531	FF		
R	04-11	MAZDA 3 Todos	
R	06-10	5 Todos	
143532	FF		
F	11-14	HYUNDAI SONATA Todos	
143533	FF		
R	11-14	HYUNDAI SONATA Todos	
143552	FF		
F	06-08	VOLKSWAGEN BORA Todos	
F	06-08	JETTA Todos	
143553	FF		
F	10-12	TOYOTA PRIUS Todos	
143554	FF		
R	10-12	TOYOTA PRIUS Todos	
143564	FF		
F	10-13	FORD TRANSIT CONNECT Todos	
Protectores de Struts			
143057	D		
R	02-05	FORD SABLE	
R	94	SABLE	
R	95-01	SABLE Todos	
143058	W		
F	87-98	VOLKSWAGEN GTI	
143059	D		
F	73-79	AUDI FOX Todos	
F	02-05	FORD SABLE	
F	96-01	SABLE Todos	
143060	W		
F	90	PLYMOUTH COLT DL, Wagon	
143063	W		
R	87-98	VOLKSWAGEN GTI	



Referencia A

(Kits de Manguera de Aire Ajustable)
(Procedimiento para Desactivar el Compresor Electrónico del Sistema de Autonivelación para modelos GM)

Referencia B

(Montajes de Strut)

Referencia C

(Botas para Estabilizadores de Dirección)

Referencia D

(Conversión de Suspensión Electrónica Ajustable)

Referencia E

(Combinaciones Izquierdo/Derecho)

Referencia F

(Explicación de Especificaciones)
(Especificaciones por Número de Parte)

Referencia G

(Disposición de Amortiguadores)

Referencia H

(Número de Fabricación vs. Número de Catálogo)

Referencia I

(Intercambio entre líneas GRC)

Referencia J

(Intercambio vs. Competidores)



KITS DE MANGUERA DE AIRE AJUSTABLE

El kit de manguera **141099** viene con todos los Amortiguadores de Aire Ajustables en este catálogo. Para los autos equipados con Sistema de Auto Nivelación General Motors, puede ser necesario comprar el kit con adaptador **141248**. El kit de manguera **140656** con válvulas separadas puede ser instalado en el auto para permitir que los Amortiguadores de Aire Ajustables sean cargados individualmente.

KITS PARA REEMPLAZAR EQUIPOS DE AIRE

Cada kit está empacado en bolsas de plástico

NÚMERO DE PARTE	CONTENIDO	
140701 Válvula de aire para reemplazo.	1 Válvula superior 1 Tapa 1 Arandela de metal	1 Arandela de caucho 2 Tuercas 1 Anillo de alerta de presión de aire
140721 Herramienta necesaria para una instalación completa; excluyendo el ensamble de la manguera.	1 Válvula de latón 1 Tapa 1 Arandela de metal	1 Arandela de goma 1 Tuerca 1 Anillo de alerta de presión de aire
141122 Reemplazo de manguera y equipos.	2 Tuercas de tubo 2 Ganchos de tubo 6 'O' rings	1 Tubo 3 Abrazaderas para tubo

SISTEMA DE AUTONIVELACIÓN GENERAL MOTORS /CRUCE DE REFERENCIA DE KIT DE MANGUERA

Los autos de General Motors equipados con Sistemas de Autonivelación GM de fábrica requieren un adaptador de manguera para operar con nuestros Amortiguadores de Aire Ajustables. Encuentre la aplicación correcta para su auto en la tabla siguiente.

El uso de amortiguadores convencionales en estas aplicaciones requeriría la desactivación del compresor del aire.

APLICACIÓN	NO. DE PARTE HIJACKERS	KIT(S) DE MANGUERA REQUERIDO(S)
1979-85 Buick Riviera	49345	141099 o 141248*
1979-85 Cadillac Eldorado	49345	141099 o 141248*
1980-85 Cadillac Seville	49345	141099 o 141248*
1979-85 Oldsmobile Toronado	49345	141099 o 141248*
Los autos G.M. con sistema de auto-nivelación operados electrónicamente o los operados con sistema de auto nivelación al vacío (excepto los de la lista de arriba)	Información viene en el manual	141099 y 141248**

* 141099 y 141248 empacados con los amortiguadores de Aire Ajustables. En lista como referencia, si es necesario reemplazarlos.

** 141099 empacado con los amortiguadores de Aire Ajustables. El 141248 debe comprarse por separado y usarse con el kit de manguera empacado con los amortiguadores.

Kit No. 141099 contiene:

- 4 - Tuercas de tubo
- 4 - Ganchos de tubo
- 10 - 'O' rings
- 1 - Tubo
- 1 - Equipo de válvula de aire de bloqueo superior
- 1 - Válvula central
- 6 - Abrazaderas para tubo
- 1 - Tapa de válvula
- 1 - Arandela
- 2 - Tuercas hexagonales
- 1 - Sello
- 1 - Etiqueta de advertencia
- 1 - Hoja de instrucciones

Kit No. 141248*** contiene:

- 3 - Tuercas de tubo
- 3 - Ganchos de tubo
- 8 - 'O' rings
- 2 - Abrazaderas para tubo
- 1 - Válvula con adaptador de tubo & subensamble de sello
- 1 - Válvula con adaptador de tubo
- 1 - Tornillo autoroscante
- 1 - Cople (latón)
- 1 - Resorte de compresión
- 1 - Válvula central
- 1 - Abrazadera superior
- 1 - Tapa de válvula
- 1 - Hoja de instrucciones

*** Use junto con el kit de manguera # 141099.

PROCEDIMIENTO PARA DESACTIVAR EL COMPRESOR ELECTRÓNICO DEL SISTEMA DE AUTONIVELACIÓN PARA MODELOS GM

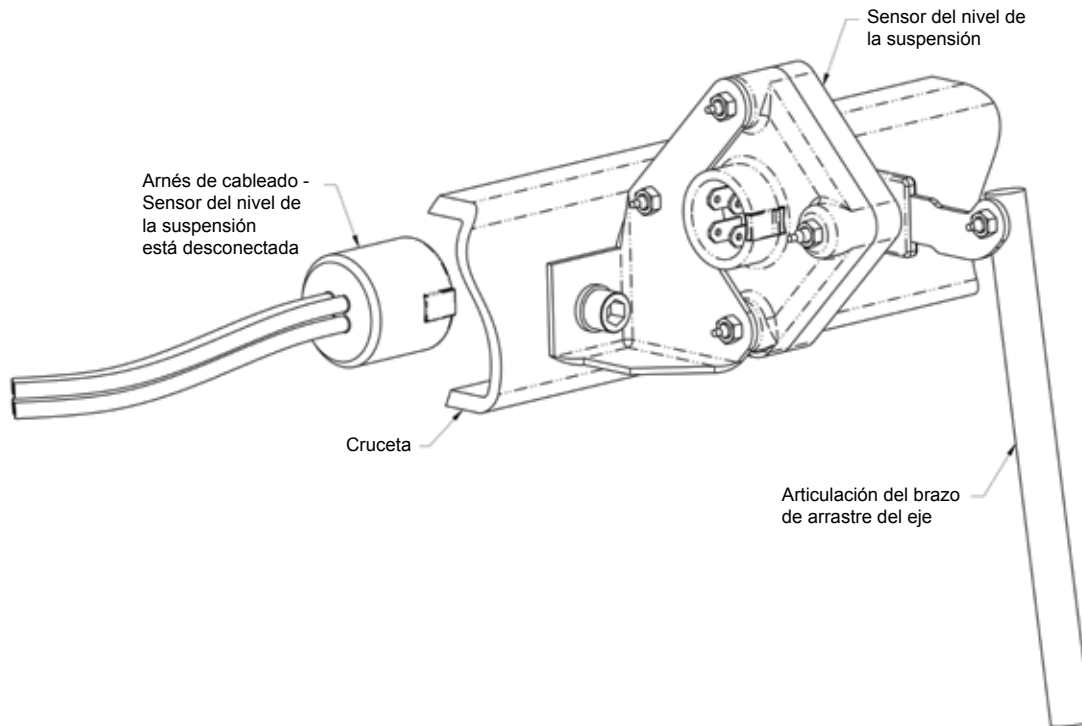

Cuando instale struts/amortiguadores convencionales en los modelos GM equipados con autonivelación en la suspensión trasera, que usa un compresor electrónico se debe hacer lo siguiente:

1. Ubique el sensor de nivel debajo de la carrocería del auto, aproximadamente encima del eje trasero de la suspensión independiente. Ubique una pequeña conexión pegada al brazo de control de la suspensión independiente / eje trasero. La parte superior de esta conexión estará conectada al sensor de nivel electrónico.
2. Desconecte los cables eléctricos del control del sensor. El sistema está ahora desactivado.
3. Cubra el conector que está expuesto con cinta u otro material apropiado, y asegúrelo por debajo del auto.
4. NO es necesario desconectar la conexión del brazo de control de la suspensión/eje trasero.

¿QUÉ ES LA BASE DE UN STRUT?

La Base de un Strut es la parte que une el strut a la carrocería del auto. Consiste por lo general de placas de acero separadas una de la otra por un polímero de caucho. El strut está conectado a una de las placas de acero. El rodamiento es utilizado por los sistemas de suspensión que el strut usa para voltear, proveyendo un movimiento suave. La Base de un Strut juega un papel VITAL en el manejo del auto, el control del viaje, la alineación, frenos y la dirección. Cuando las Bases de un Strut están gastadas o dañadas, el manejo original del auto se verá negativamente afectado.

¿CÓMO FUNCIONA LA BASE DE UN STRUT?

Provee una conexión entre el strut y la carrocería.

Actúa como un “amortiguador” encima y detrás de la operación del strut, para eliminar aun más la no deseada vibración al viajar.

Es una parte del alineamiento que puede ser usado para ajustar ambos, la rodachina y la inclinación de las ruedas delanteras del volante.

Actúa como un eje para el mecanismo de la dirección, proveyendo una navegación suave por la reacción en la montura.

Ayuda a mantener el auto en una dirección recta y nivelada, aun cuando se frene fuertemente.

Ayuda a eliminar el tambaleo de la carrocería en las curvas.

¿CÓMO SABER CUÁNDO REEMPLAZAR LA BASE DE UN STRUT?

El reemplazo depende del tipo de viaje, la manera del manejo y el auto. Una buena guía para saber es que, si los struts están desgastados, las bases también lo están. Una base desgastada tendrá una o más de las siguientes características:

Golpeteo cuando se maneja bajo condiciones normales

Dureza en el volante – endurecimiento (rodamiento desgastado)

Navegación pobre

Resbala o tambalea en las curvas

Auto rebota o se resbala hacia los lados en una carretera con fuertes curvas (zigzagueante)

Inclinación anormal trasera cuando se acelera

Inclinación delantera anormal cuando se frena

Mala alineación – la parte superior está gastada al punto de que el auto no puede ser alineado a la especificación del Equipo Original

ÍNDICE VISUAL DE UNA BASE DE STRUT DESGASTADA:

- Fracturada y/o goma floja
- Oxidada
- Deformada o partes dobladas
- Pérdida de grasa por parte de los sellos de ensamble
- Señales de desgaste debido a la fricción

¿QUÉ PASA CUANDO LAS BASES DE STRUT ESTÁN GASTADAS?

El desgaste de las bases pueden disminuir la duración de:

- Junta del ensamble
- Ensamblados del CV
- Resortes
- Struts
- Conexión de la dirección
- Llantas































CÓMO VENDER UNA BASE DE STRUT DE REPUESTO:

- Eduque al cliente acerca de las bases y cómo se desgastan.
- Explique la importancia de la base de strut al cliente.
- Explique al cliente cómo el reemplazo de la base de strut le devolverá al auto las especificaciones apropiadas del Equipo Original.
- Con la nueva base de strut instalada, el auto del cliente será más seguro y más fácil de manejar.































¿POR QUÉ EL PROGRAMA DE BASES DE STRUT GRC ES EL MEJOR DEL MERCADO ACTUALMENTE?

- El mejor tratamiento para su auto.
- La más alta calidad en las piezas en el mercado.
- Todas las bases de struts cumplen o exceden los requerimientos del Equipo Original.
 - *Solo partes que cumplen con el Equipo Original son usados.*
 - *La unión de caucho con acero es superior.*
 - *Excelente resistencia y durabilidad.*
 - *Accesorios de instalación incluidos (solo si aplica).*
 - *Instrucciones específicas para instalación incluidas con cada producto.*































BASES DE STRUTS

 141578	 141580	 141974	 142091	 142092
 142103	 142108	 142132	 142133	 142134
 142135	 142136	 142141	 142142	 142143
 142144	 142145	 142146	 142148	 142150
 142173	 142183	 142189	 142190	 142194
 142195	 142196	 142197	 142217	 142219































BASES DE STRUTS

 142220	 142221	 142222	 142223	 142224
 142225	 142226	 142227	 142228	 142229
 142230	 142231	 142233	 142234	 142237
 142240	 142241	 142242	 142244	 142245
 142247	 142248	 142249	 142250	 142251
 142252	 142254	 142292	 142293	 142294



























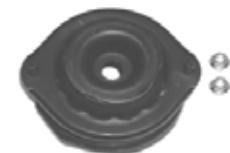
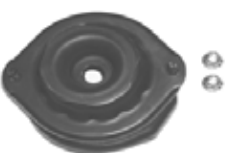

BASES DE STRUTS

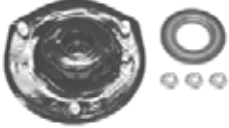
 142295	 142296	 142297	 142298	 142300
 142301	 142302	 142306	 142307	 142311
 142316	 142317	 142321	 142325	 142326
 142329	 142330	 142334	 142335	 142393
 142396	 142399	 142402	 142403	 142404
 142405	 142406	 142408	 142409	 142411































BASES DE STRUTS

 142412	 142413	 142415	 142419	 142426
 142427	 142428	 142429	 142430	 142436
 142437	 142439	 142440	 142442	 142444
 142521	 142524	 142525	 142526	 142527
 142529	 142530	 142531	 142532	 142535
 142536	 142543	 142546	 142547	 142550































BASES DE STRUTS

 142556	 142559	 142561	 142562	 142567
 142568	 142569	 142570	 142571	 142572
 142573	 142623	 142625	 142626	 142639
 142640	 142641	 142642	 142643	 142646
 142647	 142648	 142649	 142650	 142651
 142652	 142653	 142654	 142734	 142735































BASES DE STRUTS

 142738	 142741	 142744	 142745	 142746
 142747	 142748	 142749	 142750	 142751
 142752	 142753	 142754	 142755	 142757
 142762	 142763	 142803	 142825	 142826
 142827	 142828	 142832	 142834	 142836
 142837	 142838	 142840	 142841	 142842

BASES DE STRUTS

 142843	 142844	 142845	 142846	 142847
 142850	 142851	 142852	 142853	 142854
 142855	 142856	 142857	 142858	 142859
 142860	 142861	 142862	 142880	 142930
 142931	 142932	 142933	 142935	 142936
 142937	 142938	 142939	 142940	 142941































BASES DE STRUTS

 <p>142942</p>	 <p>142943</p>	 <p>142949</p>	 <p>142992</p>	 <p>143030</p>
 <p>143035</p>	 <p>143036</p>	 <p>143037</p>	 <p>143067</p>	 <p>143071</p>
 <p>143072</p>	 <p>143073</p>	 <p>143074</p>	 <p>143082</p>	 <p>143083</p>
 <p>143084</p>	 <p>143086</p>	 <p>143087</p>	 <p>143088</p>	 <p>143089</p>
 <p>143090</p>	 <p>143091</p>	 <p>143092</p>	 <p>143093</p>	 <p>143094</p>
 <p>143112</p>	 <p>143113</p>	 <p>143116</p>	 <p>143139</p>	 <p>143140</p>































BASES DE STRUTS

 143191	 143193	 143194	 143195	 143196
 143197	 143198	 143199	 143200	 143201
 143202	 143204	 143205	 143206	 143207
 143208	 143209	 143210	 143214	 143218
 143219	 143220	 143221	 143222	 143223
 143224	 143226	 143227	 143228	 143231























BASES DE STRUTS

 <p>143233</p>	 <p>143235</p>	 <p>143236</p>	 <p>143239</p>	 <p>143240</p>
 <p>143241</p>	 <p>143242</p>	 <p>143244</p>	 <p>143246</p>	 <p>143248</p>
 <p>143253</p>	 <p>143255</p>	 <p>143256</p>	 <p>143259</p>	 <p>143262</p>
 <p>143263</p>	 <p>143264</p>	 <p>143265</p>	 <p>143266</p>	 <p>143267</p>
 <p>143277</p>	 <p>143278</p>	 <p>143279</p>	 <p>143280</p>	 <p>143281</p>
 <p>143305</p>	 <p>143315</p>	 <p>143316</p>	 <p>143317</p>	 <p>143318</p>

BASES DE STRUTS

 143319	 143320	 143321	 143322	 143323
 143324	 143325	 143328	 143330	 143335
 143336	 143337	 143338	 143339	 143340
 143341	 143342	 143344	 143353	 143354
 143355	 143356	 143357	 143358	 143359
 143360	 143361	 143362	 143363	 143364

BASES DE STRUTS

 <p>143365</p>	 <p>143367</p>	 <p>143368</p>	 <p>143369</p>	 <p>143375</p>
 <p>143377</p>	 <p>143378</p>	 <p>143381</p>	 <p>143382</p>	 <p>143383</p>
 <p>143389</p>	 <p>143390</p>	 <p>143391</p>	 <p>143392</p>	 <p>143396</p>
 <p>143397</p>	 <p>143404</p>	 <p>143406</p>	 <p>143408</p>	 <p>143419</p>
 <p>143422</p>	 <p>143423</p>	 <p>143425</p>		

BOTAS PARA ESTABILIZADORES DE DIRECCIÓN

COLOR	BOTAS	NÚMERO DE PARTE
ROJO		142001
NEGRO		142005
AZUL OSCURO		142008

Para las siguientes aplicaciones, si el ensamble de la varilla es el Diagrama 1 – “Y” Invertida – debe cambiarse al diagrama 2 de los modelos 1978-79 “T” Invertida (vea las ilustraciones abajo). En algunos Ford, la “T” Invertida no puede ser instalada ni tampoco estabilizadores duales.

1978-79 Ford Bronco (Sin barra de Control)
 1970-79 Ford 4 W.D. F-100, F-150 (Sin barra de Control)

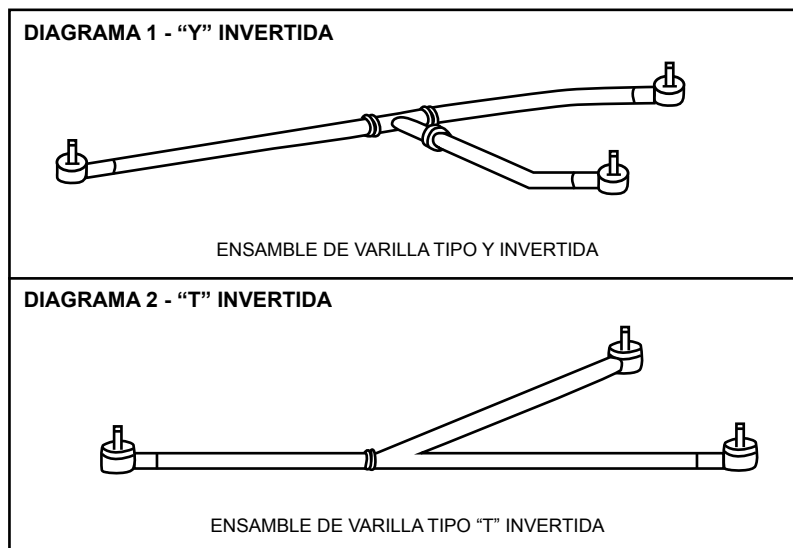

Los furgones (o trocas) con power steering no pueden ser convertidos a “T” Invertida.

CONVERSIÓN DE LA SUSPENSIÓN ELECTRÓNICA AJUSTABLE

A algunos autos equipados con Suspensión Electrónica Ajustable se les puede reemplazar con un strut/ amortiguador que no sea ajustable. La siguiente es una lista de esos autos y el proceso para reemplazarlos.

BUICK PARK AVENUE 1993-96 con CCR (Viaje Dirigido por Computadora)

Remueva los actuadores del strut.

Remueva el CCR. Está debajo del asiento del chofer.

- o Referencia GM Documento VSS20000025

Remueva los struts e instale G56718 delantero y uno de los siguientes traseros:

- o G56707, G56726, G56903, G56906

BUICK SKYLARK 1992-94 con CCR (Viaje Dirigido por Computadora)

Remueva los actuadores del amortiguador y del strut

Remueva el CCR. Está detrás del compartimiento del aislador de sonido, al lado derecho.

- o Referencia GM Documento VSS20000025

Remueva los amortiguadores y los struts e instale G56719, G56720 delantero y el 69749 trasero.

CADILLAC DEVILLE 1991-93 con CCR (Viaje Dirigido por Computadora)

Remueva los actuadores del strut

- o Referencia GM Documento VSS20000025 y el Manual de Servicio de GM para el ajuste del sistema.

Remueva los struts e instale G56718 delantero y uno de los siguientes traseros:

- o G56707, G56726, G56903, G56906

CADILLAC ELDORADO 1991-92 con CCR (Viaje Dirigido por Computadora)

o SSS (Suspensión con Velocidad Sensitiva)

Remueva los actuadores del strut

Referencia GM Documento VSS20000025 y el Manual de Servicio de GM para el ajuste del sistema.

Remueva los struts e instale G56717 delantero y el G56704 trasero.

CADILLAC SEVILLE 1991-92 con CCR (Viaje Dirigido por Computadora)

o SSS (Suspensión con Velocidad Sensitiva)

Remueva los actuadores del strut

- o Referencia GM Documento VSS20000025 y el Manual de Servicio para el ajuste del sistema.

Remueva los struts e instale G56717 delantero y el G56704 trasero.

CHEVROLET CORVETTE 1990-96 con ERC (Control Electrónico)

Remueva los actuadores de los amortiguadores.

Desconecte al módulo ERC. Está en la cajuela.

Remueva los amortiguadores e instale 69811 o 75811 delantero y el 69795 o el 75795 trasero.

FORD PROBE 1989-92 con PRC (Control Programado)

Remueva los actuadores del strut.

Desconecte el módulo PRC. Está debajo del asiento del chofer.

Remueva los struts e instale G55600 delantero y el G55601 trasero.

FORD THUNDERBIRD TURBO COUPE 1987-88 con PRC (Control Programado)

Remueva los actuadores del amortiguador.

Desconecte del módulo PRC. Está en la cajuela.

Remueva los struts y los amortiguadores e instale G56504 delantero y el 69709 trasero.

MAZDA MX6 GT 1988-92 con AAS (Suspensión Ajustable Automática)

Remueva los actuadores del strut.

Desconecte el módulo AAS. Está en la cajuela.

Remueva los struts e instale G55600 delantero y el G55601 trasero.

MAZDA RX7 TURBO 1989-90 y MAZDA RX7 GXL 1986-88 con AAS (Suspensión Ajustable Automática)

Remueva los actuadores del strut y de los amortiguadores.

Desconecte el módulo AAS. Está en la cajuela.

Remueva los struts e instale G55542 delantero y el G51031 trasero.

CONVERSIÓN DE LA SUSPENSIÓN ELECTRÓNICA AJUSTABLE

MAZDA 626 1988-92 con AAS (Suspensión Ajustable Automática)

Remueva los actuadores del strut
 Desconecte el módulo AAS. Está en la cajuela.
 Remueva los struts e instale G55600 delantero y el G55601 trasero.

MAZDA 929 1988-89 con AAS (Suspensión Ajustable Automática)

Remueva los actuadores del strut y de los amortiguadores.
 Desconecte el módulo AAS. Está en la cajuela.
 Remueva los struts e instale G55713 delantero y el G51192 trasero.

MAZDA 929 1990-91 con AAS (Suspensión Ajustable Automática)

Remueva los actuadores del strut y de los amortiguadores
 Desconecte el módulo AAS. Está en la cajuela.
 Remueva los struts e instale G55716 delanteros y el G51192 trasero.

MERCURY COUGAR XR7 1987-88 con PRC (Control Programado)

Remueva los actuadores del strut y de los amortiguadores.
 Desconecte el módulo AAS. Está en la cajuela.
 Remueva los struts y amortiguadores e instale G56504 delantero y el 69709.

MITSUBISHI MONTERO 1992-96 con VSA (Amortiguadores Variables)

Remueva los actuadores del amortiguador.
 Desconecte al módulo VSA. Está detrás del compartimiento izquierdo.
 Remueva los amortiguadores e instale G63782 o 77782 delanteros y el G63781 o 77781 traseros.

NISSAN MAXIMA 1989-94 con NSS (Suspensión Sonar de Nissan) II

Remueva los actuadores del strut.
 Desconecte al módulo NSS. Está en la consola.
 Remueva los struts e instale G55607, G55608 delantero y el G44990 trasero.

NISSAN PATHFINDER 1987-95 con ASA (Amortiguadores Ajustables)

Remueva los actuadores del amortiguador.
 Desconecte el botón de control. Está en la consola.
 Remueva los amortiguadores e instale G63904 o 77904 delanteros y el G63492 o 77492 traseros.

OLDSMOBILE ACHIEVA 1992-94 con CCR (Viaje Dirigido por Computador)

Remueva los actuadores de los amortiguadores y el strut.
 Remueva el CCR. Está detrás del compartimiento del aislador de sonido, al lado derecho.
 o (Referencia GM Documento VSS20000025)
 Remueva los amortiguadores y los struts e instale G56719, G56720 delantero y el 69749 trasero.

OLDSMOBILE NINETY EIGHT 1991-96 con CCR (Viaje Dirigido por Computador)

Remueva los actuadores del strut.
 Remueva el CCR. Está debajo del asiento del chofer.
 Remueva los struts e instale G56718 delantero y uno de los siguientes traseros:
 G56707, G56726, G56903, G56906

PONTIAC BONNEVILLE 1994-99 con CCR (Viaje Dirigido por Computador)

Remueva los actuadores del strut.
 Remueva el CCR. Está debajo del asiento del chofer.
 Remueva los struts e instale G56718 delantero y uno de los siguientes traseros:
 G56707, G56726, G56903, G56906

TOYOTA SUPRA de MARZO 1986-95 con TEMS (Sistema Modulado Electronico Toyota)

Remueva los actuadores del amortiguador.
 Desconecte el módulo TEMS. Está debajo del tablero.
 Remueva los amortiguadores e instale G51197 delantero y el G51193 trasero.

COMBINACIONES IZQUIERDO / DERECHO

Struts Ultra				Struts Ultra (Continuado)				Struts Ultra (Continuado)			
G52000	DEL IZQ	G52001	DEL DER	G52110	DEL IZQ	G52111	DEL DER	G52237	DEL IZQ	G52238	DEL DER
G52002	TRAS IZQ	G52003	TRAS DER	G52112	DEL IZQ	G52113	DEL DER	G52245	DEL IZQ	G52246	DEL DER
G52004	DEL IZQ	G52007	DEL DER	G52117	DEL IZQ	G52118	DEL DER	G52247	DEL IZQ	G52248	DEL DER
G52005	DEL IZQ	G52006	DEL DER	G52121	DEL IZQ	G52122	DEL DER	G52249	DEL IZQ	G52250	DEL DER
G52008	DEL IZQ	G52009	DEL DER	G52123	DEL IZQ	G52124	DEL DER	G52253	DEL IZQ	G52254	DEL DER
G52013	DEL IZQ	G52014	DEL DER	G52127	DEL IZQ	G52128	DEL DER	G52255	DEL IZQ	G52256	DEL DER
G52015	DEL IZQ	G52016	DEL DER	G52129	DEL IZQ	G52130	DEL DER	G52257	DEL IZQ	G52258	DEL DER
G52017	TRAS IZQ	G52018	TRAS DER	G52136	DEL IZQ	G52137	DEL DER	G52260	DEL IZQ	G52261	DEL DER
G52019	DEL IZQ	G52020	DEL DER	G52138	DEL IZQ	G52139	DEL DER	G52262	DEL IZQ	G52263	DEL DER
G52021	TRAS IZQ	G52022	TRAS DER	G52140	DEL IZQ	G52141	DEL DER	G52264	DEL IZQ	G52265	DEL DER
G52023	DEL IZQ	G52024	DEL DER	G52142	DEL IZQ	G52143	DEL DER	G52268	DEL IZQ	G52269	DEL DER
G52026	DEL IZQ	G52027	DEL DER	G52144	DEL IZQ	G52145	DEL DER	G52270	DEL IZQ	G52271	DEL DER
G52028	DEL IZQ	G52029	DEL DER	G52148	DEL IZQ	G52149	DEL DER	G52272	DEL IZQ	G52273	DEL DER
G52030	DEL IZQ	G52031	DEL DER	G52150	DEL IZQ	G52151	DEL DER	G52274	DEL IZQ	G52275	DEL DER
G52032	DEL IZQ	G52033	DEL DER	G52152	DEL IZQ	G52153	DEL DER	G52278	DEL IZQ	G52279	DEL DER
G52034	DEL IZQ	G52035	DEL DER	G52154	DEL IZQ	G52155	DEL DER	G52280	DEL IZQ	G52281	DEL DER
G52036	DEL IZQ	G52037	DEL DER	G52156	DEL IZQ	G52157	DEL DER	G52282	DEL IZQ	G52283	DEL DER
G52038	DEL IZQ	G52039	DEL DER	G52158	DEL IZQ	G52159	DEL DER	G52297	DEL IZQ	G52298	DEL DER
G52044	DEL IZQ	G52045	DEL DER	G52160	DEL IZQ	G52161	DEL DER	G52299	DEL IZQ	G52300	DEL DER
G52046	DEL IZQ	G52047	DEL DER	G52162	TRAS IZQ	G52163	TRAS DER	G52312	DEL IZQ	G52313	DEL DER
G52053	DEL IZQ	G52052	DEL DER	G52164	DEL IZQ	G52165	DEL DER	G52327	DEL IZQ	G52328	DEL DER
G52055	DEL IZQ	G52056	DEL DER	G52166	DEL IZQ	G52167	DEL DER	G52331	DEL IZQ	G52332	DEL DER
G52057	DEL IZQ	G52058	DEL DER	G52168	DEL IZQ	G52169	DEL DER	G52333	TRAS IZQ	G52334	TRAS DER
G52061	DEL IZQ	G52062	DEL DER	G52170	DEL IZQ	G52171	DEL DER	G52335	TRAS IZQ	G52336	TRAS DER
G52063	DEL IZQ	G52064	DEL DER	G52173	DEL IZQ	G52174	DEL DER	G52339	DEL IZQ	G52340	DEL DER
G52067	DEL IZQ	G52068	DEL DER	G52175	DEL IZQ	G52176	DEL DER	G52344	DEL IZQ	G52345	DEL DER
G52069	DEL IZQ	G52070	DEL DER	G52178	TRAS IZQ	G52179	TRAS DER	G52346	DEL IZQ	G52347	DEL DER
G52071	TRAS IZQ	G52072	TRAS DER	G52180	DEL IZQ	G52181	DEL DER	G52348	DEL IZQ	G52349	DEL DER
G52073	TRAS IZQ	G52074	TRAS DER	G52182	TRAS IZQ	G52183	TRAS DER	G52360	DEL IZQ	G52361	DEL DER
G52075	DEL IZQ	G52076	DEL DER	G52184	DEL IZQ	G52185	DEL DER	G52433	DEL IZQ	G52432	DEL DER
G52077	DEL IZQ	G52078	DEL DER	G52187	DEL IZQ	G52188	DEL DER	G52453	DEL IZQ	G52454	DEL DER
G52079	DEL IZQ	G52080	DEL DER	G52193	DEL IZQ	G52194	DEL DER	G52494	DEL IZQ	G52495	DEL DER
G52081	DEL IZQ	G52082	DEL DER	G52199	DEL IZQ	G52200	DEL DER	G55607	DEL IZQ	G55608	DEL DER
G52083	DEL IZQ	G52084	DEL DER	G52201	DEL IZQ	G52202	DEL DER	G55610	DEL IZQ	G55611	DEL DER
G52085	TRAS IZQ	G52086	TRAS DER	G52203	TRAS IZQ	G52204	TRAS DER	G55652	DEL IZQ	G55653	DEL DER
G52087	DEL IZQ	G52088	DEL DER	G52209	DEL IZQ	G52210	DEL DER	G55657	DEL IZQ	G55658	DEL DER
G52089	TRAS IZQ	G52090	TRAS DER	G52214	DEL IZQ	G52215	DEL DER	G55661	TRAS IZQ	G55662	TRAS DER
G52094	DEL IZQ	G52095	DEL DER	G52221	DEL IZQ	G52222	DEL DER	G55663	DEL IZQ	G55664	DEL DER
G52096	DEL IZQ	G52097	DEL DER	G52223	DEL IZQ	G52224	DEL DER	G55667	DEL IZQ	G55666	DEL DER
G52103	TRAS IZQ	G52104	TRAS DER	G52225	DEL IZQ	G52226	DEL DER	G55669	TRAS IZQ	G55668	TRAS DER
G52105	DEL IZQ	G52106	DEL DER	G52227	DEL IZQ	G52228	DEL DER	G55671	DEL IZQ	G55670	DEL DER
G52107	DEL IZQ	G52108	DEL DER	G52235	DEL IZQ	G52236	DEL DER	G55675	TRAS IZQ	G55676	TRAS DER

COMBINACIONES IZQUIERDO / DERECHO

Struts Ultra (Continuado)				Struts Ultra (Continuado)				Struts Ultra (Continuado)			
G55738	DEL IZQ	G55737	DEL DER	G56556	DEL IZQ	G56555	DEL DER	G56721	DEL IZQ	G56722	DEL DER
G55785	DEL IZQ	G55784	DEL DER	G56559	DEL IZQ	G56558	DEL DER	G56723	DEL IZQ	G56724	DEL DER
G55832	DEL IZQ	G55833	DEL DER	G56562	DEL IZQ	G56561	DEL DER	G56728	TRAS IZQ	G56729	TRAS DER
G55858	DEL IZQ	G55857	DEL DER	G56570	DEL IZQ	G56569	DEL DER	G56730	DEL IZQ	G56731	DEL DER
G55860	TRAS IZQ	G55859	TRAS DER	G56573	DEL IZQ	G56576	DEL DER	G56732	TRAS IZQ	G56733	TRAS DER
G55866	DEL IZQ	G55865	DEL DER	G56575	TRAS IZQ	G56574	TRAS DER	G56734	TRAS IZQ	G56735	TRAS DER
G55868	TRAS IZQ	G55867	TRAS DER	G56580	TRAS IZQ	G56579	TRAS DER	G56739	DEL IZQ	G56736	DEL DER
G55882	DEL IZQ	G55881	DEL DER	G56582	DEL IZQ	G56581	DEL DER	G56740	DEL IZQ	G56741	DEL DER
G55884	TRAS IZQ	G55883	TRAS DER	G56586	DEL IZQ	G56585	DEL DER	G56750	DEL IZQ	G56751	DEL DER
G55894	TRAS IZQ	G55893	TRAS DER	G56589	DEL IZQ	G56588	DEL DER	G56752	DEL IZQ	G56753	DEL DER
G55903	DEL IZQ	G55904	DEL DER	G56601	DEL IZQ	G56568	DEL DER	G56754	DEL IZQ	G56755	DEL DER
G55913	DEL IZQ	G55912	DEL DER	G56602	DEL IZQ	G56603	DEL DER	G56756	DEL IZQ	G56757	DEL DER
G55920	DEL IZQ	G55921	DEL DER	G56604	DEL IZQ	G56605	DEL DER	G56759	DEL IZQ	G56758	DEL DER
G55924	DEL IZQ	G55923	DEL DER	G56615	DEL IZQ	G56616	DEL DER	G56761	DEL IZQ	G56760	DEL DER
G55926	DEL IZQ	G55925	DEL DER	G56618	DEL IZQ	G56619	DEL DER	G56764	TRAS IZQ	G56763	TRAS DER
G55928	TRAS IZQ	G55927	TRAS DER	G56621	DEL IZQ	G56622	DEL DER	G56766	DEL IZQ	G56765	DEL DER
G55930	TRAS IZQ	G55929	TRAS DER	G56625	DEL IZQ	G56624	DEL DER	G56768	TRAS IZQ	G56767	TRAS DER
G55932	TRAS IZQ	G55931	TRAS DER	G56627	DEL IZQ	G56626	DEL DER	G56771	DEL IZQ	G56770	DEL DER
G55934	TRAS IZQ	G55933	TRAS DER	G56629	TRAS IZQ	G56628	TRAS DER	G56773	DEL IZQ	G56774	DEL DER
G55958	DEL IZQ	G56758	DEL DER	G56631	DEL IZQ	G56632	DEL DER	G56775	DEL IZQ	G56776	DEL DER
G55970	DEL IZQ	G55971	DEL DER	G56634	DEL IZQ	G56633	DEL DER	G56782	DEL IZQ	G56781	DEL DER
G55977	TRAS IZQ	G55976	TRAS DER	G56636	DEL IZQ	G56635	DEL DER	G56785	DEL IZQ	G56784	DEL DER
G55978	DEL IZQ	G55960	DEL DER	G56637	TRAS IZQ	G56571	TRAS DER	G56787	DEL IZQ	G56786	DEL DER
G55993	DEL IZQ	G55994	DEL DER	G56640	TRAS IZQ	G56641	TRAS DER	G56794	DEL IZQ	G56793	DEL DER
G56506	DEL IZQ	G56514	DEL DER	G56642	DEL IZQ	G56643	DEL DER	G56796	DEL IZQ	G56795	DEL DER
G56512	TRAS IZQ	G56513	TRAS DER	G56644	TRAS IZQ	G56645	TRAS DER	G56798	DEL IZQ	G56797	DEL DER
G56516	DEL IZQ	G56517	DEL DER	G56649	DEL IZQ	G56650	DEL DER	G56800	DEL IZQ	G56799	DEL DER
G56524	TRAS IZQ	G56523	TRAS DER	G56661	DEL IZQ	G56660	DEL DER	G56804	DEL IZQ	G56803	DEL DER
G56526	DEL IZQ	G56525	DEL DER	G56667	TRAS IZQ	G56668	TRAS DER	G56806	DEL IZQ	G56805	DEL DER
G56528	TRAS IZQ	G56527	TRAS DER	G56669	DEL IZQ	G56670	DEL DER	G56813	DEL IZQ	G56814	DEL DER
G56530	DEL IZQ	G56529	DEL DER	G56671	DEL IZQ	G56672	DEL DER	G56816	DEL IZQ	G56815	DEL DER
G56532	DEL IZQ	G56531	DEL DER	G56673	DEL IZQ	G56674	DEL DER	G56819	DEL IZQ	G56820	DEL DER
G56534	TRAS IZQ	G56533	TRAS DER	G56675	TRAS IZQ	G56676	TRAS DER	G56822	TRAS IZQ	G56821	TRAS DER
G56536	DEL IZQ	G56535	DEL DER	G56677	DEL IZQ	G56678	DEL DER	G56836	DEL IZQ	G56837	DEL DER
G56538	TRAS IZQ	G56537	TRAS DER	G56679	DEL IZQ	G56680	DEL DER	G56840	DEL IZQ	G56841	DEL DER
G56539	DEL IZQ	G56540	DEL DER	G56681	TRAS IZQ	G56682	TRAS DER	G56842	DEL IZQ	G56843	DEL DER
G56542	TRAS IZQ	G56541	TRAS DER	G56683	DEL IZQ	G56684	DEL DER	G56882	DEL IZQ	G56883	DEL DER
G56544	DEL IZQ	G56543	DEL DER	G56685	DEL IZQ	G56686	DEL DER	G56884	TRAS IZQ	G56885	TRAS DER
G56546	TRAS IZQ	G56545	TRAS DER	G56687	DEL IZQ	G56688	DEL DER	G56886	DEL IZQ	G56887	DEL DER
G56548	DEL IZQ	G56547	DEL DER	G56689	DEL IZQ	G56690	DEL DER	G56888	DEL IZQ	G56889	DEL DER
G56552	DEL IZQ	G56551	DEL DER	G56706	DEL IZQ	G56705	DEL DER	G56890	DEL IZQ	G56891	DEL DER
G56554	TRAS IZQ	G56553	TRAS DER	G56720	DEL IZQ	G56719	DEL DER	G56892	DEL IZQ	G56893	DEL DER

COMBINACIONES IZQUIERDO / DERECHO

Struts Ultra (Continuado)				Struts Ultra (Continuado)				Struts Ultra (Continuado)			
G56895	DEL IZQ	G56896	DEL DER	G57049	DEL IZQ	G57050	DEL DER	142426	TRAS IZQ	142427	TRAS DER
G56897	TRAS IZQ	G56898	TRAS DER	G57054	DEL IZQ	G57055	DEL DER	142535	TRAS IZQ	142536	TRAS DER
G56979	DEL IZQ	G56978	DEL DER	G57057	TRAS IZQ	G57058	TRAS DER	142642	TRAS IZQ	142641	TRAS DER
G56982	DEL IZQ	G56983	DEL DER	G57061	TRAS IZQ	G57062	TRAS DER	142650	DEL IZQ	142649	DEL DER
55657	DEL IZQ	55658	DEL DER	G57063	DEL IZQ	G57064	DEL DER	142826	DEL IZQ	142825	DEL DER
55977	TRAS IZQ	55976	TRAS DER	G57065	DEL IZQ	G57066	DEL DER	143036	DEL IZQ	143037	DEL DER
56744	DEL IZQ	56743	DEL DER	G57067	TRAS IZQ	G57068	TRAS DER	143071	TRAS IZQ	143072	TRAS DER
G56917	DEL IZQ	G56916	DEL DER	G57069	DEL IZQ	G57070	DEL DER	143073	TRAS IZQ	143074	TRAS DER
G56919	DEL IZQ	G56918	DEL DER	G57071	DEL IZQ	G57072	DEL DER	143113	TRAS IZQ	143112	TRAS DER
G56921	DEL IZQ	G56920	DEL DER	G57073	DEL IZQ	G57074	DEL DER	143220	TRAS IZQ	143222	TRAS DER
G56924	TRAS IZQ	G56925	TRAS DER	G57076	DEL IZQ	G57077	DEL DER	143221	TRAS IZQ	143223	TRAS DER
G56930	DEL IZQ	G56931	DEL DER	G57078	TRAS IZQ	G57079	TRAS DER	143231	DEL IZQ	143264	DEL DER
G56932	TRAS IZQ	G56933	TRAS DER	G57081	DEL IZQ	G57082	DEL DER	143233	DEL IZQ	143265	DEL DER
G56934	DEL IZQ	G56937	DEL DER	G57084	DEL IZQ	G57085	DEL DER	143255	DEL IZQ	143266	DEL DER
G56949	TRAS IZQ	G56950	TRAS DER	G57086	TRAS IZQ	G57087	TRAS DER	143288	DEL IZQ	143289	DEL DER
G56952	TRAS IZQ	G56953	TRAS DER	G57088	DEL IZQ	G57089	DEL DER	143299	DEL IZQ	143300	DEL DER
G56954	TRAS IZQ	G56955	TRAS DER	G57090	TRAS IZQ	G57091	TRAS DER	143354	DEL IZQ	143355	DEL DER
G56956	DEL IZQ	G56957	DEL DER	G57093	DEL IZQ	G57094	DEL DER	143377	DEL IZQ	143378	DEL DER
G56958	DEL IZQ	G56959	DEL DER	G57097	DEL IZQ	G57098	DEL DER	143381	DEL IZQ	143382	DEL DER
G56962	DEL IZQ	G56963	DEL DER	G57099	DEL IZQ	G57100	DEL DER	143387	TRAS IZQ	143388	TRAS DER
G56968	TRAS IZQ	G56969	TRAS DER	G57101	DEL IZQ	G57102	DEL DER	143390	TRAS IZQ	143391	TRAS DER
G56970	DEL IZQ	G56971	DEL DER	G57105	DEL IZQ	G57106	DEL DER	G51188	DEL IZQ	G51189	DEL DER
G56973	TRAS IZQ	G56974	TRAS DER	G57107	DEL IZQ	G57108	DEL DER	G51761	DEL IZQ	G51760	DEL DER
G56976	DEL IZQ	G56977	DEL DER	G57110	DEL IZQ	G57111	DEL DER	G51810	DEL IZQ	G51811	DEL DER
G56989	DEL IZQ	G56990	DEL DER	G57112	DEL IZQ	G57113	DEL DER	G51813	DEL IZQ	G51814	DEL DER
G56991	DEL IZQ	G56992	DEL DER	G57114	DEL IZQ	G57115	DEL DER	G51827	DEL IZQ	G51828	DEL DER
G56993	DEL IZQ	G56994	DEL DER	G57116	DEL IZQ	G57117	DEL DER	G51853	DEL IZQ	G51854	DEL DER
G56996	DEL IZQ	G56997	DEL DER	G57119	DEL IZQ	G57120	DEL DER	G51875	TRAS IZQ	G51876	TRAS DER
G57001	DEL IZQ	G57002	DEL DER	G57121	DEL IZQ	G57122	DEL DER	G51877	DEL IZQ	G51878	DEL DER
G57003	TRAS IZQ	G57004	TRAS DER	G57123	DEL IZQ	G57124	DEL DER	G51889	TRAS IZQ	G51890	TRAS DER
G57007	DEL IZQ	G57008	DEL DER	G57126	DEL IZQ	G57127	DEL DER	G51896	DEL IZQ	G51897	DEL DER
G57011	DEL IZQ	G57012	DEL DER	G57128	TRAS IZQ	G57129	TRAS DER	G51912	TRAS IZQ	G51913	TRAS DER
G57028	DEL IZQ	G57029	DEL DER	G57130	DEL IZQ	G57131	DEL DER	G51917	DEL IZQ	G51918	DEL DER
G57030	DEL IZQ	G57031	DEL DER	G57133	DEL IZQ	G57134	DEL DER	G51920	DEL IZQ	G51921	DEL DER
G57032	TRAS IZQ	G57033	TRAS DER	G57135	DEL IZQ	G57136	DEL DER	G51947	DEL IZQ	G51948	DEL DER
G57034	DEL IZQ	G57035	DEL DER	G57137	DEL IZQ	G57138	DEL DER	G51953	DEL IZQ	G51954	DEL DER
G57037	DEL IZQ	G57038	DEL DER	G57139	DEL IZQ	G57140	DEL DER	G64004	TRAS IZQ	G64005	TRAS DER
G57041	DEL IZQ	G57042	DEL DER	G57144	DEL IZQ	G57145	DEL DER	61699	TRAS IZQ	61700	TRAS DER
G57043	TRAS IZQ	G57044	TRAS DER	142146	DEL IZQ	142145	DEL DER	G56759	DEL IZQ	G56758	DEL DER
G57045	DEL IZQ	G57046	DEL DER	142228	TRAS IZQ	142229	TRAS DER	G56759	DEL IZQ	G56758	DEL DER
G57047	DEL IZQ	G57048	DEL DER	142403	TRAS IZQ	142404	TRAS DER	G56761	DEL IZQ	G56760	DEL DER
				142408	DEL IZQ	142409	DEL DER	G56761	DEL IZQ	G56760	DEL DER

COMBINACIONES IZQUIERDO / DERECHO

Struts Ultra (Continuado)			Struts Ultra (Continuado)			ReadyMount Assembly (Continuado)		
G56764	TRAS IZQ	G56763 TRAS DER	G56884	TRAS IZQ	G56885 TRAS DER	G57003	TRAS IZQ	G57004 TRAS DER
G56766	DEL IZQ	G56765 DEL DER	G56886	DEL IZQ	G56887 DEL DER	G57007	DEL IZQ	G57008 DEL DER
G56766	DEL IZQ	G56765 DEL DER	G56886	DEL IZQ	G56887 DEL DER	G57011	DEL IZQ	G57012 DEL DER
G56768	TRAS IZQ	G56767 TRAS DER	G56888	DEL IZQ	G56889 DEL DER	G57028	DEL IZQ	G57029 DEL DER
G56771	DEL IZQ	G56770 DEL DER	G56888	DEL IZQ	G56889 DEL DER	G57030	DEL IZQ	G57031 DEL DER
G56771	DEL IZQ	G56770 DEL DER	G56888	DEL IZQ	G56889 DEL DER	G57032	TRAS IZQ	G57033 TRAS DER
G56773	DEL IZQ	G56774 DEL DER	G56890	DEL IZQ	G56891 DEL DER	G57034	DEL IZQ	G57035 DEL DER
G56773	DEL IZQ	G56774 DEL DER	G56890	DEL IZQ	G56891 DEL DER	G57037	DEL IZQ	G57038 DEL DER
G56775	DEL IZQ	G56776 DEL DER	G56890	DEL IZQ	G56891 DEL DER	G57041	DEL IZQ	G57042 DEL DER
G56775	DEL IZQ	G56776 DEL DER	G56892	DEL IZQ	G56893 DEL DER	G57043	TRAS IZQ	G57044 TRAS DER
G56782	DEL IZQ	G56781 DEL DER	G56892	DEL IZQ	G56893 DEL DER	G57045	DEL IZQ	G57046 DEL DER
G56782	DEL IZQ	G56781 DEL DER	G56895	DEL IZQ	G56896 DEL DER	G57047	DEL IZQ	G57048 DEL DER
G56785	DEL IZQ	G56784 DEL DER	G56897	TRAS IZQ	G56898 TRAS DER	G57049	DEL IZQ	G57050 DEL DER
G56785	DEL IZQ	G56784 DEL DER	G56979	DEL IZQ	G56978 DEL DER	G57054	DEL IZQ	G57055 DEL DER
G56787	DEL IZQ	G56786 DEL DER	G56982	DEL IZQ	G56983 DEL DER	G57057	TRAS IZQ	G57058 TRAS DER
G56787	DEL IZQ	G56786 DEL DER	Struts Guardian Hidráulico			G57061	TRAS IZQ	G57062 TRAS DER
G56794	DEL IZQ	G56793 DEL DER	55657	DEL IZQ	55658 DEL DER	G57063	DEL IZQ	G57064 DEL DER
G56794	DEL IZQ	G56793 DEL DER	55977	TRAS IZQ	55976 TRAS DER	G57065	DEL IZQ	G57066 DEL DER
G56796	DEL IZQ	G56795 DEL DER	56744	DEL IZQ	56743 DEL DER	G57067	TRAS IZQ	G57068 TRAS DER
G56796	DEL IZQ	G56795 DEL DER	ReadyMount Assembly			G57069	DEL IZQ	G57070 DEL DER
G56798	DEL IZQ	G56797 DEL DER	G56917	DEL IZQ	G56916 DEL DER	G57071	DEL IZQ	G57072 DEL DER
G56798	DEL IZQ	G56797 DEL DER	G56919	DEL IZQ	G56918 DEL DER	G57073	DEL IZQ	G57074 DEL DER
G56800	DEL IZQ	G56799 DEL DER	G56921	DEL IZQ	G56920 DEL DER	G57076	DEL IZQ	G57077 DEL DER
G56800	DEL IZQ	G56799 DEL DER	G56924	TRAS IZQ	G56925 TRAS DER	G57078	TRAS IZQ	G57079 TRAS DER
G56804	DEL IZQ	G56803 DEL DER	G56930	DEL IZQ	G56931 DEL DER	G57081	DEL IZQ	G57082 DEL DER
G56804	DEL IZQ	G56803 DEL DER	G56932	TRAS IZQ	G56933 TRAS DER	G57084	DEL IZQ	G57085 DEL DER
G56806	DEL IZQ	G56805 DEL DER	G56934	DEL IZQ	G56937 DEL DER	G57086	TRAS IZQ	G57087 TRAS DER
G56806	DEL IZQ	G56805 DEL DER	G56949	TRAS IZQ	G56950 TRAS DER	G57088	DEL IZQ	G57089 DEL DER
G56813	DEL IZQ	G56814 DEL DER	G56952	TRAS IZQ	G56953 TRAS DER	G57090	TRAS IZQ	G57091 TRAS DER
G56813	DEL IZQ	G56814 DEL DER	G56954	TRAS IZQ	G56955 TRAS DER	G57093	DEL IZQ	G57094 DEL DER
G56816	DEL IZQ	G56815 DEL DER	G56956	DEL IZQ	G56957 DEL DER	G57097	DEL IZQ	G57098 DEL DER
G56819	DEL IZQ	G56820 DEL DER	G56958	DEL IZQ	G56959 DEL DER	G57099	DEL IZQ	G57100 DEL DER
G56819	DEL IZQ	G56820 DEL DER	G56962	DEL IZQ	G56963 DEL DER	G57101	DEL IZQ	G57102 DEL DER
G56822	TRAS IZQ	G56821 TRAS DER	G56968	TRAS IZQ	G56969 TRAS DER	G57105	DEL IZQ	G57106 DEL DER
G56836	DEL IZQ	G56837 DEL DER	G56970	DEL IZQ	G56971 DEL DER	G57107	DEL IZQ	G57108 DEL DER
G56836	DEL IZQ	G56837 DEL DER	G56973	TRAS IZQ	G56974 TRAS DER	G57110	DEL IZQ	G57111 DEL DER
G56840	DEL IZQ	G56841 DEL DER	G56976	DEL IZQ	G56977 DEL DER	G57112	DEL IZQ	G57113 DEL DER
G56840	DEL IZQ	G56841 DEL DER	G56989	DEL IZQ	G56990 DEL DER	G57114	DEL IZQ	G57115 DEL DER
G56842	DEL IZQ	G56843 DEL DER	G56991	DEL IZQ	G56992 DEL DER	G57116	DEL IZQ	G57117 DEL DER
G56842	DEL IZQ	G56843 DEL DER	G56993	DEL IZQ	G56994 DEL DER	G57119	DEL IZQ	G57120 DEL DER
G56882	DEL IZQ	G56883 DEL DER	G56996	DEL IZQ	G56997 DEL DER	G57121	DEL IZQ	G57122 DEL DER
G56882	DEL IZQ	G56883 DEL DER	G57001	DEL IZQ	G57002 DEL DER			

COMBINACIONES IZQUIERDO / DERECHO

ReadyMount Assembly (Continuado)

G57123 DEL IZQ G57124 DEL DER
 G57126 DEL IZQ G57127 DEL DER
 G57128 TRAS IZQ G57129 TRAS DER
 G57128 TRAS IZQ G57129 TRAS DER
 G57130 DEL IZQ G57131 DEL DER
 G57133 DEL IZQ G57134 DEL DER
 G57135 DEL IZQ G57136 DEL DER
 G57137 DEL IZQ G57138 DEL DER
 G57139 DEL IZQ G57140 DEL DER
 G57144 DEL IZQ G57145 DEL DER

Bases de Struts

142146 DEL IZQ 142145 DEL DER
 142146 DEL IZQ 142145 DEL DER
 142228 TRAS IZQ 142229 TRAS DER
 142403 TRAS IZQ 142404 TRAS DER
 142408 DEL IZQ 142409 DEL DER
 142408 DEL IZQ 142409 DEL DER
 142426 TRAS IZQ 142427 TRAS DER
 142535 TRAS IZQ 142536 TRAS DER
 142642 TRAS IZQ 142641 TRAS DER
 142650 DEL IZQ 142649 DEL DER
 142650 DEL IZQ 142649 DEL DER
 142826 DEL IZQ 142825 DEL DER
 142826 DEL IZQ 142825 DEL DER
 143036 DEL IZQ 143037 DEL DER
 143036 DEL IZQ 143037 DEL DER
 143036 DEL IZQ 143037 DEL DER
 143071 TRAS IZQ 143072 TRAS DER
 143073 TRAS IZQ 143074 TRAS DER
 143113 TRAS IZQ 143112 TRAS DER
 143220 TRAS IZQ 143222 TRAS DER
 143221 TRAS IZQ 143223 TRAS DER
 143231 DEL IZQ 143264 DEL DER
 143231 DEL IZQ 143264 DEL DER
 143233 DEL IZQ 143265 DEL DER
 143233 DEL IZQ 143265 DEL DER
 143255 DEL IZQ 143266 DEL DER
 143255 DEL IZQ 143266 DEL DER
 143288 DEL IZQ 143289 DEL DER
 143299 DEL IZQ 143300 DEL DER
 143354 DEL IZQ 143355 DEL DER
 143354 DEL IZQ 143355 DEL DER

Bases de Struts (Continuado)

143377 DEL IZQ 143378 DEL DER
 143377 DEL IZQ 143378 DEL DER
 143381 DEL IZQ 143382 DEL DER
 143381 DEL IZQ 143382 DEL DER
 143387 TRAS IZQ 143388 TRAS DER
 143390 TRAS IZQ 143391 TRAS DER

Asiento de Resorte Ultra

G51188 DEL IZQ G51189 DEL DER
 G51188 DEL IZQ G51189 DEL DER
 G51761 DEL IZQ G51760 DEL DER
 G51761 DEL IZQ G51760 DEL DER
 G51810 DEL IZQ G51811 DEL DER
 G51810 DEL IZQ G51811 DEL DER
 G51813 DEL IZQ G51814 DEL DER
 G51813 DEL IZQ G51814 DEL DER
 G51827 DEL IZQ G51828 DEL DER
 G51827 DEL IZQ G51828 DEL DER
 G51853 DEL IZQ G51854 DEL DER
 G51853 DEL IZQ G51854 DEL DER
 G51875 TRAS IZQ G51876 TRAS DER
 G51877 DEL IZQ G51878 DEL DER
 G51877 DEL IZQ G51878 DEL DER
 G51889 TRAS IZQ G51890 TRAS DER
 G51896 DEL IZQ G51897 DEL DER
 G51896 DEL IZQ G51897 DEL DER
 G51912 TRAS IZQ G51913 TRAS DER
 G51917 DEL IZQ G51918 DEL DER
 G51917 DEL IZQ G51918 DEL DER
 G51920 DEL IZQ G51921 DEL DER
 G51947 DEL IZQ G51948 DEL DER
 G51947 DEL IZQ G51948 DEL DER
 G51953 DEL IZQ G51954 DEL DER

Amortiguadores para Camioneta Ultra

61699 TRAS IZQ 61700 TRAS DER

Amortiguadores ProGuard

G64004 TRAS IZQ G64005 TRAS DER

ESPECIFICACIONES POR NÚMERO DE PARTE

AMORTIGUADORES DE DIRECCIÓN

No. Parte Catálogo	Longitud Extendida	Longitud Comp.	Carrera	Montaje Superior	Montaje Inferior	No. Parte Catálogo	Longitud Extendida	Longitud Comp.	Carrera	Montaje Superior	Montaje Inferior
14004	16.77	11.28	6.20			14040	20.7	12.12	3.51	ES41	ES41
14010	21.4	9.41	5.08			14071	19.73	12.12	7.61	EB1	ES24
14016	24.04	10.45	6.32	ES35	ES35	14072					
14017	21.37	12.33	9.07	S1	S1	14074					
14018	26.87	14.43	9.61	EB1	EB1	14075					
14019	19.75	12.8	8.57	ES35	EB1	14076					
14020	15.73	15.55	11.32	ES35	EB1	14077					
14039	19.73	12.05	7.70	EB1	ES39						

AMORTIGUADORES DE CARGA TRASEROS

No. Parte Catálogo	Longitud Extendida	Longitud Comp.	Carrera	Montaje Superior	Montaje Inferior	No. Parte Catálogo	Longitud Extendida	Longitud Comp.	Carrera	Montaje Superior	Montaje Inferior
34036	14.16	9.53	4.63	EB1	ES24	43099	19.17	11.77	7.40	S1	ES25
34051	13.28	8.67	4.61	S1	BP30	43107	17.95	11.37	6.58	ES31	ES24
34052	13.62	9	4.62	S1	BP13	43111	22.9	13.82	9.08	ES34	ES34
34057	15.01	10.14	4.87	S12	ES41	43138	18.18	11.1	7.08	ES27	S12
34058	17.13	11.01	6.12	S12	ES3	43140	20.92	12.84	8.08	S1	EB1
34073	14.29	9.37	4.92	S1	BP7	43142	21.45	13.12	8.33	ES185	ES185
34076	14.59	9.87	4.72	S36	EB1	43143	20.42	12.34	8.08	S1	ES91
43048	20.45	12.62	7.83	EB1	EB1	43161	22.3	13.69	8.61	ES18	ES18
43049	21.86	13.28	8.58	BP31	EB1	43162	22.99	14.38	8.61	BP14	ES34
43058	19.95	12.37	7.58	EB1	ES25	43163	25.05	15.69	9.36	BP14	ES34
43060	20.2	12.55	7.65	EB1	BP31	43165	22.99	13.88	9.11	ES106	ES106
43062	18.95	11.87	7.08	ES24	ES24	43167	22.99	13.88	9.11	ES185	ES185
43067	24.61	14.78	9.83	ES27	EB4	43171	24.74	15.38	9.36	BP14	ES185
43084	21.42	12.84	8.58	BP14	S1	43172	25.55	16.19	9.36	BP14	ES185
43085	20.61	12.78	7.83	EB4	ES27	43173	15.39	10.38	5.01	ES69	ES69
43093	20.2	12.62	7.58	ES24	ES24	43180	23.55	14.19	9.36	BP8	ES34
43096	22.61	13.78	8.83	ES27	EB4	43181	24.24	14.88	9.36	ES34	ES34

ESPECIFICACIONES POR NÚMERO DE PARTE

AMORTIGUADORES GUARDIAN HIDRÁULICOS

No. Parte Catálogo	Longitud Extendida	Longitud Comp.	Carrera	Montaje Superior	Montaje Inferior	No. Parte Catálogo	Longitud Extendida	Longitud Comp.	Carrera	Montaje Superior	Montaje Inferior
40025						42958					
40026	14.51	9.63	4.88			42959					
40027	23.01	13.78	9.23			42960					
42094	15.98	10.37	5.61			42961					
42161	17.2	12.44	4.76			42962					
42446						42963					
42459	21.78	13.42	8.36			42964					
42508	21.6	13.34	8.26			42965					
42517						42966					
42520	17.77	13.29	4.48			42967					
42530						42968					
42577	17.23	10.87	6.36			42969					
42952	23	13.89	9.11			42970					
42953						42971					
42954	15.28	10.67	4.61			42972					
42955	12.78	9.67	3.11			42973					
42957											

CARTUCHOS HIDRÁULICOS

No. Parte Catálogo	Longitud Extendida	Longitud Comp.	Carrera	Montaje Superior	Montaje Inferior	No. Parte Catálogo	Longitud Extendida	Longitud Comp.	Carrera	Montaje Superior	Montaje Inferior
44763	19.95	13.82				44902	21.78	14.37			

AMORTIGUADORES DE AIRE HIJACKERS

No. Parte Catálogo	Longitud Extendida	Longitud Comp.	Carrera	Montaje Superior	Montaje Inferior	No. Parte Catálogo	Longitud Extendida	Longitud Comp.	Carrera	Montaje Superior	Montaje Inferior
49105	18.21	11.23	6.98	S1	S1	49157	21.37	13.29	8.08	BP14	EB1
49106	22.43	13.95	8.48	ES26	EB4	49162	20.02	12.79	7.23	ES24	ES24
49107	19.27	12.29	6.98	ES24	ES24	49173	19.24	12.01	7.23	S1	ES25
49110	22.08	13.85	8.23	EB4	EB4	49178	23.12	13.89	9.23	S1	ES25
49114	20.24	12.51	7.73	S1	EB1	49193	21.27	13.29	7.98	BP14	ES10
49122	21.62	13.14	8.48	S1	ES10	49196	23.74	14.26	9.48	S1	ES185
49127	19.87	12.63	7.24	EB1	ES25	49197	21.27	13.29	7.98	EB1	ES185
49128	22.77	14.04	8.73	BP14	EB1	49199	20.68	12.7	7.98	S1	ES91
49131	22.15	13.67	8.48	BP31	EB1	49203	20.24	12.51	7.73	S1	EB1
49135	21.62	13.14	8.48	BP14	S1	49205	21.12	13.13	7.99	S1	EB1
49149	24.93	15.64	9.29	ES27	EB4	49207	22.81	14.06	8.75	EB1	ES106
49151	20.35	12.83	7.52	EB1	EB1	49212	21.02	13.29	7.73	ES27	ES27
49152	20.27	13.04	7.23	BP31	EB1	49213	24.27	14.79	9.48	BP14	ES34
49155	23.27	14.29	8.98	EB1	ES34	49214	23.27	14.29	8.98	EB1	ES41

ESPECIFICACIONES POR NÚMERO DE PARTE

AMORTIGUADORES DE AIRE HIJACKERS (CONTINUADO)

No. Parte Catálogo	Longitud Extendida	Longitud Comp.	Carrera	Montaje Superior	Montaje Inferior	No. Parte Catálogo	Longitud Extendida	Longitud Comp.	Carrera	Montaje Superior	Montaje Inferior
49215	23.02	14.16	8.86	ES18	ES18	49241	25.77	15.54	10.23	EB1	ES185
49216	20.74	12.76	7.98	S12	BP7	49254	17.86	12.45	5.41	S69	ES15
49217	25.27	15.29	9.98	EB1	ES185	49255	24.54	14.66	9.87		
49218	26.34	16.36	9.98	BP14	ES34	49304	14.35	9.75	4.60	ES10	EB1
49221	18.36	11.88	6.48	ES141	ES25	49307	16.35	10.75	5.60	ES17	ES17
49222	18.77	12.04	6.73	EB1	ES25	49309	18.52	11.5	7.02	EB1	S1
49223	23.27	14.29	8.98	EB1	ES41	49310	20.35	12.75	7.60	EB1	EB1
49225	25.77	15.54	10.23	BP14	ES185	49311	22.44	14	8.44	EB1	EB1
49226	20.77	13.04	7.73	BP20	EB1	49334	20.7	13.05	7.65	BP31	EB1
49228	24.47	14.74	9.73	S15	BP14	49345	22.6	15.16	7.44	ES18	ES21
49229	23.99	15.11	8.88	ES152	ES153	49346	18.08	11.48	6.60	ES27	S12
49230	20.27	12.79	7.48	ES185	ES185	49369	21.86	13.51	8.35	ES84	ES84
49231	24.27	14.79	9.48	BP14	ES34	49370	21.6	15.04	6.56	S29	ES84
49232	25.09	15.16	9.93	BP14	ES185	49371	22.55	13.7	8.85	S29	ES53
49233	15.67	10.79	4.88	ES69	ES69	49381					
49234	19.77	13.98	5.79	S1	ES185	49387	21.14	13.03	8.11	S12	EB2
49235	24.77	15.04	9.73	ES34	ES34	49388	21.79	13.39	8.40	S12	EB2
49236	17.77	11.54	6.23	ES18	ES18	49613	19.12	11.97	7.15	S1	ES185
49237	24.18	14.45	9.73	S12	ES171	49614	19.04	11.94	7.10	S29	ES24

STRUTS HIDRÁULICOS

No. Parte Catálogo	Longitud Extendida	Longitud Comp.	Carrera	Montaje Superior	Montaje Inferior	No. Parte Catálogo	Longitud Extendida	Longitud Comp.	Carrera	Montaje Superior	Montaje Inferior
51006	21.01	13.25	7.76			55745	19.65	13.33	6.32		
51022	24.76	16.75	8.01			55746	20.31	11.56	8.75		
51091						55976	20.22	12.11	8.11		
51294						55977	20.22	12.11	8.11		
55514	16.98	10.4	6.58			55991	17.85	11.52	6.33		
55526	17.4	10.83	6.58			56630	18.35	12.47	5.88		
55657	17.22	10.93	6.3			56743					
55658	17.22	10.93	6.3			56744					
55713	17.8	11.44	6.36			56980	16.42	8.88	7.54		

AMORTIGUADORES LTV

No. Parte Catálogo	Longitud Extendida	Longitud Comp.	Carrera	Montaje Superior	Montaje Inferior	No. Parte Catálogo	Longitud Extendida	Longitud Comp.	Carrera	Montaje Superior	Montaje Inferior
58183	21.18	13.3	7.88	EB4	EB4	58357	14.68	10.06	4.62	ES24	ES24
58347	17.87	11.49	6.38	ES31	ES24	58359	13.92	9.14	4.78	S1	BP13
58349	23.18	14.3	8.88	EB1	ES34	58360	15.42	9.89	5.53	S1	BP13
58350	18.6	11.65	6.95	S1	ES25	58366	23.18	14.3	8.88	ES34	ES34
58353	24.52	14.9	9.62	ES27	EB4	58377	19.87	12.49	7.38	EB1	ES25
58355	14.87	10.11	4.76	EB11	ES24	58386	16.04	10.66	5.38	S36	ES25

ESPECIFICACIONES POR NÚMERO DE PARTE

AMORTIGUADORES LTV (CONTINUADO)

No. Parte Catálogo	Longitud Extendida	Longitud Comp.	Carrera	Montaje Superior	Montaje Inferior	No. Parte Catálogo	Longitud Extendida	Longitud Comp.	Carrera	Montaje Superior	Montaje Inferior
58387	23.15	14.03	9.12	S1	ES25	58716	15.74	10.37	5.37	S62	ES26
58389	29.02	17.15	11.87	ES27	ES27	58717	22.87	13.99	8.88	ES25	ES25
58394	15.68	10.56	5.12	ES24	EB1	58778	24.34	14.46	9.88	S12	ES171
58403	24.48	14.95	9.53	ES26	ES26	58783	14.59	10.21	4.38	S12	BP11
58406	22.87	13.99	8.88	EB1	ES185	58803	15.24	10.37	4.87	S12	U Bracket
58409	21.37	13.24	8.13	EB1	ES185	58807	15.24	10.11	5.13	S36	EB1
58410	18.62	11.75	6.87	S12	EB1	58808	28.38	16.75	11.63	ES41	ES41
58411	18.68	12.06	6.62	ES31	ES26	58809	23.65	14.53	9.12	EB1	ES185
58412	26.68	16.18	10.50	ES34	ES34	58810	31.42	18.42	13.00	EB1	ES185
58413	20.68	13.06	7.62	ES27	ES27	58811	25.36	15.23	10.13	EB1	ES185
58414	15.04	10.16	4.88	S36	ES41	58812	22.45	14.07	8.38	ES86	EB20
58416	18.42	11.8	6.62	S12	ES25	58817	15.59	10.96	4.63	S12	ES60
58421	13.42	8.89	4.53	S1	BP30	58901	16.49	10.87	5.62	ES126	ES34
58422	23.87	14.49	9.38	BP14	ES34	58906	19.98	12.7	7.28	ES27	ES27
58423	16.45	10.67	5.78	ES26	ES26	58908	18.2	11.67	6.53	ES31	ES24
58437	22.99	14.09	8.90	ES31	ES24	58929	14.54	9.76	4.78	S36	EB1
58438	29.68	17.55	12.13	EB1	ES34	58930	22.81	14.06	8.75	ES34	ES34
58455	22.87	13.99	8.88	ES41	ES41	58943					
58456	26.68	16.06	10.62	ES25	ES25	58944					
58461	25.37	15.24	10.13	ES185	ES185	58945					
58488	26.68	16.05	10.63	BP14	ES34	51006	21.01	13.25	7.76		
58489	14.64	9.61	5.03	S29	BP11	51022	24.76	16.75	8.01		
58500	15.04	10.16	4.88	S36	ES185	51091					
58609	16.49	11.05	5.44	ES126	ES45	51294					
58617	27.37	16.24	11.13	ES83	ES83	55514	16.98	10.4	6.58		
58622	15.04	10.16	4.88	S36	EB1	55526	17.4	10.83	6.58		
58623	22.54	13.91	8.63	S36	ES185	55657	17.22	10.93	6.3		
58624	20.04	12.66	7.38	S36	ES185	55658	17.22	10.93	6.3		
58625	22.36	13.83	8.53	EB1	EB20	55713	17.8	11.44	6.36		
58638	23.87	14.49	9.38	BP14	ES34	55745	19.65	13.33	6.32		
58661	14.22	9.59	4.63	S38	ES34	55746	20.31	11.56	8.75		
58662	24.68	15.36	9.32	ES34	ES34	55976	20.22	12.11	8.11		
58671	22.2	13.67	8.53	ES26	ES26	55977	20.22	12.11	8.11		
58673	22.72	13.84	8.88	S38	ES34	55991	17.85	11.52	6.33		
58674	23.22	14.09	9.13	S38	ES34	56630	18.35	12.47	5.88		
58675	26.13	15.87	10.26	ES34	ES34	56743					
58714	15.26	9.98	5.28	S62	BP7	56744					
58715	28.34	16.46	11.88	S12	ES171	56980	16.42	8.88	7.54		

ESPECIFICACIONES POR NÚMERO DE PARTE

AMORTIGUADORES PROGUARD

No. Parte Catálogo	Longitud Extendida	Longitud Comp.	Carrera	Montaje Superior	Montaje Inferior	No. Parte Catálogo	Longitud Extendida	Longitud Comp.	Carrera	Montaje Superior	Montaje Inferior
61500	20.23	12.37	7.86	EB1	EB1	61546	18.45	11.67	6.78	S1	ES64
61501	12.6	8.59	4.01	S1	ES64	61547	23.01	14.07	8.94	ES185	ES185
61502	20.67	12.06	8.61	S8	S1	61549	15.89	10.11	5.78	S1	EB1
61503	21.12	16.31	4.81	S29	ES84	61550	17.73	11.12	6.61	EB1	EB1
61504	13.7	8.92	4.78	S1	BP30	61551	22.45	13.42	9.03	S1	ES25
61505	18.95	11.67	7.28	EB1	S1	61552	13.95	9.17	4.78	S1	ES113
61506	21.86	13.58	8.28	EB1	EB1	61553	15.09	10.06	5.03	S36	ES25
61507	21.11	12.83	8.28	S1	EB2	61554	21.48	13.2	8.28	ES185	ES185
61508	14.11	9	5.11	S1	ES64	61555	14.14	9.11	5.03	S12	BP7
61509	14.7	9.34	5.36	S1	BP14	61556	14.2	9.09	5.11	S1	BP7
61510	22.29	13.76	8.53	EB2	EB2	61557	18.42	11.88	6.54	ES141	ES25
61511	23.16	14.13	9.03	BP13	ES27	61558	22.45	13.42	9.03	S1	EB1
61512	13.2	8.59	4.61	S1	BP7	61559	22.98	13.95	9.03	EB1	ES185
61513	19.95	12.42	7.53	S8	EB1	61560	18.45	11.67	6.78	S1	ES185
61516	18.23	11.37	6.86	ES31	ES24	61561	15.09	10.06	5.03	S36	EB1
61517	14.98	9.95	5.03	ES24	ES24	61565	24.26	14.73	9.53	BP14	ES34
61518	18.73	11.7	7.03	S1	ES25	61568	19.64	12.36	7.28	EB1	ES142
61519	19.98	12.45	7.53	EB1	ES25	61569	16.33	10.8	5.53	S12	BP7
61520	15.34	10.31	5.03	S36	ES41	61573	26.98	15.95	11.03	EB1	ES185
61521	16.45	10.67	5.78	S12	ES25	61575	21.14	13.36	7.78	EB5	ES24
61522	20.49	12.63	7.86	ES27	ES27	61582	24.98	14.95	10.03	EB1	EB1
61523	13.7	8.92	4.78	S1	BP13	61584	25.48	15.2	10.28	BP13	ES26
61524	23.26	14.23	9.03	EB1	ES34	61586	22.95	13.67	9.28	S1	EB1
61525	15.01	9.95	5.06	EB1	ES24	61588	21.11	13.08	8.03	S12	EB2
61526	24.64	14.86	9.78	ES27	EB4	61589	21.29	13.51	7.78	ES152	ES153
61528	23.98	14.45	9.53	BP14	ES34	61590	25.48	15.2	10.28	BP14	ES185
61529	14.1	9.34	4.76	S1	BP4	61591	14.47	9.71	4.76	S36	EB1
61530	25.48	15.2	10.28	EB1	ES185	61592	21.45	13.17	8.28	S47	EB1
61531	16.73	10.7	6.03	ES26	ES26	61593	14.95	9.67	5.28	S1	ES64
61532	23.98	14.45	9.53	EB1	EB1	61594	19.45	12.17	7.28	EB1	S17
61533	22.98	13.95	9.03	EB1	ES106	61595	20.07	12.54	7.53	S36	ES185
61534	26.98	15.95	11.03	EB1	ES106	61596	14.45	9.42	5.03	S1	ES69
61535	20.45	12.67	7.78	S1	BP7	61597	24.14	14.61	9.53	ES104	ES69
61536	19.98	12.45	7.53	BP20	EB1	61598	23.79	15.01	8.78	ES152	ES153
61538	17.98	11.45	6.53	ES18	ES18	61599	13.8	9.52	4.28	S38	ES34
61539	22.79	14.01	8.78	ES141	ES141	61600	24.51	14.98	9.53	ES34	ES34
61540	13.7	8.92	4.78	S1	BP4	61601	14.71	9.49	5.22	S1	ES83
61541	18.14	11.61	6.53	EB5	ES25	61605	17.98	11.45	6.53	ES18	ES18
61542	16.73	10.95	5.78	ES126	ES128	61606	14.7	9.34	5.36	S1	BP19
61543	26.76	16.23	10.53	BP14	ES34	61607	15.89	10.11	5.78	S12	ES64
61544	14.54	9.75	4.79	S29	BP11	61608	19.64	12.36	7.28	ES99	ES48
61545	14.45	9.67	4.78	S1	ES64	61609	22.48	13.7	8.78	ES110	ES19

ESPECIFICACIONES POR NÚMERO DE PARTE

AMORTIGUADORES PROGUARD (CONTINUADO)

No. Parte Catálogo	Longitud Extendida	Longitud Comp.	Carrera	Montaje Superior	Montaje Inferior	No. Parte Catálogo	Longitud Extendida	Longitud Comp.	Carrera	Montaje Superior	Montaje Inferior
61610	19.04	11.76	7.28	S1	ES153	61670					
61611	15.48	9.95	5.53	S62	BP7	61671					
61612	28.39	16.36	12.03	S12	ES171	61672					
61613	15.48	9.95	5.53	S62	ES26	61674					
61614	22.98	13.95	9.03	ES41	ES41	61675	22.81	14.12	8.69	ES34	ES34
61615	20.3	12.27	8.03	S12	BP11	61676	21.25	13.31	7.94	ES88	ES65
61616	19.39	12.23	7.16	BP20	ES24	61679	14.71	9.49	5.22	S1	ES25
61623	18.04	13.51	4.53	S36	BP7	61680	20.83	13.39	7.44	S38	ES34
61624	24.98	14.95	10.03	BP14	ES185	61681	29.71	17.77	11.94	EB1	ES41
61625	15.48	10.45	5.03	ES69	ES69	61682	31.36	18.67	12.69	EB1	ES41
61626	13.73	9.45	4.28	S36	BP10	61683	15.07	10.44	4.63	S11	U Bracket
61627	22.98	13.95	9.03	ES185	ES185	61684	12.82	8.88	3.94	S11	BP9
61629	26.98	15.95	11.03	ES185	ES185	61685	14.12	9.68	4.44	S11	BP9
61632	20.79	13.01	7.78	EB4	EB4	61686	22.36	13.92	8.44	BP14	ES34
61633	28.64	16.86	11.78	ES27	EB4	61687	23.87	14.68	9.19	BP14	ES34
61634	22.3	13.77	8.53	S38	ES34	61688	25.19	15.31	9.88	BP14	ES34
61635	23.27	14.24	9.03	S38	ES34	61690	24.78	15.84	8.94	EB20	EB20
61637	17.98	11.45	6.53	EB1	EB1	61691	26.51	16.12	10.39	ES34	ES34
61638	24.45	14.42	10.03	S12	ES171	61692	26.05	15.87	10.18	ES34	ES34
61641	14.7	10.17	4.53	S12	BP11	61693					
61642	26.76	15.98	10.78	ES34	ES34	61694					
61643	15.36	10.33	5.03	S12	U Bracket	61696	22.45	14.5	7.95	BP18	ES26
61646	22.57	14.29	8.28	S36	ES185	61697	22.62	14.43	8.19	BP18	ES26
61647	23.23	13.95	9.28	S1	ES25	61699	19.41	12.65	6.76	EB2	EB2
61649	23.26	14.23	9.03	ES34	ES34	61700	20.37	13.11	7.26	EB2	EB2
61650	15.7	9.92	5.78	S1	BP13	61703	20.15	13.96	6.19	ES83	ES83
61651	24.4	14.64	9.76	S47	EB1	61704	16.84	11.28	5.56	ES69	ES69
61653						61709	27.58	17.14	10.44	ES34	ES34
61654	28.76	16.98	11.78	ES185	ES185	61710	27.58	17.14	10.44	ES34	ES34
61655	23.01	14.07	8.94	ES185	ES185	61711	21.8	13.61	8.19	S36	ES26
61656	31.51	18.48	13.03	ES185	ES185	61712	23.3	14.26	9.04	S38	ES34
61657	25.48	15.2	10.28	ES185	ES185	61713	26.94	16	10.94	EB1	ES83
61658	24.48	14.7	9.78	ES26	ES26	61714	23.36	14.22	9.14	S62	ES77
61659	20.76	12.98	7.78	ES185	ES185	61715	24.12	15.18	8.94	ES88	ES69
61662	12.23	8.45	3.78	S47	ES64	61716	26.5	16.33	10.17	ES34	ES34
61663	15.7	10.92	4.78	S12	ES60	61717	22.75	14.56	8.19	ES47	ES26
61664	20.45	12.67	7.78	S1	BP7	61718	21.33	13.64	7.69	ES128	ES45
61665						61720	15.92	11.23	4.69	ES17	ES19
61666						61732					
61667						61734					
61668						61777	15.62	10.68	4.94	ES164	ES68
61669											

ESPECIFICACIONES POR NÚMERO DE PARTE

AMORTIGUADORES ULTRA

No. Parte Catálogo	Longitud Extendida	Longitud Comp.	Carrera	Montaje Superior	Montaje Inferior	No. Parte Catálogo	Longitud Extendida	Longitud Comp.	Carrera	Montaje Superior	Montaje Inferior
69407	18.92	11.56	7.36	S29	ES24	69671	18.1	11.34	6.76	S1	ES133
69416	20.15	13.45	6.70	ES3	ES56	69674	21.2	12.84	8.36	S1	ES64
69417	18.25	11.99	6.26	ES71	ES121	69675	14.61	9.25	5.36	S1	BP7
69420	22.81	14.68	8.13	S1	EB3	69676	19.7	11.84	7.86	S1	EB1
69450	26.25	16	10.25	S48	EB5	69677	18.45	11.34	7.11	S1	ES8
69462	24.11	15.01	9.10	S50	ES80	69683					
69464	24.2	15.93	8.27	384557-1	ES41	69689	15.63	10.37	5.26	ES85	ES85
69465	17.94	12.78	5.16	ES162	ES65	69703	17.95	11.09	6.86	ES27	S12
69473	18.29	11.43	6.86	ES85	ES30	69704	10.67	7.06	3.61	S1	S12
69573	15.41	10.4	5.01			69706	13.46	9.95	3.51	ES86	ES34
69574	20.26	12.5	7.76	S36	ES7	69709	23.7	13.84	9.86	S1	ES185
69575	20.16	12.4	7.76	S36	ES162	69713	23.85	14.59	9.26	S17	EB1
69577						69714	14.1	9.94	4.16	S1	BP17
69579	18.66	15.59	3.07			69715	13.98	9.37	4.61	ES18	ES110
69580	17.45	11.15	6.3			69723	21.12	16.31	4.81	S29	ES84
69581	11.77	8.61	3.16			69724	22.14	13.28	8.86	BP31	EB1
69582	13.16	9.05	4.11			69725	21.6	13.09	8.51	S1	ES69
69583	16.19	10.58	5.61			69726	17.7	13.54	4.16		
69584						69727	13.13	9.12	4.01	BP14	ES53
69585	22.5	13.99	8.51	BP18	ES18	69733	17.88	12.72	5.16	BP27	ES137
69586	23.5	15.62	7.88	S20	ES89	69749	21.92	13.06	8.86	S29	ES53
69587	15.9	10.64	5.26	ES19	ES56	69755	20.45	12.34	8.11	S1	ES185
69588						69756	20.45	12.34	8.11	S12	BP7
69589	17.54	11.53	6.01	ES19	ES59	69757	24.6	17.54	7.06	S1	ES85
69590	17.82	11.21	6.61	S58	ES59	69760	16.26	12.6	3.66	ES18	ES79
69591	17.73	11.72	6.01	ES185	ES185	69766	17.48	10.95	6.53	S36	EB21
69592	20.07	12.56	7.51	S1	ES107	69773	22.44	17.38	5.06	S33	ES69
69593	20.07	12.56	7.51	S1	ES107	69782	15.1	10.34	4.76	ES67	ES61
69594	19.42	12.41	7.01	EB1	ES34	69787	17.79	11.53	6.26	ES27	ES19
69595	20.34	12.83	7.51	EB1	ES34	69794	14.6	10.69	3.91	S36	BP14
69600	13.61	8.75	4.86	S1	BP30	69795	15.2	9.59	5.61	S12	ES110
69604	20.64	12.78	7.86	BP31	EB1	69805	18.19	11.93	6.26	ES71	ES71
69606	20.2	12.34	7.86	S1	EB1	69807	19.84	15.43	4.41	S28	ES3
69616	16.63	10.87	5.76	ES18	ES19	69808	22.74	13.63	9.11	ES84	ES84
69622	14.73	9.62	5.11	ES10	EB1	69811	13.6	9.69	3.91	S36	BP14
69624	21.7	12.84	8.86	BP14	S1	69813	24.26	14.15	10.11	S1	EB1
69625	14.11	9	5.11	S1	BP19	69820	19.1	11.84	7.26	S36	ES143
69632	21.78	13.42	8.36	ES84	ES84	69845	19.2	13.94	5.26	S36	ES143
69633	20.7	12.34	8.36	S1	ES91	69858	21.23	12.87	8.36	ES18	ES18
69645						69861	15.51	10.23	5.28	S39	ES28
69661	20.1	15.04	5.06	S36	ES137	69863	24.43	14.91	9.52	S27	ES18
69670	14.1	9.34	4.76	S1	EB1	69877	20.94	14.76	6.18	S26	ES3

ESPECIFICACIONES POR NÚMERO DE PARTE

AMORTIGUADORES ULTRA (CONTINUADO)

No. Parte Catálogo	Longitud Extendida	Longitud Comp.	Carrera	Montaje Superior	Montaje Inferior	No. Parte Catálogo	Longitud Extendida	Longitud Comp.	Carrera	Montaje Superior	Montaje Inferior
69878	20.94	14.76	6.18	S30	ES3	70020	21.89	13.14	8.75	S60	ES53
69880	21.1	12.84	8.26	S1	EB1	70023	21.81	15.94	5.87		
69881						70024	23.39	19.48	3.9		
69884	16.73	10.62	6.11	EB1	EB1	70027	17.82	12.95	4.88		
69885	17.63	11.37	6.26	ES43	ES43	70028	25.39	16.42	8.98		
69891	21.61	13.1	8.51	S12	ES10	70031	21.89	14.41	7.48		
69898	19.85	14.19	5.66	S1	ES185	70032	26.18	15.31	10.87		
69900	24.91	14.8	10.11	S1	ES67	70033	22.44	15.51	6.93		
69901	16.69	10.51	6.18	S52	ES143	70034	22.95	17.39	5.55		
69903	21.69	12.99	8.70	S27	ES18	70036	23.86	14.49	9.36		
69907	23.35	15.16	8.19	S50	ES113	70037	21.34	13.7	7.64		
69909	16.63	10.88	5.75	ES69	ES69	70038	23.11	15.67	7.44		
69924	20.74	13.48	7.26			70039	16.69	10.51	6.18		
69945	26.35	16.45	9.90	S19	ES84	70040	18.03	11.38	6.65		
69946	24.04	14.33	9.71	S25	ES6	70041	21.38	14.80	6.57		
69950	18.62	17.62	1.00	S30	ES3	70045	20.51	14.37	6.14		
69951	19.6	14.72	4.88	S30	ES3	70052	26.41	16.18	10.23		
69952	21.45	18.38	3.07	S33	ES3	70053	23.81	14.52	9.28		
69956	18.62	17.55	1.07	S30	ES3	70056	27.67	18.54	9.13		
69957	18.22	16.18	2.04	S30	ES3	70057	22.44	15.51	6.93		
69962	21.11	15.1	6.01	S36	U Bracket	70059	22.20	13.77	8.43		
69966	17.62	11.27	6.35	S33	ES3	70060	20.78	17.28	3.5		
69995	22.57	13.91	8.66			70061	22.24	14.09	8.14		
69996	19.1	15.04	4.06	S36	ES169	70063	22.13	14.57	7.56		
69998	17.91	14.09	3.82	S67	ES92	70064	20.31	15.24	5.08		
70000	19.57	12.09	7.48	S64	ES113	70065	19.80	12.76	7.05		
70001	22.52	13.94	8.58	BP34	ES72	70067	21.73	15.08	6.65		
70002	16.10	13.46	2.64			70068	22.51	14.88	7.63		
70003	26.55	18.62	7.93	S34	ES147	70073	23.70	15.12	8.58		
70004						70074	19.76	12.60	7.17		
70005	17.28	11.57	5.71			70077	15.12	12.01	3.11		
70006	19.29	12.28	7.01			70086	25.28	18.66	6.61		
70007	25.00	15.75	9.25			70087	12.71	8.95	3.76		
70009	15.08	10.24	4.84			70089	20.43	16.46	3.98		
70010	22.56	14.09	8.47	BP15	ES69	70095	15.28	10.04	5.24		
70011	23.66	15.00	8.66			70096	23.15	15.28	7.87		
70012	25.47	16.18	9.29			70098	15.04	10.47	4.57		
70013	22.95	14.88	8.07	S44	ES113	70103					
70014	23.66	14.49	9.17			70105					
70015	17.56	11.14	6.42			70110					
70019	15.51	10.12	5.39			70118					
						70162					

ESPECIFICACIONES POR NÚMERO DE PARTE

AMORTIGUADORES GUARDIAN HIDRÁULICOS REFORZADOS

No. Parte Catálogo	Longitud Extendida	Longitud Comp.	Carrera	Montaje Superior	Montaje Inferior
70159	15.35	10.44	4.91		
70160					
70161	12.6	8.59	4.01		
70163	20.23	12.82	7.41		
70164					
70165					
70166					
70167					

No. Parte Catálogo	Longitud Extendida	Longitud Comp.	Carrera	Montaje Superior	Montaje Inferior
70168					
70169					
70170					
70171					
70172					
70173					
70175					
70176					

AMORTIGUADORES MONOTUBO MAXCONTROL

No. Parte Catálogo	Longitud Extendida	Longitud Comp.	Carrera	Montaje Superior	Montaje Inferior
75676	19.66	11.83	7.83	S1	EB1
75755	20.34	12.59	7.75	S1	ES83
75795	15.24	9.66	5.58	S12	ES110
75811	13.55	9.67	3.88	S36	BP14
75898	19.85	14.18	5.67	S12	ES83
77183	20.86	13.01	7.85	EB1	EB1
77349	23.32	14.29	9.03	EB1	ES34
77355	14.85	9.86	4.99	EB1	ES24
77357	14.85	9.86	4.99	ES24	ES24
77359	13.55	8.84	4.71	S1	BP13
77375	14.14	9.04	5.10	S12	BP7
77377	19.87	12.23	7.64	EB1	ES25
77389	28.73	16.92	11.81	EB1	ES27
77403	24.31	14.78	9.53	ES26	ES26
77405	19.87	12.23	7.64	EB1	EB1
77406	22.92	13.9	9.02	EB1	ES83
77409	21.54	13.11	8.43	EB1	ES83
77410	18.47	11.71	6.76	S12	EB1
77412	26.77	16.26	10.51	ES34	ES34
77413	20.86	13.01	7.85	ES27	ES27
77414	15.33	10.34	4.99	S36	ES83
77418	14.14	9.04	5.10	S1	BP11
77421	13.55	8.84	4.71	S1	BP30
77422	23.92	14.39	9.53	BP14	ES34
77423	16.8	10.83	5.97	ES128	ES128
77424	20.34	12.59	7.75	S1	BP7
77425	19.87	12.23	7.64	EB1	BP20
77454	22.77	14	8.77	ES141	ES141
77455	22.92	13.9	9.02	ES83	ES83
77456	26.73	15.94	10.79	EB1	ES83
77461	25.39	15.18	10.21	EB1	ES83

No. Parte Catálogo	Longitud Extendida	Longitud Comp.	Carrera	Montaje Superior	Montaje Inferior
77479	14.14	9.04	5.10	S1	ES113
77488	26.77	16.26	10.51	BP14	ES34
77489	14.36	9.55	4.81	S29	BP11
77492	22.33	13.6	8.73	EB1	EB1
77494	21.78	13.52	8.26	EB2	EB2
77524	26.87	15.87	11.00	EB1	ES83
77525	22.9	14	8.90	EB1	ES83
77607	25.39	15.18	10.21	BP14	ES83
77608	14.45	9.64	4.81	S36	EB1
77609	16.43	10.95	5.48	ES126	ES128
77614	15.04	10.05	4.99	S36	EB1
77623	22.38	13.84	8.54	S38	ES83
77638	24.31	14.78	9.53	BP14	ES34
77660	24.9	14.88	10.02	EB1	EB1
77661	13.72	9.5	4.22	S12	ES34
77662	24.31	14.78	9.53	ES34	ES34
77673	22.38	13.84	8.54	S38	ES34
77674	23.27	14.27	9.00	S38	ES34
77675	26.25	15.74	10.51	ES34	ES34
77678	18.01	13.51	4.50	S36	BP7
77679	24.9	14.88	10.02	BP14	ES83
77683	21.11	13.27	7.84	EB5	ES24
77714	15.34	9.84	5.50	S38	BP7
77715	28.32	16.33	11.99	S12	ES171
77716	15.32	9.84	5.48	S38	ES26
77717	22.92	13.9	9.02	ES25	ES25
77726	20.85	13.05	7.80	S12	EB19
77772	14.51	9.72	4.79	S36	BP10
77778	24.38	14.36	10.02	S12	ES169
77781	18.57	11.8	6.77	S1	ES113
77782	14.14	9.04	5.10	S1	ES118

ESPECIFICACIONES POR NÚMERO DE PARTE

AMORTIGUADORES MONOTUBO MAXCONTROL (CONTINUADO)

No. Parte Catálogo	Longitud Extendida	Longitud Comp.	Carrera	Montaje Superior	Montaje Inferior
77783	14.64	10.12	4.52	S12	BP11
77803	15.31	10.32	4.99	S29	U Bracket
77807	15.33	10.34	4.99	S36	EB1
77808	28.73	16.92	11.81	EB1	ES83
77809	22.92	13.9	9.02	EB1	ES83
77810	31.53	18.5	13.03	EB1	ES83
77815	21.97	13.2	8.77	S47	ES64
77817	15.73	10.94	4.79	S12	ES60
77829	22.33	13.6	8.73	ES88	ES65
77837	28.73	16.92	11.81	ES83	BP14
77847	20.34	12.59	7.75	S1	BP7
77902	12.56	8.5	4.06	S1	ES64
77903	14.64	9.33	5.31	S1	BP14
77904	14.83	9.54	5.29	S1	ES64
77905	14.64	9.33	5.31	S1	ES83
77907	19.87	12.23	7.64	EB1	EB1
77909	14.14	9.04	5.10	S1	ES17
77915	13.61	8.85	4.76	S1	BP7
77937	14.93	9.35	5.58	S1	BP19
77947	15.63	10.88	4.75	S38	ES34

No. Parte Catálogo	Longitud Extendida	Longitud Comp.	Carrera	Montaje Superior	Montaje Inferior
77948	23.5	14.75	8.75	S38	ES34
77949	16.16	10.67	5.49	S38	BP27
77950	27.5	17.5	10.00	ES34	ES34
77951	20.5	13	7.50	S38	ES34
77952	29.68	17.43	12.25	EB1	ES185
77953	22.65	13.9	8.75	ES34	ES34
77954	13.83	9.08	4.75	S29	BP13
77955	22.57	13.91	8.66	S36	ES7
77958	14.51	9.35	5.16	S1	ES25
77967	20.75	13.13	7.62	S62	ES34
77968	24.71	15.09	9.62	EB1	ES185
77969	25.43	15.81	9.62	EB1	ES185
77975					
77976					
77978					
77979					
77980					
77981					
77983					

AMORTIGUADORES GUARDIAN

No. Parte Catálogo	Longitud Extendida	Longitud Comp.	Carrera	Montaje Superior	Montaje Inferior
81039	14.73	9.62	5.11	EB1	ES24
81076	14.2	9.44	4.76	BP4	DS1
81082	23.23	13.87	9.36	EB1	ES185
81091	25.14	15.28	9.86	ES27	EB4
81095	21.7	12.84	8.86	BP14	S1
81096	13.7	8.84	4.86	S1	BP13
81097	18.2	11.09	7.11	EB1	S1
81108	14.23	9.37	4.86	ES24	ES24
81113	18.23	11.37	6.86	ES31	ES24
81147	20.23	12.37	7.86	EB1	EB1
81153	11.61	7.75	3.86	S1	ES38
81164	23.23	13.87	9.36	EB1	ES34
81174	23.23	13.87	9.36	ES34	ES34
81242	19.2	11.59	7.61	S1	ES25
81270	17.67	10.56	7.11	S1	S1
81285	23.2	13.84	9.36	S1	ES25
81318	22.73	13.87	8.86	EB1	EB1
81322	15.51	10	5.51	S1	ES67

No. Parte Catálogo	Longitud Extendida	Longitud Comp.	Carrera	Montaje Superior	Montaje Inferior
81338	17.95	11.09	6.86	ES27	S12
81340	20.7	12.34	8.36	S1	EB1
81342	28.89	16.78	12.11	ES27	EB4
81394	17.47	11.21	6.26	S36	ES25
81406	10.67	7.06	3.61	S1	S12
81416	18.6	11.59	7.01	S9	EB1
81438	20.23	12.37	7.86	BP14	ES10
81440	24.6	14.59	10.01	S17	EB1
81445	13.46	9.95	3.51	ES86	ES34
81446	14.61	9.25	5.36	S1	BP7
81450	17.88	12.72	5.16	BP27	ES137
81459	21.73	13.37	8.36	ES84	ES84
81460	20.7	12.34	8.36	S1	ES91
81461	23.7	13.84	9.86	S1	ES185
81464	15.63	10.37	5.26	ES85	ES64
81469	22.54	13.68	8.86	EB4	EB4
81478	12.6	8.59	4.01	S1	ES64
81481	19.7	11.84	7.86	S1	EB1

ESPECIFICACIONES POR NÚMERO DE PARTE

AMORTIGUADORES GUARDIAN (CONTINUADO)

No. Parte Catálogo	Longitud Extendida	Longitud Comp.	Carrera	Montaje Superior	Montaje Inferior	No. Parte Catálogo	Longitud Extendida	Longitud Comp.	Carrera	Montaje Superior	Montaje Inferior
81482	24.23	14.37	9.86	BP14	ES34	81676	17.73	11.12	6.61	EB1	EB1
81484	20.23	12.37	7.86	EB1	ES25	81691	24.2	14.09	10.11	S1	ES25
81490	14.85	9.84	5.01	S12	ES41	81693	20.45	12.34	8.11	S12	BP7
81491	13	8.74	4.26	S12	DS1	81694	14.72	9.71	5.01	S36	ES25
81492	20.64	12.78	7.86	BP31	EB1	81710	21.73	13.12	8.61	EB1	ES185
81494	13.61	8.75	4.86	S1	BP30	81713	14.42	9.31	5.11	S29	BP7
81495	20.2	12.34	7.86	S1	EB1	81714	14.2	9.09	5.11	S1	BP7
81496	20.49	12.63	7.86	ES27	ES27	81726	16.48	10.87	5.61	ES126	ES128
81498	22.1	13.34	8.76	S17	EB1	81727	18.44	11.58	6.86	ES141	ES25
81501	21.6	14.44	7.16	S1	ES64	81730	23.23	13.87	9.36	EB1	ES185
81507	14.26	9.15	5.11	S1	ES64	81739	16.23	10.87	5.36	ES85	ES64
81508	21.6	13.34	8.26	S12	ES64	81741	18.31	13.64	4.67	ES69	ES4
81510	25.73	15.12	10.61	EB1	ES185	81742	22.6	13.59	9.01	S36	ES53
81514	22.14	13.28	8.86	BP31	EB1	81744	14.52	9.76	4.76	S36	EB1
81516	16.73	10.62	6.11	ES26	ES26	81750	13.61	8.75	4.86	S1	BP30
81517	21.12	16.31	4.81	S29	ES84	81789	23.73	14.12	9.61	BP14	ES34
81529	17.73	11.12	6.61	ES18	ES18	81790	18.92	11.56	7.36	S29	ES24
81530	21.92	13.06	8.86	S29	ES53	81791	15.2	9.59	5.61	S12	ES110
81538	24.23	14.37	9.86	EB1	EB1	81792	13.6	9.69	3.91	S36	BP14
81539	23.23	13.87	9.36	EB1	ES106	81793	22.78	13.67	9.11	ES84	ES84
81540	25.73	15.12	10.61	EB1	ES106	81794	19.85	14.19	5.66	S1	ES185
81541	14.7	9.34	5.36	S1	BP14	81795	19.2	13.94	5.26	S1	ES143
81542	20.1	12.34	7.76	S8	EB1	81821	23.23	13.87	9.36	ES41	ES41
81548	20.6	12.59	8.01	S1	BP7	81823	25.73	15.12	10.61	BP14	ES185
81549	20.73	12.62	8.11	BP20	EB1	81825	21.1	12.99	8.11	EB4	EB4
81553	15.2	9.59	5.61	S1	ES64	81826	15.6	10.09	5.51	S12	BP7
81554	18.48	11.62	6.86	ES64	EB1	81828	22.72	14.21	8.51	S36	ES185
81555	16.13	10.62	5.51	ES44	ES1	81833	20.21	12.45	7.76	S36	ES185
81557	16.29	10.93	5.36	ES64	ES112	81834	15.7	9.84	5.86	S1	BP13
81558	19.01	12.35	6.66	S1	ES109	81836	14.75	9.39	5.36	S1	ES83
81559	13.2	8.59	4.61	S1	BP7	81837	26.28	15.42	10.86	BP13	ES27
81560	23.14	13.78	9.36	BP13	ES27	81869	20.6	12.59	8.01	S1	BP7
81562	19.85	15.54	4.31	S36	ES74	81870	13.86	9	4.86	S1	ES113
81581	22.54	13.68	8.86	ES141	ES141	81871	22.04	13.43	8.61	EB2	EB2
81582	13.45	8.84	4.61	S1	BP4	81872	14.95	9.59	5.36	S1	ES64
81583	18.39	11.53	6.86	EB5	ES25	81873	24.74	14.88	9.86	ES34	ES34
81667	26.95	16.19	10.76	BP14	ES34	81878	17.73	11.12	6.61	ES18	ES18
81668	14.32	9.56	4.76	S29	BP11	81880	14.73	9.62	5.11	ES10	EB1
81670	11.7	7.84	3.86	S1	BP7	81881	19.1	11.84	7.26	S36	ES143
81671	23.35	15.44	7.91	S1	ES85	81882	15.63	10.37	5.26	ES69	ES69
81674	20.45	12.34	8.11	S1	ES185	81884					
81675	15.7	9.84	5.86	S1	EB1	81890	25.28	14.92	10.36	BP14	ES185

ESPECIFICACIONES POR NÚMERO DE PARTE

AMORTIGUADORES GUARDIAN (CONTINUADO)

No. Parte Catálogo	Longitud Extendida	Longitud Comp.	Carrera	Montaje Superior	Montaje Inferior	No. Parte Catálogo	Longitud Extendida	Longitud Comp.	Carrera	Montaje Superior	Montaje Inferior
81891	21.09	13.33	7.76	EB5	ES24	82001	15.98	10.37	5.61	ES64	ES64
81892	24.2	14.09	10.11	S12	ES171	82002	16.2	10.09	6.11	S17	ES14
81893	18.27	13.51	4.76	S36	BP7	82003	18.55	11.44	7.11	ES24	ES24
81894						82004	14.17	8.81	5.36	S17	S1
81896						82005	17.2	12.44	4.76	S1	ES64
81897						82006	20.48	12.62	7.86	ES24	ES24
81898						82007	18.23	11.37	6.86	EB1	EB1
81900						82010	16.63	12.47	4.16	ES34	ES34
81902	14.75	9.39	5.36	S1	ES76	82011	12.11	8	4.11	S1	ES11
81904	18.46	11.7	6.76	S1	ES185	82012	16.04	10.53	5.51	BP6	ES25
81905	26.97	15.86	11.11	EB1	ES185	82013	20.82	13.06	7.76	S29	BP20
81906	21.11	13.1	8.01	S12	EB19	82020	18.11	11	7.11	S8	ES62
81907	24.14	14.53	9.61	EB19	ES69	82025	12.95	9.19	3.76	S36	BP17
81908	14.75	9.34	5.41	S1	BP19	82026	13.42	8.56	4.86	S1	S1
81909	19.63	12.27	7.36	EB19	ES48	82030	20.23	12.37	7.86	ES43	ES43
81910	22.48	13.62	8.86	ES19	ES110	82031	16.23	10.37	5.86	ES18	ES18
81911	19.04	11.68	7.36	S1	ES153	82032	22.73	13.87	8.86	ES64	ES64
81912	15.48	9.87	5.61	S62	BP7	82033	18.79	12.03	6.76	ES25	EB19
81913	28.39	16.28	12.11	S12	ES171	82034	22.17	12.81	9.36	S1	S1
81914	15.48	9.87	5.61	S62	ES26	82035	14.64	9.53	5.11	ES24	EB1
81916	13.72	9.46	4.26	S36	BP10	82038	24.67	14.06	10.61	S1	S1
81917	23.03	13.92	9.11	EB1	ES185	82039	17.7	10.84	6.86	S1	EB1
81918	26.97	15.86	11.11	EB1	ES185	82040	21.7	12.84	8.86	S1	ES10
81919	22.3	13.54	8.76	S38	ES34	82046	26.04	15.43	10.61	EB4	EB4
81920	14.71	10.1	4.61	S12	BP11	82047	20.23	12.37	7.86	EB1	EB1
81921	26.76	15.67	11.09	ES34	ES34	82049	13.17	8.31	4.86	S1	S1
81922	15.35	10.24	5.11	S12	U Bracket	82051	22.14	13.28	8.86	BP8	EB1
81923	24.47	14.61	9.86	ES26	ES26	82054	24.54	14.68	9.86	EB4	EB4
81924	20.78	12.67	8.11	ES185	ES185	82060	23.23	13.87	9.36	EB1	EB1
81925	14.7	9.59	5.11	S12	ES7	82062	24.23	14.37	9.86	ES24	ES24
81926	21.25	13.24	8.01	ES88	ES65	82065	19.04	11.93	7.11	EB4	EB4
81927	21.01	15.87	5.14	S36		82066	22.7	13.34	9.36	S1	EB1
81928	13.78	9.52	4.26	S38	ES34	82067	20.86	12.5	8.36	S1	EB4
81929	19.49	12.13	7.36	BP20	ES24	82069	14.59	9.31	5.28	S1	S1
81930	22.81	13.95	8.86	ES34	ES34	82070	15.75	9.99	5.76	S1	DS1
81931	26.53	16.02	10.51	ES34	ES34	82072	11.61	7.75	3.86	S1	ES8
81932	15.87	10.51	5.36	S38	ES34	82074	18.7	11.34	7.36	S1	ES24
81933	13.97	9.11	4.86	S29	BP13	82075	16.1	10.34	5.76	S1	BP10
81934	26.14	16.45	9.69	S20	ES84	82076	18.7	11.34	7.36	ES66	S1
81935	24.19	15.93	8.26	S70	ES41	82079	15.54	9.93	5.61	ES9	BP20
81936	20.3	12.19	8.11	S12	BP11	82086	25.54	14.93	10.61	ES35	ES35
81937	21.44	13.18	8.26	S47	EB1	82087	14.61	9.25	5.36	S1	BP20

ESPECIFICACIONES POR NÚMERO DE PARTE

No. Parte Catálogo	Longitud Extendida	Longitud Comp.	Carrera	Montaje Superior	Montaje Inferior
82089	22.23	13.37	8.86	ES12	EB1
82090	16.11	10	6.11	S1	ES8
82093	21.23	12.87	8.36	BP31	ES10
82099	14.11	9	5.11	S1	BP19
82103	22.7	13.34	9.36	ES145	S1
82104	14.2	9.44	4.76	BP19	DS1
82109	13.64	8.74	4.90	S1	ES32
82110	14.1	8.99	5.11	S1	BP8
82118	15.31	10.06	5.25	S5	BP19
82123	18.6	11.59	7.01	S9	EB1
82124	22.1	13.34	8.76	S17	EB1
82125	20.67	12.06	8.61	S8	S1
82126	14.25	9.24	5.01	S36	DS1
82128	11.2	8.19	3.01	S36	ES40
82129	12.51	8.5	4.01	S1	BP3
82130	17.7	10.84	6.86	EB1	S36
82131	22.39	13.53	8.86	ES27	EB4

No. Parte Catálogo	Longitud Extendida	Longitud Comp.	Carrera	Montaje Superior	Montaje Inferior
82138	15.1	9.49	5.61	S1	BP3
82139	12.98	9.97	3.01	EB1	EB1
82147	23.23	13.87	9.36	EB1	ES25
82151	23.23	13.87	9.36	ES145	ES70
82155	20.7	12.34	8.36	S1	EB1
82156	20.23	12.37	7.86	EB1	EB1
82601	13.61	8.75	4.86	S1	ES16
82602	23.23	13.87	9.36	BP8	EB1
82603	17.7	10.84	6.86	S1	EB1
82607	14.73	9.62	5.11	EB1	EB1
82608	20.85	13.94	6.91	S12	ES39
82609	25.64	15.03	10.61	EB1	ES35
82610	23.23	13.87	9.36	EB1	EB1
82614	12.01	8.25	3.76	S12	ES5
82615	15.69	10.43	5.26	EB4	BP11
82617	18.86	11.5	7.36	S1	EB4
82618	25.73	15.12	10.61	BP14	EB1

CARTUCHOS DE STRUT ULTRA

No. Parte Catálogo	Longitud Extendida	Longitud Comp.	Carrera	Montaje Superior	Montaje Inferior
G244002	20.66	14.21	6.44		
G44450	22.17	14.55	7.62		
G44451	20.35	13.92	6.43		
G44459	20.32	13.41	6.91		
G44461	20.58	14.67	5.91		
G44477	24.98	16.77	8.21		
G44493	22.8	17.92	4.88		
G44495	20.74	14.65	6.09		
G44497	22.8	17.97	4.83		
G44713	26.08	18.74	7.34		
G44723					
G44724	22.68	14.95	7.73		
G44735	21.95	14.35	7.6		
G44743	19.70	13.10	6.6		
G44745	24.66	17.48	7.18		
G44747	19.46	13.57	5.89		
G44748	20.07	14.14	5.93		
G44752	24.22	17.81	6.41		
G44763	19.95	13.82	6.13		
G44766	23.9	16.12	7.78		

No. Parte Catálogo	Longitud Extendida	Longitud Comp.	Carrera	Montaje Superior	Montaje Inferior
G44767	21.04	14.21	6.84		
G44773	22.42	15.52	6.9		
G44774	21.36	14.13	7.23		
G44775	24.55	17.48	7.08		
G44776	24.66	16.77	7.90		
G44783	20.81	13.66	7.15		
G44800	21.05	15.24	5.82		
G44802	21.78	15.17	6.61		
G44803	21.01	14.38	6.63		
G44806					
G44850	22.3	15.42	6.88		
G44856	24.24	16.79	7.45		
G44862	22.98	16.78	6.2		
G44867	25.16	18.73	6.43		
G44868	23.14	17.33	5.82		
G44869	21.36	15.65	5.71		
G44898	23.87	16.14	7.73		
G44902	21.78	14.37	7.41		
G44903	19.81	13.59	6.22		
G44918	20.57	14.59	5.98		

ESPECIFICACIONES POR NÚMERO DE PARTE

CARTUCHOS DE STRUT ULTRA (CONTINUADO)

No. Parte Catálogo	Longitud Extendida	Longitud Comp.	Carrera	Montaje Superior	Montaje Inferior
G44920	25.22	18.02	7.2		
G44926	23.6	15.77	7.83		
G44934	21.90	15.20	6.71		
G44936	21.06	14.69	6.37		
G44937	22.68	16.53	6.16		
G44938	23.49	16.28	7.21		
G44939	19.72	13.66	6.07		
G44940	20.37	14.14	6.24		
G44941	25.17	18.67	6.5		
G44943	20.64	13.91	6.73		
G44944	19.18	13.29	5.90		
G44947	23.9	16.55	7.35		

No. Parte Catálogo	Longitud Extendida	Longitud Comp.	Carrera	Montaje Superior	Montaje Inferior
G44968	20.91	14.41	6.5		
G44969	25.61	18.00	7.61		
G44982	19.72	13.66	6.07		
G44986	21.45	14.95	6.5		
G44990	24.79	16.89	7.90		
G44991	25.24	18.24	7		
G44994	19.84	14.20	5.64		
G44995	18.77	13.21	5.56		
G44997	21.76	14.76	7		
G44998	20.17	13.86	6.31		
G44999	20.93	14.23	6.7		

ASIENTOS DE RESORTE ULTRA

No. Parte Catálogo	Longitud Extendida	Longitud Comp.	Carrera	Montaje Superior	Montaje Inferior
G51006	21.01	13.00	8.01		
G51007	21.87	13.86	8.01		
G51013	22.47	14.46	8.01		
G51017	23.31	14.55	8.76		
G51022	24.76	16.75	8.01		
G51027	20.17	12.41	7.76		
G51030	23.24	14.72	8.53		
G51031	22	14.50	7.5		
G51033	23.85	15.59	8.26		
G51034	19.31	12.41	6.91		
G51039	23.41	15.28	8.14		
G51046	22.48	15.22	7.26		
G51047	20.17	12.41	7.76		
G51060	21.81	14.44	7.37		
G51063	21.31	13.05	8.26		
G51064					
G51077	18.02	12.75	5.27		
G51078	20.79	13.69	7.1		
G51087	17.86	11.91	5.95		
G51097	22.83	18.07	4.76		
G51099	22.05	18.19	3.86		
G51100	23.62	15.9	7.72		
G511000					
G511001					
G511002					
G511003					

No. Parte Catálogo	Longitud Extendida	Longitud Comp.	Carrera	Montaje Superior	Montaje Inferior
G511004					
G51101	22.83	18.07	4.76		
G511019					
G511020					
G511021					
G511030					
G511031					
G511032					
G511037					
G511040					
G511041					
G511042					
G511043					
G511044					
G511057					
G511061					
G511062					
G511063					
G511066					
G511070					
G511072					
G511074					
G511076					
G511081					
G511102					
G511103					

ESPECIFICACIONES POR NÚMERO DE PARTE

ASIENTOS DE RESORTE ULTRA (CONTINUADO)

No. Parte Catálogo	Longitud Extendida	Longitud Comp.	Carrera	Montaje Superior	Montaje Inferior	No. Parte Catálogo	Longitud Extendida	Longitud Comp.	Carrera	Montaje Superior	Montaje Inferior
G511119						G51286	15.65	10.84	4.81		
G511122						G51290	19.78	13.07	6.71		
G511123						G51294					
G511124						G51295					
G511130						G51330	21.46	13.43	8.03		
G511140						G51346					
G511141						G51424	20.23	12.97	7.26		
G51161						G51477	18.14	13.36	4.78		
G51165	21.26	13.44	7.82			G51700	14.68	10.35	4.33		
G51170	19.31	12.41	6.9			G51703	20.6	16.65	3.95		
G51173	17.27	11.00	6.27			G51704	21.69	16.62	5.07		
G51180	18	12.00	6			G51705	23.28	14.49	8.78		
G51181	21.31	13.36	7.95			G51706	22.46	14.93	7.54		
G51182	16.13	10.33	5.8			G51709	20.44	15.32	5.12		
G51183	16.1	10.33	5.77			G51710	23.08	16.02	7.06		
G51184	16.85	10.70	6.15			G51711	17.25	14.75	2.5		
G51186	19.48	12.72	6.76			G51712	21.1	14.80	6.3		
G51188	24.21	14.38	9.83			G51713	22	15.69	6.31		
G51189	17.81	12.18	5.63			G51714	16.79	11.99	4.8		
G51190	21.38	15.35	6.03			G51715	14.92	10.43	4.49		
G51191	21.18	15.07	6.11			G51716	14.68	10.35	4.33		
G51192	24.21	14.38	9.84			G51718	16.61	11.41	5.2		
G51193	20.81	14.09	6.72			G51719	19.84	15.70	4.14		
G51195	18.12	13.42	4.70			G51720	21.05	16.14	4.91		
G51196	14.93	9.95	4.98			G51721	24.88	17.95	6.94		
G51197	20.37	15.76	4.61			G51722	18.93	16.73	2.2		
G51204	18.63	14.83	3.8			G51723	18.93	16.73	2.2		
G51216	23.23	15.35	7.88			G51724	19.28	13.69	5.59		
G51227	12.00	7.13	4.87			G51725	21.12	14.62	6.5		
G51229	21.23	14.97	6.26			G51727	17.62	12.87	4.75		
G51230	16.2	10.98	5.22			G51728	13.87	9.62	4.25		
G51232	21.73	14.97	6.76			G51729	21.5	14.26	7.24		
G51249	24.48	16.97	7.51			G51730	15.42	10.11	5.31		
G51252	18.82	12.02	6.8			G51731	22.56	15.1	7.46		
G51253	21.3	14.30	7			G51733	26.76	16.68	10.08		
G51254	21.3	14.30	7			G51735	21.93	14.41	7.52		
G51255	15.76	11.54	4.22			G51736	16.5	11.50	5		
G51256	22.66	15.45	7.22			G51737	17.12	12.50	4.62		
G51264	16.01	11.28	4.73			G51738	24.57	17.09	7.48		
G51267	14.25	10.70	3.55			G51739	21.36	16.79	4.57		
G51268	24.48	16.97	7.51			G51740	24.5	19	5.50	SS4	
G51279	16.37	11.07	5.3			G51742	22.12	17.37	4.75	S2	

ESPECIFICACIONES POR NÚMERO DE PARTE

ASIENTOS DE RESORTE ULTRA (CONTINUADO)

No. Parte Catálogo	Longitud Extendida	Longitud Comp.	Carrera	Montaje Superior	Montaje Inferior	No. Parte Catálogo	Longitud Extendida	Longitud Comp.	Carrera	Montaje Superior	Montaje Inferior
G51743	22	18.12	3.88	SS4		G51826	28.54	20.47	8.07		
G51744	19.75	15.5	4.25			G51827	16.61	10.67	5.94		
G51746	22.12	17.37	4.75	SS2		G51828	16.61	10.67	5.94		
G51747	23.51	14.91	8.61			G51829	24.88	15.75	9.13		
G51756	20.37	17.75	2.62			G51830	14.92	10.55	4.37		
G51757	17.37	13.12	4.25			G51831					
G51758	21.5	15.34	5.85	SS6		G51832	22.13	17.48	4.65		
G51759	23.25	15.12	8.12	SS2		G51833					
G51760	25.17	19.37	5.8	SS6		G51834					
G51761	25.17	19.37	5.8	SS6		G51835					
G51764	19.69	14.36	5.33			G51836	19.53	16.69	2.83		
G51765	15.56	10.99	4.01			G51837	19.21	13.39	5.83		
G51766	15.56	10.99	4.01			G51838	19.02	12.72	6.3		
G51767	18.19	12.36	5.83			G51839	18.58	13.34	5.24		
G51768	16.87	12.12	4.75			G51840					
G51769	21.61	17.67	3.94			G51841	20.98	14.29	6.69		
G51770	20.37	17.75	2.62			G51842	19.05	12.75	6.30		
G51771	18.12	13.12	5			G51847	24.8	17.04	7.76		
G51772	26	17.37	8.63	S4		G51848	21.41	13.66	7.75		
G51773	18	13.5	4.50			G51849	17.95	12.36	5.59		
G51774	16.73	11.88	4.85			G51850	16.1	11.06	5.04		
G51783	24.41	14.45	9.96			G51852	13.89	10.66	3.23		
G51794	17.28	11.06	6.22			G51853	16.85	12	4.84		
G51795	18.78	12.008	6.77			G51854	16.85	12	4.84		
G51796	14.25	10.71	3.54			G51855	23.26	17.55	5.7		
G51798	15.35	11.1	4.25			G51856	21.18	15.11	6.07		
G51799	23.03	14.65	8.38			G51857	18.62	12.24	6.38		
G51800						G51858	15.35	11.18	4.17		
G51801						G51859	18.5	14.29	4.21		
G51802	20.83	14.09	6.74			G51860	19.96	16.29	3.67		
G51803	14.41	10.12	4.29			G51861	19.21	15.15	4.05		
G51804	26.18	15.83	10.35			G51863	20.30	12.48	7.83		
G51805	27.13	16.61	10.52			G51864	21.57	17.16	4.41		
G51806	15.74	11.339	4.41			G51865	20.86	16.45	4.41		
G51807	21.93	17.48	4.45			G51868	17.56	13.35	4.21		
G51810	19.17	13.27	5.90			G51869	18.23	13.7	4.53		
G51811	19.17	13.27	5.90			G51870	21.22	15.43			
G51812	19.96	13.94	6.02			G51871	15.7	11.77	3.93		
G51813	23.98	19.21	4.77			G51874	20.43	16.41	4.01		
G51814	23.98	19.21	4.77			G51875	18.11	12.32	5.79		
G51815	18.07	13.46	4.61			G51876	18.11	12.32	5.79		
G51825	22.48	16.1	6.38			G51877	17.67	12.91	4.76		

ESPECIFICACIONES POR NÚMERO DE PARTE

ASIENTOS DE RESORTE ULTRA (CONTINUADO)

No. Parte Catálogo	Longitud Extendida	Longitud Comp.	Carrera	Montaje Superior	Montaje Inferior	No. Parte Catálogo	Longitud Extendida	Longitud Comp.	Carrera	Montaje Superior	Montaje Inferior
G51878	17.67	12.91	4.76			G51918	17.68	12.91	4.76		
G51879	15.67	10.94	4.73			G51919	23.31	15.79	7.52		
G51880	18.42	12	6.42			G51925					
G51881	16.57	11.65	4.92			G51926					
G51882	18.62	12.24	6.38			G51927					
G51883	19.52	12.48	7.04			G51928					
G51884	16.53	13.5	3.03			G51930					
G51885	24.44	15.39	9.05			G51933					
G51886	16.22	10.74	5.48			G51934					
G51887	15.55	12.08	3.47			G51935					
G51888	15.55	12.08	3.47			G51936					
G51889	19.29	12.91	6.38			G51937					
G51890	19.29	12.91	6.38			G51946					
G51891	17.8	13.54	4.26			G51947	24.96	19.29	5.67		
G51892	23	15.86	7.14			G51948	24.96	19.29	5.67		
G51894						G51949	18.27	14.49	3.78		
G51895						G51960					
G51896	18.54	14.09	4.45			G51961					
G51897	18.54	14.09	4.45			G51966					
G51898	16.57	12.09	4.49			G51969					
G51899	17.04	11.73	5.31			G51971					
G51900	22.83	14.92	7.91			G51972					
G51901	22.4	19.32	3.07			G51975					
G51904	16.22	11.5	4.72			G51976					
G51905	23.74	17.79	5.95			G51977					
G51906	20.07	14.49	5.59			G51982					
G51907	21.34	13.74	7.6			G51983					
G51908	17.44	11.3	6.14			G51984					
G51909	18.30	12.68	5.63			G51985					
G51911	18.86	15	3.86			G51989					
G51915	27.56	19.32	8.23			G51990					
G51916						G51993					
G51917	17.68	12.91	4.76			G51995					

ESPECIFICACIONES POR NÚMERO DE PARTE

STRUTS ULTRA

No. Parte Catálogo	Longitud Extendida	Longitud Comp.	Carrera	Montaje Superior	Montaje Inferior	No. Parte Catálogo	Longitud Extendida	Longitud Comp.	Carrera	Montaje Superior	Montaje Inferior
G35066	20.43	13.78	6.65			G52042	19.06	12.83	6.22		
G35098	18.35	12.46	5.89			G52043	21.85	14.53	7.32		
G52000	21.97	15.35	6.62			G52044	20.79	14.02	6.77		
G52001	21.97	15.35	6.62			G52045	20.79	14.02	6.77		
G52002	21.97	15.39	6.58			G52046	19.13	11.69	7.44		
G52003	21.97	15.39	6.58			G52047	19.13	11.69	7.44		
G52004	21.02	14.69	6.33			G52048	20.08	14.13	5.94		
G52005	19.02	11.81	7.21			G52052	18.94	13.35	5.59		
G52006	19.02	11.81	7.21			G52053	18.94	13.35	5.59		
G52007	21.02	14.69	6.33			G52055	18.82	12.76	6.06		
G52008	22.2	15.04	7.16			G52056	18.82	12.76	6.06		
G52009	22.2	15.04	7.16			G52057	18.11	13.31	4.8		
G52011	20	13.54	6.46			G52058	18.11	13.31	4.8		
G52013	20.52	13.5	7.02			G52061					
G52014	20.52	13.5	7.02			G52062					
G52015	18.86	13.35	5.51			G52063	18.43	12.52	5.91		
G52016	18.86	13.35	5.51			G52064	21.875	14.125	7.75		
G52017	21.77	13.9	7.87			G52065	22.72	15.39	7.32		
G52018	21.77	13.9	7.87			G52066	20.7	13.62	7.08		
G52019	19.17	12.64	6.53			G52069	20.39	15.12	5.28		
G52020	19.17	12.64	6.53			G52070	20.39	15.12	5.28		
G52021	21.42	13.66	7.76			G52071					
G52022	21.42	13.66	7.76			G52072					
G52023	19.84	13.54	6.30			G52073					
G52024	19.84	13.54	6.30			G52074					
G52025	19.61	13.15	6.46			G52075	19.32	12.56	6.77		
G52026	22.8	14.84	7.96			G52076	19.32	12.56	6.77		
G52027	22.8	14.84	7.96			G52077					
G52028	20.47	12.68	7.79			G52078					
G52029	20.47	13.07	7.40			G52079	18.54	12.44	6.10		
G52030	24.88	17.95	6.93			G52080	18.54	12.44	6.10		
G52031	24.88	17.95	6.93			G52081	22.83	16.3	6.53		
G52032	21.54	14.13	7.41			G52082	22.83	16.3	6.53		
G52033	21.54	14.13	7.41			G52083					
G52034	21.38	14.41	6.97			G52084					
G52035	21.38	14.41	6.97			G52085					
G52036	19.37	15.04	4.33			G52086					
G52037	19.37	15.04	4.33			G52087	20.68	14.625	6.06		
G52038	20.04	13.11	6.93			G52088	24.56	14.625	9.94		
G52039	20.04	13.11	6.93			G52089					
G52040	21.34	14.65	6.69			G52090					
G52041	21.46	15.16	6.30			G52094	17.28	13.03	4.25		

ESPECIFICACIONES POR NÚMERO DE PARTE

STRUTS ULTRA (CONTINUADO)

No. Parte Catálogo	Longitud Extendida	Longitud Comp.	Carrera	Montaje Superior	Montaje Inferior	No. Parte Catálogo	Longitud Extendida	Longitud Comp.	Carrera	Montaje Superior	Montaje Inferior
G52095	17.28	13.03	4.25			G52153	21.77	13.93	7.84		
G52096	20.7	13.42	7.28			G52154	19.29	12.52	6.77		
G52097	20.7	13.42	7.28			G52155	19.29	12.52	6.77		
G52098	20.6	13.85	6.75			G52156	19.84	12.59	7.25		
G52103	24.13	15.82	8.31			G52157	19.84	12.59	7.25		
G52104	24.13	15.82	8.31			G52158	23	15.94	7.06		
G52105	23.3	16.57	6.73			G52159	23	15.94	7.06		
G52106	23.3	16.57	6.73			G52160	19.68	13.15	6.53		
G52107	23.22	16.18	7.04			G52161	19.68	13.15	6.53		
G52108	23.22	16.18	7.04			G52162	22.2	14.13	8.07		
G52110	18.14	11.96	6.19			G52163	22.2	14.13	8.07		
G52111	18.14	11.96	6.19			G52164	16.25	10.78	5.47		
G52112	21.41	14	7.41			G52165	16.25	10.78	5.47		
G52113	21.41	14	7.41			G52166	21.22	13.81	7.41		
G52116	19.29	13.07	6.22			G52167	21.22	13.81	7.41		
G52117	21.69	14.76	6.93			G52168	21.61	14.17	7.44		
G52118	21.69	14.76	6.93			G52169	21.61	14.17	7.44		
G52121	17.51	13.3	4.21			G52170	20.9	16.02	4.88		
G52122	17.51	13.3	4.21			G52171	20.9	16.02	4.88		
G52123	22.01	14.84	7.17			G52172	20.66	16.32	4.33		
G52124	22.01	14.84	7.17			G52173	21.61	15.23	6.38		
G52125	22	14.13	7.87			G52174	21.61	15.23	6.38		
G52127	23.3	15.6	7.7			G52175					
G52128	23.3	15.6	7.7			G52176					
G52129	17.82	11.49	6.34			G52178	25	16.57	8.43		
G52130	17.82	11.49	6.34			G52179	25	16.57	8.43		
G52131	22.71	15.74	6.97			G52180	21.85	15.11	6.74		
G52136	17.63	11.57	6.06			G52181	21.85	15.11	6.74		
G52137	17.63	11.57	6.06			G52182	25.35	16.18	9.17		
G52138	16.96	11.02	5.94			G52183	25.35	16.18	9.17		
G52139	16.96	11.02	5.94			G52184	22.75	14.96	7.79		
G52140	24.13	16.97	7.16			G52185	22.75	14.96	7.79		
G52141	24.13	16.97	7.16			G52187	23.26	14.8	8.46		
G52142	18.38	14.05	4.33			G52188	23.26	14.8	8.46		
G52143	18.38	14.05	4.33			G52193	19.09	14.29	4.8		
G52144	20.35	15.39	4.96			G52194	19.09	14.29	4.8		
G52145	20.35	15.39	4.96			G52199	19.44	14.76	4.68		
G52148	22.12	14.76	7.36			G52200	19.44	14.76	4.68		
G52149	22.12	14.76	7.36			G52201	22.51	15.94	6.57		
G52150	24.68	16.69	7.99			G52202	22.51	15.94	6.57		
G52151	24.68	16.69	7.99			G52203	26.33	17.95	8.38		
G52152	21.77	13.93	7.84			G52204	26.33	17.95	8.38		

ESPECIFICACIONES POR NÚMERO DE PARTE

STRUTS ULTRA (CONTINUADO)

No. Parte Catálogo	Longitud Extendida	Longitud Comp.	Carrera	Montaje Superior	Montaje Inferior	No. Parte Catálogo	Longitud Extendida	Longitud Comp.	Carrera	Montaje Superior	Montaje Inferior
G52205	20.47	17.67	2.8			G52275	19.72	13.19	6.54		
G52206	19.21	13.18	6.03			G52276	18.30	11.3	7.01		
G52209	19.21	13.18	6.03			G52278	19.45	13.5	5.94		
G52210	25.7	17	8.69			G52279	19.45	13.5	5.94		
G52211	20.59	14.06	6.54			G52280	19.48	12.87	6.61		
G52213	20.08	14.21	5.87			G52281	19.48	12.87	6.61		
G52214	19.72	12.72	7.01			G52282	20.83	13.86	6.97		
G52215	19.72	12.72	7.01			G52283	20.83	13.86	6.97		
G52216	23.90	17.09	6.81			G52293					
G52217	20.08	14.21	5.87			G52294					
G52218	19.53	14.17	5.35			G52295					
G52220	23.66	16.02	7.64			G52297	16.46	11.14	5.31		
G52221	20.16	13.46	6.69			G52298	16.46	11.14	5.31		
G52222	20.16	13.46	6.69			G52299	20.63	15.12	5.51		
G52223	18.43	12.91	5.51			G52300	20.63	15.12	5.51		
G52224	18.43	12.91	5.51			G52301	20.24	14.69	5.55		
G52225	19.72	13.27	6.46			G52311					
G52226	19.72	13.27	6.46			G52312	18.27	13.35	4.92		
G52227	19.84	13.93	5.91			G52313	18.27	13.35	4.92		
G52228	19.84	13.93	5.91			G52314	20.98	16.34	4.65		
G52235						G52316	20.55	13.70	6.85		
G52236						G52329	20.75	13.50	7.24		
G52237	19.64	14.92	4.72			G52330	20.75	13.50	7.24		
G52238	19.64	14.92	4.72			G52331	19.49	12.72	6.77		
G52244	23.15	15.82	7.33			G52332	19.49	12.72	6.77		
G52245	20.51	13.39	7.13			G52335	21.46	14.06	7.4		
G52246	20.51	13.39	7.13			G52336	21.46	14.06	7.4		
G52249	23.03	16.85	6.18			G52339	21.22	14.96	6.26		
G52250	23.03	16.85	6.18			G52340	21.22	14.96	6.26		
G52253	25.35	16.57	8.77			G52341	17.99	10.83	7.17		
G52254	25.35	16.57	8.77			G52342	22.44	15.28	7.17		
G52255	20.04	13.23	6.81			G52344	20.24	14.09	6.14		
G52256	20.04	13.23	6.81			G52345	20.24	14.09	6.14		
G52257	23.5	15.59	7.91			G52346	18.86	13.31	5.55		
G52258	23.5	15.59	7.91			G52347	18.86	13.31	5.55		
G52260	25.31	17.28	8.02			G52348	26.38	21.54	4.84		
G52261	25.31	17.28	8.02			G52349	26.38	21.54	4.84		
G52262	21.61	13.7	7.91			G52351	24.13	16.69	7.44		
G52263	21.61	13.7	7.91			G52352	24.13	16.69	7.44		
G52272						G52353					
G52273						G52354					
G52274	19.72	13.19	6.54			G52355					

ESPECIFICACIONES POR NÚMERO DE PARTE

STRUTS ULTRA (CONTINUADO)

No. Parte Catálogo	Longitud Extendida	Longitud Comp.	Carrera	Montaje Superior	Montaje Inferior	No. Parte Catálogo	Longitud Extendida	Longitud Comp.	Carrera	Montaje Superior	Montaje Inferior
G52356						G52437					
G52359						G52438					
G52360	24.61	17.05	7.56			G52439					
G52361	24.61	17.05	7.56			G52440					
G52362						G52447					
G52363						G52448					
G52369						G52449					
G52370						G52450					
G52374						G52451					
G52375						G52452					
G52382						G52453	21.22	14.61	6.61		
G52383						G52454	21.22	14.61	6.61		
G52384						G52459					
G52385						G52460					
G52386						G52485					
G52387						G52486					
G52388						G52491					
G52389						G52492					
G52390						G52494	20.63	15.16	5.47		
G52395						G52495	20.63	15.16	5.47		
G52396						G52502					
G52398						G52503					
G52399						G52507					
G52400						G52508					
G52401						G52519					
G52406						G52520					
G52410						G52522					
G52411						G52523					
G52418						G52524					
G52419						G52525					
G52420						G52528					
G52421						G52529					
G52422						G52585					
G52423						G52586					
G52425						G52587					
G52426						G52588					
G52428						G52589					
G52429						G52591					
G52432	19.17	15.08	4.09			G52592					
G52433	19.17	15.08	4.09			G52594					
G52435						G52595					
G52436						G52600					

ESPECIFICACIONES POR NÚMERO DE PARTE

STRUTS ULTRA (CONTINUADO)

No. Parte Catálogo	Longitud Extendida	Longitud Comp.	Carrera	Montaje Superior	Montaje Inferior	No. Parte Catálogo	Longitud Extendida	Longitud Comp.	Carrera	Montaje Superior	Montaje Inferior
G52601						G55534	16.66	10.23	6.43		
G52622						G55539	18.02	11.95	6.07		
G52623						G55542	14.7	8.27	6.44		
G52624						G55544	16.66	10.26	6.4		
G52625						G55546	17.25	11.17	6.08		
G52638						G55551	24.1	14.50	9.6		
G52639						G55557	20	12.00	8		
G52665						G55561	16.38	9.84	6.54		
G52666						G55579	20.56	16.32	4.23		
G52698						G55580	20	12.50	7.5		
G52699						G55584	17.87	11.05	6.83		
G52725						G55586	16.32	9.67	6.65		
G52726						G55587	15.93	10.07	5.86		
G52727						G55588	20.8	13.05	7.75		
G52728						G55589	20.44	12.69	7.76		
G52742						G55590	19.41	13.04	6.37		
G52743						G55591	16.94	10.76	6.18		
G52837						G55592	15.96	9.54	6.42		
G52838						G55593	17.7	12.05	5.65		
G52855						G55594	17.7	12.05	5.65		
G52856						G55600	16.09	9.60	6.49		
G52886						G55601	20	12.50	7.5		
G52887						G55602	16.68	9.69	6.99		
G52888						G55603	22.49	14.15	8.34		
G52900						G55605	15.93	10.03	5.9		
G55505	16.98	10.40	6.58			G55606	19.95	12.47	7.48		
G55507	20.37	14.08	6.29			G55607	15.22	9.41	5.81		
G55509	19.36	13.35	6.01			G55608	15.22	9.41	5.81		
G55510	20.67	13.55	7.12			G55609	16.34	10.65	5.69		
G55511	17.89	11.85	6.05			G55610	16.17	10.90	5.27		
G55512	16.52	9.76	6.76			G55611	16.17	10.80	5.37		
G55514	16.98	10.40	6.58			G55615	16.26	11.06	5.2		
G55515	17.45	11.24	6.22			G55616	20.19	13.73	6.46		
G55516	20.39	13.41	6.99			G55652	18.73	12.25	6.49		
G55518	22.14	13.82	8.32			G55653	18.73	12.25	6.49		
G55521	17.37	11.06	6.31			G55657	17.23	10.93	6.3		
G55525	18.97	12.97	6.01			G55658	17.23	10.93	6.3		
G55526	17.41	10.83	6.58			G55661	19.57	11.76	7.81		
G55527	23.23	16.54	6.69			G55662	19.57	11.76	7.81		
G55529	20.03	12.50	7.53			G55663	17.34	11.26	6.09		
G55531	16.66	10.10	6.56			G55664	17.34	11.26	6.09		
G55533	20.94	13.65	7.29			G55665	24.78	16.33	8.45		

ESPECIFICACIONES POR NÚMERO DE PARTE

STRUTS ULTRA (CONTINUADO)

No. Parte Catálogo	Longitud Extendida	Longitud Comp.	Carrera	Montaje Superior	Montaje Inferior	No. Parte Catálogo	Longitud Extendida	Longitud Comp.	Carrera	Montaje Superior	Montaje Inferior
G55666	16.65	10.61	6.04			G55737	20.68	13.15	7.53		
G55667	16.65	10.61	6.04			G55738	20.68	13.15	7.53		
G55668	20.34	12.83	7.51			G55742	14.3	8.35	5.95		
G55669	20.34	12.83	7.51			G55743	14.35	8.36	5.99		
G55670	15.39	9.73	5.66			G55745	20.47	13.27	7.2		
G55671	15.39	9.73	5.66			G55746	20.31	11.56	8.75		
G55672	19.05	12.57	6.48			G55749	15.3	9.48	5.82		
G55673	16.82	11.05	5.77			G55752	22.75	14.63	8.12		
G55675	20.84	12.64	8.20			G55757	23.06	14.81	8.25		
G55676	20.84	12.64	8.2			G55763	15.56	9.88	5.68		
G55679	15.72	10.10	5.62			G55766	18.97	12.70	6.27		
G55680	17	12.25	4.75			G55769	24.35	15.03	9.32		
G55681	20.69	14.36	6.34			G55770	15.65	8.92	6.73		
G55685	20.01	13.49	6.52			G55771	18.99	13.42	5.58		
G55692	19.09	12.55	6.54			G55772	20.35	13.85	6.5		
G55693	24.59	15.59	9			G55773	15.84	10.03	5.81		
G55697	19.7	13.19	6.51			G55774	15.24	10.55	4.7		
G55698	19.92	13.14	6.78			G55776	27.1	16.30	10.8		
G55704	19.26	13.97	5.29			G55780	17.43	11.09	6.34		
G55705	19.01	12.00	7.01			G55781	16	10.50	5.5		
G55706	18.53	12.72	5.81			G55782	18.89	13.02	5.87		
G55707	20.11	14.24	5.87			G55784	21.25	14.00	7.25		
G55708	20.54	14.00	6.54			G55785	21.25	14.00	7.25		
G55710	16.67	9.7	6.97			G55786	24.75	16.50	8.25		
G55712	20.52	14.00	6.52			G55787	16	10.25	5.75		
G55713	17.79	11.43	6.36			G55788	20.28	14.69	5.59		
G55714	20.5	14.00	6.5			G55795	18.25	11.25	7		
G55715	19.42	13.5	5.92			G55796	24.75	16.50	8.25		
G55716	19.38	12.38	7			G55797	17.9	11.00	6.9		
G55719	18.2	11.36	6.84			G55800	19.63	12.38	7.25		
G55722	18.53	10.71	7.82			G55801	17.25	10.25	7		
G55723	13.84	8.52	5.32			G55802	15.31	10.37	4.94		
G55724	17.46	12.41	5.05			G55803	18.92	13.23	5.69		
G55725	16.58	10.7	5.88			G55804	18.55	12.05	6.49		
G55726	18.06	13.19	4.87			G55805	24.5	18.00	6.5		
G55727	17.87	10.23	7.63			G55817	20.25	12.56	7.7		
G55728	19.12	13.38	5.74			G55818	14.41	10.71	3.7		
G55729	22.78	14.16	8.62			G55819	18	13.40	4.6		
G55730	15.65	8.92	6.73			G55820	16	11.25	4.75		
G55731	18.21	10.38	7.83			G55821	23.3	15.95	7.35		
G55732	18.8	12.97	5.83			G55825	22.88	17.33	5.55		
G55733	21.61	13.82	7.79			G55828	19	13.00	6		

ESPECIFICACIONES POR NÚMERO DE PARTE

STRUTS ULTRA (CONTINUADO)

No. Parte Catálogo	Longitud Extendida	Longitud Comp.	Carrera	Montaje Superior	Montaje Inferior	No. Parte Catálogo	Longitud Extendida	Longitud Comp.	Carrera	Montaje Superior	Montaje Inferior
G55831	23.26	15.67	7.59			G55921	16.87	11.13	5.74		
G55832	16.61	10.61	6			G55923	20.75	13.74	7.01		
G55833	16.61	10.61	6			G55924	20.75	13.74	7.01		
G55834	16.77	10.05	6.72			G55925	20.63	14.21	6.42		
G55847	18.5	12.00	6.5			G55926	20.63	14.21	6.42		
G55848	20.16	11.87	8.30			G55927	21.38	12.82			
G55849	15.71	9.86	5.85			G55928	21.38	12.82			
G55850	15.71	9.86	5.85			G55929	22.99	15.12	7.87		
G55856	23.37	14.26	9.11			G55930	22.99	15.12	7.87		
G55857	18.14	11.57	6.57			G55931	22.47	14.00			
G55858	18.14	11.57	6.57			G55932	18.16	11.62	6.54		
G55859	21.52	12.02	9.5			G55933	21.75	14.00			
G55860	21.52	12.02	9.5			G55934	22.48	14.00	8.48		
G55865	21.7	15.63	6.08			G55945	16.20	10.36	5.84		
G55866	21.7	15.63	6.08			G55948	16.5	10.71	5.79		
G55867	22.96	14.95	8.01			G55949	23.13	16.09	7.05		
G55868	22.96	14.95	8.01			G55951	16.26	11.53	4.74		
G55870	16.78	11.56	5.22			G55952	25.06	16.11	8.95		
G55871	25.31	16.56	8.75			G55958	16.26	11.53	4.74		
G55877	15.24	10.55	4.7			G55960	19.51	13.60	5.91		
G55878	18.61	11.02	7.59			G55970	17.63	11.90	5.73		
G55879	16.51	10.28	6.23			G55971	17.63	11.90	5.73		
G55881	16.65	10.35	6.3			G55974	18.01	11.14	6.88		
G55882	16.65	10.35	6.3			G55975	20.97	12.80	8.18		
G55883	20.47	11.81	8.66			G55976	20.23	12.12	8.11		
G55884	20.47	11.81	8.66			G55977	20.23	12.12	8.11		
G55890	19.33	11.52	7.81			G55978	19.51	13.60	5.91		
G55891	15.53	9.78	5.75			G55989	18.49	11.34	7.15		
G55892	20.19	14.09	6.9			G55990	17.93	11.32	6.61		
G55893	24.41	16.46	7.95			G55991	20.87	14.53	6.34		
G55894	24.41	16.46	7.95			G55992	16.99	10.40	6.59		
G55896	20.2	14.1	6.10			G55993	21.73	15.16	6.57		
G55901	20.41	13.65	6.76			G55994	21.73	15.16	6.57		
G55903	13.88	7.84	6.04			G55999	16.79	10.81	5.98		
G55904	16.61	10.47	6.14			G56501	20.18	12.01	8.18		
G55909	15.32	10.38	4.95			G56502	17.22	10.54	6.68		
G55910	19.23	13.09	6.14			G56503	20.01	14.25	5.76		
G55911	16.22	9.72	6.5			G56504	20.37	13.14	7.24		
G55912	19.32	12.31	7.02			G56506	17.22	10.54	6.68		
G55913	19.32	12.31	7.02			G56508	17.52	10.66	6.87		
G55914	17.65	11.48	6.17			G56509	16.82	10.66	6.17		
G55920	16.87	11.13	5.74			G56512	20.5	13.75	6.75		

ESPECIFICACIONES POR NÚMERO DE PARTE

STRUTS ULTRA (CONTINUADO)

No. Parte Catálogo	Longitud Extendida	Longitud Comp.	Carrera	Montaje Superior	Montaje Inferior	No. Parte Catálogo	Longitud Extendida	Longitud Comp.	Carrera	Montaje Superior	Montaje Inferior
G56513	20.5	13.75	6.75			G56559	20.98	14.44	6.54		
G56514	17.22	10.54	6.68			G56561	23	16.37	6.62		
G56515	16.15	8.44	7.71			G56562	23	16.37	6.62		
G56516	20.22	14.02	6.2			G56565	16.77	11.81	4.96		
G56517	20.22	13.94	6.28			G56566	22.68	15.31	7.37		
G56518	15.23	8.83	6.41			G56568	25	17.75	7.25		
G56520	18.95	12.56	6.39			G56569	19.12	12.25	6.87		
G56522	16.41	9.98	6.43			G56570	19.12	12.25	6.87		
G56523	22.5	14.00	8.5			G56571	22.12	14.12	8		
G56524	22.25	14.00	8.25			G56572	20.55	13.66	6.89		
G56525	16.91	10.48	6.43			G56573	19.87	13.50	6.37		
G56526	16.91	10.48	6.43			G56574	23.5	16.00	7.5		
G56527	19.06	11.60	7.46			G56575	23.5	16.00	7.5		
G56528	19.06	11.60	7.46			G56576	19.87	13.50	6.37		
G56529	16.9	10.55	6.35			G56577					
G56530	16.9	10.55	6.35			G56579	25.5	17.12	8.37		
G56531	18.37	12.62	5.75			G56580	25.5	17.12	8.37		
G56532	18.37	12.62	5.75			G56581	20.74	13.59	7.15		
G56533	21.87	14.12	7.75			G56582	20.74	13.59	7.15		
G56534	21.87	14.12	7.75			G56585	19.25	12.87	6.37		
G56535	20.2	12.83	7.37			G56586	19.25	12.87	6.37		
G56536	23.39	15.00	8.39			G56587	16	11.75	4.25		
G56537	23.39	15.00	8.39			G56588	25.37	18.00	7.37		
G56538	23.39	15.00	8.39			G56589	25.37	18.00	7.37		
G56539	19.62	13.37	6.25			G56591	17.5	12.12	5.37	SS2	
G56540	19.62	13.37	6.25			G56592	20.75	15.75	5	SS2	
G56541	20.59	12.48	8.11			G56593	25.25	17.37	7.87		
G56542	20.59	12.48	8.11			G56594	20.03	15.23	4.8		
G56543	21.55	15.18	6.38			G56595	20.03	15.23	4.81		
G56544	21.55	15.18	6.38			G56596	18.25	13.50	4.75	SS2	
G56545	25.12	17.5	7.62			G56597	14.5	9.87	4.62		
G56546	25.12	17.5	7.62			G56598	19.74	15.23	4.51		
G56547	19.76	12.89	6.87			G56599	22.28	17.20	5.08		
G56548	19.76	12.89	6.87			G56600					
G56551	16.6	10.42	6.18			G56601	25	17.75	7.25		
G56552	16.6	10.42	6.18			G56602	24.06	16.93	7.13		
G56553	22.58	14.4	8.18			G56603	24.06	16.93	7.13		
G56554	22.58	14.4	8.18			G56604	20.71	15.98	4.73		
G56555	20.77	14.25	6.53			G56605	20.71	15.98	4.73		
G56556	20.77	14.25	6.53			G56606	19.65	13.23	6.42		
G56557	13.12	10.37	2.75			G56607	16.14	11.81	4.33		
G56558	20.98	14.44	6.54			G56608	17.13	12.2	4.93		

ESPECIFICACIONES POR NÚMERO DE PARTE

STRUTS ULTRA (CONTINUADO)

No. Parte Catálogo	Longitud Extendida	Longitud Comp.	Carrera	Montaje Superior	Montaje Inferior	No. Parte Catálogo	Longitud Extendida	Longitud Comp.	Carrera	Montaje Superior	Montaje Inferior
G56611	19.25	12.97	6.28			G56673	18.89	11.48	7.41		
G56612	20.39	14.21	6.18			G56674	18.89	11.48	7.41		
G56615	22.62	16.00	6.62			G56675	20.95	12.25	8.7		
G56616	22.62	16.00	6.62			G56676	20.95	12.25	8.7		
G56618	18.75	12.87	5.88			G56677	19.87	13.37	6.5		
G56619	18.75	12.87	5.88			G56678	19.87	13.37	6.5		
G56620	18.6	12.14	6.47			G56679	21.26	15.9	5.36	B2	
G56621	19.12	13.00	6.12			G56680	21.26	15.9	5.36	B2	
G56622	19.12	13.00	6.12			G56681	23.3	15.26	8.04		
G56624	25.37	18.00	7.37			G56682	23.3	15.26	8.04		
G56625	25.37	18.00	7.37			G56683	21.12	14.37	6.75	B10	
G56626	19.12	13	6.12			G56684	21.12	14.37	6.75	B10	
G56627	19.12	13	6.12			G56685	21.12	14.37	6.75	B11	
G56628	21.5	13.62	7.87	B2		G56686	21.12	14.37	6.75	B11	
G56629	21.5	13.62	7.87	B2		G56687	22.56	15.98	6.58		
G56631	20.74	13.59	7.15			G56688	22.56	15.98	6.58		
G56632	20.74	13.59	7.15			G56689	19.12	13.12	6		
G56633	20.08	12.52	7.56			G56690	19.12	13.12	6		
G56634	20.08	12.52	7.56			G56691	22.5	14.75	7.75		
G56635	16.6	10.42	6.18			G56692					
G56636	16.6	10.42	6.18			G56693					
G56637	22.12	14.12	8			G56694	18.78	11.06	7.72		
G56640	22.12	14.37	7.75			G56700	17.19	10.57	6.62		
G56641	22.12	14.37	7.75			G56701	18.49	11.34	7.15		
G56642	17.3	11.14	6.16			G56703	17.90	10.85	7.05		
G56643	17.3	11.14				G56704	17.73	11.07	6.66		
G56644	19.07	12.00	7.07			G56705	17.63	11.28	6.36		
G56645	19.07	12.00	7.07			G56706	17.63	11.28	6.36		
G56648	20.28	13.50	6.77			G56707	21.6	13.77	7.84		
G56649	20.63	13.98	6.65			G56708	18.77	10.85	7.92		
G56650	20.63	13.98	6.65			G56712	27.12	17.05	10.07		
G56655	20.03	13.38	6.65			G56713	18.01	10.76	7.25		
G56660	19.62	13.87	5.75			G56714	18.53	10.62	7.91		
G56661	19.62	13.87	5.75			G56715	17.84	9.98	7.87		
G56664	17.86	12.45	5.41			G56716	17.43	10.89	6.54		
G56667	20.81	13.23	7.58			G56717	17.9	10.86	7.05		
G56668	20.81	13.23	7.58			G56718	18.63	11.07	7.57		
G56669	17.65	10.57	7.09			G56719	20.04	13.26	6.78		
G56670	17.65	10.57	7.09			G56720	17.63	11.28	6.36		
G56671	20.5	13.62	6.87	B10		G56721	18.91	11.48	7.43		
G56672	20.5	13.61	6.87	B10		G56722	18.91	11.48	7.43		

ESPECIFICACIONES POR NÚMERO DE PARTE

STRUTS ULTRA (CONTINUADO)

No. Parte Catálogo	Longitud Extendida	Longitud Comp.	Carrera	Montaje Superior	Montaje Inferior	No. Parte Catálogo	Longitud Extendida	Longitud Comp.	Carrera	Montaje Superior	Montaje Inferior
G56723	17.63	11.28	6.36			G56781	19.37	14.00	5.37		
G56724	17.63	11.28	6.36			G56782	19.37	14.00	5.37		
G56728	20.95	12.25	8.7			G56784	20.25	14.25	6		
G56729	20.95	12.25	8.7			G56785	20.25	14.25	6		
G56730	23.72	16.95	6.77			G56786	13.37	8.50	4.87		
G56731	23.72	16.95	6.77			G56787	13.37	8.50	4.87		
G56732	22.91	15.41	7.50			G56790	18.5	12.87	5.62	B7	
G56733	22.91	15.41	7.50			G56791	20.25	16.12	4.13		
G56734	24.31	17.32	6.99			G56792	19.5	16.12	3.38		
G56735	24.31	17.32	6.99			G56793	19.13	13	6.13		
G56736	23.31	16.65	6.66			G56794	19.13	13	6.13		
G56739	23.31	16.65	6.66			G56795	20.62	14.75	5.87	B11	
G56740	16.56	10.41	6.15			G56796	20.67	14.21	6.46		
G56741	16.56	10.41	6.15			G56797	23.82	16.54	7.28		
G56742	19.17	12.36	6.81			G56798	23.54	16.34	7.2		
G56748	19.37	12.95	6.42			G56799	21.1	14.53	6.57	B17	
G56749	18.82	12.76	6.06			G56800	21.1	14.53	6.57	B17	
G56750	18.74	12.76	5.98			G56801	17.25	11.75	5.5	B2	
G56751	18.74	12.76	5.98			G56802	20.75	14.12	6.63	B11	
G56756	18.35	12.76	5.59			G56803	21.43	14.98	6.45	B16	
G56757	14.7	9.34	5.36			G56804					
G56758	21.75	14.50	7.25	B17		G56805	18.75	12.75	6.00	B10	
G56759	27.75	14.50	13.25			G56806	18.75	12.75	6.00	B10	
G56760	21.5	17.00	4.5			G56807	21	14.25	6.75		
G56761	21.5	17.00	4.5			G56809	19.75	13.12	6.62		
G56762	20.5	14.00	6.5	B9		G56810	20	13.50	6.5		
G56763	23.25	15.75	7.5			G56812	16.62	10.32	6.37		
G56764	23.25	15.75	7.5			G56813	21.73	15.75	5.98		
G56765	19.87	14.25	5.62			G56814	21.73	15.75	5.98		
G56766	19.87	14.25	5.62			G56817	16.59	10.9	5.69		
G56767	21.75	14.37	7.37	B9		G56819	21.35	15.18	6.16	B12	
G56768	21.75	14.37	7.37	B9		G56820	21.35	15.18	6.16	B12	
G56769	21.75	14.50	7.25			G56821	23.27	15.90	7.36		
G56770	22.25	17.12	5.12			G56822	23.27	15.90	7.36		
G56771	22.25	17.12	5.12			G56836	18.84	13.12	5.72		
G56772	20.8	13.38	7.42	B18		G56837	18.84	13.12	5.72		
G56773	20.94	12.87	8.07	B13		G56838	21.06	17.99	3.07		
G56774	20.94	12.87	8.07	B13		G56839	19.33	13.42	5.91		
G56775	16.98	9.9	7.08			G56840	20.51	13.63	6.88		
G56776	16.98	9.9	7.08			G56841	20.51	13.63	6.88		
G56778	21.37	14.37	7			G56842	19.47	13.41			

ESPECIFICACIONES POR NÚMERO DE PARTE

STRUTS ULTRA (CONTINUADO)

No. Parte Catálogo	Longitud Extendida	Longitud Comp.	Carrera	Montaje Superior	Montaje Inferior
G56843	19.47	13.41			
G56882	20.44	13.69	6.75		
G56883	20.44	13.69	6.75		
G56884	22.34	14.9	7.44		
G56885	22.34	14.9	7.44		
G56886	20.09	13.79	6.30		
G56887	20.09	13.79	6.30		
G56888	21.38	14.49	6.89		
G56889	21.38	14.49	6.89		
G56890	20.47	13.31	7.16		
G56891	20.47	13.31	7.16		
G56892	17.87	12.24	5.63		
G56893	17.87	12.24	5.63		

No. Parte Catálogo	Longitud Extendida	Longitud Comp.	Carrera	Montaje Superior	Montaje Inferior
G56894	20.98	14.29	6.69		
G56895	18.86	12.36	6.5		
G56896	18.86	12.36	6.5		
G56897	22.40	14.21	8.19		
G56898	22.40	14.21	8.19		
G56899	21.1	14.8	6.30		
G56903	21.92	15.19	6.74		
G56978	17.72	11.02	6.69		
G56979	17.72	11.02	6.69		
G56982	19.21	12.60	6.61		
G56983	19.21	12.60	6.61		
G56999	18.38	11.53	6.85		

AMORTIGUADORES PARA CAMIONETA ULTRA

No. Parte Catálogo	Longitud Extendida	Longitud Comp.	Carrera	Montaje Superior	Montaje Inferior
G63173	21.86	13.58	8.28	EB1	EB1
G63183	20.79	13.01	7.78	EB4	EB4
G63187	22.92	13.39	9.53	S1	S1
G63299	18.08	11.55	6.53	EB1	EB1
G63306	19.85	12.57	7.28	ES24	ES24
G63347	18.08	11.55	6.53	ES31	ES35
G63349	23.33	14.3	9.03	EB1	ES34
G63350	18.82	11.79	7.03	S1	ES25
G63353	24.74	14.96	9.78	ES27	EB4
G63355	14.98	9.95	5.03	EB1	ES24
G63357	14.98	9.95	5.03	ES24	ES24
G63359	13.7	8.92	4.78	S1	BP13
G63360	15.7	9.92	5.78	S1	BP13
G63366	23.26	14.23	9.03	ES34	ES34
G63371	21.98	13.45	8.53	ES24	ES24
G63375	14.14	9.11	5.03	S12	BP7
G63377	20.08	12.55	7.53	EB1	ES25
G63386	16.11	10.58	5.53	S36	ES25
G63387	23.32	14.04	9.28	S1	ES25
G63389	28.74	16.96	11.78	ES27	EB4
G63394	16.01	10.48	5.53	EB1	ES24
G63396	16.55	10.77	5.78	S12	ES25
G63398	20.42	12.14	8.28	S1	S1
G63403	24.58	14.8	9.78	ES26	ES26
G63404	17.05	11.02	6.03	S1	ES64

No. Parte Catálogo	Longitud Extendida	Longitud Comp.	Carrera	Montaje Superior	Montaje Inferior
G63405	20.01	12.48	7.53	EB1	EB1
G63406	22.98	13.95	9.03	EB1	ES185
G63409	21.48	13.2	8.28	EB1	ES185
G63410	18.55	11.77	6.78	S12	EB1
G63411	18.58	11.8	6.78	ES31	ES26
G63413	20.76	12.98	7.78	ES27	ES27
G63414	15.09	10.06	5.03	S36	ES41
G63416	18.55	11.77	6.78	S12	ES185
G63418	13.95	9.17	4.78	S1	BP11
G63419	24.08	14.55	9.53	EB1	EB1
G63420	27.08	16.05	11.03	EB1	ES106
G63421	13.7	8.92	4.78	S1	BP30
G63422	24.01	14.48	9.53	BP14	ES34
G63423	16.76	10.73	6.03	ES26	ES26
G63424	20.45	12.67	7.78	S1	BP7
G63425	20.01	12.48	7.53	BP20	EB1
G63426	18.01	11.48	6.53	ES18	ES18
G63427	22.98	13.95	9.03	EB1	ES106
G63432	21.11	12.83	8.28	S1	EB19
G63434	22.68	13.9	8.78	EB19	S32
G63437	23.33	14.05	9.28	ES31	ES24
G63438	29.33	17.3	12.03	EB1	ES34
G63439	29.76	17.23	12.53	EB1	ES185
G63440	26.33	15.55	10.78	EB1	EB1
G63441	26.33	15.55	10.78	EB1	ES25

ESPECIFICACIONES POR NÚMERO DE PARTE

AMORTIGUADORES PARA CAMIONETA ULTRA (CONTINUADO)

No. Parte Catálogo	Longitud Extendida	Longitud Comp.	Carrera	Montaje Superior	Montaje Inferior	No. Parte Catálogo	Longitud Extendida	Longitud Comp.	Carrera	Montaje Superior	Montaje Inferior
G63443	23.33	13.95	9.38	EB1	EB1	G63616	23.78	14.25	9.53	S38	EB19
G63444	23.3	14.02	9.28	S1	ES64	G63617	27.58	16.3	11.28	ES83	EB1
G63445	23.09	14.06	9.03	S36	ES185	G63620	19.55	12.27	7.28	EB1	S17
G63446	23.3	14.02	9.28	S12	EB1	G63621	16.46	10.93	5.53	S12	BP7
G63447	30.18	17.65	12.53	S12	ES25	G63622	15.32	10.29	5.03	S36	EB1
G63454	22.79	14.01	8.78	ES141	ES141	G63623	22.57	14.29	8.28	S36	ES185
G63455	22.98	13.95	9.03	ES41	ES41	G63624	20.17	12.64	7.53	S36	ES185
G63456	26.85	16.07	10.78	EB1	ES185	G63625	22.56	13.78	8.78	EB1	ES24
G63457	13.7	8.92	4.78	S1	BP4	G63626	21.14	13.36	7.78	EB5	ES24
G63460	23.16	14.13	9.03	BP13	ES27	G63635	14.45	9.42	5.03	S1	ES69
G63461	25.51	15.23	10.28	EB1	ES41	G63638	24.33	14.8	9.53	BP14	ES34
G63479	13.95	9.17	4.78	S1	ES113	G63639	24.16	14.63	9.53	EB19	ES69
G63484	20.05	12.52	7.53	S8	EB1	G63640	23.89	15.11	8.78	ES152	ES153
G63488	26.61	16.33	10.28	BP14	ES34	G63660	25.08	15.05	10.03	EB1	EB1
G63489	14.42	9.64	4.78	S29	BP11	G63661	13.8	9.52	4.28	S38	ES34
G63490	19.08	12.05	7.03	EB1	ES25	G63662	24.58	15.05	9.53	ES34	ES34
G63491	19.05	11.77	7.28	EB1	S1	G63671	22.48	13.7	8.78	ES26	ES26
G63492	22.58	13.8	8.78	EB1	EB1	G63673	22.3	13.77	8.53	S38	ES34
G63494	22.39	13.86	8.53	EB19	EB19	G63674	23.39	14.36	9.03	S38	ES34
G63495	14.95	9.67	5.28	S1	ES64	G63675	26.86	16.08	10.78	ES34	ES34
G63499	25.58	15.3	10.28	BP13	ES26	G63676	15.48	10.45	5.03	ES69	ES69
G63500	15.09	10.06	5.03	S36	ES25	G63678	18.09	13.56	4.53	S36	BP7
G63502	18.51	11.98	6.53	ES25	ES141	G63679	25.01	14.98	10.03	BP14	ES185
G63506	21.4	12.64	8.76	S32	S32	G63683	21.14	13.36	7.78	EB5	ES24
G63510	21.29	13.26	8.03	EB19	EB19	G63689	19.08	12.05	7.03	EB1	EB1
G63511	22.45	13.42	9.03	S1	ES25	G63690	18.01	11.48	6.53	ES18	ES18
G63524	27.08	16.05	11.03	EB1	ES185	G63692	27.58	16.3	11.28	EB1	EB1
G63525	22.98	13.95	9.03	EB1	ES185	G63694	22.18	13.4	8.78	S38	EB20
G63547	13.61	9.08	4.53	S1	ES113	G63707	15.89	10.11	5.78	S12	ES64
G63548	21.11	13.08	8.03	S12	EB19	G63708	19.74	12.46	7.28	ES48	EB19
G63603	16.12	10.59	5.53	S36	ES185	G63710	18.96	11.93	7.03	S1	ES153
G63604	19.74	12.46	7.28	EB1	ES142	G63712	22.48	13.7	8.78	ES110	ES19
G63605	24.24	14.71	9.53	EB19	ES27	G63714	15.39	9.86	5.53	S62	BP7
G63606	21.29	13.51	7.78	ES152	ES153	G63715	28.55	16.52	12.03	S12	ES171
G63607	25.58	15.3	10.28	BP14	ES185	G63716	16.39	9.86	6.53	S62	ES26
G63608	14.56	9.78	4.78	S36	EB1	G63717	22.98	13.95	9.03	ES41	ES41
G63609	16.5	10.97	5.53	ES126	ES128	G63720	21.39	12.86	8.53	S36	ES22
G63610	21.95	13.17	8.78	S47	EB1	G63721	20.21	12.43	7.78	S12	BP11
G63611	14.95	9.67	5.28	S1	ES64	G63722	19.49	12.21	7.28	BP20	ES24
G63612	14.45	9.67	4.78	S1	ES64	G63726	21.05	12.77	8.28	S12	EB19
G63614	15.09	10.06	5.03	S36	EB1	G63772	13.73	9.45	4.28	S36	BP10
G63615	23.66	13.88	9.78	S38	S38	G63773	22.98	13.95	9.03	EB1	ES185

ESPECIFICACIONES POR NÚMERO DE PARTE

AMORTIGUADORES PARA CAMIONETA ULTRA (CONTINUADO)

No. Parte Catálogo	Longitud Extendida	Longitud Comp.	Carrera	Montaje Superior	Montaje Inferior	No. Parte Catálogo	Longitud Extendida	Longitud Comp.	Carrera	Montaje Superior	Montaje Inferior
G63775	27.08	16.05	11.03	EB1	ES185	G63879	23	14.31	8.69	BP10	ES34
G63776	20.76	12.98	7.78	ES185	ES185	G63880	22.5	14.06	8.44	BP18	ES18
G63778	24.55	14.52	10.03	S12	ES171	G63881	14.71	9.49	5.22	S1	ES25
G63781	18.45	11.93	6.52	S1	ES113	G63882	21	13.31	7.69	BP10	ES34
G63782	13.7	9.09	4.61	S1	ES118	G63883	22.82	14.38	8.44	ES34	ES13
G63783	14.59	10.21	4.38	S12	BP11	G63884	14.72	9.78	4.94	S47	EB13
G63798	15.98	10.2	5.78	S1	EB1	G63885	22.24	13.56	8.68	S59	ES36
G63799	18.55	11.77	6.78	S1	ES185	G63886	20.8	13.36	7.44	S38	ES34
G63803	15.36	10.33	5.03	S12	U Bracket	G63887	29.71	17.77	11.94	EB1	ES41
G63808	28.86	17.08	11.78	EB1	ES185	G63888	31.36	18.67	12.69	EB1	ES41
G63809	22.98	13.95	9.03	EB1	ES185	G63889	20.44	12.75	7.69	S1	ES81
G63810	31.6	18.57	13.03	EB1	ES185	G63890	23.97	15.28	8.69	ES87	ES87
G63811	25.51	15.23	10.28	EB1	ES41	G63891	23.97	15.28	8.69	ES87	ES87
G63812	22.56	13.78	8.78	ES86	ES36	G63892	23.97	15.28	8.69	ES19	ES87
G63813	12.23	8.45	3.78	S47	ES64	G63893	15.07	10.44	4.63	S11	U Bracket
G63815	21.95	13.17	8.78	S47	ES64	G63894	12.82	8.88	3.94	S11	BP9
G63817	15.8	11.02	4.78	S12	ES60	G63895	14.12	9.68	4.44	S11	BP9
G63818	16.51	10.98	5.53	ES126	ES128	G63896	22.36	13.92	8.44	BP14	ES34
G63828	23.16	15.13	8.03	S21	EB20	G63897	23.87	14.68	9.19	BP14	ES34
G63829	22.52	13.74	8.78	ES88	ES65	G63898	25.19	15.31	9.88	BP14	ES34
G63832	17.16	11.38	5.78	S21	ES153	G63900	14.1	9.34	4.76	S1	BP4
G63837	28.23	17.95	10.28	BP8	ES41	G63902	12.6	8.59	4.01	S1	ES64
G63841	16.58	11.05	5.5			G63903	14.7	9.34	5.36	S1	BP14
G63842	23.33	14.8	8.53	ES18	ES126	G63904	14.95	9.95	5.00	S1	ES64
G63844	22.52	13.74	8.78	ES87	ES19	G63905	14.7	9.34	5.36	S1	ES76
G63845	24.58	14.8	9.78	ES87	ES19	G63906	20.49	12.63	7.86	ES27	ES27
G63847	20.45	12.67	7.78	S1	BP7	G63907	20.23	12.37	7.86	EB1	EB1
G63848	15.87	10.59	5.28	S38	ES34	G63908	18.23	11.37	6.86	ES31	ES24
G63860	24.33	14.39	9.94	S1	EB1	G63909	14.11	9	5.11	S1	ES64
G63862	25.07	14.94	10.13	S1	ES67	G63914	21.12	16.31	4.81	S29	ES84
G63864	15	10.56	4.44	ES67	ES61	G63915	13.2	8.59	4.61	S1	BP7
G63866	22.81	14.12	8.69	ES34	ES34	G63918	21.25	13.56	7.69	ES34	ES141
G63867	27.31	16.37	10.94	ES82	ES82	G63919	21.25	13.56	7.69	ES58	ES153
G63868	15.61	10.67	4.94	ES164	ES68	G63928	22.73	13.87	8.86	EB1	EB1
G63869	20.26	12.82	7.44	ES41	ES41	G63929	14.72	9.71	5.01	S36	EB1
G63870	24.89	15.2	9.69	ES82	ES82	G63937	14.7	9.34	5.36	S1	BP19
G63872	21.65	13.29	8.36	ES128	ES128	G63949	17.73	11.12	6.61	EB1	EB1
G63873	15.75	10.56	5.19	ES82	ES82	G63950	14.2	9.09	5.11	S1	BP7
G63875	17.67	11.73	5.94	ES13	ES13	G63958	13.8	9.13	4.67	S29	BP13
G63877	16.93	11.24	5.69	ES69	ES69	G63959	24.78	15.84	8.94	ES34	ES34
G63878	24.16	14.97	9.19	ES34	ES13	G63961	26.51	16.12	10.39	ES34	ES34

ESPECIFICACIONES POR NÚMERO DE PARTE

AMORTIGUADORES PARA CAMIONETA ULTRA (CONTINUADO)

No. Parte Catálogo	Longitud Extendida	Longitud Comp.	Carrera	Montaje Superior	Montaje Inferior	No. Parte Catálogo	Longitud Extendida	Longitud Comp.	Carrera	Montaje Superior	Montaje Inferior
G63962	26.05	15.87	10.18	ES34	ES34	G64048	17.16	11.57	5.59	ES75	ES113
G63963	24.75	15.06	9.69	EB1	ES185	G64049	14.96	11.65	3.31	S51	ES55
G63964	25.48	15.53	9.95	EB1	ES185	G64050	19.55	12.91	6.65	ES30	ES137
G63965	24.14	15.2	8.94	BP14	ES34	G64052	20.86	13.11	7.75	ES83	ES83
G63966	22.45	14.5	7.95	BP18	ES26	G64056	20.51	13.11	7.4	S18	ES83
G63967	22.62	14.43	8.19	BP18	ES26	G64057	22.52	13.98	8.54		
G63969	20.75	13.31	7.44	S62	ES34	G64058	14.53	9.25	5.28		
G63970	27.58	17.14	10.44	ES34	ES34	G64059	22.09	15.51	6.57		
G63971	27.58	17.14	10.44	ES34	ES34	G64060	25.55	17.01	8.54		
G64000	27.36	17.68	9.68	ES34	ES34	G64061	19.02	12.52	6.50		
G64001	14.67	11.47	3.20	S11	U Bracket	G64062	25.59	17.01	8.58		
G64002	20.15	13.96	6.19	ES83	ES83	G64063	19.17	13.27	5.91		
G64003	16.84	11.28	5.56	ES69	ES69	G64064	16.69	10.83	5.87		
G64004	19.07	12.13	6.94	S1	ES81	G64071	18.66	12.13	6.54		
G64005	19.75	12.31	7.44	S1	ES81	G64072	25.75	15.47	10.28		
G64006	22.75	13.81	8.94	S1	ES81	G64074	23.74	17.09	6.65		
G64007	22.75	13.81	8.94	S1	ES81	G64079	29.37	17.32	12.05	ES83	ES83
G64008	21.79	13.6	8.19	S57	ES26	G64080	21.57	17.72	3.85	ES69	ES33
G64009	23.29	14.25	9.04	S38	ES34	G64083	17.64	11.38	6.26		
G64010	26.94	16	10.94	EB1	ES83	G64084	14.41	9.09	5.31		
G64011	23.36	14.21	9.15	S62	ES87	G64085	21.89	13.39	8.50		
G64012	24.11	15.17	8.94	ES88	ES69	G64087	22.63	13.78	8.85		
G64013	26.52	16.33	10.19	ES34	ES34	G64090	18.54	12.36	6.18		
G64014	22.75	14.56	8.19	ES47	ES45	G64105	19.69	12.05	7.64		
G64015	21.32	13.63	7.69	ES45	ES128	G64107					
G64016	15.91	11.22	4.69	ES19	ES17	G64111					
G64026	16.26	11.57	4.69	ES73	ES73	G64114					
G64027	13.62	8.74	4.88	S47	ES118	G64121	25.36	16.17	9.19		
G64028	20.75	13.19	7.56	EB16	ES113	G64128	21.18	13.24	7.94		
G64029	21.73	13.54	8.19	S38	ES36	G64129	13.94	9.25	4.69		
G64030	22.56	13.86	8.70	S38	ES36	G64130	19.33	12.49	6.84		
G64031	21.19	13.5	7.69	ES34	EB1	G64131	24.21	15.03	9.19		
G64032	18.7	12.09	6.61	ES49	ES49	G64140					
G64033	14.72	10.36	4.36	ES51	ES51	G64143					
G64036	22.67	13.66	9.01	S45	ES51	G64144					
G64037	26.37	15.47	10.9	S55	ES147	G64146					
G64038	24.48	15.07	9.41	S63	ES69	G64154					
G64040	15.9	11.1	4.8	ES42	ES50	G64157					
G64042	14.92	10.55	4.37	ES18	ES18	G64163					
G64043	14.09	9.68	4.41	S61		G64164					
G64044	25.98	16.22	9.76	ES49	ES49	G64181					
G64046	18.62	14.72	3.9	S65	ES93	G64182					
G64047	25.03	15	10.03			G64184					
						G64185					

EXPLICACIÓN DE LOS DATOS

Número de Parte:	El número de catálogo para cada amortiguador.
Longitud Extendida*:	La longitud del amortiguador cuando está completamente extendido. Consulte las instrucciones de "Cómo Medir".
Longitud Comprimida*:	La longitud del amortiguador cuando está totalmente colapsado. Consulte las instrucciones de "Cómo Medir".
Carrera:	Esta es la longitud aproximada de la distancia que recorre el amortiguador descrito.
Códigos de Montaje:	Indica el tipo de montaje para el extremo superior e inferior de cada amortiguador. Se enlistan como sigue: Montajes Tipo Espiga ("S" y "DS") Montajes anillo y buje ("EB") Montajes anillo y buje con camisa de acero ("CB" y "ES") Montaje Anillo Perno Tubular o Corbata ("BP") Montaje especiales ("SP")

*** NOTA: TODAS LAS DIMENSIONES ESTÁN EN PULGADAS - VER TABLAS DE CONVERSIÓN ABAJO.**

TABLA DE CONVERSIÓN

Fracción (Pulgadas)	Decimal (Pulgadas)	Métrico (Milímetros)	Fracción (Pulgadas)	Decimal (Pulgadas)	Métrico (Milímetros)
1/64	0.016	0.397	33/64	0.516	13.097
1/32	0.031	0.794	17/32	0.531	13.494
3/64	0.047	1.191	35/64	0.547	13.891
1/16	0.063	1.588	9/16	0.563	14.288
5/64	0.078	1.984	37/64	0.578	14.684
3/32	0.094	2.381	19/32	0.594	15.081
7/64	0.109	2.778	39/64	0.609	15.478
1/8	0.125	3.175	5/8	0.625	15.875
9/64	0.141	3.572	41/64	0.641	16.272
5/32	0.156	3.969	21/32	0.656	16.669
11/64	0.172	4.366	43/64	0.672	17.066
3/16	0.188	4.763	11/16	0.688	17.463
13/64	0.203	5.159	45/64	0.703	17.859
7/32	0.219	5.556	23/32	0.719	18.256
15/64	0.234	5.953	47/64	0.734	18.653
1/4	0.250	6.350	3/4	0.750	19.050
17/64	0.266	6.747	49/64	0.766	19.447
9/32	0.281	7.144	25/32	0.781	19.844
19/64	0.297	7.541	51/64	0.797	20.241
5/16	0.313	7.938	13/16	0.813	20.638
21/64	0.328	8.334	53/64	0.828	21.034
11/32	0.344	8.731	27/32	0.844	21.431
23/64	0.359	9.128	55/64	0.859	21.828
3/8	0.375	9.525	7/8	0.875	22.225
25/64	0.391	9.922	57/64	0.891	22.622
13/32	0.406	10.319	29/32	0.906	23.019
27/64	0.422	10.716	59/64	0.922	23.416
7/16	0.438	11.113	15/16	0.938	23.813
29/64	0.453	11.509	61/64	0.953	24.209
15/32	0.469	11.906	31/32	0.969	24.606
31/64	0.484	12.303	63/64	0.984	25.003
1/2	0.500	12.700	1	1.000	25.400

TABLA DE CONVERSIÓN MÉTRICA

Milímetros	Pulgadas	Milímetros	Pulgadas	Milímetros	Pulgadas
1	0.03937	10	0.39370	19	0.74803
2	0.07874	11	0.43307	20	0.78740
3	0.11811	12	0.47244	21	0.82677
4	0.15748	13	0.51181	22	0.86614
5	0.19685	14	0.55118	23	0.90551
6	0.23622	15	0.59055	24	0.94488
7	0.27559	16	0.62992	25	0.98425
8	0.31496	17	0.66929		
9	0.35433	18	0.70866		

CÓMO MEDIR LAS LONGITUDES EXTENDIDAS Y COMPRIMIDAS EN LOS AMORTIGUADORES DE AUTOS Y CAMIONETAS

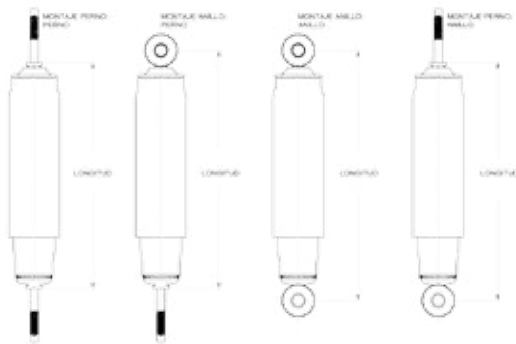

Instrucciones:

1. Use los puntos de medición mostrados en las figuras y busque en la lista de longitudes extendidas y comprimidas para encontrar el amortiguador que más se aproxima al que busca.
2. Identifique el montaje apropiado de las tablas de códigos de montaje y verifique si la pieza física tiene las mismas medidas en los montajes superior e inferior contra las que aparecen en las tablas.
3. Adicionalmente tome nota de los siguientes elementos que podrían interferir en la selección de un reemplazo:
 - a. **Accesorios de montaje:** Contenidos y descripciones de partes están mostrados en este manual.
 - b. **Tubos polvera:** Este requisito debe tenerse en cuenta en comparación con el amortiguador que será reemplazado. El ambiente del amortiguador en esta aplicación hace de éste un requisito necesario para protección de la barra y para extender la vida útil del producto.
 - c. **Resorte o topes de compresión internos:** Tome en cuenta en estas especificaciones que la desviación de la longitud no debe exceder de $\pm 1/2$ ". Estos diseños están citados en los pies de página para una fácil identificación.
 - d. **Aplicación para el Medio Ambiente limitada** - La mayoría de los amortiguadores convencionales se ofrecen con una construcción "recta" para adaptarse a aplicaciones de medio ambiente limitado. Estos diseños de amortiguadores están a pie de página.

DIÁMETROS DE AMORTIGUADORES

A continuación se muestran los puntos de acotación de los diferentes diámetros por tipo de amortiguador. En la tabla de abajo podrá relacionar las líneas de producto con los diámetros para los distintos calibres de pistón.

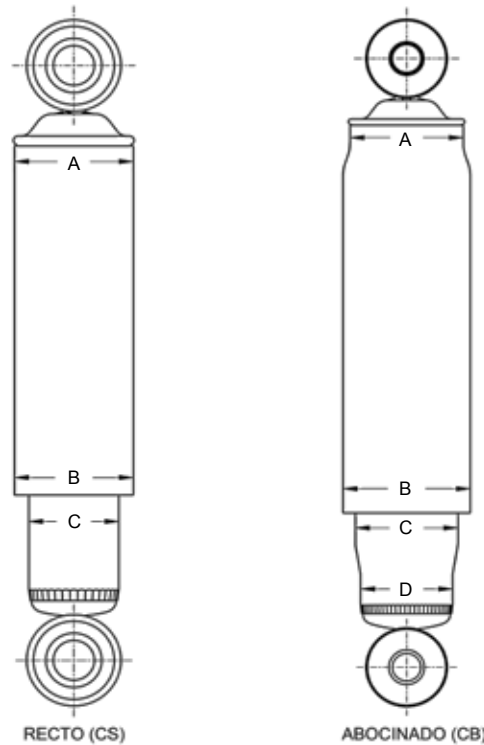

Calibre de Pistón	Línea de Producto	TIPO (Mostrado Arriba)	DIÁMETROS			
			A	B	C	D
1 3/16"	Guardian, Ultra Autos	CS	2.06	2.00	1.63	NA
1 3/16"	Guardian, Ultra Autos	CB	2.06	2.19	1.81	1.63
1 3/8"	Ultra Camionetas	CS	NA	2.37	2.00	NA
1 3/8"	Ultra Camionetas	CB	2.37	2.50	2.19	2.00

MONTAJES CON CÓDIGO “CB” Y “ES” ANILLO Y BUJE CON CAMISA DE ACERO

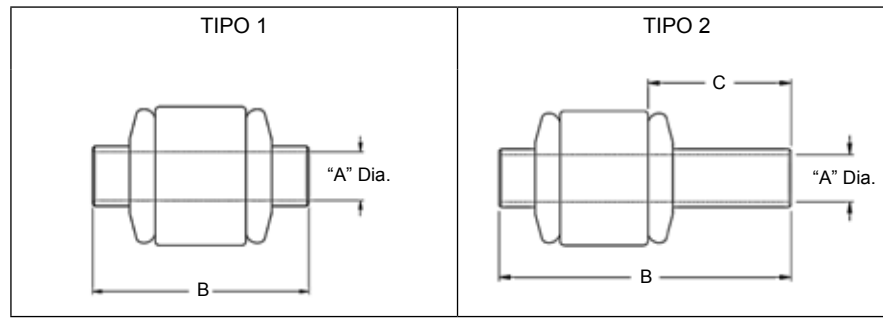

CÓDIGO DE MONTAJE	TIPO	DIÁMETROS			CÓDIGO DE MONTAJE	TIPO	DIÁMETROS			CÓDIGO DE MONTAJE	TIPO	DIÁMETROS		
		A	B	C			A	B	C			A	B	C
ES1	1	10MM	1.25	--	ES56	1	14MM	1.58	--	ES121	1	3/4	2.06	--
ES2	1	10MM	1.42	--	ES57	1	10MM	1.03	--	ES123	1	16MM	1.57	--
ES3	1	10MM	1.56	--	ES58	1	14MM	2.13	--	ES126	1	1/2	2.44	--
ES4	2	1/2	2.20	0.77	ES59	1	15MM	1.56	--	ES128	1	1/2	1.66	--
ES5	1	10MM	2.07	--	ES60	1	14MM	1.26	--	ES130	1	1/2	1.56	--
ES6	1	10MM	2.35	--	ES61	1	12MM	1.76	--	ES133	1	12MM	1.93	--
ES7	1	9/16	1.25	--	ES62	1	12MM	0.98	--	ES136	1	5/8	1.75	--
ES8	1	7/16	1.25	--	ES63	1	15MM	2.28	--	ES137	1	1/2	1.73	--
ES9	1	7/16	1.31	--	ES64	1	16MM	1.25	--	ES138	1	5/8	1.70	--
ES10	1	7/16	1.38	--	ES65	1	12MM	1.38	--	ES139	1	12MM	1.35	--
ES11	1	7/16	1.50	--	ES66	1	16MM	1.38	--	ES141	1	12MM	1.61	--
ES12	1	7/16	1.62	--	ES67	1	16MM	1.56	--	ES142	1	16MM	1.43	--
ES13	1	9/16	1.89	--	ES68	1	9/16	1.35	--	ES143	1	9/16	1.60	--
ES14	1	7/16	1.88	--	ES69	1	12MM	1.58	--	ES145	1	7/16	2.25	--
ES15	1	9/16	2.79	--	ES70	2	7/16	1.88	0.70	ES146	1	12MM	1.37	--
ES16	1	7/16	3.15	--	ES71	1	15MM	2.15	--	ES147	1	12MM	1.97	--
ES17	1	12MM	1.25	--	ES72	1	16MM	1.65	--	ES149	1	1/2	2.36	--
ES18	1	12MM	1.65	--	ES73	1	16MM	1.74	--	ES150	1	3/4	2.24	--
ES19	1	12MM	1.88	--	ES74	1	16MM	1.93	--	ES152	1	20MM	1.69	--
ES20	1	12MM	1.95	--	ES75	1	16MM	2.04	--	ES153	1	14MM	1.55	--
ES21	1	12MM	2.28	--	ES76	1	17/32	1.49	--	ES157	2	1/2	2.05	0.95
ES22	1	1/2	1.25	--	ES77	1	20MM	2.35	--	ES158	1	3/4	3.80	--
ES23	1	1/2	1.31	--	ES78	1	10MM	1.92	--	ES159	2	3/4	3.21	1.03
ES24	1	1/2	1.38	--	ES79	1	21/32	1.58	--	ES160	1	1.00	2.01	--
ES25	1	1/2	1.50	--	ES80	2	25/32	1.69	0.07	ES161	1	16MM	3.95	--
ES26	1	1/2	1.56	--	ES81	1	31/64	1.26	--	ES162	1	16MM	2.60	--
ES27	1	1/2	1.62	--	ES82	1	31/64	1.53	--	ES163	1	7/16	2.50	--
ES28	1	9/16	3.15	--	ES83	1	12MM	1.48	--	ES164	1	1/2	2.26	--
ES29	1	10MM	2.95	--	ES84	1	10MM	1.62	--	ES165	1	1/2	1.75	--
ES30	1	12MM	2.57	--	ES85	1	12MM	2.36	--	ES166	1	5/8	2.97	--
ES31	2	1/2	2.25	1.00	ES86	1	14MM	2.44	--	ES167	1	14MM	2.31	--
ES32	1	1/2	3.34	--	ES87	1	31/64	1.65	--	ES168	1	14MM	2.62	--
ES33	1	12MM	3.15	--	ES88	1	12MM	1.81	--	ES169	1	14MM	1.91	--
ES34	1	9/16	1.66	--	ES89	1	39/64	2.16	--	ES171	1	1/2	1.88	--
ES35	1	5/8	1.38	--	ES90	1	5/8	2.00	--	ES172	1	1/2	2.72	--
ES36	1	3/4	1.75	--	ES91	1	1/2	2.10	--	ES173	1	7/8	2.28	--
ES37	1	12MM	1.01	--	ES92	2	39/64	2.20	0.88	ES174	1	5/8	3.25	--
ES38	1	7/16	2.18	--	ES93	2	39/64	2.57	0.79	ES175	1	16MM	1.96	--
ES39	1	10MM	1.31	--	ES94	1	1/2	2.15	--	ES176	1	16MM	3.72	--
ES40	1	7/16	3.38	--	ES95	1	41/64	2	--	ES177	1	16MM	3.55	--
ES41	1	12MM	3.48	--	ES96	1	45/64	1.57	--	ES178	1	3/4	1.96	--
ES42	1	12MM	3.77	--	ES99	1	14MM	1.42	--	ES179	1	20MM	1.75	--
ES43	1	13MM	1.31	--	ES102	1	10MM	1.77	--	ES181	1	7/16	1.98	--
ES44	1	10MM	2.28	--	ES104	1	20MM	1.58	--	ES182	1	20MM	1.96	--
ES45	1	13MM	1.68	--	ES106	1	10MM	1.48	--	ES183	1	20MM	3.80	--
ES46	1	13MM	1.73	--	ES107	1	12MM	2.15	--	ES184	1	20MM	2.44	--
ES47	1	13MM	2.50	--	ES109	1	10MM	0.95	--	ES185	1	12MM	2.44	--
ES48	1	14MM	1.42	--	ES110	1	16MM	1.61	--	ES187	1	1.00	1.75	--
ES49	1	14MM	1.66	--	ES111	1	9MM	1.78	--	ES188	1	16MM	1.81	--
ES50	1	14MM	1.81	--	ES112	1	12MM	1.08	--	ES190	1	22MM	1.75	--
ES51	1	14MM	1.89	--	ES113	1	16MM	1.49	--	ES191	1	1.00	2.44	--
ES52	1	14MM	1.96	--	ES114	1	12MM	2.04	--	ES192	1	24MM	2.44	--
ES53	1	10MM	1.38	--	ES115	1	10MM	2.02	--	ES193	1	24MM	2.28	--
ES54	1	12MM	2.91	--	ES118	1	12MM	1.31	--	ES194	1	7/8	2.28	--
ES55	1	14MM	2	--	ES120	1	3/4	2.76	--					

MONTAJE “DS” Y “S” CON PLACA

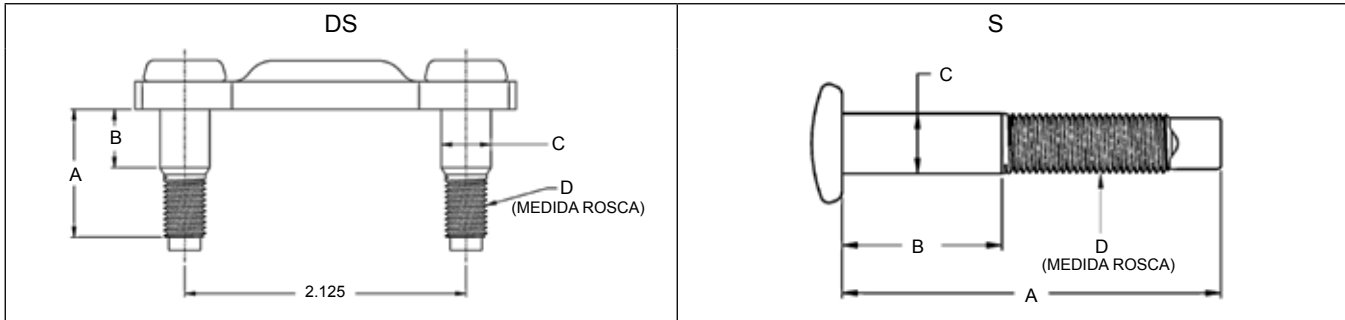

CÓDIGO DE MONTAJE	A	B	C	D
DS1	1.27	0.66	3/8	5/16-24
S1	2.37	1.00	3/8	3/8-24
S2	2.06	1.00	3/8	3/8-24
S3	2.67	1.37	10MM	3/8-16
S4	1.85	1.00	3/8	3/8-24
S5	1.29	1.14	13MM	3/8-24
S6	2.47	1.47	7/16	3/8-24
S7	1.97	1.00	3/8	3/8-24
S8	1.75	1.00	10MM	3/8-24
S9	1.84	1.05	7/16	3/8-24
S10	2.37	1.33	7/16	3/8-24
S11	3.00	1.12	3/8	3/8-24
S12	2.37	1.15	7/16	3/8-24
S13	2.06	1.35	3/8	3/8-24
S14	2.25	1.33	7/16	3/8-24
S15	3.29	1.98	3/8	3/8-24
S16	2.95	1.45	16MM	16MM
S17	2.15	1.03	7/16	3/8-24
S18	2.67	1.81	10MM	M10x1.25
S19	1.34	0.41	7/16	M10x1
S20	1.34	0.41	10MM	M10x1
S21	3.28	1.75	5/8	5/8-18
S22	0.75	0.35	10MM	M10x1
S23	1.84	1.05	3/8	3/8-24
S24	1.22	0.31	11MM	M10x1
S25	1.81	1.50	3/8	M10x1
S26	2.02	0.82	12MM	M10x1
S27	2.36	1.14	10MM	M10x1
S28	2.44	1.37	12MM	M10x1
S29	2.99	1.87	3/8	3/8-24
S30	2.59	1.41	10MM	M10x1
S31	0.79	0.40	17MM	10MM
S32	2.31	1.38	14MM	12MM
S33	3.44	2.17	10MM	M10x1
S34	1.06	0.59	5/16	M8x1.25
S35	2.60	1.12	7/16	3/8-24

CÓDIGO DE MONTAJE	A	B	C	D
S36	2.49	1.33	7/16	3/8-24
S37	3.18	1.41	12MM	M10x1
S38	2.75	1.70	14MM	12MM
S39	2.20	1.31	10MM	10MM
S40	2.52	1.33	7/16	3/8-24
S41	3.48	2.32	5/8	1/2-20
S42	3.50	2.00	5/8	5/8-18
S43	2.75	1.25	5/8	5/8-18
S44	1.57	0.39	10MM	M10x1.25
S45	2.36	1.00	10MM	M10x1.25
S46	1.57	1.18	10MM	M10x1.25
S47	2.20	1.31	10MM	M10x1.25
S48	2.55	1.51	10MM	M10x1.25
S49	2.67	1.29	10MM	M10x1.25
S50	2.95	1.57	10MM	M10x1.25
S51	3.00	1.65	10MM	M10x1.25
S52	1.18	0.74	10MM	M10x1.5
S53	2.16	1.89	10MM	M10x1.5
S54	2.42	1.28	15MM	M10x1.5
S55	2.51	1.39	10MM	M10x1.5
S56	2.67	1.53	11MM	M10x1.5
S57	2.95	1.40	27/64	M10x1.5
S58	2.98	1.68	10MM	M10x1.5
S59	2.98	1.68	12MM	M10x1.5
S60	3.46	1.96	9/16	M10x1.5
S61	3.11	1.45	14MM	M12x1.25
S62	3.24	1.70	9/16	M12x1.25
S63	3.54	2.24	17MM	M12x1.25
S64	2.36	1.18	12MM	M12x1.5
S65	2.89	1.65	12MM	M12x1.5
S66	1.39	0.15	12MM	M12x1.75
S67	2.40	1.53	9/16	M14x1.5
S68	2.95	1.45	5/8	M16x1.5
S69	1.32	1.37	39/64	M16x2
S70	1.88	0.90	7/16	M8x1.25

MONTAJE "BP" CON ANILLO Y PERNO TUBULAR

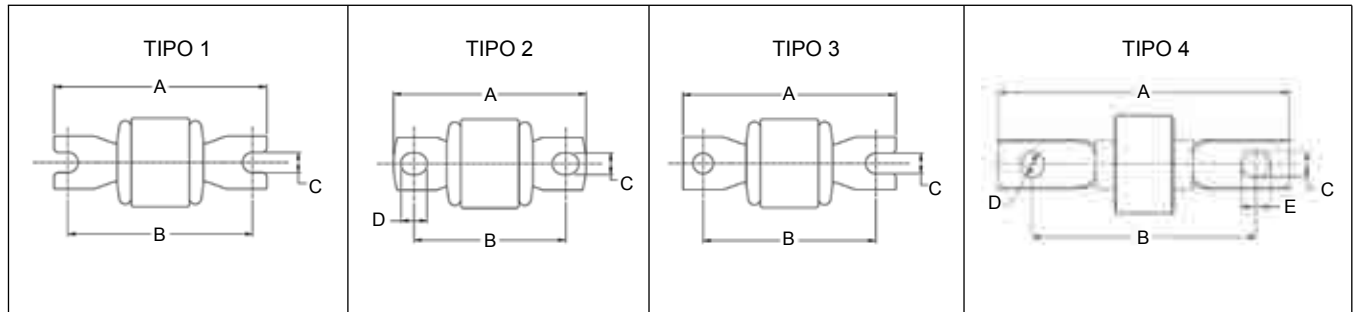

CÓDIGO DE MONTAJE	TIPO	A	B	C	D	E
BP1	1	2.72	2.20	0.33	--	--
BP2	1	3.59	3.12	0.32	--	--
BP3	1	2.82	2.38	0.33	--	--
BP4	1	3.19	2.38	0.33	--	--
BP5	1	3.19	2.75	0.33	--	--
BP6	1	4.25	3.62	0.33	--	--
BP7	2	3.13	2.50	0.35	0.42	--
BP8	2	3.50	2.87	0.35	0.42	--
BP9	1	3.38	2.60	0.35	0.57	--
BP10	2	3.5	2.74	0.50	0.50	--
BP11	1	2.96	2.52	0.33	--	--
BP12	1	3.75	3.14	0.33	--	--
BP13	1	3.45	3.00	0.33	--	--
BP14	2	3.43	2.87	0.45	--	--

CÓDIGO DE MONTAJE	TIPO	A	B	C	D	E
BP15	4	4.56	3.62	0.39	0.47	0.39
BP17	1	3.11	2.61	0.33	--	--
BP18	1	3.75	3.14	0.39	--	--
BP19	1	3.19	2.62	0.33	--	--
BP20	1	3.59	3.12	0.33	--	--
BP26	3	3.06	2.37	0.26	--	--
BP27	2	4.00	2.95	0.52	0.50	--
BP29	2	4.00	2.95	0.37	0.49	--
BP30	1	3.00	2.25	0.34	--	--
BP31	3	3.50	2.87	0.35	--	--
BP32	2	3.45	2.83	0.42	--	--
BP33	2	4.44	3.62	0.39	0.47	--
BP34	1	3.81	2.99	0.41	--	--
BP35	2	3.53	2.73	0.38	0.38	--

MONTAJES ESPECIALES CÓDIGO "SP"

Los números de parte con código de montaje "SP", son especiales para la aplicación. Por favor utilice como referencia la pieza de Equipo Original o GRC para dimensiones. Si tiene preguntas o comentarios, favor de contactar a El Experto al 01.800.1227.846

MONTAJE "EB" CON ANILLO U BUJE

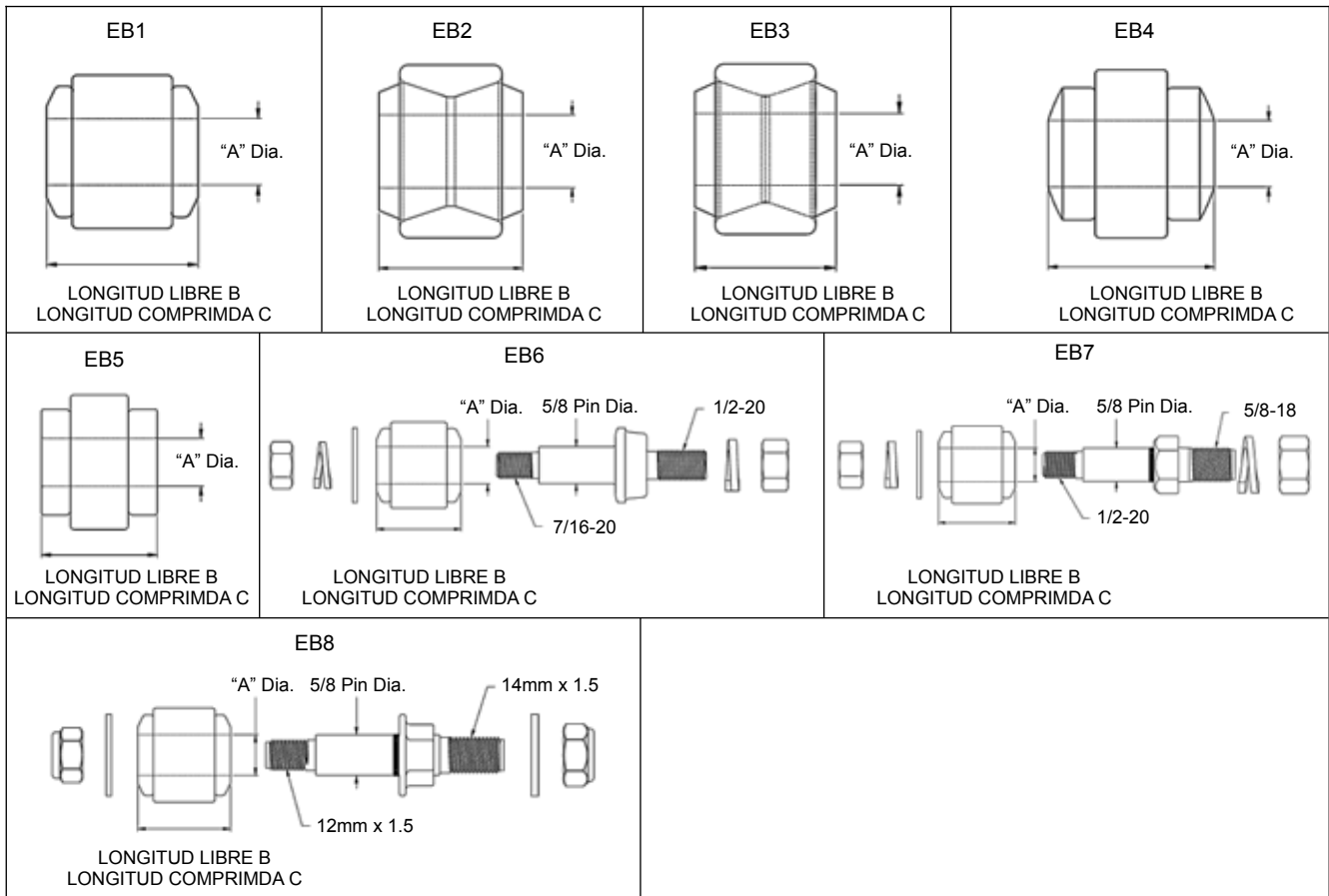

CÓDIGO DE MONTAJE	A Diámetro	B Longitud Libre	C Longitud Comprimida	DIÁMETRO DEL PERNO DE MONTAJE EN EL VEHÍCULO
EB1	5/8	1.44	1.31	5/8
EB2	3/4	1.75	1.50	3/4
EB3	1.00	1.91	1.75	1.00
EB4	11/16	1.72	1.55	11/16
EB5	5/8	1.51	1.25	5/8
EB6	5/8	1.44	1.31	Amortiguador equipado con perno de montaje de 1/2 dia. Orificio de montaje en el vehículo.
EB7	5/8	1.44	1.31	Amortiguador equipado con perno de montaje de 5/8 dia. Orificio de montaje en el vehículo.
EB8	5/8	1.44	1.31	Amortiguador equipado con perno de montaje de 1.44mm dia. Orificio de montaje en el vehículo.
EB9	1	1.75	--	1
EB10	1.00	1.00	--	1.00
EB11	3/8	0.83	--	3/8
EB12	10MM	1.18	--	10MM
EB13	12MM	1.03	--	12MM
EB14	15MM	1.41	--	15MM
EB15	15MM	1.76	--	15MM
EB16	16MM	1.5	--	16MM
EB17	17MM	1.18	--	17MM
EB18	19MM	1.65	--	19MM
EB19	20MM	1.75	--	20MM
EB20	45/64	1.05	--	45/64
EB21	45/64	1.39	--	45/64

CÓMO DESHACERSE DE AMORTIGUADORES Y STRUTS PRESURIZADOS DE GAS VIEJOS O DEFECTUOSOS

ALMACENAMIENTO DE AMORTIGUADORES Y STRUTS USADOS

Los struts y amortiguadores deben almacenarse para que el aceite se pueda recoger. Los recipientes que se usen para almacenar este producto deben tener una etiqueta que diga: "ACEITE USADO".

Los struts y amortiguadores pueden ser perforados para reciclar el aceite o deshacerse de una manera constante con un programa local o del estado.

RECICLAJE DEL ACEITE DE AMORTIGUADOR Y STRUT

1. PARA SU SEGURIDAD, SIEMPRE USE ANTEOJOS DE SEGURIDAD Y GUANTES CUANDO PERFORE LOS STRUTS Y LOS AMORTIGUADORES
2. Monte finamente en una prensa el strut o amortiguador en posición horizontal. Asegúrese de que la barra esté totalmente extendida antes de taladrar la unidad (Fig. #1).
3. Use una broca de taladro de 1/16" o de 1/8", taladre un hueco en dirección al suelo, aproximadamente a 1" de la parte inferior del strut o amortiguador (Fig. #2). Es importante cubrir con una toalla el área donde se está perforando, para evitar que el gas y el aceite salten por todas partes cuando haga la primera incisión con la broca.
4. Después de que la presión del gas salga continúe taladrando dentro del cilindro interior del strut o amortiguador, aproximadamente 1/2" de profundidad. Taladre un segundo orificio de 1/2" cerca de la parte superior de la pieza.
5. Remueva el strut o amortiguador de la prensa y sosténgalo sobre un recipiente para recolectar el aceite usado. Sacuda la unidad para sacarle completamente el aceite del cilindro de la unidad. (Fig. #3).
6. Recoja el aceite usado, **tenga cuidado de no mezclar este aceite con otro desperdicio o basura.** Almacene en recipientes aprobados por la SEMARNAT con una etiqueta que diga: "ACEITE USADO."
7. Deshágase del resto de las piezas y componentes internos del strut o amortiguador de acuerdo con las regulaciones locales o del estado (por ejemplo: reciclaje para restos de metal).
8. Almacene, deshágase, y/o lleve el aceite usado de acuerdo con las regulaciones de la SEMARNAT y el programa de aceite usado.

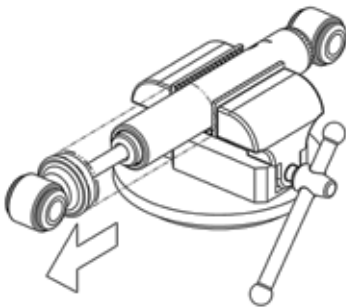

FIG. #1

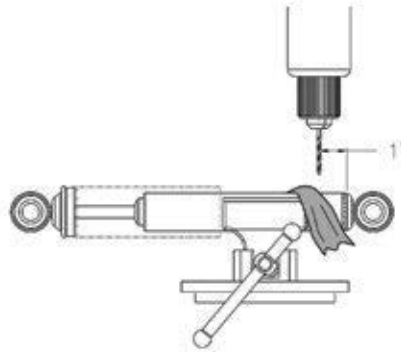

FIG. #2

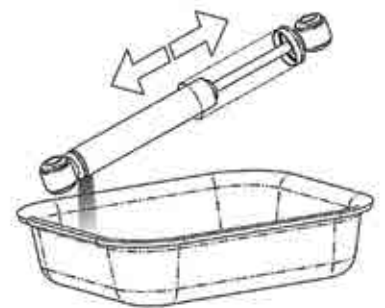

FIG. #3

NÚMERO DE FABRICACIÓN VS GRC

No. DE FABRICACIÓN	No. GRC	No. DE FABRICACIÓN	No. GRC	No. DE FABRICACIÓN	No. GRC	No. DE FABRICACIÓN	No. GRC
14004	14004	142230	142230	142402	142402	142568	142568
141099	141099	142231	142231	142403	142403	142569	142569
141577	141577	142233	142233	142404	142404	142570	142570
141578	141578	142234	142234	142405	142405	142571	142571
141580	141580	142237	142237	142406	142406	142572	142572
141974	141974	142240	142240	142408	142408	142573	142573
142091	142091	142241	142241	142409	142409	142623	142623
142092	142092	142242	142242	142411	142411	142625	142625
142103	142103	142244	142244	142412	142412	142626	142626
142108	142108	142245	142245	142413	142413	142639	142639
142132	142132	142247	142247	142415	142415	142640	142640
142133	142133	142248	142248	142419	142419	142641	142641
142134	142134	142249	142249	142426	142426	142642	142642
142135	142135	142250	142250	142427	142427	142643	142643
142136	142136	142251	142251	142428	142428	142646	142646
142141	142141	142252	142252	142429	142429	142647	142647
142142	142142	142254	142254	142430	142430	142648	142648
142143	142143	142292	142292	142435	142435	142649	142649
142144	142144	142293	142293	142436	142436	142650	142650
142145	142145	142294	142294	142437	142437	142651	142651
142146	142146	142295	142295	142439	142439	142652	142652
142148	142148	142296	142296	142440	142440	142653	142653
142150	142150	142297	142297	142442	142442	142654	142654
142173	142173	142298	142298	142444	142444	142734	142734
142183	142183	142300	142300	142521	142521	142735	142735
142189	142189	142301	142301	142524	142524	142738	142738
142190	142190	142302	142302	142525	142525	142741	142741
142193	142193	142303	142303	142526	142526	142744	142744
142194	142194	142304	142304	142527	142527	142745	142745
142195	142195	142306	142306	142529	142529	142746	142746
142196	142196	142307	142307	142530	142530	142747	142747
142197	142197	142311	142311	142531	142531	142748	142748
142217	142217	142316	142316	142532	142532	142749	142749
142219	142219	142317	142317	142535	142535	142750	142750
142220	142220	142321	142321	142536	142536	142751	142751
142221	142221	142325	142325	142543	142543	142752	142752
142222	142222	142326	142326	142546	142546	142753	142753
142223	142223	142329	142329	142547	142547	142754	142754
142224	142224	142330	142330	142550	142550	142755	142755
142225	142225	142334	142334	142556	142556	142757	142757
142226	142226	142335	142335	142559	142559	142762	142762
142227	142227	142393	142393	142561	142561	142763	142763
142228	142228	142396	142396	142562	142562	142803	142803
142229	142229	142399	142399	142567	142567	142825	142825

NÚMERO DE FABRICACIÓN VS GRC

No. DE FABRICACIÓN	No. GRC	No. DE FABRICACIÓN	No. GRC	No. DE FABRICACIÓN	No. GRC	No. DE FABRICACIÓN	No. GRC
142826	142826	142992	142992	143199	143199	143278	143278
142827	142827	143030	143030	143200	143200	143279	143279
142828	142828	143031	143031	143201	143201	143280	143280
142832	142832	143032	143032	143202	143202	143281	143281
142834	142834	143035	143035	143204	143204	143284	143284
142836	142836	143036	143036	143205	143205	143285	143285
142837	142837	143037	143037	143206	143206	143287	143287
142838	142838	143057	143057	143207	143207	143288	143288
142840	142840	143058	143058	143208	143208	143289	143289
142841	142841	143059	143059	143209	143209	143290	143290
142842	142842	143060	143060	143210	143210	143292	143292
142843	142843	143061	143061	143214	143214	143299	143299
142844	142844	143062	143062	143218	143218	143300	143300
142845	142845	143063	143063	143219	143219	143305	143305
142846	142846	143064	143064	143220	143220	143309	143309
142847	142847	143067	143067	143221	143221	143315	143315
142850	142850	143071	143071	143222	143222	143316	143316
142851	142851	143072	143072	143223	143223	143317	143317
142852	142852	143073	143073	143224	143224	143318	143318
142853	142853	143074	143074	143226	143226	143319	143319
142854	142854	143082	143082	143227	143227	143320	143320
142855	142855	143083	143083	143228	143228	143321	143321
142856	142856	143084	143084	143231	143231	143322	143322
142857	142857	143086	143086	143233	143233	143323	143323
142858	142858	143087	143087	143235	143235	143324	143324
142859	142859	143088	143088	143236	143236	143325	143325
142860	142860	143089	143089	143239	143239	143328	143328
142861	142861	143090	143090	143240	143240	143330	143330
142862	142862	143091	143091	143241	143241	143335	143335
142880	142880	143092	143092	143242	143242	143336	143336
142930	142930	143093	143093	143244	143244	143337	143337
142931	142931	143094	143094	143246	143246	143338	143338
142932	142932	143112	143112	143248	143248	143339	143339
142933	142933	143113	143113	143253	143253	143340	143340
142935	142935	143116	143116	143255	143255	143341	143341
142936	142936	143139	143139	143256	143256	143342	143342
142937	142937	143140	143140	143259	143259	143344	143344
142938	142938	143191	143191	143262	143262	143345	143345
142939	142939	143193	143193	143263	143263	143348	143348
142940	142940	143194	143194	143264	143264	143349	143349
142941	142941	143195	143195	143265	143265	143350	143350
142942	142942	143196	143196	143266	143266	143352	143352
142943	142943	143197	143197	143267	143267	143353	143353
142949	142949	143198	143198	143277	143277	143354	143354

NÚMERO DE FABRICACIÓN VS GRC

No. DE FABRICACIÓN	No. GRC	No. DE FABRICACIÓN	No. GRC	No. DE FABRICACIÓN	No. GRC	No. DE FABRICACIÓN	No. GRC
143355	143355	143423	143423	721001	14016	727511	70160
143356	143356	143424	143424	721003	14018	727512	70161
143357	143357	143455	143455	721004	14019	727513	70162
143358	143358	143456	143456	721005	14020	727514	70163
143360	143360	143457	143457	721006	14010	727515	70164
143361	143361	143458	143458	721062	14039	727516	70165
143362	143362	143459	143459	721063	14040	727517	70166
143363	143363	143460	143460	721070	14017	727518	70167
143364	143364	143461	143461	721073	14071	727519	70168
143365	143365	143462	143462	721087	14072	727520	70169
143367	143367	143463	143463	721089	14074	727521	70170
143368	143368	143464	143464	721090	14075	727522	70171
143369	143369	143465	143465	721091	14076	727523	70172
143379	143379	143466	143466	721092	14077	727524	70173
143385	143385	143468	143468	721555	55745	727526	70175
143386	143386	143469	143469	721556	55746	727527	70176
143387	143387	143473	143473	721563	55526	727600	83200
143388	143388	143475	143475	721570	55514	727603	83203
143389	143389	143476	143476	722514	34036	727604	83204
143393	143393	143477	143477	722518	34051	727607	83207
143394	143394	143486	143486	722519	34052	727609	83209
143395	143395	143491	143491	722522	34058	727614	83214
143397	143397	143492	143492	722532	34057	727615	83215
143398	143398	143495	143495	722535	34073	727616	83216
143399	143399	143496	143496	722540	34076	727617	83217
143400	143400	143497	143497	723279	55976	727619	83219
143401	143401	143498	143498	723280	55977	727621	83221
143402	143402	143509	143509	723281	56743	727625	83225
143404	143404	143510	143510	723282	56744	727628	83301
143405	143405	143516	143516	723283	56980	727630	83303
143406	143406	143517	143517	723284	56630	727631	83304
143408	143408	143522	143522	723285	55991	727635	83308
143409	143409	143528	143528	723288	55657	727636	83309
143410	143410	143530	143530	723289	55658	727639	83312
143411	143411	143531	143531	723290	55977	727641	83314
143412	143412	143532	143532	723291	55976	727644	83317
143413	143413	143533	143533	723665	55657	727645	83318
143414	143414	143552	143552	723666	55658	727692	83353
143415	143415	143553	143553	725431	42446	727741	83362
143416	143416	143554	143554	725651	42530	727761	83613
143417	143417	143564	143564	725790	42577	729010	43048
143418	143418	695406	695406	726927	83456	729011	43049
143421	143421	710000	40026	727297	55713	729017	43060
143422	143422	710001	40027	727510	70159	729018	43062

NÚMERO DE FABRICACIÓN VS GRC

No. DE FABRICACIÓN	No. GRC	No. DE FABRICACIÓN	No. GRC	No. DE FABRICACIÓN	No. GRC	No. DE FABRICACIÓN	No. GRC
729021	43067	729551	58360	729633	58623	729763	49199
729028	43084	729553	58421	729634	58624	729765	49203
729029	43085	729554	58423	729635	58638	729767	49205
729031	43093	729555	58489	729636	58661	729768	49127
729033	43096	729556	58609	729637	58662	729769	49207
729035	43099	729557	58625	729638	58673	729770	49151
729037	43107	729558	58671	729639	58674	729771	49214
729041	43111	729559	58714	729640	58675	729773	49212
729058	43138	729560	58908	729641	58901	729774	49217
729064	43140	729561	58906	729642	58715	729775	49213
729065	43058	729562	58929	729643	58716	729776	49215
729066	43142	729563	58403	729644	58717	729777	49216
729069	43143	729600	58183	729645	58783	729778	49218
729084	43165	729601	58347	729646	58803	729780	49221
729086	43161	729602	58349	729647	58807	729782	49222
729087	43162	729603	58350	729648	58808	729783	49223
729088	43163	729604	58353	729649	58809	729785	49225
729089	43167	729605	58355	729650	58810	729786	49226
729093	43171	729606	58357	729651	58811	729788	49228
729094	43172	729607	58366	729655	58812	729789	49229
729095	43173	729608	58377	729656	58817	729844	49230
729202	49304	729609	58386	729662	58930	729206	49309
729204	49307	729610	58387	729675	58943	729791	49231
729207	49310	729611	58389	729676	58944	729794	49241
729208	49311	729612	58394	729677	58945	729806	49254
729224	49334	729613	58778	729701	49105	729810	49255
729230	49345	729614	58406	729702	49106	729815	49221
729231	49346	729615	58409	729703	49107	729837	49213
729249	49369	729616	58410	729706	49110	729840	49222
729261	49370	729617	58411	729709	49114	729902	43180
729262	49371	729618	58412	729714	49122	729903	43181
729272	49381	729619	58413	729719	49128	730735	42954
729279	49387	729620	58414	729720	49131	730736	42955
729280	49388	729621	58416	729721	49149	730737	51091
729282	49613	729622	58422	729724	49135	730738	42956
729283	49614	729624	58437	729732	49152	730739	42957
729284	49236	729625	58438	729733	49155	730740	42958
729285	49616	729626	58455	729734	49193	730741	42959
729303	49232	729627	58456	729735	49157	730742	42960
729304	49233	729628	58461	729740	49162	730743	42961
729305	49234	729629	58488	729745	49173	730744	42962
729306	49235	729630	58500	729750	49178	730745	42963
729308	49237	729631	58617	729760	49196	730746	42964
729550	58359	729632	58622	729761	49197	730747	42965

NÚMERO DE FABRICACIÓN VS GRC

No. DE FABRICACIÓN	No. GRC	No. DE FABRICACIÓN	No. GRC	No. DE FABRICACIÓN	No. GRC	No. DE FABRICACIÓN	No. GRC
730748	42966	733156	143474	733492	G55857	733679	81560
730749	42967	733300	G55730	733493	G55858	733680	81559
730750	42968	733302	G55743	733503	81492	733682	81558
730751	42969	733303	G55757	733505	81495	733684	81542
730752	42970	733306	G55742	733508	81340	733685	81553
730753	42971	733307	G55763	733509	81416	733688	81285
730754	42972	733308	G55766	733510	81498	733689	81113
730755	42973	733309	G55769	733512	81501	733690	81108
730756	42952	733310	G55770	733518	81147	733691	81242
730757	42953	733311	G55771	733522	81478	733692	81484
730758	42161	733312	G55773	733523	81095	733693	81490
730760	42459	733313	G55774	733526	81517	733694	81394
730761	42517	733315	G55781	733527	81494	733695	81496
730762	42520	733316	G55782	733527	81750	733696	81096
730763	42508	733317	G55786	733528	81097	733697	81164
730764	42094	733318	G55787	733530	81318	733698	81039
730902	51006	733319	G55788	733532	81459	733699	81270
730915	51022	733320	G51039	733533	81460	734400	G44713
730950	G51165	733321	G51186	733534	81469	734409	G44735
730951	G51330	733323	G51192	733565	81440	734411	G44724
730953	G51346	733324	G51180	733575	81446	734427	G44723
730957	G51204	733329	G55723	733576	81481	734429	G44745
731067	G51007	733330	G51173	733589	81464	734435	G44800
731074	G51027	733331	G51183	733591	81491	734436	G44747
731074	G51047	733332	G51181	733592	81338	734437	G44802
731103	G51216	733333	G51182	733594	81076	734438	G44803
731108	G51006	733335	G55795	733599	81153	734439	G44748
731109	G51013	733336	G55796	733602	81322	734452	G44806
731110	G51017	733337	G55797	733604	81461	734453	G44743
731112	G51022	733338	G55802	733609	81406	734500	G44763
731113	G51030	733339	G55803	733611	81445	734502	G44752
731114	G51033	733340	G55804	733614	81508	734514	G44773
731117	G51184	733341	G55805	733620	81507	734520	G44774
731118	G51424	733461	G55952	733625	81514	734521	G44766
731119	G51046	733466	G55857	733628	81438	734522	G44767
731120	G51063	733467	G55858	733637	81450	734523	G44776
731125	G51229	733468	G55859	733642	81541	734526	G44775
731127	G51232	733469	G55860	733649	81530	734535	G44783
731130	G51249	733470	G55865	733651	81557	734602	G44869
731131	G51253	733471	G55866	733653	81671	734603	G44868
731131	G51254	733472	G55867	733655	81674	734604	G44867
731134	G51714	733473	G55868	733656	81555	734606	G44862
732104	44763	733476	G55870	733658	81693	734607	G44850
732641	44902	733477	G55871	733660	81554	734611	G44856

NÚMERO DE FABRICACIÓN VS GRC

No. DE FABRICACIÓN	No. GRC	No. DE FABRICACIÓN	No. GRC	No. DE FABRICACIÓN	No. GRC	No. DE FABRICACIÓN	No. GRC
734612	G44902	736502	G56700	736787	G55531	737691	G63908
734613	G44903	736505	G56701	736788	G55527	737692	G63902
734622	G44898	736507	G56703	736789	G55561	737693	G63906
734633	G44926	736513	G56707	736790	G55713	737694	G63903
734634	G44918	736514	G56708	736791	G55726	737695	G63909
734639	G44920	736518	G56714	736794	G55546	737696	G63915
734646	G44934	736519	G56713	736795	G55557	737697	69616
734648	G44937	736520	G56705	736797	G55579	737699	69760
734649	G44936	736521	G56706	736799	G55580	737900	G63353
734650	G44938	736522	G56715	736800	83400	737901	G63405
734651	G44939	736523	G56716	736801	83401	737902	G63420
734651	G44982	736524	G56717	737556	G63434	737903	G63398
734652	G44940	736525	G56718	737601	69675	737904	G63423
734653	G44941	736526	G56719	737602	69632	737905	G63421
734654	G44943	736527	G56720	737603	69633	737906	G63427
734655	G44944	736536	G56723	737606	69676	737907	G63406
734658	G44947	736537	G56724	737609	69704	737907	G63809
734663	G44968	736538	G56903	737613	69880	737908	G63426
734673	G44969	736539	G56704	737619	69706	737908	G63690
734675	G44986	736551	G44450	737623	69604	737909	G63484
734684	G44990	736552	G44451	737625	69600	737910	G63410
734690	G44994	736555	G44459	737627	69606	737914	G63366
734691	G44995	736557	G44991	737631	69703	737915	G63359
734695	G44997	736558	G44461	737633	69624	737917	G63409
734696	G44998	736675	G44986	737642	69723	737918	G63422
734697	G44999	736711	G55510	737649	69709	737919	G63492
734698	G44477	736715	G55507	737680	69671	737920	G63404
735509	69683	736717	G55511	737650	69724	737922	G63350
735629	69726	736718	G55509	737654	69674	737923	G63386
735919	G51031	736720	G55512	737657	69713	737924	G63299
735922	G51034	736721	G56504	737658	69727	737925	G63347
735934	G51190	736722	G55516	737659	69749	737926	G63357
735935	G51188	736724	G56503	737661	69622	737927	G63457
735936	G51189	736728	G55515	737662	69625	737928	G63375
735937	G51191	736734	G55533	737670	69714	737929	G63454
735943	G51193	736743	G55529	737671	69715	737931	G63355
736001	G51195	736751	G55534	737672	69725	737932	G63377
736002	G51196	736752	G55705	737673	69755	737933	G63414
736003	G51197	736757	G55539	737674	69756	737934	G63413
736023	G51060	736762	G55521	737678	69757	737935	G63306
736032	G51170	736770	G55551	737679	69670	737936	G63387
736040	G51064	736778	G55716	737686	69794	737937	G63349
736049	G51078	736782	G55544	737687	69795	737938	G63183
736103	G51161	736783	G55542	737689	69733	737939	G63389

NÚMERO DE FABRICACIÓN VS GRC

No. DE FABRICACIÓN	No. GRC	No. DE FABRICACIÓN	No. GRC	No. DE FABRICACIÓN	No. GRC	No. DE FABRICACIÓN	No. GRC
737940	G63424	737994	G63432	738289	81821	738359	81920
737940	G63847	737995	G63173	738290	81744	738360	81921
737941	G63425	737999	G63403	738291	81823	738361	81922
737943	G63488	738000	81091	738293	81825	738362	81923
737944	G63489	733678	81562	738294	81826	738363	81924
737946	G63491	738002	81342	738296	81828	738364	81925
737949	G63494	738005	81482	738301	81833	738365	81926
737952	G63416	738007	81510	738302	81834	738366	81927
737953	G63418	738008	81516	738304	81836	738367	81928
737954	G63360	738009	81538	738305	81837	738368	81929
737956	G63460	738010	81539	738320	81870	738369	81930
737957	G63396	738011	81540	738321	81871	738370	81931
737960	G63500	738012	81548	738322	81872	738371	81932
737961	G63502	738012	81869	738323	81873	738372	81933
737962	G63524	738013	81549	738324	81882	738373	81934
737962	G63775	738015	81174	738325	81893	738374	81935
737963	G63525	738016	81529	738326	81890	738375	81936
737963	G63773	738017	81581	738327	81891	738376	81937
737965	G63490	738018	81582	738328	81878	739001	82001
737966	G63511	738019	81583	738329	81892	739002	82002
737967	G63547	738050	81726	738330	81880	739003	82003
737968	G63548	738055	81667	738331	81881	739004	82004
737971	G63607	738056	81668	738332	81900	739005	82005
737972	G63608	738063	81670	738333	81894	739006	82006
737973	G63479	738067	81082	738334	81884	739007	82007
737974	G63495	738079	81675	738335	81896	739010	82010
737975	G63614	738080	81676	738336	81897	739011	82011
737976	G63455	738082	81691	738337	81898	739012	82012
737993	G63456	738095	81694	738341	81902	739013	82013
737976	G63717	738121	81710	738343	81904	739020	82020
737978	G63620	738124	81713	738344	81905	739025	82025
737979	G63621	738125	81714	738345	81906	739026	82026
737980	G63624	738151	81727	738346	81907	739030	82030
737981	69766	738158	81730	738347	81908	739031	82031
737984	G63419	738160	81739	738348	81909	739032	82032
737985	G63638	738162	81741	738349	81910	739033	82033
737986	G63499	738163	81742	738350	81911	739034	82034
737987	G63461	738255	81789	738351	81912	739035	82035
737987	G63811	738256	81790	738352	81913	739038	82038
737988	G63660	738257	81791	738353	81914	739039	82039
737989	G63661	738258	81792	738355	81916	739040	82040
737990	G63662	738259	81793	738356	81917	739046	82046
737991	G63635	738260	81794	738357	81918	739047	82047
737992	G63639	738261	81795	738358	81919	739049	82049

NÚMERO DE FABRICACIÓN VS GRC

No. DE FABRICACIÓN	No. GRC	No. DE FABRICACIÓN	No. GRC	No. DE FABRICACIÓN	No. GRC	No. DE FABRICACIÓN	No. GRC
739051	82051	739453	G51477	739510	G51735	739582	G51807
739054	82054	739454	G55820	739511	G51736	739583	G51736
739060	82060	739455	G55877	739512	G51737	739585	G51779
739062	82062	739456	G51252	739513	G51738	739585	G51810
739065	82065	739457	G51255	739514	G51739	739586	G51780
739066	82066	739458	G51256	739515	G51740	739586	G51811
739067	82067	739460	G51087	739517	G51742	739587	G51812
739069	82069	739461	G51264	739518	G51743	739588	G51813
739070	82070	739464	G51265	739519	G51744	739589	G51814
739072	82072	739466	G51227	739521	G51746	739590	G51815
739074	82074	739467	G55819	739522	G51747	739591	G51195
739075	82075	739468	G51268	739531	G51756	739607	G51099
739076	82076	739470	G51290	739532	G51757	739608	G51100
739079	82079	739471	G51294	739533	G51758	739609	G51101
739086	82086	739472	G51295	739534	G51759	739637	G51740
739087	82087	739473	G51286	739535	G51760	739638	G51868
739089	82089	739474	G51279	739536	G51761	739639	G51869
739090	82090	739475	G51700	739539	G51764	739649	G51097
739093	82093	739476	G51729	739540	G51765	739650	G51870
739099	82099	739478	G51703	739541	G51766	739653	G51825
739103	82103	739479	G51704	739542	G51767	739654	G51826
739104	82104	739480	G51705	739543	G51768	739655	G51827
739109	82109	739481	G51706	739544	G51769	739656	G51828
739110	82110	739484	G51709	739545	G51770	739657	G51829
739118	82118	739485	G51710	739546	G51771	739658	G51830
739123	82123	739486	G51711	739547	G51772	739659	G51831
739124	82124	739487	G51712	739548	G51773	739660	G51832
739125	82125	739488	G51713	739549	G51774	739661	G51833
739126	82126	739490	G51715	739558	G51783	739662	G51834
739128	82128	739491	G51716	739569	G51794	739663	G51835
739129	82129	739493	G51718	739570	G51795	739664	G51836
739130	82130	739494	G51719	739571	G51265	739665	G51837
739131	82131	739495	G51720	739571	G51796	739666	G51838
739138	82138	739496	G51721	739571	G51267	739667	G51839
739139	82139	739497	G51722	739572	G51078	739668	G51840
739147	82147	739498	G51723	739573	G51798	739669	G51841
739151	82151	739499	G51724	739574	G51799	739670	G51842
739155	82155	739500	G51725	739575	G51800	739678	G51847
739156	82156	739502	G51727	739576	G51801	739679	G51848
739400	G55818	739503	G51728	739577	G51802	739680	G51849
739403	G55821	739504	G51729	739578	G51803	739681	G51850
739406	G55825	739505	G51730	739579	G51804	739683	G51852
739434	G51230	739506	G51731	739580	G51805	739684	G51853
739452	G51077	739508	G51733	739581	G51806	739685	G51854

NÚMERO DE FABRICACIÓN VS GRC

No. DE FABRICACIÓN	No. GRC	No. DE FABRICACIÓN	No. GRC	No. DE FABRICACIÓN	No. GRC	No. DE FABRICACIÓN	No. GRC
739686	G51855	740033	77673	740095	77726	744890	6855SE
739687	G51856	740034	77678	740096	77937	744891	6856SE
739688	G51857	740035	77679	740097	77772	744892	6857SE
739689	G51858	740036	77683	740098	77915	744893	6858SE
739690	G51859	740037	77714	740103	77947	744894	6859SE
739692	G51860	740038	77715	740104	77948	744895	6860SE
739693	G51861	740039	77716	740105	77949	744896	6861SE
739695	G51863	740040	77717	740106	77950	744897	6862SE
739696	G51864	740041	77778	740107	77951	744898	6863SE
739697	G51865	740042	77783	740108	77952	746501	G55945
740001	77349	740043	77803	740109	77953	746504	G55948
740002	77355	740044	77902	740110	77954	746505	G55949
740003	77357	740045	77903	740111	77955	746507	G55951
740004	77359	740046	77904	740114	77958	746514	G55958
740005	77375	740047	77907	740123	77967	746544	G56518
740067	77377	740048	77909	740124	77968	746568	G56607
740006	77406	740049	77403	740125	77969	746569	G56608
740007	77409	740050	75898	740165	77975	746573	G56649
740008	77410	740051	77456	740166	77976	746606	G55856
740009	77412	740052	77494	740168	77978	746612	G55525
740010	77413	740053	77674	740169	77979	746615	G55992
740011	77414	740054	77675	740170	77980	746618	G55993
740012	77421	740055	77454	740172	77981	746619	G55994
740013	77422	740056	77781	740174	77983	746620	G55960
740014	77423	740057	77807	740502	79900	746624	G55978
740015	77424	740058	77808	740503	79901	746625	G56509
740015	77847	740059	77809	744800	6807SE	746633	G56611
740016	77425	740060	77810	744801	6805SE	746634	G56612
740017	77455	740061	75676	744802	6826SE	746638	G56502
740018	77461	740062	77815	744803	6828SE	746641	G56516
740019	77479	740063	77817	744850	6801SE	746646	G56517
740020	77488	740064	77829	744851	6804SE	746648	G56648
740021	77489	740065	77905	744852	6803SE	746660	G55975
740022	77492	740066	77782	744853	6802SE	746661	G56501
740023	77524	740067	77377	744860	6827SE	746663	G55912
740024	77525	740068	77405	744881	6846SE	746664	G55913
740025	77607	740069	75795	744882	6847SE	746672	G56572
740026	77608	740070	75811	744883	6848SE	746674	G55974
740027	77609	740088	77837	744884	6849SE	746675	G55920
740028	77614	740089	75755	744885	6850SE	746676	G55921
740029	77638	740090	77418	744886	6851SE	746677	G56508
740030	77660	740092	77183	744887	6852SE	746686	G56513
740031	77661	740093	77389	744888	6853SE	746688	G56512
740032	77662	740094	77623	744889	6854SE	746696	G55878

NÚMERO DE FABRICACIÓN VS GRC

No. DE FABRICACIÓN	No. GRC	No. DE FABRICACIÓN	No. GRC	No. DE FABRICACIÓN	No. GRC	No. DE FABRICACIÓN	No. GRC
746697	G55879	746956	G55667	747194	G55923	747922	G63445
746703	G55584	746959	G55670	747195	G55924	747923	G63446
746705	G55586	746960	G55671	747211	G44493	747924	G63447
746708	G55587	746961	G55672	747212	G44495	747925	G63611
746709	G55588	746962	G55673	747214	G44497	747926	G63615
746710	G55589	746987	G55675	747234	G56736	747927	G63616
746711	G55590	746988	G55676	747236	G56739	747928	G63617
746712	G55591	746994	G55679	747321	G55817	747930	G63623
746713	G55592	746995	G55680	747324	G55828	747931	G63625
746719	G55593	747001	G55518	747328	G55668	747932	G63640
746720	G55594	747006	G35098	747329	G55669	747933	G63671
746721	G55601	747007	G35098	747330	G55831	747934	G63673
746722	G55602	747019	G55681	747331	G55832	747935	G63674
746723	G55603	747048	G55685	747332	G55833	747937	G63676
746724	G55600	747066	G55724	747333	G55834	747938	G63678
746725	G55605	747068	G55692	747335	G55847	747939	G63679
746756	G55606	747069	G55693	747336	G55848	747940	G63626
746762	G55607	747093	G55991	747337	G55849	747940	G63683
746763	G55608	747110	G55697	747338	G55850	747942	G63689
746764	G55609	747111	G55698	747510	G63506	747944	G63692
746765	G55714	747112	G55914	747552	G63612	747955	G63707
746767	G55505	747114	G55901	747613	G63694	747956	G63708
746767	G55514	747116	G55903	747685	G63776	747958	G63710
746769	G55610	747117	G55904	747687	G63778	747960	G63712
746770	G55611	747120	G55999	747690	G63781	747962	G63714
746781	G55615	747122	G55909	747691	G63782	747963	G63715
746782	G55616	747123	G55910	747692	G63783	747964	G63716
746816	G55526	747124	G55911	747900	G63411	747968	G63720
746874	G55652	747136	G55923	747901	G63394	747969	G63721
746875	G55653	747137	G55924	747902	G63605	747970	G63722
746886	G56602	747138	G55925	747905	G63510	747974	G63726
746887	G56603	747139	G55926	747908	G63604	748123	69807
746888	G56604	747140	G55927	747909	G63603	748179	69861
746889	G56605	747141	G55928	747910	G63606	748180	69863
746907	G35066	747142	G55929	747912	G63187	748193	69877
746909	G55989	747143	G55930	747913	G63371	748194	69878
746910	G35066	747144	G55931	747914	G63675	748213	69891
746910	G55990	747145	G55932	747915	G63437	748223	69901
746950	G55661	747146	G55933	747916	G63438	748225	69903
746951	G55662	747147	G55934	747917	G63439	748252	69924
746952	G55663	747178	G55937	747918	G63440	748273	69945
746953	G55664	747179	G55938	747919	G63441	748274	69946
746954	G55665	747180	G55939	747920	G63443	748278	69950
746955	G55666	747193	G56606	747921	G63444	748279	69951

NÚMERO DE FABRICACIÓN VS GRC

No. DE FABRICACIÓN	No. GRC	No. DE FABRICACIÓN	No. GRC	No. DE FABRICACIÓN	No. GRC	No. DE FABRICACIÓN	No. GRC
748280	69952	748460	70001	748622	69677	750663	G63828
748284	69956	748461	70002	748626	69773	750664	G63832
748285	69957	748462	70003	748629	69858	750672	G63842
748301	69962	748463	70087	748632	69881	750673	G63837
748308	69966	748464	70005	748635	69884	750674	G63844
748329	G63949	748465	70006	748636	69885	750675	G63845
748338	69416	748466	70007	748638	69898	750681	G63848
748348	69450	748467	70009	748652	G63937	750693	G63905
748358	69462	748468	70010	748668	69998	750696	G63860
748360	69464	748469	70011	748676	69995	750698	G63862
748361	69465	748470	70012	748677	69996	750700	G63864
748365	69473	748471	70013	748680	69407	750701	G63865
748372	69900	748472	70014	748682	69417	750702	G63866
748373	69907	748473	70015	748685	69420	750703	G63958
748374	69909	748476	70018	748748	G63841	750704	G63867
748375	69813	748477	70019	748792	G63950	750705	G63868
748376	69782	748478	70020	749601	82601	750706	G63869
748381	70023	748481	70027	749602	82602	750707	G63870
748382	70024	748482	70028	749603	82603	750710	G63873
748429	69573	748484	70031	749607	82607	750712	G63875
748430	69574	748485	70032	749608	82608	750714	G63877
748431	69575	748486	70033	749609	82609	750715	G63878
748432	G63872	748487	70034	749610	82610	750716	G63879
748435	69579	748489	70036	749614	82614	750717	G63880
748436	69580	748490	70037	749615	82615	750718	G63881
748437	69581	748491	70038	749617	82617	750719	G63882
748438	69582	748492	70039	749618	82618	750720	G63883
748439	69583	748493	70040	750611	G63798	750721	G63884
748440	69584	748494	70041	750612	G63799	750722	G63885
748441	69585	748498	70045	750614	G63772	750725	G63886
748442	69586	748504	51294	750619	G63810	750726	G63887
748443	69577	748600	69820	750622	G63803	750727	G63888
748443	69587	748601	69811	750626	G63622	750728	G63889
748444	69588	748603	69661	750627	G63808	750729	G63890
748446	69589	748604	69645	750629	G63812	750730	G63891
748447	69590	748606	69808	750630	G63813	750731	G63892
748448	69591	748607	G63907	750631	G63610	750732	G63893
748449	69592	748608	G63900	750632	G63815	750733	G63894
748450	69593	748609	G63914	750634	G63817	750734	G63895
748451	69594	748611	69845	750635	G63609	750735	G63896
748452	69595	748612	G63928	750635	G63818	750736	G63897
748453	G63902	748613	G63929	849093	G63609	750737	G63898
748454	81478	748615	G63904	849093	G63818	750739	G63918
748459	70000	748617	69689	750658	G63829	750740	G63919

NÚMERO DE FABRICACIÓN VS GRC

No. DE FABRICACIÓN	No. GRC	No. DE FABRICACIÓN	No. GRC	No. DE FABRICACIÓN	No. GRC	No. DE FABRICACIÓN	No. GRC
750741	G63959	750905	G55800	751027	61540	751072	61616
750743	G63961	750906	G55715	751028	61543	751073	61624
750744	G63962	750908	G55729	751029	61544	751074	61625
750745	G63963	750912	G55780	751030	61545	751075	61626
750746	G63964	750914	G55725	751031	61546	751078	61632
750747	G63965	750915	G56506	751032	61547	751079	61633
750748	G63966	750916	G56514	751032	61655	751080	61634
750749	G63967	750922	G56515	751033	61549	751081	61635
750751	G63969	750923	G55891	751034	61552	751082	61637
750752	G63970	750929	G55881	751035	61553	751083	61638
750753	G63971	750930	G55882	751036	61555	751084	61641
750800	G55772	750931	G55883	751037	61557	751085	61643
750809	G55745	750932	G55884	751038	61559	751087	61646
750814	G55749	750938	G55890	751038	61627	751088	61647
750817	G55658	750995	G56520	751039	61560	751089	61649
750825	G55657	750999	G55896	751040	61561	751090	61650
750829	G55746	751000	61504	751041	61565	751091	61653
750834	G55710	751001	61505	751042	61568	751092	61654
750838	G55784	751002	61506	751043	61569	751094	61656
750839	G55785	751003	61507	751044	61573	751096	61658
750840	G55976	751004	61510	751044	61629	751097	61659
750841	G55977	751005	61511	751045	61575	751099	61662
750842	G55970	751008	61517	751047	61582	751100	61663
750843	G55971	751009	61518	751048	61584	751102	61542
750844	G55752	751010	61519	751051	61588	751103	61541
750852	G55733	751011	61520	751052	61589	751104	61551
750854	G55719	751012	61521	751053	61590	751105	61554
750857	G55892	751013	61523	751054	61593	751106	61558
750858	G55893	751014	61524	751055	61594	751107	61586
750859	G55894	751015	61525	751056	61595	751108	61592
750861	G55727	751016	61526	751057	61596	751109	61623
750864	G55706	751017	61528	751058	61597	751110	61642
750874	G55707	751018	61530	751059	61598	751113	61601
750876	G55712	751018	61657	751060	61599	751123	61665
750877	G55708	751019	61531	751061	61600	751124	61666
750878	G55801	751020	61532	751063	61607	751125	61667
750881	G55738	751021	61533	751064	61608	751126	61668
750883	G55737	751022	61534	751065	61609	751127	61669
750884	G55704	751023	61535	751066	61610	751128	61670
750886	G55732	751023	61664	751067	61611	751129	61671
750887	G55728	751024	61536	751068	61612	751130	61672
750888	G55731	751025	61538	751069	61613	751132	61674
750895	G55776	751025	61605	751070	61614	751134	61676
750899	G55722	751026	61539	751071	61615	751135	61777

NÚMERO DE FABRICACIÓN VS GRC

No. DE FABRICACIÓN	No. GRC	No. DE FABRICACIÓN	No. GRC	No. DE FABRICACIÓN	No. GRC	No. DE FABRICACIÓN	No. GRC
751137	61679	752613	G56534	752670	G56591	752780	G56536
751138	61680	752616	G56537	752671	G56592	752783	G56664
751139	61681	752617	G56538	752672	G56593	752786	G56667
751140	61682	752618	G56539	752673	G56595	752787	G56668
751141	61683	752619	G56540	752674	G56594	752788	G56669
751142	61684	752620	G56541	752675	G56596	752789	G56670
751143	61685	752621	G56542	752676	G56597	752790	G56671
751144	61686	752622	G56543	752677	G56598	752791	G56672
751145	61687	752623	G56544	752678	G56599	752792	G56673
751146	61688	752624	G56545	752679	G56600	752793	G56674
751148	61690	752625	G56546	752680	G56601	752794	G56675
751149	61691	752626	G56547	752728	G56615	752795	G56676
751150	61692	752627	G56548	752729	G56616	752796	G56677
751151	61693	752630	G56551	752740	G56618	752797	G56678
751152	61694	752631	G56552	752741	G56619	752798	G56679
751154	61696	752632	G56553	752742	G56620	752799	G56680
751155	61697	752633	G56554	752743	G56621	752800	G56681
751157	61699	752634	G56555	752744	G56622	752801	G56682
751158	61700	752635	G56556	752747	G56624	752802	G56683
751161	61703	752636	G56557	752748	G56625	752803	G56684
751162	61704	752637	G56558	752749	G56626	752804	G56685
751167	61709	752638	G56559	752750	G56627	752805	G56686
751168	61710	752640	G56561	752751	G56628	752806	G56687
751169	61711	752641	G56562	752752	G56629	752807	G56688
751170	61712	752644	G56565	752754	G56631	752808	G56689
751171	61713	752645	G56566	752755	G56632	752809	G56690
751172	61714	752647	G56568	752756	G56633	752810	G56691
751173	61715	752648	G56569	752757	G56634	752811	G56692
751174	61716	752649	G56570	752758	G56635	752812	G56693
751175	61717	752650	G56571	752759	G56636	752813	G56694
751176	61718	752652	G56573	752760	G56637	752819	G56740
751178	61720	752653	G56574	752763	G56640	736505	G56701
751190	61732	752654	G56575	752764	G56641	752820	G56741
751192	61734	752655	G56576	752765	G56642	752823	G56978
751543	61675	752656	G56577	752766	G56643	752822	G56979
752602	G56523	752658	G56580	752767	G56644	752824	G56999
752603	G56524	752659	G56579	752768	G56645	752827	G56748
752606	G56527	752660	G56581	752770	G56655	752828	G56749
752607	G56528	752661	G56582	752775	G56660	752831	G56712
752608	G56529	752664	G56585	752776	G56661	752833	G56742
752609	G56530	752665	G56586	752777	G56522	752834	G56982
752610	G56531	752666	G56587	752778	G56525	752835	G56983
752611	G56532	752667	G56588	752778	G56526	752840	G56721
752612	G56533	752668	G56589	752779	G56535	752841	G56722

NÚMERO DE FABRICACIÓN VS GRC

No. DE FABRICACIÓN	No. GRC	No. DE FABRICACIÓN	No. GRC	No. DE FABRICACIÓN	No. GRC	No. DE FABRICACIÓN	No. GRC
752842	G56728	752896	G56800	753106	G56894	753176	G52040
752843	G56729	752897	G56801	753107	G56895	753177	G52041
752844	G56730	752898	G56802	753108	G56896	753178	G52042
752845	G56731	752899	G56803	753109	G56897	753179	G52043
752846	G56732	752900	G56804	753110	G56898	753180	G52044
752847	G56733	752901	G56805	753111	G56899	753181	G52045
752848	G56734	752902	G56806	753112	G52000	753182	G52046
752849	G56735	752903	G56807	753113	G52001	753183	G52047
752850	G56758	752905	G56809	753114	G52002	753184	G52048
752851	G56759	752906	G56810	753115	G52003	753187	G52051
752852	G56760	752908	G56812	753116	G52004	753188	G52052
752853	G56761	752909	G56813	753117	G52005	753189	G52053
752854	G56762	752910	G56814	753118	G52006	753190	G52054
752855	G56763	752911	G56815	753119	G52007	753191	G52055
752856	G56764	752912	G56816	753120	G52008	753192	G52056
752857	G56765	752913	G56817	753121	G52009	753195	G55801
752858	G56766	752915	G56819	753123	G52011	753196	G55800
752859	G56767	752916	G56820	753132	G52013	753197	G52057
752860	G56768	752917	G56821	753133	G52014	753198	G52058
752861	G56769	752918	G56822	753134	G52015	753201	G52061
752862	G56770	753032	G56836	753135	G52016	753202	G52062
752863	G56771	753033	G56837	753153	G52017	753203	G52063
752864	G56772	753034	G56838	753154	G52018	753204	G52064
752865	G56773	753035	G56839	753155	G52019	753205	G52065
752866	G56774	753036	G56840	753156	G52020	753206	G52066
752869	G56775	753037	G56841	753157	G52021	753209	G52069
752870	G56776	753046	G56842	753158	G52022	753210	G52070
752872	G56778	753047	G56843	753159	G52023	753211	G52071
752877	G56781	753086	G56882	753160	G52024	753212	G52072
752878	G56782	753087	G56883	753161	G52025	753213	G52073
752880	G56784	753088	G56884	753162	G52026	753214	G52074
752881	G56785	753089	G56885	753163	G52027	753215	G52075
752882	G56786	753090	G56886	753164	G52028	753216	G52076
752883	G56787	753091	G56887	753165	G52029	753217	G52077
752886	G56790	753094	G56545	753166	G52030	753218	G52078
752887	G56791	753095	G56546	753167	G52031	753219	G52079
752888	G56792	753096	G56516	753168	G52032	753220	G52080
752889	G56793	753097	G56517	753169	G52033	753221	G52081
752890	G56794	753100	G56888	753170	G52034	753222	G52082
752891	G56795	753101	G56889	753171	G52035	753223	G52083
752892	G56796	753102	G56890	753172	G52036	753224	G52084
752893	G56797	753103	G56891	753173	G52037	753225	G52085
752894	G56798	753104	G56892	753174	G52038	753226	G52086
752895	G56799	753105	G56893	753175	G52039	753227	G52087

NÚMERO DE FABRICACIÓN VS GRC

No. DE FABRICACIÓN	No. GRC	No. DE FABRICACIÓN	No. GRC	No. DE FABRICACIÓN	No. GRC	No. DE FABRICACIÓN	No. GRC
753228	G52088	753291	G52151	753346	G52205	753420	G52278
753229	G52089	753292	G52152	753347	G52206	753421	G52279
753230	G52090	753293	G52153	753350	G52209	753422	G52280
753234	G52094	753294	G52154	753351	G52210	753423	G52281
753235	G52095	753295	G52155	753352	G52211	753424	G52282
753236	G52096	753296	G52156	753354	G52213	753425	G52283
753237	G52097	753297	G52157	753355	G52214	753435	G52293
753238	G52098	753298	G52158	753356	G52215	753436	G52294
753243	G52103	753299	G52159	753357	G52216	753437	G52295
753244	G52104	753300	G52160	753358	G52217	753439	G52297
753245	G52105	753301	G52161	753359	G52218	753440	G52298
753246	G52106	753302	G52162	753361	G52220	753441	G52299
753247	G52107	753303	G52163	753362	G52221	753442	G52300
753248	G52108	753304	G52164	753363	G52222	753443	G52301
753250	G52110	753305	G52165	753364	G52223	753453	G52311
753251	G52111	753306	G52166	753365	G52224	753454	G52312
753252	G52112	753307	G52167	753366	G52225	753455	G52313
753253	G52113	753308	G52168	753367	G52226	753456	G52314
753256	G52116	753309	G52169	753368	G52227	753458	G52316
753257	G52117	753310	G52170	753369	G52228	753471	G52329
753258	G52118	753311	G52171	753376	G52235	753472	G52330
753261	G52121	753312	G52172	753377	G52236	753473	G52331
753262	G52122	753313	G52173	753378	G52237	753474	G52332
753263	G52123	753314	G52174	753379	G52238	753477	G52335
753264	G52124	753315	G52175	753386	G52244	753478	G52336
753265	G52125	753316	G52176	753387	G52245	753481	G52339
753267	G52127	753318	G52178	753388	G52246	753482	G52340
753268	G52128	753319	G52179	753391	G52249	753483	G52341
753269	G52129	753320	G52180	753392	G52250	753484	G52342
753270	G52130	753321	G52181	753395	G52253	753486	G52344
753271	G52131	753322	G52182	753396	G52254	753487	G52345
753276	G52136	753323	G52183	753397	G52255	753488	G52346
753277	G52137	753324	G52184	753398	G52256	753489	G52347
753278	G52138	753325	G52185	753399	G52257	753490	G52348
753279	G52139	753327	G52187	753400	G52258	753491	G52349
753280	G52140	753328	G52188	753402	G52260	753493	G52351
753281	G52141	753334	G52193	753403	G52261	753494	G52352
753282	G52142	753335	G52194	753404	G52262	753495	G52353
753283	G52143	753340	G52199	753405	G52263	753496	G52354
753284	G52144	753341	G52200	753414	G52272	753497	G52355
753285	G52145	753342	G52201	753415	G52273	753498	G52356
753288	G52148	753343	G52202	753416	G52274	753518	61500
753289	G52149	753344	G52203	753417	G52275	753522	61501
753290	G52150	753345	G52204	753418	G52276	753525	61502

NÚMERO DE FABRICACIÓN VS GRC

No. DE FABRICACIÓN	No. GRC	No. DE FABRICACIÓN	No. GRC	No. DE FABRICACIÓN	No. GRC	No. DE FABRICACIÓN	No. GRC
753526	61503	754432	G52432	754595	G52595	759820	49235
753620	61508	754433	G52433	754600	G52600	763000	G55909
751006	61513	754435	G52435	754601	G52601	763003	G51871
753642	61509	754436	G52436	754622	G52622	763006	G51874
753680	61512	754437	G52437	754623	G52623	763007	G51875
753689	61516	754438	G52438	754624	G52624	763008	G51876
753695	61522	754439	G52439	754625	G52625	763009	G51877
754359	G52359	754440	G52440	754638	G52638	763010	G51878
754360	G52360	754447	G52447	754639	G52639	763011	G51879
754361	G52361	754448	G52448	754665	G52665	763012	G51880
754362	G52362	754449	G52449	754666	G52666	763013	G51881
754363	G52363	754450	G52450	754698	G52698	763014	G51882
754369	G52369	754451	G52451	754699	G52699	763015	G51883
754370	G52370	754452	G52452	754725	G52725	763016	G51884
754374	G52374	754453	G52453	754726	G52726	763017	G51885
754375	G52375	754454	G52454	754727	G52727	763018	G51886
754382	G52382	754459	G52459	754728	G52728	763019	G51887
754383	G52383	754460	G52460	754742	G52742	763020	G51888
754384	G52384	754485	G52485	754743	G52743	763021	G51889
754385	G52385	754486	G52486	754837	G52837	763022	G51890
754386	G52386	754491	G52491	754838	G52838	763023	G51891
754387	G52387	754492	G52492	754855	G52855	763024	G51892
754388	G52388	754494	G52494	754856	G52856	763036	G51904
754389	G52389	754495	G52495	754886	G52886	763037	G51905
754390	G52390	754502	G52502	754887	G52887	763039	G51894
754395	G52395	754503	G52503	754888	G52888	763040	G51895
754396	G52396	754507	G52507	754900	G52900	763044	G51896
754398	G52398	754508	G52508	755100	69787	763045	G51897
754399	G52399	754519	G52519	755101	69805	763046	G51898
754400	G52400	754520	G52520	755631	G56750	763047	G51899
754401	G52401	754522	G52522	755632	G56751	763050	G51900
754406	G52406	754523	G52523	755633	G56752	763051	G51901
754410	G52410	754524	G52524	755634	G56753	763054	G51906
754411	G52411	754525	G52525	755637	G56754	763055	G51907
754418	G52418	754528	G52528	755638	G56755	763056	G51908
754419	G52419	754529	G52529	755641	G56756	763057	G51909
754420	G52420	754585	G52585	755642	G56757	763059	G51911
754421	G52421	754586	G52586	756574	G56650	763063	G51915
754422	G52422	754587	G52587	758006	61529	763064	G51916
754423	G52423	754588	G52588	758080	61550	763065	G51917
754425	G52425	754589	G52589	758125	61556	763066	G51918
754426	G52426	754591	G52591	758215	61591	763067	G51919
754428	G52428	754592	G52592	758229	61606	763073	G51925
754429	G52429	754594	G52594	758274	61651	763074	G51926

NÚMERO DE FABRICACIÓN VS GRC

No. DE FABRICACIÓN	No. GRC	No. DE FABRICACIÓN	No. GRC	No. DE FABRICACIÓN	No. GRC	No. DE FABRICACIÓN	No. GRC
763075	G51927	772074	70074	781124	G511124	849057	G64057
763076	G51928	772077	70077	781130	G511130	849058	G64058
763078	G51930	772086	70086	781140	G511140	849059	G64059
763081	G51933	772087	70004	781141	G511141	849060	G64060
763082	G51934	772089	70089	849000	G64000	849061	G64061
763083	G51935	772095	70095	849001	G64001	849062	G64062
763084	G51936	772096	70096	849002	G64002	849063	G64063
763085	G51937	772098	70098	849003	G64003	849064	G64064
763094	G51946	772103	70103	849004	G64004	849068	G63884
763099	G51947	772105	70105	849005	G64005	849071	G64071
763100	G51948	772110	70110	849006	G64006	849072	G64072
763102	G51949	772118	70118	849007	G64007	849074	G64074
763113	G51960	781000	G511000	849008	G64008	849079	G64079
763114	G51961	781001	G511001	849009	G64009	849080	G64080
763121	G51966	781002	G511002	849010	G64010	849083	G64083
763123	G51969	781003	G511003	849011	G64011	849084	G64084
763125	G51971	781004	G511004	849012	G64012	849085	G64085
763126	G51972	781019	G511019	849013	G64013	849087	G64087
763133	G51975	781020	G511020	849014	G64014	849090	G64090
763134	G51976	781021	G511021	849015	G64015	849095	61611
763135	G51977	781030	G511030	849016	G64016	849096	G63714
763140	G51982	781031	G511031	849026	G64026	849105	G64105
763141	G51983	781032	G511032	849027	G64027	849107	G64107
763142	G51984	781037	G511037	849028	G64028	849111	G64111
763143	G51985	781040	G511040	849029	G64029	849114	G64114
763147	G51989	781041	G511041	849030	G64030	849121	G64121
763148	G51990	781042	G511042	849031	G64031	849126	G64163
763151	G51993	781043	G511043	849032	G64032	849128	G64128
763153	G51995	781044	G511044	849033	G64033	849129	G64129
764002	G244002	781057	G511057	849036	G64036	849130	G64130
772052	70052	781061	G511061	849037	G64037	849131	G64131
772053	70053	781062	G511062	849038	G64038	849140	G64140
772056	70056	781063	G511063	849040	G64040	849143	G64143
772057	70057	781066	G511066	849042	G64042	849144	G64144
772059	70059	781070	G511070	849043	G64043	849146	G64146
772060	70060	781072	G511072	849044	G64044	849154	G64154
772061	70061	781074	G511074	849046	G64046	849157	G64157
772063	70063	781076	G511076	849047	G64047	849164	G64164
772064	70064	781081	G511081	849048	G64048	849181	G64181
772065	70065	781102	G511102	849049	G64049	849182	G64182
772067	70067	781103	G511103	849050	G64050	849184	G64184
772068	70068	781119	G511119	849052	G64052	849185	G64185
772070	40025	781122	G511122	849053	G64053	411997005	142005
772073	70073	781123	G511123	849056	G64056	736513M	G56726

NÚMERO DE FABRICACIÓN VS GRC

No. DE FABRICACIÓN	No. GRC
739650MT	G57000
739670MT	G57178
739687MT	G57147
739690MT	G57148
739692MT	G57172
739693MT	G57173
752763MT	G57167
752764MT	G57168
752898MT	G57171
752908MT	G57141
753096MT	G57063
753097MT	G57064
753111MT	G57156
753116MT	G57204
753119MT	G57205
753161MT	G57142
753221MT	G57176
753222MT	G57177
753271MT	G57206
754536MT	G57165
754537MT	G57166
754538MT	G57157
754539MT	G57158
754546MT	G57163
754547MT	G57164
754552MT	G57161
754553MT	G57162
754558MT	G57202
754559MT	G57203
763048MT	G57123
763049MT	G57124
763095MT	G57133
763096MT	G57134
763119MT	G57159
763120MT	G57160

INTERCAMBIO LÍNEAS GRC

Ultra	MaxControl	LTV	ProGuard	Guardian Gas	Guardian Hidráulicos	Guardian Hidráulicos Reforzados
G64083			61674			
G64016			61720			
G64015			61718			
G64013			61716			
G64012			61715			
G64011	77948		61714			
G64010			61713			
G64009			61712			
G64008			61711			
G64003			61704			
G64002			61703			
G63971			61710			
G63970	77950		61709			
G63969	77967					
G63967			61697			
G63966			61696			
G63963	77968					
G63963	77969					
G63959			61690			
G63958	77954			81933		
G63950			61556	81714		
G63949			61550			
G63937	77937		61606	81908		
G63915	77915		61512	81559		
G63914			61503			
G63909	77909		61508	81507		
G63908			61516	81113		
G63907	77907		61500	81147	42973	70163
G63906			61522	81496		
G63905	77905		61601	81836		
G63903	77903		61509	81541		
G63902	77902		61501	81478	42972	70161
G63898			61688			
G63897			61687			
G63896			61565			
G63895			61685			
G63894			61684			
G63893			61683			
G63888	77952		61682			
G63887			61681			
G63886	77951		61680			
G63881	77958		61679	81902		
G63868			61777			
G63866	77953	58930	61675	81930		
G63860			61651			
G63848	77947			81932		

INTERCAMBIO LÍNEAS GRC

Ultra	MaxControl	LTV	ProGuard	Guardian Gas	Guardian Hidráulicos	Guardian Hidráulicos Reforzados
G63847	77847		61664	81869		
G63842			61717			
G63841					42953	
G63837	77837					
G63829	77829		61676	81926		
G63817	77817	58817	61663	81925		
G63815	77815					
G63813			61662			
G63812		58812				
G63811			61657			
G63810	77810	58810	61656			
G63809	77809	58809	61655			
G63808	77808	58808	61654			
G63803	77803	58803	61643	81922		
G63799			61560			
G63798			61549	81675		
G63783	77783	58783	61641	81920		
G63782	77782					
G63781	77781					
G63778	77778	58778	61638	81892		
G63776			61659	81924		
G63775	77524		61629	81918		
G63773			61627	81917		
G63772	77772		61626	81916		
G63726	77726					
G63722			61616	81929		
G63721			61615	81936		
G63717	77717	58717	61614			
G63716	77716	58716	61613	81914		
G63715	77715	58715	61612	81913		
G63714	77714	58714	61611	81912		
G63712			61609			
G63710			61610	81911		
G63708			61608			
G63707			61607			
G63690			61605	81878		
G63683	77683		61575	81891		
G63679	77679		61624	81890		
G63678	77678		61623	81893		
G63676			61625	81882		
G63675	77412	58412	61642	81921		
G63675	77675	58675	61642	81921		
G63674	77674	58674	61635			
G63673	77673	58673	61634			
G63662	77662	58662	61600	81873		
G63661	77661	58661	61599	81928		

INTERCAMBIO LÍNEAS GRC

Ultra	MaxControl	LTV	ProGuard	Guardian Gas	Guardian Hidráulicos	Guardian Hidráulicos Reforzados
G63660	77660		61582			
G63640			61598			
G63639			61597			
G63638	77638	58638	61565	81789		
G63635			61596			
G63624			61595	81833		
G63623	77623	58623	61646	81828		
G63622	77608	58929	61591	81744		
G63622	77614	58622	61591	81744		
G63622	77807	58807				
G63621			61569	81826		
G63620			61594			
G63614	77614	58929	61561	81744		
G63612			61545			
G63611				81872		
G63610			61592	81937		
G63609	77609	58609	61542	81726		
G63608	77608	58929	61591	81744		
G63607	77607					
G63606			61589			
G63604			61568			
G63548			61588			
G63525	77525		61559	81730		
G63524			61573			
G63511			61551			
G63502			61557	81727		
G63500		58500	61553	81694		
G63499			61584	81837		
G63495	77904			81553		
G63494	77494		61510	81871		
G63492	77492		61506	81318		
G63491			61505	81097	42970	70162
G63490			61541	81583		
G63489	77489	58489	61544	81668		70164
G63488	77488	58488	61543	81667		
G63484			61513	81542		
G63461	77461	58461	61530	81510		
G63460			61511	81560		
G63457			61540	81582		
G63456	77456	58456				
G63455	77455	58455	61614	81821	42952	
G63454	77454		61539	81581		
G63437			61516	81113		
G63432			61507			
G63427			61533	81539		
G63426			61538	81529		

INTERCAMBIO LÍNEAS GRC

Ultra	MaxControl	LTV	ProGuard	Guardian Gas	Guardian Hidráulicos	Guardian Hidráulicos Reforzados
G63425	77425		61536	81549		
G63424	77424		61535	81548		
G63423	77423	58423	61531	81516		
G63422	77422	58422	61528	81482	42968	70173
G63421	77421	58421	61504	81750	42969	70171
G63420			61534	81540		
G63419			61532	81538		
G63418	77418		61529			
G63416		58416				
G63414	77414	58414	61520	81490	42967	70159
G63413	77413	58413	61522	81496		
G63410	77410	58410	61546			
G63409	77409	58409	61554	81710	42966	70160
G63406	77406	58406	61547	81082		
G63405	77405		61500	81147		
G63403	77403	58403	61658	81923		
G63394		58394				
G63389	77389	58389	61633	81342		
G63387		58387	61647	81285		
G63386		58386	61521	81394	42965	70169
G63377	77377	58377	61519	81484	42964	70172
G63375	77375		61555	81713		
G63366		58366	61649	81174		
G63360		58360	61650	81834	42963	70176
G63359	77359	58359	61523	81096		
G63357	77357	58357	61517	81108		
G63355	77355	58355	61525	81039	42961	
G63353		58353	61526	81091	42960	70167
G63350		58350	61518	81242	42959	70170
G63349	77349	58349	61524	81164	42958	70165
G63347			61516	81113		
G63306				82006		
G63299			61637			
G63183	77183	58183	61632	81825	42957	70175
G55977					55977	
G55976					55976	
G55746					55746	
G55745					55745	
G55713					55713	
G55658					55658	
G55657					55657	
G55526					55526	
G55514					55514	
G51888	79901					
G51887	79900					
G51294					51294	

INTERCAMBIO LÍNEAS GRC

Ultra	MaxControl	LTV	ProGuard	Guardian Gas	Guardian Hidráulicos	Guardian Hidráulicos Reforzados
G51022					51022	
G51006					51006	
G44902					44902	
G44763					44763	
G35098					56630	
G35066					55991	
69962				81927		
69945				81934		
69898	75898			81794		
69845				81795		
69820				81881		
69811	75811			81792		
69808				81793		
69795	75795			81791		
69756				81693		
69755	75755			81674		
69749				81530		
69733				81450		
69726					42520	
69724				81514		
69723				81517	42517	
69713				81416		
69709				81461		
69706				81445		
69704				81406		
69703				81338		
69689				81464		
69676	75676			81481		
69675				81446		
69633				81460		
69632				81459	42459	
69624				81095		
69622				81880		
69600				81494		
69574	77955					
69464				81935		
69407				81790		
	77479		61552	81870		
					42971	70168
				82001	42094	
				82005	42161	
				81508	42508	
			61590	81823		
			61691	81931		

INTERCAMBIO BOGE VS GRC

BOGE	GRC
22003	14004
22003	14005
32001	81076
32001	82104
32002	81270
32002	82004
32003	81491
32003	82126
32022	82130
32025	42494
32025	69600
32025	82129
32025	G63621
32031	70159
32034	42094
32036	61502
32036	82125
32051	81340
32054	42962
32056	42960
32057	G63841
32058	42952
32067	82128
32074	81703
32075	82002
32090	69703
32090	81338
32091	69704
32091	81153
32091	81406
32141	42161
32161	51006
32161	G51006
32163	81438
32194	42970
32219	42972
32219	70161
32221	42459
32231	G51017
32234	69709
32236	42508
32237	51022
32244	42517
32244	G63914
32257	42530
32272	81446

BOGE	GRC
32276	42446
32276	81713
32277	81495
32279	42972
32279	70161
32280	42973
32280	70163
32287	42971
32288	42965
32289	42967
32289	58410
32289	77410
32289	G63446
32289	G63511
32289	40026
32290	42966
32290	40027
32291	42520
32292	42961
32293	42958
32294	51091
32295	G55825
32305	81507
32369	51294
32382	61674
32382	G64083
32449	42953
32472	40025
32472	42956
32473	42955
32482	42954
32504	G63909
32505	G63949
33001	58355
33001	58625
33001	6802SE
33001	6852SE
33001	G63625
33002	6846SE
33002	6847SE
33005	6804SE
35016	70168
35016	70169
35020	42964
35020	70160
35020	81538

BOGE	GRC
35038	58438
35038	70165
35039	58355
35039	61525
35039	77355
35039	81039
35039	G63355
35053	58414
35053	82033
35053	G63447
35054	58456
35054	81540
35059	61510
35059	81871
35059	G63494
35063	58377
35063	61541
35063	70172
35063	77377
35063	77406
35063	81583
35063	G63377
35063	G63490
35063	G63928
35074	70167
35075	42963
35075	70176
35084	61633
35084	81342
35084	G63389
35085	58183
35085	61632
35085	81825
35085	G63183
35087	42957
35087	61670
35087	70175
35087	77183
35087	81898
35087	82046
35087	82054
35087	82065
35090	70166
35091	58489
35091	61544
35091	77489

BOGE	GRC
35091	81668
35091	G63489
35096	42969
35096	70171
35097	42968
35097	58349
35097	58422
35097	70173
35115	42959
35115	58623
35115	70170
35115	81242
35210	42577
35257	58423
35257	58609
35257	58906
35257	58908
35257	61531
35257	77609
35257	81496
35257	81516
35257	G63609
35257	G63818
35257	G63906
35257	G63908
832025	61569
832025	69675
832025	81494
832025	81582
832025	81714
832025	81750
832025	81826
832025	G63444
832025	G63950
832034	82001
832034	82032
832051	61545
832051	G44898
832051	G44926
832051	G44938
832051	G63612
832051	G63900
832057	81821
832057	G63455
832141	82005
832154	69465

INTERCAMBIO BOGE VS GRC

BOGE	GRC
832182	69606
832182	81514
832194	81097
832221	69632
832221	81459
832237	G51022
832244	61503
832244	69723
832244	81517
832244	G55817
832244	G56708
832257	69749
832257	81530
832271	69820
832271	69845
832271	81795
832271	81881
832276	61529
832276	69625
832276	77375
832276	77418
832276	77903
832276	81446
832276	81541
832276	81870
832276	G63418
832277	69574
832277	69575
832277	69633
832277	77955
832277	81460
832277	81461
832277	81495
832279	61501
832279	81478
832279	G63902
832280	81147
832286	81794
832291	69584
832291	69726
832294	G51022
832295	G55825
832322	G51230
832369	G51294
832369	G51895
832370	G51087

BOGE	GRC
832385	70019
832386	G51801
832387	G51800
832387	G51946
832395	69464
832395	81935
832419	61666
832419	81894
832430	69945
832430	81934
832438	61659
832438	61777
832438	81924
832454	G51279
832471	69573
832478	69579
832478	69588
832480	G51706
832481	G51735
832483	69582
832484	69581
832496	G51730
832498	69473
832511	69583
832512	G51100
832513	69946
832514	69683
832514	69725
832518	69878
832521	69956
832522	69957
832528	69863
832529	G51216
832532	G51881
832533	70005
832534	69924
832536	70007
832537	70002
832538	70004
832540	69877
832542	G51799
832543	70057
832545	69584
832546	69589
832547	70012
832549	70006

BOGE	GRC
832553	G51736
832553	G51768
832556	G51841
832558	69586
832560	G51721
832564	70031
832566	79900
832566	79901
832566	G51887
832566	G51888
832568	69592
832568	69898
832568	75898
832570	G51904
832572	G51871
832578	G51969
832579	G51712
832580	G51725
832585	G51885
832586	70039
832587	70040
832590	G51842
832591	G51849
832592	G51849
832593	G51731
832594	G51874
832595	70027
832600	G64064
832601	70041
832602	70060
832602	G51905
832603	G51747
832604	70036
832606	G51794
832607	G64062
832608	70003
832609	69591
832610	69587
832611	70014
832614	G51807
832615	G51783
832616	70011
832617	G511002
832618	G51863
832619	70089
832621	G51908

BOGE	GRC
832643	70092
832644	70093
832652	70092
832653	70094
832668	G511012
832673	G51934
832674	G51934
832678	G511072
832682	70061
832685	70056
832688	G511044
832692	70100
832694	G51971
832698	G51968
832705	G511041
832707	G511029
832710	G51990
835016	58416
835016	58500
835016	61521
835016	61553
835016	82012
835016	G63398
835016	G63416
835020	61500
835020	61506
835020	61532
835020	61568
835020	61649
835020	77907
835020	G63419
835020	G63443
835020	G63604
835038	61524
835038	77492
835039	58355
835039	61525
835039	77355
835039	81039
835039	G63355
835053	58350
835053	58386
835053	58455
835053	61520
835053	61546
835053	61551

INTERCAMBIO BOGE VS GRC

BOGE	GRC
835053	61561
835053	77414
835053	77455
835053	81394
835053	81490
835053	81553
835053	81744
835053	G63187
835053	G63386
835053	G63396
835053	G63495
835053	G63603
835054	58406
835054	58409
835054	58461
835054	61518
835054	61530
835054	61533
835054	61534
835054	61547
835054	61554
835054	61559
835054	61573
835054	61654
835054	61681
835054	61713
835054	77409
835054	77456
835054	77461
835054	77525
835054	81082
835054	81510
835054	81539
835054	81710
835054	81730
835054	81905
835054	G63420
835054	G63427
835054	G63439
835054	G63445
835054	G63456
835054	G63461
835054	G63524
835054	G63525
835054	G63887
835054	G63964

BOGE	GRC
835054	G64010
835074	58353
835074	61526
835090	58359
835090	58360
835090	61523
835090	61650
835090	61668
835090	77359
835090	81096
835090	81694
835090	81834
835090	81896
835090	G63360
835090	G63500
835091	58489
835091	61544
835091	61555
835091	77489
835091	81668
835091	G63375
835091	G63489
835092	61543
835092	81667
835093	61565
835093	81789
835096	58421
835096	61504
835097	61528
835097	61686
835097	61687
835097	61688
835097	77349
835097	81164
835097	81482
835099	61599
835100	61642
835100	61691
835100	81873
835101	58673
835101	61634
835101	61635
835101	81919
835101	81932
835104	61535
835104	61615

BOGE	GRC
835104	81869
835104	81936
835105	61575
835105	61664
835105	61676
835105	61715
835105	81891
835106	61538
835106	61557
835106	61605
835106	81529
835106	81727
835106	81878
835106	G63502
835107	58622
835107	58807
835107	58929
835107	61591
835107	77608
835107	77614
835107	77807
835107	81744
835107	G63622
835107	G63929
835115	58387
835115	58624
835115	61595
835115	61646
835115	61647
835115	77623
835115	81285
835115	81828
835115	81833
835115	G63350
835115	G63387
835115	G63441
835115	G63623
835115	G63624
835120	58357
835120	61517
835120	77357
835120	81108
835120	82062
835120	G63357
835121	58413
835121	58638

BOGE	GRC
835121	61516
835121	61519
835121	61522
835121	61539
835121	61665
835121	77413
835121	77454
835121	81484
835121	81581
835121	81900
835121	G63454
835121	G63671
835182	61623
835182	61626
835182	77678
835182	81893
835182	81916
835183	61624
835183	77607
835183	81890
835183	G63607
835184	58714
835184	58716
835184	58808
835184	61611
835184	77714
835184	81912
835185	61614
835187	58715
835187	58778
835187	61612
835187	61638
835187	81892
835187	81913
835189	61627
835189	61629
835189	81918
835190	61653
835190	61680
835190	77809
835190	77837
835190	77951
835190	G63809
835190	G63837
835190	G63886
835194	61625

INTERCAMBIO BOGE VS GRC

BOGE	GRC
835195	61601
835196	61658
835196	81923
835206	58783
835206	58817
835206	61641
835206	61663
835206	77783
835206	81920
835206	81925
835211	61709
835211	61710
835214	61657
835222	61512
835222	61540
835222	G63457
835227	61507
835227	61552
835227	G44800
835227	G63479
835227	G63903
835231	61613
835231	81914
835232	G63608
835233	61590
835233	81823
835234	81318
835235	61637
835236	61662
835237	61655
835237	G63716
835238	58810
835238	61656
835239	69580
835241	58662
835241	61600
835248	58661
835248	81928
835249	61692
835249	61710
930001	G63915
930002	G63403
930003	77675
930003	G63413
930003	G63662
930004	58675

BOGE	GRC
930004	77949
930004	77950
930004	G63970
930004	G63971
930006	G63353
930007	77847
930007	G63424
930007	G63721
930007	G63847
930008	77683
930008	77829
930008	81926
930008	G63626
930008	G63683
930008	G63829
930009	61616
930009	81929
930009	G63425
930009	G63722
930009	77979
930010	G51728
930011	G63844
930012	77661
930012	77954
930012	G63958
930012	G64009
930013	61716
930013	G63962
930013	G64013
930016	G63426
930016	G63690
930017	G63714
930018	58717
930018	77717
930018	G63717
930019	77772
930019	G63678
930019	G63772
930020	77679
930020	G63679
930022	77715
930022	77778
930022	77808
930022	G63715
930022	G63778
930022	G63808

BOGE	GRC
930023	G63406
930023	G63409
930023	G63414
930024	58809
930025	G63716
930026	77810
930026	G63810
930028	77524
930028	G63773
930029	81882
930029	G63676
930029	G63873
930030	77421
930030	77423
930030	G63421
930030	G63423
930031	77422
930031	G63422
930031	G63896
930031	G63897
930031	G63898
930032	G63349
930032	G63488
930033	58812
930033	77948
930033	G63812
930033	G63894
930033	G63895
930034	58488
930034	77488
930035	G63675
930037	77638
930037	G63638
930038	G63902
930040	58803
930040	61643
930040	77803
930040	81922
930040	G63803
930041	61675
930041	77953
930041	G63866
930041	77976
930042	G63776
930042	G63868
930042	G63869

BOGE	GRC
930043	G63907
930044	G51766
930044	G63813
930045	G63492
930045	G64031
930046	77905
930046	81836
930046	G63905
930048	G63359
930048	G63661
930049	58674
930049	77673
930049	77674
930049	77947
930049	77967
930049	G63673
930049	G63674
930049	G63848
930049	G63969
930049	58944
930050	G63410
930050	G63614
930051	58811
930051	77968
930051	77969
930051	G63811
930051	G63963
930051	58945
930052	77817
930052	G63783
930052	G63817
930053	G63355
930054	G51703
930055	G63870
930056	G51704
930057	G63867
930058	G51719
930059	G51720
930060	G51729
930063	G63918
930063	G63919
930065	G64027
930066	G64028
930068	G51804
930068	G51805
930069	G64046

INTERCAMBIO BOGE VS GRC

BOGE	GRC
930072	69900
930072	G63862
930072	G64047
930073	61717
930073	G63842
930073	G64014
930074	61560
930074	81904
930074	G63799
930075	61718
930075	G64015
930077	61704
930077	69909
930077	70010
930077	G63877
930077	G64003
930078	G51286
930079	G64000
930081	G64001
930083	G63965
930084	G56807
930085	G64012
930089	G63845
930089	G64033
930090	61609
930090	G63712
930091	G63878
930091	G63883
930095	G51798
930095	G51884
930105	61720
930105	G63892
930106	G64016
930107	G63890
930107	G63891
930109	G51724
930109	G51837
930110	G51723
930110	G51836
930113	G63879
930114	G63884
930117	G63875
930120	G51715
930130	G63299
930132	G63690
930133	81917

BOGE	GRC
930133	G63775
930134	G64057
930135	69813
930135	G63860
930141	G52205
930141	G56838
930142	G52206
930142	G56839
930143	G64037
930144	G51853
930144	G51854
930145	G63889
930145	G64007
930146	61714
930146	G51856
930146	G64011
930148	G51838
930150	69582
930150	G64090
930151	G51879
930153	70034
930155	61690
930155	G63959
930157	G64058
930158	G64059
930159	G64026
930160	G51848
930161	G64056
930162	G64063
930163	G64050
930164	G64091
930165	G64089
930166	G511004
930166	G511085
930167	G51993
930178	70087
950001	G55525
950002	G55697
950003	G56620
950004	G55685
950005	G55834
950005	G55948
950006	G56778
950007	G56655
950010	G56581
950011	G56582

BOGE	GRC
950012	G52106
950012	G52108
950012	G56797
950013	G52105
950013	G52107
950013	G56798
950017	G56601
950018	G56568
950020	G51718
950021	G52637
950022	G52636
950023	G56518
950024	G52127
950024	G52128
950024	G56773
950024	G56774
950026	G56758
950027	G56759
950028	G56799
950029	G56800
950030	G52031
950030	G56558
950031	G52030
950031	G56559
950035	G56615
950036	G56616
950037	G56739
950038	G56736
950045	G52008
950045	G52170
950046	G51739
950047	G63885
950047	G64029
950047	G64030
950050	G52145
950051	G52639
950052	G52638
950053	G55921
950054	G55920
950055	G52009
950055	G52171
950056	G52001
950057	G52000
950058	G52003
950059	G52002
950060	G51850

BOGE	GRC
950060	G64053
950061	G52144
950062	G56518
950063	G51894
950064	G56841
950065	G56840
950066	G52065
950067	69581
950068	G52188
950069	G52187
950070	G51815
950073	G52199
950074	G52200
950077	G51870
950077	G51891
950077	G57000
950078	G52007
950079	G52004
950080	G52149
950081	G52148
950082	G52210
950083	G52209
950084	G52220
950085	G52173
950086	G52174
950088	G52300
950089	G52299
930 040	58803
930 041	58930
930 041	61675
930 041	77953
930 041	G63866
930 041	G64101
930 053	77355
930 170	G51928
930 007	G63424
930 017	77716
930 023	G63409
930 040	61643
930 040	77803
930 040	81922
930 040	81930
930 040	G63803
930 089	G64033
930 109	G51724
950 071	G52295

INTERCAMBIO BOGE VS GRC

BOGE	GRC
950 087	G52341
950 087	G52343
950 093	G52348
950 094	G52349
950 095	G52301
950 035	G56615
950 036	G56616
950 037	G56739
950 038	G56736
950 045	G52008
950 055	G52009
950 056	G52001
950 059	G52002
CR221	44763
CR221	G44763
CR250	G44774
CR273	44902
CR8273	G44902
CR8283	G52626
MP008	55514
MP009	G55551
MP009	G56504
MP013	G55511
MP020	55991
MP020	G55990
MP022	G56503
MP035	55526
MP042	G55708
MP053	55713
MP068	55745
MP069	55746
MP104	55658
MP105	55657
MP106	55976
MP107	55977
MP148	56630
MP289	56743
MP289	56744
MP307	56980
MP8008	G55505
MP8008	G55514
MP8008	G55992
MP8020	G35066
MP8020	G55989
MP8020	G55991
MP8035	G55526

BOGE	GRC
MP8043	G55722
MP8043	G55733
MP8045	G52053
MP8046	G52052
MP8073	G55714
MP8080	G56705
MP8081	G56706
MP8104	G55658
MP8105	G55657
MP8106	G55976
MP8107	G55977
MP8122	G55698
MP8136	G55509
MP8139	G55679
MP8140	G55680
MP8142	G55579
MP8143	G55847
MP8143	G56515
MP8143	G56801
MP8144	G55848
MP8145	G55692
MP8145	G56520
MP8146	G55693
MP8148	G35098
MP8166	G55912
MP8167	G55913
MP8168	G55909
MP8169	G55910
MP8170	G55877
MP8171	G55786
MP8173	G56649
MP8174	G56650
MP8175	G56712
MP8176	G56748
MP8177	G55667
MP8177	G55833
MP8178	G55666
MP8178	G55832
MP8179	G55669
MP8180	G55668
MP8206	G55971
MP8207	G55970
MP8213	G55663
MP8214	G55664
MP8215	G55665
MP8215	G55856

BOGE	GRC
MP8220	G55616
MP8221	G55518
MP8225	G55697
MP8226	G55681
MP8226	G56790
MP8241	G56606
MP8251	G56618
MP8251	G56806
MP8252	G56619
MP8252	G56805
MP8259	G55892
MP8260	G55893
MP8260	G55894
MP8261	G56749
MP8262	G51733
MP8264	G56517
MP8265	G56516
MP8273	G55949
MP8275	G56501
MP8279	G55974
MP8283	G56742
MP8284	G55975
MP8287	G56983
MP8288	G56982
MP8291	G51295
MP8292	G52042
MP8294	G51267
MP8294	G51796
MP8294	G55818
MP8295	G51078
MP8295	G51254
MP8295	G51268
MP8297	G52041
MP8298	G56648
MP8303	G55978
MP8304	G55960
MP8305	G55901
MP8306	G52218
MP8306	G56999
MP8308	G56620
MP8311	G56693
MP8312	G56692
MP8319	G56740
MP8320	G56741
MP8321	G55896
MP8324	G55870

BOGE	GRC
MP8325	G55871
MP8334	G56978
MP8335	G56979
MP8338	G51097
MP8338	G51099
MP8342	G56607
MP8346	G56761
MP8347	G56760
MP8348	G56769
MP8357	G56895
MP8358	G56896
MP8359	G56897
MP8360	G56898
MP8365	G51740
MP8366	G56602
MP8366	G56604
MP8367	G56603
MP8367	G56605
MP8368	G56750
MP8368	G56752
MP8368	G56756
MP8369	G56751
MP8369	G56753
MP8369	G56757
MP8370	G56608
MP8374	G52165
MP8375	G52164
MP8376	G52044
MP8377	G52045
MP8379	G52590
MP8380	G52048
MP8382	G52040
MP8383	G52043
MP8387	G52028
MP8388	G52029
MP8389	G51737
MP8390	G56622
MP8391	G56621
MP8392	G56792
MP8394	G52215
MP8395	G52214
MP8398	G52011
MP8398	G56694
MP8402	G56722
MP8403	G56721
MP8404	G56729

INTERCAMBIO BOGE VS GRC

BOGE	GRC
MP8405	G56728
MP8406	G52013
MP8406	G56660
MP8407	G52014
MP8407	G56661
MP8414	G52080
MP8415	G52079
MP8417	G51738
MP8418	G51700
MP8418	G51716
MP8419	G56899
MP8420	G52137
MP8420	G52139
MP8421	G52136
MP8421	G52138
MP8427	G51746
MP8434	G56817
MP8451	G56635
MP8452	G56551
MP8459	G56683
MP8460	G56684
MP8461	G51727
MP8462	G56686
MP8463	G56685
MP8464	G52066
MP8466	G52176
MP8472	G56802
MP8474	G56672
MP8475	G56671
MP8477	G52175

BOGE	GRC
MP8480	G55999
MP8481	G55999
MP8482	G55662
MP8483	G55661
MP8484	G56552
MP8485	G56636
MP8489	G51761
MP8490	G51760
MP8495	G52081
MP8496	G52082
MP8497	G52225
MP8498	G52226
MP8499	G52121
MP8500	G52122
MP8501	G52094
MP8502	G52095
MP8505	G56677
MP8506	G56678
MP8520	G52194
MP8521	G52193
MP8522	G56883
MP8523	G56882
MP8524	G56885
MP8525	G56884
MP8526	G52153
MP8526	G52283
MP8527	G52152
MP8527	G52282
MP8528	G52155
MP8529	G52154

BOGE	GRC
MP8531	G56894
MP8532	G52217
MP8533	G52005
MP8534	G52006
MP8536	G56887
MP8537	G56886
MP8538	G56810
MP8539	G56810
MP8540	G52222
MP8541	G52221
MP8542	G52276
MP8545	G52624
MP8546	G52625
MP8549	G52075
MP8550	G52076
MP8551	G52021
MP8552	G52022
MP8553	G51810
MP8553	G51859
MP8553	G51896
MP8554	G51811
MP8554	G51859
MP8554	G51897
MP8555	G52038
MP8556	G52039
MP8557	G56842
MP8558	G56843
MP8559	G52211
MP8560	G52211
MP8561	G56836

BOGE	GRC
MP8562	G56837
MP8563	G52117
MP8564	G52118
MP8565	G52382
MP8566	G52383
MP8569	G52311
MP8572	G52263
MP8573	G52262
MP8576	G52521
MP8601	G511010
MP8602	G511011
MP8611	G52297
MP8612	G52298
MP8613	G52585
MP8620	G52275
MP8621	G52274
MP8622	G52676
MP8623	G52675
MP8624	G52699
MP8625	G52698
MP8626	G52529
MP8627	G52528
MP8632	G511028
MP8633	G511027
MP8635	G51984
MP8636	G51985
MP8645	G52433
MP8646	G52432
MP8657	G51915

INTERCAMBIO CONDUMEX VS GRC

CONDUMEX	GRC
15055	14004
15067	14004
15080	81795
15081	6807SE
15500	6802SE
15501	6804SE
15501	6846SE
15502	6804SE
15502	6852SE
15502	6859SE
15504	14071
15504	6801SE

CONDUMEX	GRC
15506	6860SE
30201	51006
30201	G51006
30202	51017
30203	51022
30205	G51294
30210	51294
30211	G51735
30212	G51230
30213	70007
30213	G51735
30215	70019

CONDUMEX	GRC
30216	G51279
30218	70007
30219	70007
39155	49155
39155	70165
39205	49205
39218	49231
39222	49222
39569	49369
43003	42958
43003	61524
43003	70165

CONDUMEX	GRC
43003	81164
43003	G63349
43004	61649
43004	81174
43004	G63366
43014	81340
43019	81492
43022	42954
43025	61519
43025	81484
43025	G63377
43026	61550

INTERCAMBIO CONDUMEX VS GRC

CONDUMEX	GRC
43026	81676
43026	G63949
43031	42446
43031	42514
43031	69724
43037	81406
43039	42520
43039	69726
43040	61626
43040	G63772
43040	40026
43041	40027
43045	42972
43045	61501
43045	81478
43045	G63902
43046	42973
43046	61500
43046	81147
43046	G63907
43047	81460
43048	81338
43052	81501
43053	81446
43054	81495
43055	81494
43057	G55825
43058	81884
43059	61500
43059	81147
43059	G63907
43060	69464
43061	69723
43062	G51706
43063	81461
43070	42967
43070	61520
43070	81490
43070	G63414
43092	81459
43098	69945
43119	61600
43119	G63662
43120	61641
43120	G63783
43121	81920

CONDUMEX	GRC
43122	61600
43122	81873
43122	G63662
43123	42577
43124	61500
43124	70163
43124	81147
43124	G63907
43125	61520
43125	70159
43125	81490
43125	G63414
43127	G51731
43131	42955
43132	61554
43132	81710
43132	G63409
43133	61554
43133	69580
43133	70160
43133	81710
43134	G63909
43135	G63949
43141	G64064
43142	G51747
43150	42508
43150	81508
43151	81703
43154	42459
43154	69632
43156	G63907
43157	G63389
43158	G63183
43171	82090
43172	81469
43236	61524
43236	81164
43236	G63349
43381	42952
43381	61521
43381	81394
43381	G63386
43387	81076
43440	82130
43453	42962
43454	42970

CONDUMEX	GRC
43454	61505
43454	70163
43454	81097
43454	G63491
43455	42972
43455	61501
43455	70161
43455	81478
43455	G63902
43511	42963
43511	61526
43511	81091
43511	G63353
43512	42960
43512	61526
43512	70167
43512	81091
43512	G63353
43725	42161
43725	82005
43728	42094
43728	82001
43730	42953
43730	G63841
43731	42952
43731	61614
43731	81821
43731	G63455
43734	42161
43734	82005
43736	42094
43736	82001
43982	42530
43982	69749
53002	81446
53004	42958
53004	61649
53004	81174
53004	G63366
53008	G63929
53009	G63624
53016	G63773
53017	G63772
53020	61521
53020	81394
53020	81744

CONDUMEX	GRC
53020	G63386
53021	G63623
53022	61504
53022	81750
53022	G63421
53023	61528
53023	81482
53023	G63422
53025	61521
53025	81394
53025	G63386
53028	G63489
53029	61544
53029	81668
53029	G63489
53030	81894
53031	G63502
53032	81495
53035	G63488
53036	61526
53036	81091
53036	G63353
53037	61565
53037	81789
53037	G63638
53051	42967
53051	61520
53051	81490
53051	G63414
53052	42966
53052	61530
53052	81510
53052	G63461
53053	G63386
53057	G63359
53058	G63353
53060	81935
53070	61520
53070	81490
53070	81913
53070	G63414
53071	42964
53071	61519
53071	81484
53071	G63377
53072	81925

INTERCAMBIO CONDUMEX VS GRC

CONDUMEX	GRC	CONDUMEX	GRC	CONDUMEX	GRC	CONDUMEX	GRC
53073	81930	58070	61520	69034	69909	69101	G55877
53195	G63183	58070	81490	69035	69588	69105	70087
53271	G63673	58070	G63409	69036	69900	69106	70004
53272	G63662	58178	61500	69037	69924	69107	70003
53273	G63674	58178	81147	69038	G51700	69108	G64003
53274	G63675	58178	G63907	69038	G51716	69109	70036
53275	G63661	58337	58489	69040	61506	69110	G51805
53337	61544	58337	61544	69040	81318	69112	G51800
53337	81668	58337	81668	69040	G63492	69114	70027
53337	G63489	58337	G63489	69041	61662	69115	70041
53338	82003	58341	61521	69041	G63813	69116	G51783
53341	61521	58341	81394	69042	61662	69118	70009
53341	81394	58341	G63386	69042	G63813	69119	G51738
53341	G63386	58400	G63359	69043	61506	69123	69591
53400	61523	58401	G63353	69043	81318	69128	70015
53400	81096	58402	58353	69043	G63492	69200	G51006
53400	G63359	69010	69898	69044	69465	69201	G51017
53401	61526	69011	61600	69045	G51736	69202	G51022
53401	70167	69011	G63662	69046	G63845	69203	G51022
53401	81091	69012	61641	69047	G51725	69204	G51294
53401	G63353	69012	G63783	69048	G63909	69205	G51735
53402	G63360	69013	61641	69048	G64001	69226	69945
58003	58349	69013	81920	69049	G63949	69227	G51230
58003	61524	69013	G63783	69049	G63965	69228	G51294
58003	81164	69014	61600	69076	G64064	69229	G51733
58003	G63349	69014	81873	69079	70002	69230	G56712
58004	58366	69014	G63662	69080	61506	69231	70007
58004	61649	69015	69464	69080	81318	69233	G51295
58004	81174	69017	G63409	69080	G63492	69234	G51279
58004	G63366	69018	G63414	69081	G63712	69236	G51801
58035	58488	69020	G51706	69084	G51815	69239	G51730
58035	61543	69021	69584	69085	G63890	69240	70007
58035	81667	69022	69584	69086	G63890	69241	70007
58035	G63488	69023	69473	69087	G63877	69243	G64062
58044	69581	69024	61500	69088	69595	69300	G63349
58045	69582	69024	81478	69089	69594	69301	69573
58051	58410	69024	G63902	69090	G64031	69302	69726
58054	61530	69025	61501	69091	G51799	69309	58929
58054	81510	69025	81147	69094	G64058	69309	61520
58054	G63461	69025	G63907	69095	G64059	69309	61561
58069	58406	69026	40025	69098	69946	69309	81490
58069	58409	69026	42956	69098	G51742	69309	81744
58069	61547	69028	G55871	69100	61593	69309	G63614
58069	81082	69031	61528	69100	81872	69310	61533
58069	G63414	69031	G63422	69100	G63611	69310	81490
58070	58414	69032	70005	69101	G55821	69310	81744

INTERCAMBIO CONDUMEX VS GRC

CONDUMEX	GRC	CONDUMEX	GRC	CONDUMEX	GRC	CONDUMEX	GRC
69310	G63427	69382	81342	69523	G63489	69585	61720
69312	81492	69382	G63389	69534	G51815	69585	G64016
69320	69703	69383	61632	69535	G63891	69586	G63892
69320	81338	69383	81825	69536	G51815	69587	61709
69321	61500	69383	G63183	69537	G63844	69587	61710
69321	81147	69386	81693	69538	61683	69587	G63971
69321	G63907	69388	69749	69538	G63893	69588	G63970
69322	81446	69388	81530	69539	61684	69588	G63971
69323	69606	69391	81916	69539	G63894	69589	G63958
69323	81495	69392	81917	69541	G63867	69590	61615
69326	61500	69395	61520	69544	G63622	69590	G63721
69326	81147	69395	81490	69545	61595	69591	61616
69326	G63907	69395	G63414	69545	G63624	69591	G63722
69327	69723	69396	61547	69546	61591	69592	61714
69327	81517	69396	81082	69546	G63608	69592	G64011
69330	81710	69396	G63406	69547	61533	69593	61654
69330	G63409	69501	61543	69547	81539	69593	G63808
69334	82156	69501	G63488	69547	G63427	69594	61713
69346	61526	69502	G63424	69548	61520	69594	G64010
69346	81091	69503	61544	69548	61561	69596	70012
69346	G63353	69503	G63489	69548	81490	69600	69580
69347	G63355	69504	G63425	69548	81744	69601	61554
69355	61523	69505	61506	69548	G63614	69601	G63907
69355	61650	69505	61666	69549	58500	69605	G64015
69355	81096	69506	61523	69549	58929	69610	G63915
69355	81834	69506	G63359	69549	61553	69611	G63403
69355	G63359	69507	61526	69549	61591	69612	61535
69357	61526	69507	G63353	69549	81694	69612	G63424
69357	81091	69509	61554	69549	G63500	69613	G63683
69357	G63353	69509	G63409	69549	G63929	69615	G63678
69360	G63841	69510	61520	69550	61518	69616	G63607
69361	61614	69510	G63414	69550	61595	69617	61668
69361	G63455	69511	G63299	69550	81242	69618	61665
69369	81147	69513	61626	69550	G63350	69622	61642
69369	G63907	69513	G63772	69550	G63624	69622	G63675
69370	81478	69516	G63423	69554	61554	69623	61635
69370	G63902	69517	61528	69554	G63409	69623	G63674
69376	61667	69517	G63422	69555	G63714	69654	61659
69376	81478	69519	61599	69556	G63778	69654	G63776
69376	81884	69519	G63661	69557	G63662	69656	61512
69379	69632	69520	61544	69563	61634	69656	G63915
69379	81459	69520	G63489	69563	G63673	69657	61658
69381	61500	69521	61543	69582	G63848	69657	G63403
69381	81147	69521	G63488	69583	61692	69658	61504
69381	G63907	69522	G63638	69583	G63962	69658	G63421
69382	61633	69523	61544	69584	G64012	69660	G51728

INTERCAMBIO CONDUMEX VS GRC

CONDUMEX	GRC
69661	G63844
69662	69579
69663	61555
69663	G63375
69664	61565
69664	G63638
69666	61655
69666	G63809
69667	61657
69667	G63811
69668	G63918
69690	G63919
69692	61663
69692	G63817
69693	61675
69693	G63866
69801	G44763
69802	G44752
69803	G56504
69807	G44752
69807	G44934
69809	G44902
69810	G44902
69812	G44902
69814	G44774
69816	G55526
69817	G56504
69901	G56504
69904	G55507
69905	G55511
69906	G55505
69906	G55514
69907	G56503
69909	G55579
69951	G55708
69956	G55713
69961	G55616
69963	G55681
69965	G56705
69966	G56706
69967	G56649
69968	G56650
69978	G55657
69978	G55658
69979	G55745
69980	G56805

CONDUMEX	GRC
69980	G56806
69981	G55976
69981	G55977
69990	G55680
69991	G55679
69992	G35098
69998	G35066
69999	G35066
70001	G55834
70702	G55526
72005	G51798
72008	G64052
79002	G55818
79003	G51078
79006	G55970
79007	G55971
79053	G56606
79056	G55974
79057	G55975
79058	G55974
79059	G51254
79059	G51268
79060	G51267
79060	G56551
79060	G56552
79062	G56516
79063	G56742
79064	G55948
79065	G55949
79066	G56648
79067	G52225
79067	G56979
79068	G52226
79068	G56978
79069	G56999
79070	G55892
79071	G55893
79072	G55894
79073	G56983
79074	G56982
79077	G55896
79078	G55949
79080	G55870
79081	G56748
79082	G52044
79083	G52045

CONDUMEX	GRC
79085	G56694
79089	G56749
79090	G52042
79091	G52041
79094	G56692
79098	G56660
79099	G56661
79102	G55692
79103	G56778
79104	G56896
79105	G56895
79106	G56898
79107	G56897
79112	G56740
79113	G56741
79114	G52048
79115	G52048
79116	G55685
79117	G56620
79128	G56672
79129	G56671
79137	G52217
79140	G52040
79143	G56899
79147	G51743
79148	G51097
79149	G56882
79150	G56883
79151	G56884
79152	G56885
79153	G52005
79154	G52006
79155	G52214
79156	G52215
79158	G52043
79162	G52155
79163	G52154
79164	G56797
79165	G56798
79173	G52008
79174	G52009
79175	G52095
79176	G52094
79177	G52194
79178	G52193
79180	G51737

CONDUMEX	GRC
79188	G56843
79189	G56842
79190	G56758
79191	G56759
79199	G51811
79200	G51810
79201	G52185
79202	G52184
79203	G51859
79204	G51859
79210	G56773
79211	G56774
79215	G52224
79216	G52223
81740	61560
81740	81904
81740	G63799
83004	44763
83004	G44763
83007	G44752
83012	G44752
83016	44902
83016	G44902
83018	G44774
83023	G44902
83030	44902
85001	G55733
85002	G55714
85003	G55714
85004	G56606
85005	56980
85006	55713
85006	G55713
85029	55657
85029	55658
85029	G55657
85030	55746
85030	G55746
85031	55976
85031	55977
85031	G55976
85032	55991
85032	G35066
85035	G56705
85036	G56706
85037	G55698

INTERCAMBIO CONDUMEX VS GRC

CONDUMEX	GRC
85039	G56516
85040	G56517
85041	G56748
85043	G56648
85044	55991
85044	G55991
85047	G55970
85048	G55971
85049	G35066
85049	G56999
85050	G52052
85054	G52053
85060	G52048
85061	G52048
85064	G56887
86001	G56712
164022	43143
164023	43140
164028	43049
164031	43067
215508	G56504
215523	G56504
215524	G55507
215538	G55514
215540	G56503
215550	55526
215550	G55526
215551	G56504
638538	56630
638538	G35098
79095L	G56693
79095R	G56693
79183L	G52047
79183R	G52046
G44986	G44986
G51033	G51033
G55525	G55525
G55595	G55847
G55596	G55847
G55597	G55848
G55598	G55848
G55608	G55608
G55665	G55665
G55685	G55685
G55692	G55692
G55693	G55693

CONDUMEX	GRC
G55697	G55697
G56518	G56518
G63424	G63424
G63426	61538
G63426	81529
G63426	G63426
G63457	G63457
G63490	G63490
G63502	G63502
G63511	G63511
G63607	G63607
G63608	G63608
G63621	G63621
G63626	G63626
G63626	G63683
G63626	G63829
G63676	G63676
G63690	G63690
G63716	G63714
G63717	G63717
G69795	69795
GT30203	51022
GT30210	51294
GT43039	42520
GT638538	56630
GT83030	44902
GT83030	G44902
GT85029	55657
GT85029	55658
GT85029	55745
GT85031	55746
GT85031	55976
GT85031	55977
GT85032	55991
USA69011	G63662
USA69011	G63866
USA69012	G63783
USA69012	G63803
USA69013	61641
USA69013	81920
USA69014	61600
USA69014	81873
USA69014	G63662
USA69031	61528
USA69031	G63422
USA69033	61674

CONDUMEX	GRC
USA69033	G64083
USA69034	69909
USA69034	G63877
USA69079	70002
USA69080	61506
USA69080	81318
USA69080	G63492
USA69092	69813
USA69092	G63860
USA69112	G51800
USA69112	G51946
USA69115	70041
USA69117	61501
USA69117	81478
USA69117	G63902
USA69120	G51747
USA69121	70011
USA69131	G51874
USA69133	70073
USA69135	69592
USA69139	70063
USA69143	70074
USA69226	G51022
USA69228	G51895
USA69301	69573
USA69391	G63772
USA69392	G63773
USA69517	61528
USA69517	G63422
USA69522	61544
USA69522	G63489
USA69532	G63884
USA69538	61683
USA69538	G63893
USA69539	61684
USA69539	G63894
USA69544	G63622
USA69555	61611
USA69555	G63714
USA69556	G63717
USA69582	G63848
USA69583	61692
USA69583	G63962
USA69584	G64012
USA69585	61720
USA69585	G64016

CONDUMEX	GRC
USA69586	G63892
USA69587	61709
USA69587	61710
USA69587	G63971
USA69588	G63970
USA69588	G63971
USA69589	G63958
USA69592	61714
USA69592	G64011
USA69594	61713
USA69594	G64010
USA69600	69580
USA69601	61554
USA69601	G63907
USA69606	61605
USA69606	81878
USA69606	G63690
USA69612	61535
USA69612	61664
USA69612	G63424
USA69612	G63847
USA69613	61575
USA69613	61676
USA69613	G63626
USA69613	G63683
USA69613	G63829
USA69615	61623
USA69615	G63678
USA69616	61624
USA69616	G63679
USA69658	61504
USA69658	G63421
USA69660	G63844
USA69661	G51728
USA69664	61565
USA69664	G63638
USA69666	61655
USA69666	G63809
USA69667	61657
USA69667	G63811
USA69668	G63918
USA69690	G63919
USA69692	61663
USA69692	G63817
USA69693	61675
USA69693	G63866

INTERCAMBIO CONDUMEX VS GRC

CONDUMEX	GRC
USA69695	G64090
USA69696	G63862
USA69696	G64047
USA69697	G63676
USA69699	61500
USA69699	G63907
USA69967	G56649
USA69968	G56650
USA72001	G63870
USA72002	61535
USA72002	G63424
USA72003	61575
USA72003	G63683
USA72004	G64026
USA72006	G64003
USA72010	G64061
USA72017	G64130
USA79053	G56606
USA79067	G56979
USA79068	G56978
USA79089	G56749
USA79091	G52041

CONDUMEX	GRC
USA79092	G56568
USA79093	G56601
USA79100	G56558
USA79101	G56559
USA79103	G56778
USA79115	G52218
USA79116	G55685
USA79117	G56620
USA79120	G52001
USA79121	G52000
USA79122	G52003
USA79123	G52002
USA79132	G56778
USA79140	G52040
USA79166	G56581
USA79167	G56582
USA79168	G51703
USA79177	G52194
USA79178	G52193
USA79179	G51704
USA79186	G52007
USA79187	G52004

CONDUMEX	GRC
USA79195	G56886
USA79196	G56887
USA79198	G52211
USA79219	G52082
USA79220	G52081
USA79221	G51842
USA79222	G52122
USA79223	G52121
USA79225	G56889
USA79226	G56888
USA79227	G52104
USA79228	G52103
USA79229	G51723
USA79230	G51724
USA79231	G56838
USA79232	G56839
USA79233	G56807
USA79234	G56817
USA79242	G52345
USA79243	G52344
USA79247	G52340
USA79248	G52339

CONDUMEX	GRC
USA79262	G52262
USA79263	G52263
USA79264	G51908
USA79267	G52312
USA79268	G52313
USA79230	G51724
USA79231	G56838
USA79232	G56839
USA79233	G56807
USA79234	G56817
USA79242	G52345
USA79243	G52344
USA79245	G52006
USA79246	G52005
USA79247	G52340
USA79248	G52339
USA79262	G52262
USA79263	G52263
USA79264	G51908
USA79267	G52312
USA79268	G52313
USA79274	G52217

INTERCAMBIO KYB VS GRC

KYB	GRC
231002	G55705
231013	G44451
231013	G56705
231014	G44451
231014	G56706
231015	G55579
232003	G55713
232004	G55713
232011	G55544
232012	G55544
232021	G55615
232022	G55615
232025	G55891
232026	G55891
232027	G55772
232028	G55752
232029	G55752
232033	G55776
232034	G55776
233021	G44773

KYB	GRC
233021	G55516
233022	G55737
233023	G55738
233025	G55561
234001	G55507
234005	G55512
234008	G55602
234009	G55602
234011	G55725
234016	G55733
234019	G55514
234027	G55731
234031	G55557
234032	G55557
234037	G55847
234038	G55847
234039	G55848
234040	G55848
234041	G55780
234042	G55780

KYB	GRC
234043	G55586
234055	G55801
234056	G55800
234057	G55999
234058	G55999
234059	G55662
234060	G55661
234061	G55911
234062	G55911
234601	G55664
234602	G55663
234603	G55665
234901	G55680
234902	G55679
235002	G56503
235005	G56504
235008	G55510
235009	G55551
235012	G55542
235013	G55542

KYB	GRC
235019	G55521
235020	G55521
235021	G55527
235025	G56707
235028	G55529
235029	G55529
235029	G55580
235032	G55609
235032	G55945
235033	G55592
235034	G55584
235039	G55653
235040	G55652
235041	G55590
235042	G55589
235043	G55589
235046	G55600
235047	G55600
235048	G55601
235054	G55616

INTERCAMBIO KYB VS GRC

KYB	GRC
235058	G55921
235059	G55920
235060	G55681
235061	G56513
235062	G56512
235063	G55923
235064	G55924
235067	G55927
235068	G55928
235071	G55931
235072	G55932
235073	G55933
235074	G55934
235601	G55670
235602	G55671
235603	G55672
235604	G56719
235604	G56724
235605	G56720
235605	G56723
235607	G55666
235607	G55833
235608	G55667
235608	G55832
235614	G55989
235617	G55664
235618	G55663
235619	G55856
235620	G56520
235621	G55693
235624	G55994
235625	G55993
235626	G55896
235627	G55892
235628	G55893
235629	G55894
235630	G56635
235631	G56636
235701	G56795
235702	G56796
235703	G52014
235704	G52013
235901	G55525
235902	G55526
235903	G55685
235910	G55692

KYB	GRC
235911	G55693
235912	G56568
235913	G56601
235914	G56515
235915	G56515
235916	G56801
235917	G56801
235920	G56817
235921	G56655
235950	G55892
235951	G55892
235951	G55893
235952	G55526
236001	G56700
236002	G56701
236003	G56708
236005	G56714
236007	G56718
236010	G56715
321246	G56566
331003	G55904
331005	G55903
331008	G56622
331009	G56621
331010	G56678
331011	G56677
331016	G51718
331017	G51728
331021	G56622
331022	G56621
331027	G56678
331028	G56677
331035	G56799
331036	G56800
331037	G56799
331038	G56800
331039	G52113
331040	G52112
331043	G51718
331048	G56799
331049	G56800
331050	G56799
331051	G56800
331449	G51985
331449	G51987
331450	G51984

KYB	GRC
331450	G51986
331613	G52349
331614	G52348
331701	G52343
331702	G52341
332026	G55746
332027	G55746
332028	G55745
332029	G55745
332056	G55976
332057	G55977
332080	G55850
332081	G55850
332094	G55890
332095	G55890
332108	G56898
332109	G56897
332112	G56529
332113	G56530
332130	G52052
332131	G52053
332144	G52340
332145	G52339
332152	G52454
332153	G52453
332504	G52224
332505	G52223
333051	G55557
333052	G55557
333067	G55828
333068	G55828
333089	G55658
333090	G55657
333109	G56569
333110	G56570
333111	G56571
333111	G56637
333114	G55999
333115	G55999
333116	G55661
333118	G55591
333119	G55591
333141	G55714
333157	G35098
333182	G55881
333183	G55882

KYB	GRC
333184	G55883
333185	G55884
333205	G56525
333205	G56540
333206	G56526
333206	G56539
333207	G52336
333207	G56527
333208	G52335
333208	G56528
333209	G55879
333210	G55879
333211	G55849
333212	G55849
333215	G56628
333216	G56629
333219	G55970
333220	G55971
333224	G56529
333225	G56530
333236	G55999
333237	G55999
333254	G56767
333255	G56768
333258	G56572
333262	G56531
333263	G56532
333264	G56533
333265	G56534
333274	G56535
333274	G56633
333275	G56536
333275	G56634
333276	G56537
333277	G56538
333298	56980
333299	56980
333304	G56896
333305	G56895
333310	G56740
333310	G56805
333311	G56741
333311	G56806
333312	G56626
333313	G56627
333314	G52064

INTERCAMBIO KYB VS GRC

KYB	GRC
333315	G52063
333316	G56893
333317	G56892
333320	G52625
333321	G52624
333331	G52283
333332	G52282
333340	G55991
333340	G56999
333344	G56618
333345	G56619
333348	G56517
333349	G56516
333350	G56633
333351	G56634
333354	G52020
333355	G52019
333356	G52022
333357	G52021
333360	G52078
333361	G52077
333364	G52018
333365	G52017
333368	G52590
333382	G56894
333385	G52098
333388	G56891
333389	G56890
333390	G52194
333391	G52193
333394	G52056
333395	G52055
333416	G55514
333417	G56886
333418	G56887
333419	G56885
333420	G56884
333425	G56887
333426	G56886
333431	G52076
333432	G52075
333453	G52345
333454	G52344
333457	G52215
333458	G52214
333461	G56809

KYB	GRC
333462	G56809
333474	G52283
333475	G52282
333490	G52161
333491	G52160
333492	G52163
333493	G52162
333494	G52255
333495	G52256
333497	G52334
333498	G52333
333500	G56641
333501	G56640
333502	G56781
333503	G56782
333508	G56643
333509	G56642
333510	G56645
333511	G56644
333512	G52016
333513	G52015
333516	G52155
333517	G52154
333602	G52095
333603	G52094
333617	G52440
333618	G52439
333700	G56748
333701	G56742
333702	G56742
333702	G56749
333708	G56648
333718	G52011
333721	G52221
333722	G52222
333729	G52047
333730	G52046
333741	G52211
333755	G56978
333755	G52226
333756	G56979
333756	G52225
333765	G52040
333766	G52492
333767	G52491
333781	G56641

KYB	GRC
333782	G56640
333827	G56694
333919	G56605
333920	G56604
334015	G56518
334016	G56518
334030	G55587
334030	G55605
334050	G55606
334051	G55606
334093	G55653
334094	G55652
334109	G55929
334109	G56541
334110	G55930
334110	G56542
334111	G55857
334111	G55925
334112	G55858
334112	G55926
334115	G55859
334116	G55860
334125	G56574
334126	G56575
334131	G55914
334132	G55914
334133	G55676
334134	G55675
334135	G55668
334136	G55669
334141	G56577
334150	G55912
334151	G55913
334158	G55607
334159	G55608
334164	G56579
334165	G56580
334168	G55978
334169	G55901
334170	G56502
334171	G56502
334188	G55697
334189	G56543
334190	G56544
334191	G56545
334192	G56546

KYB	GRC
334195	G56518
334196	G56518
334209	G56765
334210	G56766
334227	G55948
334228	G52244
334228	G55949
334229	G55974
334230	G55975
334241	G56632
334242	G56631
334245	G56514
334246	G56506
334251	G56632
334252	G56631
334261	G56547
334262	G56548
334263	G56553
334263	G56682
334264	G56554
334264	G56681
334265	G56684
334266	G56683
334267	G56551
334268	G56552
334271	G52228
334272	G52227
334275	G56814
334276	G56813
334277	G56585
334278	G56586
334282	G56588
334283	G56589
334292	G55960
334293	G55960
334294	G55901
334295	G56501
334300	G52072
334301	G52071
334304	G56803
334305	G56804
334306	G52074
334307	G52073
334316	G55698
334317	G56558
334318	G56559

INTERCAMBIO KYB VS GRC

KYB	GRC
334321	G56784
334322	G56785
334325	G55518
334333	G56568
334334	G56601
334335	G56620
334336	G56672
334337	G56671
334338	G56674
334339	G56673
334340	G56676
334341	G56675
334342	G52070
334343	G52069
334344	G52179
334345	G52178
334356	G52086
334357	G52085
334358	G52090
334359	G52089
334360	G52001
334361	G52000
334362	G52003
334363	G52002
334364	G56758
334365	G56759
334366	G56686
334367	G56685
334368	G52065
334370	G52068
334371	G52067
334378	G56576
334379	G56573
334380	G52008
334381	G52009
334384	G56735
334385	G56734
334386	G56722
334387	G56721
334388	G56729
334389	G56728
334394	G56733
334395	G56732
334399	G56680
334399	G56731
334400	G56679

KYB	GRC
334400	G56730
334401	G56690
334402	G56689
334418	G56624
334419	G56625
334420	G56894
334428	G56668
334429	G56667
334430	G56797
334431	G56798
334432	G52169
334433	G52168
334440	G56671
334441	G56672
334449	G56691
334450	G56660
334451	G56661
334454	G52032
334455	G52033
334460	G52088
334461	G52087
334464	G52185
334465	G52184
334466	G55666
334467	G55667
334468	G52181
334469	G52180
334472	G56842
334473	G56843
334476	G55914
334477	G55914
334480	G55912
334481	G55913
334482	G56632
334483	G56631
334486	G55921
334487	G55920
334500	G56561
334501	G56562
334502	G56820
334503	G56819
334504	G56821
334505	G56822
334506	G52159
334507	G52158
334508	G52248

KYB	GRC
334509	G52247
334604	G56760
334605	G56761
334611	G56802
334614	G52236
334614	G56751
334614	G56757
334615	G52235
334615	G56750
334615	G56756
334621	G52165
334621	G52298
334622	G52164
334622	G52297
334623	G52639
334624	G52638
334632	G52044
334633	G52045
334636	G52111
334637	G52110
334638	G52137
334639	G52136
334640	G52139
334641	G52138
334642	G52082
334643	G52081
334644	G56841
334645	G56840
334652	G52130
334653	G52129
334658	G52082
334659	G52081
334673	G52504
334674	G56608
334675	G56608
334676	G56611
334677	G55878
334678	G56612
334679	G52066
334680	G52124
334680	G56815
334681	G52123
334681	G56816
334684	G52281
334685	G52280
334686	G52396

KYB	GRC
334687	G52395
334688	G52176
334689	G52175
334692	G52352
334693	G52351
334700	G52006
334701	G52005
334812	G56606
334834	G52311
334835	G35066
334835	G52048
334835	G52218
334840	G56837
334841	G56836
334842	G52079
334842	G52275
334843	G52080
334843	G52274
334846	G56649
334847	G56650
334903	G56769
334945	G56755
334946	G56754
334981	G52503
334982	G52502
334983	G51964
334983	G52474
334984	G51963
334984	G52473
335009	G56714
335010	G56714
335014	G55831
335015	G56736
335016	G56739
335020	G55867
335021	G55868
335022	G56736
335023	G56739
335030	G56616
335031	G56615
335032	G56688
335033	G56687
335035	G56688
335036	G56687
335037	G56509
335040	G56581

INTERCAMBIO KYB VS GRC

KYB	GRC
335041	G56582
335044	G55834
335045	G56508
335052	G52363
335053	G52362
335054	G52271
335055	G52270
335057	G52167
335058	G52166
335059	G52645
335060	G52644
335061	G52025
335063	G52035
335064	G52034
335065	G52116
335072	G52128
335073	G52127
335074	G52499
335075	G52498
335082	G52294
335083	G52293
335610	G52399
335611	G52398
335619	G52444
335619	G52514
335620	G52443
335620	G52513
335623	G52406
335624	G52512
335625	G52511
335803	G52216
335808	G56899
335814	G52301
335816	G52314
335819	G52220
335906	G56770
335907	G56771
335920	G56791
335920	G56792
335924	G52145
335925	G52144
335926	G52637
335927	G52636
338007	G52338
338008	G52337
338009	G52153

KYB	GRC
338010	G52152
338011	G56887
338012	G56886
338013	G56837
338014	G56836
338022	G52157
338023	G52156
338026	G52472
338027	G52471
338087	G52450
338088	G52449
338739	G56982
338740	G56983
339015	G55948
339017	G55668
339018	G55669
339019	G55668
339020	G55669
339023	G56888
339024	G56889
339025	G52104
339026	G52103
339029	G56883
339030	G56882
339031	G52007
339032	G52004
339035	G52039
339036	G52038
339037	G52250
339038	G52249
339039	G52151
339040	G52150
339041	G52167
339042	G52166
339043	G52104
339044	G52103
339051	G52029
339052	G52028
339053	G52026
339054	G52027
339055	G52062
339056	G52061
339057	G56773
339058	G56774
339072	G52141
339073	G52140

KYB	GRC
339082	G52408
339083	G52407
339084	G56810
339085	G56810
339086	G56514
339087	G56506
339088	G56772
339089	G56812
339096	G52024
339097	G52023
339098	G52273
339099	G52272
339100	G52108
339101	G52107
339102	G52106
339102	G52108
339103	G52105
339103	G52107
339104	G52263
339105	G52262
339114	G52246
339115	G52245
339121	G52084
339122	G52083
339124	G52300
339125	G52299
339128	G52097
339129	G52096
339136	G52377
339137	G52376
339140	G52261
339141	G52260
339146	G52122
339147	G52121
339149	G52183
339150	G52182
339151	G55866
339152	G55865
339155	G52210
339156	G52209
339171	G52595
339172	G52594
339183	G52643
339184	G52642
339188	G52171
339189	G52170

KYB	GRC
339190	G52122
339191	G52121
339196	G52174
339197	G52173
339204	G52265
339205	G52264
339214	G52662
339215	G52661
339216	G52204
339217	G52203
339220	G52031
339221	G52030
339222	G52606
339223	G52605
339230	G52202
339231	G52201
339234	G52204
339235	G52203
339242	G52332
339243	G52331
339246	G52131
339247	G52118
339248	G52117
339249	G52149
339250	G52148
339261	G52188
339262	G52187
339263	G52253
339264	G52254
339265	G52621
339266	G52620
339269	G52143
339270	G52142
339272	G52125
339277	G52417
339277	G52697
339278	G52416
339278	G52696
339281	G52448
339282	G52447
339288	G52425
339289	G52426
339290	G52486
339291	G52485
339292	G52458
339292	G52660

INTERCAMBIO KYB VS GRC

KYB	GRC
339293	G52457
339293	G52659
339294	G52466
339295	G52465
339309	G52258
339310	G52257
339334	G52658
339335	G52657
339336	G52654
339337	G52653
339347	G52525
339348	G52524
339349	G52452
339350	G52451
339361	G52361
339362	G52360
339363	G52464
339364	G52463
339365	G52484
339366	G52483
339367	G52529
339368	G52528
339373	G52432
339374	G52433
339375	G52436
339376	G52435
339377	G52279
339377	G52601
339378	G52278
339378	G52600
339383	G52375
339384	G52374
339387	G52595
339388	G52594
339389	G52415
339390	G52414
339416	G52392
339417	G52391
339418	G52470
339419	G52469
339422	G52493
339702	G56649
339703	G56650
339711	G52217
339718	G52676
339719	G52675

KYB	GRC
339741	G52585
339758	G56692
339759	G56693
340002	G55723
340008	G55766
340009	G51039
340010	G511020
340011	G511019
340012	G51876
340013	G51875
340019	G51815
340020	G511023
340021	G511022
340022	G51806
340026	G511075
340027	G51910
340028	G51856
340033	G52409
340034	G511063
340038	G51897
340039	G51896
340040	G51878
340041	G51877
340044	G51892
340047	G52641
340048	G52640
340049	G51919
340050	G51937
340054	G51918
340055	G51917
340056	G51911
340069	G51975
340073	G51864
340090	G51933
340096	G52596
340099	G511014
340100	G511013
340115	G51972
341007	G51006
341012	G51229
341050	G51034
341050	G51170
341054	G51424
341063	G51173
341065	G51181
341069	G51197

KYB	GRC
341070	G51193
341072	G55742
341073	G55742
341074	G55743
341081	G51346
341084	G51249
341094	G55803
341099	G51191
341111	G51060
341112	G55730
341112	G55770
341113	G55730
341113	G55770
341114	G51184
341116	G55769
341117	G55774
341118	G55774
341119	G55786
341120	G56591
341121	G51046
341124	G51033
341125	G55804
341126	G51195
341127	G51196
341133	G51165
341135	G55773
341136	G55773
341137	G55788
341138	G55802
341139	G55802
341140	G51063
341141	G55820
341142	G51253
341149	G51189
341150	G51188
341151	G51190
341159	G56592
341161	G51709
341162	G51710
341163	G55819
341164	G51712
341165	G51254
341174	G55877
341175	G55877
341176	G55786
341177	G51264

KYB	GRC
341177	G55795
341178	G51264
341178	G55795
341179	G55805
341190	G51227
341191	G51252
341192	G51290
341194	G51230
341196	G56594
341197	G56595
341198	G55910
341200	G55877
341201	G55877
341202	G51087
341203	G55909
341205	G51742
341207	G51101
341211	G51744
341216	G51183
341237	70009
341244	G55825
341245	G56565
341249	40025
341249	42956
341250	70072
341251	G51839
341253	G56596
341254	G56597
341257	G55870
341258	G55871
341259	G51826
341260	G51255
341261	G51256
341262	G51834
341263	G51835
341266	G56598
341267	G56599
341268	G56593
341269	G56600
341271	G51727
341273	G51743
341274	G51772
341276	G51767
341277	G56587
341279	G51279
341280	G51714

INTERCAMBIO KYB VS GRC

KYB	GRC	KYB	GRC	KYB	GRC	KYB	GRC
341280	G51899	341404	G51882	341495	G51847	341952	G56712
341281	G51713	341405	G51859	341496	G51735	341953	G51733
341282	G51730	341406	G51859	341499	G51848	343010	69787
341293	G51254	341412	69579	341600	G51715	343023	69670
341299	G51740	341419	G51723	341601	G51703	343024	69671
341302	G63678	341425	G51977	341602	G51703	343030	61550
341304	69579	341428	G51814	341603	G56807	343030	G63949
341311	G51700	341429	G51813	341605	G51719	343039	69713
341312	G64087	341432	G52058	341606	G51720	343056	69733
341321	G51840	341433	G52057	341607	G51729	343127	42446
341322	G51795	341437	G51829	341608	G51760	343127	42494
341326	G51722	341439	G51294	341609	G51761	343127	69600
341327	G51724	341439	G51895	341650	G55818	343127	82118
341330	G51737	341440	G51477	341651	G51078	343127	G63900
341331	G51738	341441	G51926	341654	G51842	343128	82110
341339	G63918	341442	G51925	341655	G51770	343128	G63375
341340	G51739	341444	G51908	341656	G51771	343129	82129
341341	G51727	341445	G511065	341658	70027	343130	82051
341342	G51794	341448	G51898	341659	70027	343131	69624
341343	G63783	341457	G51852	341661	G51704	343132	81438
341343	G63893	341458	G51854	341662	G51703	343135	69606
341344	G51739	341459	G51853	341663	G51720	343135	82074
341348	G51838	341462	G51857	341664	G51719	343138	69704
341351	G51811	341463	G51286	341665	G51729	343139	69703
341352	G51810	341467	G51766	341668	G51842	343140	69674
341353	G51886	341468	G51765	341670	70032	343141	82614
341353	G56557	341470	G51890	341671	G51860	343142	82608
341356	G51204	341471	G51889	341672	G51861	343143	82005
341361	G51838	341472	G51849	341674	G51865	343144	82001
341362	G51716	341474	G56838	341678	G51216	343149	81340
341364	G52037	341475	G56839	341679	G51836	343149	82155
341365	G52036	341476	G51806	341680	G51837	343157	69724
341368	G51794	341479	G51863	341704	G51900	343160	69723
341369	G51738	341480	G51855	341706	G511011	343160	G63914
341372	G52212	341481	G51774	341707	G511010	343161	69755
341373	G51883	341482	G52378	341710	G511012	343162	69709
341374	G51850	341483	G51825	341717	G52626	343163	69633
341374	G63884	341484	G51815	341720	G52627	343164	69632
341376	G51830	341485	G51758	341814	69586	343177	42530
341382	G51736	341486	G51961	341823	G51915	343177	69749
341392	G51832	341487	G52596	341842	G51097	343191	G51022
341393	G51833	341488	G51286	341842	G51099	343208	G63902
341394	G56786	341492	G51879	341845	G51740	343208	G63909
341395	G56787	341493	G51870	341907	G51759	343208	42972
341402	G51880	341493	G51891	341924	G51881	343209	G63903
341403	G51909	341493	G57000	341952	G51295	343211	69676

INTERCAMBIO KYB VS GRC

KYB	GRC
343218	69622
343218	81880
343240	G63907
343247	G63799
343252	G63907
343255	69863
343262	69462
343270	70020
343271	G51100
343272	G63860
343280	69945
343281	69946
343290	69464
343290	81935
343291	69465
343295	69450
343304	70019
343307	69573
343308	69573
343313	G63860
343314	G63860
343319	69924
343324	G63495
343328	70007
343342	G63902
343346	G64057
343348	69945
343348	81934
343352	69863
343353	70001
343353	G63880
343367	G63907
343379	G63845
343381	70060
343385	69473
343388	G63712
343395	G63842
343395	G64014
343402	69407
343403	G63660
343410	G63937
343412	70003
343413	69464
343419	70056
343419	G51841
343423	G51747

KYB	GRC
343425	70160
343425	G63409
343426	70028
343429	69464
343432	42954
343435	G64052
343439	69726
343442	G51783
343444	G63907
343452	69420
343453	69416
343454	69589
343455	69584
343458	70041
343459	G511083
343460	G51807
343462	G51706
343470	G51800
343470	G51946
343472	70074
343478	70015
343479	G51716
343487	70060
343488	70103
343493	G51999
343499	69583
343807	70014
344015	G63928
344040	70171
344040	G63421
344041	70173
344041	G63422
344042	61531
344042	81516
344042	G63423
344043	G63813
344043	G63909
344043	81478
344044	G63492
344044	G63907
344045	G63492
344046	70162
344046	G63491
344047	G63950
344049	G63414
344049	G63905

KYB	GRC
344050	G63427
344050	G63773
344051	G63420
344054	G63404
344054	G63444
344055	G63299
344055	G63484
344066	61523
344066	70166
344066	81096
344066	G63359
344067	G63347
344068	G63355
344069	G63500
344070	G63353
344071	G63350
344072	G63349
344073	G63413
344074	G63811
344075	G63413
344075	G63906
344076	G63410
344076	G63414
344077	58409
344077	G63409
344077	G63809
344078	70160
344078	G63683
344079	61530
344079	81510
344079	G63456
344079	G63461
344080	G63426
344080	G63690
344081	G63375
344082	G63454
344083	G63457
344084	G63490
344085	G63306
344086	70167
344086	G63353
344088	G63424
344089	G63425
344089	G63683
344090	G63492
344090	G63928

KYB	GRC
344091	G63511
344092	G63490
344093	G63881
344093	G63905
344094	G63915
344095	G63499
344096	G63460
344097	81147
344098	61545
344098	G63612
344110	69845
344202	G63479
344204	G64059
344222	G63782
344223	G63781
344229	G63708
344262	G63638
344263	G63488
344263	G63638
344264	G63387
344265	G63489
344265	G63783
344266	G63609
344266	G63818
344267	58717
344267	G63455
344267	G63717
344268	G63614
344268	81744
344269	G63607
344270	69805
344271	69756
344272	G63386
344273	G63638
344274	G55821
344290	G63490
344291	G63676
344291	G63873
344294	G64027
344295	G64028
344296	70000
344298	G63611
344299	G63710
344300	G64036
344308	G51805
344314	G51705

INTERCAMBIO KYB VS GRC

KYB	GRC
344338	G63776
344341	G63847
344342	G63829
344353	69909
344353	G63877
344356	G63862
344359	G63720
344363	69591
344364	G63673
344364	G63674
344365	G63662
344366	G63366
344367	G63714
344368	58716
344368	G63716
344369	G63624
344370	G63622
344371	G63623
344372	81928
344372	G63661
344373	G63675
344374	G63778
344374	G63870
344375	G63715
344375	G63867
344375	81913
344376	81919
344376	G63673
344377	G63717
344378	G63403
344379	G63403
344380	G63783
344381	81922
344381	G63803
344382	G63808
344382	G63887
344383	G63817
344384	G63866
344385	58412
344385	81931
344385	G63866
344387	58617
344387	G63617
344388	G63929
344395	G51725
344396	G63525

KYB	GRC
344397	G63772
344398	G63958
344399	81932
344399	G63848
344400	G63958
344401	G63970
344402	G63783
344403	81929
344403	G63722
344404	G63844
344407	70012
344409	G63918
344410	G63885
344414	G63870
344415	G63867
344418	G63377
344419	G63888
344419	G64010
344424	69675
344426	G63299
344427	G63904
344427	G63909
344428	G63494
344429	G63907
344430	G63611
344430	G63909
344431	G63620
344432	69962
344433	69898
344435	81936
344435	G63721
344437	G63866
344438	G63869
344439	G51798
344440	G64105
344447	G63689
344448	G63689
344450	G51802
344456	G64090
344459	G51799
344463	69580
344463	70159
344464	G63882
344465	G63884
344466	G63879
344468	G63907

KYB	GRC
344469	61662
344469	G63813
344475	G63902
344479	G51803
344480	G51804
344481	G63894
344483	G63896
344487	70034
344491	G51812
344493	G64058
344493	G51894
344496	G64012
344500	G64048
344501	70049
344606	G55951
344607	G55958
344608	G55952
344609	G51267
344609	G51796
344610	G51268
344611	G51858
344612	G51736
344613	G51768
344655	70068
344656	G64124
344656	G64144
344663	G64143
344707	69579
344800	70006
344803	G64061
344806	G51968
345005	G63694
345006	69861
345014	G63506
345022	G63832
345023	G63828
345024	G63864
345030	G63394
345042	G63883
345043	G63878
345055	G63872
345055	G64015
345056	G64033
345059	G64064
345063	42577
345066	G63875

KYB	GRC
345067	G64031
345068	69594
345073	G64101
345074	G63959
345075	69595
345084	G63872
345088	70087
345609	G63616
345624	G52430
345624	G64148
345625	G511000
345627	G51928
348002	70036
348004	G51801
348014	70011
348015	G64062
348018	70052
348021	G51905
348029	G51990
348032	G511009
348032	G51971
348036	70063
348062	70073
348066	G511092
348067	G511082
348074	G51976
349004	G63886
349004	G63963
349004	58944
349005	G64032
349007	70039
349008	69590
349009	G63897
349009	G63919
349010	G63889
349010	G64006
349011	G64004
349011	G64005
349022	70061
349024	G64026
349025	G64080
349026	69592
349027	G51831
349031	61674
349031	G64083
349035	70053

INTERCAMBIO KYB VS GRC

KYB	GRC
349039	61704
349039	G64003
349040	G511004
349041	70045
349043	69587
349044	G64089
349045	G64091
349046	G63895
349047	G51764
349047	G51955
349052	70004
349053	G51927
349054	G63815
349054	G64038
349055	G64049
349057	G511066
349060	70013
349063	70100
349065	G51721
349067	G51993
349068	G64037
349069	G63967
349070	G64072
349071	G64008
349072	69573
349073	G64042
349075	G51874
349076	G64056
349080	G64063
349085	70037
349089	G511021
349090	G511064
349092	G51884
349093	G51874
349094	G64071
349095	G51966
349096	G511024
349097	G64050
349101	G64047
349105	70010
349108	G64079
349110	G64043
349115	70078
349117	G64042
349123	G64009
349124	G63966

KYB	GRC
349125	G63776
349130	G64040
349133	G511072
349134	G511076
349135	G64077
349136	70059
349139	70089
349141	G511069
349142	G51957
349147	G64121
349147	58943
349151	G64104
349165	70096
349166	G64130
349168	G64113
349194	G511002
349195	G51912
349195	G51913
349198	G51989
349203	G64126
349204	G511015
349207	69907
349216	G511042
349217	G64124
349217	G64144
349237	G511043
349240	G511044
349242	G64133
349242	G64154
361001	G44868
361002	G44869
361003	G44867
361005	44763
361005	G44763
361008	G44776
363010	G44735
363010	G44806
363012	G44862
363014	G44850
363016	G44713
363030	G44748
363037	G44800
363039	G44747
363039	G55715
363045	G44802
363046	G44803

KYB	GRC
363047	G44743
363063	G44723
364003	G44752
364014	G44774
364021	G44775
364024	44902
364024	G44902
365005	G44938
365006	G44856
365008	G44902
365016	G44477
365016	G44898
365025	G44903
365031	G44934
365037	G44940
365043	G44920
365053	G44941
365056	G44936
365056	G44968
365058	G44939
365060	G44937
365061	G44943
365061	G44982
365064	G44998
365070	G44986
365075	G44995
365079	G44990
365083	G44493
365085	G44999
365100	G44997
366002	G44450
366004	G44459
366005	G44920
366005	G44969
366007	G44497
366007	G44969
366007	G56607
366012	G244002
441110	40025
441120	G55698
442035	42508
443078	70161
443078	42972
443219	51022
443301	70019
443367	42161

KYB	GRC
443375	42094
443375	42953
443400	42954
443403	42520
443467	G64085
444236	70165
444249	G63489
444250	G63488
444256	42952
444322	G64084
444323	70163
444323	42973
551092	75898
551105	G511040
551106	G52647
551107	G52646
551108	G52648
551117	G51906
551118	G51907
551119	G51869
551130	G51921
551131	G51920
551132	G51922
551136	G511029
551600	G51887
551602	G51888
551605	G51746
551609	G51769
551610	G51773
551918	70040
552600	69998
553058	77492
553087	77904
553153	77907
553177	69995
553178	69807
553257	77492
553289	77903
553306	70033
553306	70057
553356	70093
553360	G63937
553361	G63689
553378	70005
553381	70038
553389	G51983

INTERCAMBIO KYB VS GRC

KYB	GRC
553392	G511001
553603	70031
553606	70023
554044	77726
554069	77479
554075	77907
554091	77782
554092	77781
554095	G64129
554101	77907
554120	77660
554128	77726
554131	77494
554154	77638
554155	77424
554156	77915
554158	77403
554159	77915
554160	77414
554160	77905
554161	77375
554163	77609
554166	77714
554167	77778
554168	77461
554169	77847
554170	77525
554171	77409
554172	77355
554175	77359
554176	77413
554178	77608
554179	77421
554180	77422
554183	77424
554184	77909
554186	77716
554187	77715
554188	77803
554189	77953
554198	77953
554199	77950
554200	77829
554206	77638
554207	77661
554208	77661

KYB	GRC
554209	77662
554223	77662
554224	77489
554228	77673
554229	77717
554230	77717
554233	77783
554234	77803
554235	77772
554236	77607
554236	77614
554238	77809
554239	77837
554241	77810
554242	77815
554243	77815
554247	77817
554248	77953
554249	77412
554253	77410
554254	77406
554255	77909
554256	77492
554257	77907
554259	77423
554261	77410
554262	77454
554266	77958
554268	77909
554274	77614
554275	77406
554293	G63841
554312	77375
554321	77954
554322	77949
554324	77638
554331	77909
554340	77902
554347	77967
554347	G63886
554353	G64140
554354	G64128
554362	77968
554362	58945
554363	G63964
554373	G64135

KYB	GRC
554378	70104
554382	70105
554384	70098
554385	70095
554385	70102
554387	G64125
554389	G64122
554389	G64149
554393	G64084
554394	G64085
554402	G511002
555038	77614
555039	77623
555049	G64001
555050	G63965
555054	77975
555055	77976
555058	77953
555601	69575
555603	69574
555603	77955
555604	G51904
555609	G51871
555610	G64046
555700	70002
564002	G51077
565007	77455
565016	77675
565018	77674
565036	77349
565037	77377
565037	77405
565040	G63890
565054	77425
565059	G63548
565061	77488
565063	77456
565063	77524
565069	G63411
565097	77979
565101	77783
632012	55713
632013	55713
632040	55745
632041	55745
632046	55746

KYB	GRC
632047	55746
632072	55976
632073	55977
633115	55658
633116	55657
633125	G55847
633126	G55847
633151	56630
633219	56980
633220	56980
633227	55991
633242	G55848
633243	G55848
633264	G55505
634821	G56982
634822	G56983
664024	44902
3440012	G511044
KG4159	G63892
KG4160	G64016
KG4162	77971
KG4192	69689
KG4503	82026
KG4503	82069
KG4507	82011
KG4515	82110
KG4522	69661
KG4529	69616
KG4530	69996
KG4531	69706
KG4531	81445
KG4537	69714
KG4538	69727
KG4539	69725
KG4540	69677
KG4544	69760
KG4549	69773
KG4613A	G63909
KG4616	G63798
KG4728	69878
KG4729	69877
KG4730	G51711
KG4731	69950
KG4731	69956
KG4731	70064
KG4732	69957

INTERCAMBIO KYB VS GRC

KYB	GRC
KG4740	69951
KG4740	70065
KG4741	69891
KG4741	G44461
KG4741	G44495
KG4742	69952
KG4743	69966
KG4752	61606
KG4752	77937
KG4752	81908
KG4752	G63937
KG5194	G64000
KG5196	G64013
KG5198A	G63606
KG5401	G63299
KG5404	G63360
KG5406	G63386
KG5415	77349
KG5417	G63371
KG5420	G63366
KG5421	G63387
KG5422	G63183
KG5424	G63187
KG5426	G63396
KG5429	G63398
KG54300	G63615
KG54301	G63616
KG54302	G63782
KG54303	G63781
KG54304	G63707
KG54305	61598
KG54305	G63640
KG54307	G63812
KG54308	G63708
KG54309	77678
KG5431	G63511
KG54317	G63726

KYB	GRC
KG54321	G511089
KG54326	G51870
KG54329	G63607
KG54330	G63809
KG54331	G63837
KG54332	77808
KG54333	G63810
KG54335	G63815
KG54336	77815
KG5438	G63492
KG5440	G63350
KG5441	58409
KG5442	G63626
KG5444	G63904
KG5446	G63909
KG5447	G63491
KG5456	G63416
KG5462	G63494
KG5463	61513
KG5466	G63492
KG5474	G63479
KG5475	61507
KG5475	G63432
KG5476	G63611
KG5477	G63906
KG5478	G63489
KG5479	G63488
KG5480	G63609
KG5481	58411
KG5482	G63675
KG5484	61596
KG5484	G63635
KG5485	G63639
KG5487	G63525
KG5488	G63403
KG5489	G63614
KG5490	77679

KYB	GRC
KG5491	G63604
KG5494	G63620
KG5495	G63929
KG5496	G63624
KG5497	G63622
KG5498	G63623
KG5499	G63621
KG5507	82051
KG5533	69766
KG5534	G63610
KG5538	82608
KG5538	G63484
KG5555	G63914
KG5557	69858
KG5564	69715
KG5569	69794
KG5570	69811
KG5571	69795
KG5571	75795
KG5571	81791
KG5747	69901
KG5787A	69757
KG6198	G63616
KG6403	G63605
KG6406	G63183
KG6412	G63625
KG9004	G51007
KG9006	G51013
KG9024	G51477
KG9025	G51077
KG9026	G51477
KG9113	G51232
KG9122	G51161
KG9129	G51180
KG9132	G51031
KG9307	G51330
SM5086	143279

KYB	GRC
SM5091	143330
SM5091	143423
SM5137	143320
SM5162	143367
SM5211	143315
SM5214	143140
SM5216	143322
SM5402	143265
SM5403	143353
SM5442	143325
SM5443	143404
SM5447	143354
SM5471	143355
SM5484	143368
SM5511	143364
SM5512	143321
SM5530	143316
SM5531	143324
SM5536	143317
SM5567	143344
SM5569	143319
SM5602	143318
SM5608	143363
SM5618	143342
SR1003	G56903
SR2011	G511038
SR4027	G57064
SR4028	G57063
SR4052	G57039
SR4079	G57000
SR4083	G57094
SR4084	G57093
SR4091	G57142
SS10317	14071
SS10323	6846SE

INTERCAMBIO MONROE VS GRC

Monroe	GRC
1000	82156
1089	42094
1131	42957
1195	40025
1195	42956

Monroe	GRC
1196	69579
1198	69579
1198	69588
1401	61531
1401	81516

Monroe	GRC
1401	58423
1401	G63423
1401	77423
1402	42973
1402	70172

Monroe	GRC
1404	42968
1406	42967
1407	42966
1407	81082
1408	42972

INTERCAMBIO MONROE VS GRC

Monroe	GRC
1408	70161
1409	42970
1409	G63491
1409	81097
1409	61505
1412	42964
1412	70160
1412	70163
1414	70164
1415	42958
1415	70165
1416	42962
1418	42963
1418	70176
1419	42971
1419	70168
1420	70169
1422	42959
1422	70170
1538	42161
2066	42446
2132	42494
2132	42969
2198	42530
2545	42952
2592	42953
3095	42459
3108	42517
3116	42508
3147	42520
3147	69726
3155	42577
5505	G511082
5505	G511092
5507	70007
5508	70014
5600	G51802
5601	70028
5602	G51904
5603	G51871
5604	70004
5605	70060
5605	G51905
5606	70009
5607	70003
5608	G64060

Monroe	GRC
5609	G51807
5611	G51799
5614	70013
5615	70049
5616	70045
5617	70056
5618	70039
5621	70036
5622	70037
5624	G51783
5626	70041
5630	70052
5631	G511021
5631	G511024
5633	G51927
5637	G51874
5639	70027
5641	69726
5642	70061
5643	G51968
5645	G511002
5646	70068
5647	70059
5648	70096
5656	70100
5657	G64125
5658	G51976
5660	70011
5661	70015
5662	G51982
5663	G511009
5663	G51971
5667	G51965
5669	70006
5672	70095
5672	70102
5682	G511037
5683	G51983
5685	70053
5695	42954
5696	69573
5754	82138
5756	82070
5757	82060
5757	82610
5759	82087

Monroe	GRC
5761	82617
5762	82615
5765	82118
5766	82051
5767	81557
5768	69462
5769	82614
5770	82608
5772	82067
5777	69585
5777	G63880
5778	69590
5779	69587
5780	69589
5781	69924
5782	70005
5783	69592
5783	69593
5784	69591
5785	69584
5786	70032
5788	70031
5791	70007
5792	70002
5794	G51747
5795	G51764
5795	G51812
5796	69464
5797	G51721
5798	G64057
5799	70001
5801	69675
5802	69604
5802	69724
5803	81340
5809	82069
5811	82011
5817	81438
5818	82155
5819	82004
5821	81670
5821	82129
5827	G511036
5829	69704
5829	G55507
5831	69624

Monroe	GRC
5837	69703
5839	82603
5840	69600
5843	14020
5843	69706
5845	69755
5847	69633
5847	69755
5847	75755
5850	69622
5861	69709
5867	69676
5867	75676
5868	69787
5870	69713
5877	69689
5879	69881
5881	69674
5882	69880
5882	81498
5892	69714
5892	69811
5892	75811
5893	69715
5896	69749
5897	69723
5906	69625
5910	69616
5914	69733
5914	81450
5921	69727
5928	69757
5930	69805
5936	69756
5938	69794
5939	69795
5939	75795
5939	81791
5945	42508
5948	69808
5950	69820
5955	69724
5959	69632
5960	69675
5961	69606
5965	69845

INTERCAMBIO MONROE VS GRC

Monroe	GRC	Monroe	GRC	Monroe	GRC	Monroe	GRC
5967	69606	31000	82156	32127	58360	32215	81560
5968	69898	31000	G63443	32127	58389	32216	81491
5968	75898	31029	61549	32127	70166	32217	61545
5970	69407	31029	81675	32127	81096	32217	81553
5971	70098	31029	G63798	32127	81834	32217	81872
5974	69863	31069	81270	32128	81091	32217	G63612
5975	69901	31089	82001	32132	61529	32219	81691
5976	69670	31094	61506	32132	61540	32220	81583
5977	69671	31094	61532	32132	70171	32220	61541
5978	69417	31094	61666	32132	81494	32220	G63490
5980	69903	31094	81318	32132	81582	32221	61596
5981	69725	31094	81538	32132	81750	32222	61597
5981	69863	31094	81894	32134	81153	32222	81907
5982	69903	31094	82012	32150	81694	32223	81562
5983	69891	31125	61502	32151	81338	32224	81668
5984	69945	31125	82125	32153	81322	32225	81667
5986	69465	31131	70175	32164	81484	32226	81490
5987	69450	31131	81469	32165	82013	32226	58414
5988	81897	31131	81825	32186	70173	32226	61520
5989	69473	31131	82054	32186	81482	32226	G63414
5990	G51725	31162	61505	32191	82002	32226	77414
5991	70020	31162	61594	32194	61531	32227	81490
5992	G51885	31162	70162	32194	81516	32228	61554
5993	69575	31162	81097	32196	61615	32228	G63409
5996	69420	31163	81416	32196	81936	32228	77409
5997	69416	31163	81440	32197	81549	32228	81710
5998	69863	31176	81406	32198	81530	32230	81727
6717	G63616	31197	G51706	32198	81742	32231	81710
6801	G63484	31538	82005	32201	81671	32233	61538
6803	G63907	32022	82090	32202	69755	32233	81529
6817	G63355	32066	81446	32202	81674	32235	81744
6824	G63349	32066	81541	32203	81558	32235	40026
6831	G63359	32066	82099	32205	82093	32237	61533
6839	G63357	32067	82601	32206	61667	32237	61627
6868	G63360	32073	82131	32206	81507	32237	81539
6900	G63386	32075	81394	32206	81884	32237	81730
6910	G63413	32075	82033	32207	61550	32237	81917
6911	G63350	32080	81242	32207	69884	32237	40027
6920	G63411	32103	82130	32207	81676	32238	61534
6927	G63409	32112	81095	32207	82007	32238	61573
6945	G63421	32113	61501	32207	G63441	32238	61629
6960	G63366	32113	81478	32211	81583	32238	81540
31000	81147	32118	82128	32212	61539	32238	81905
31000	81542	32126	82039	32212	81581	32238	81918
31000	82006	32126	82074	32214	81559	32243	81490
31000	82030	32126	82123	32215	61511	32243	61520

INTERCAMBIO MONROE VS GRC

Monroe	GRC
32243	77414
32243	61520
32243	81490
32245	61552
32245	81870
32247	61510
32247	81871
32248	61588
32248	81906
32249	77904
32250	61601
32250	61679
32250	81836
32250	81902
32251	61584
32251	81837
32252	81548
32253	61624
32253	81890
32254	81726
32255	61569
32255	81826
32258	61556
32258	81714
32259	81744
32260	81833
32262	81270
32263	81726
32264	81789
32264	61565
32264	G63896
32264	77638
32264	58638
32265	81789
32267	81744
32268	81828
32269	61575
32269	81891
32270	61582
32271	61607
32271	81872
32272	61608
32272	81909
32273	77782
32273	G63782
32274	77781

Monroe	GRC
32274	G63781
32275	61625
32275	81882
32277	81928
32278	81873
32279	81919
32280	81490
32280	58414
32280	61520
32280	G63414
32280	77414
32281	82147
32284	81285
32288	81821
32290	61605
32290	81878
32292	61606
32292	81908
32293	G63689
32293	61500
32294	61700
32295	61699
32296	81893
32297	61503
32298	81790
32299	81927
32300	61504
32300	81750
32301	82003
32302	81912
32303	81892
32304	81914
32305	81913
32305	58715
32305	61612
32305	G63715
32305	77715
32306	61616
32306	81929
32314	61568
32314	81318
32314	G63604
32315	G63720
32316	61560
32316	81904
32317	69675

Monroe	GRC
32317	81713
32318	81559
32319	61658
32319	81923
32319	G63403
32321	61658
32321	81923
32322	61614
32322	G63717
32322	77717
32322	58717
32323	61614
32323	G63717
32323	77717
32323	58717
32324	81892
32326	81920
32327	81873
32328	G63803
32328	61643
32328	81922
32328	58803
32329	81921
32330	61626
32330	81916
32332	61614
32332	G63717
32332	77717
32332	58717
32333	61659
32333	81924
32334	G63726
32335	81910
32336	61593
32336	81872
32337	61610
32337	81911
32338	61664
32338	81869
32339	61676
32339	81926
32340	81920
32341	81921
32344	81930
32345	81921
32345	77412

Monroe	GRC
32345	G63675
32345	61642
32346	61623
32346	81893
32347	77803
32347	G63803
32347	61643
32347	58803
32347	81922
32348	77953
32348	G63866
32348	61675
32348	58930
32348	81930
32350	81925
32355	14039
32356	G63622
32356	G63614
32356	77614
32357	61654
32358	61655
32358	G63809
32358	58809
32358	77809
32359	61656
32359	58810
32359	G63810
32359	77810
32360	81082
32361	G63394
32362	81668
32363	G63812
32365	81921
32366	58674
32366	61635
32366	G63674
32366	77674
32370	G63692
32371	81096
32372	81507
32373	81726
32375	81342
32376	58360
32376	61650
32376	81834
32376	G63360

INTERCAMBIO MONROE VS GRC

Monroe	GRC
32381	61546
32383	61509
32383	81541
32384	61649
32384	81174
32385	42960
32385	70167
32385	81091
32385	61526
32385	G63353
32386	81510
32388	G64027
32389	G64028
32390	81933
32391	81931
32392	81932
32393	G63607
32394	G63809
32395	G63837
32400	77949
32401	81931
32402	61712
32403	81934
32404	81935
32405	61720
32405	G64016
32406	G63892
32407	61715
32407	G64012
32410	G51725
32545	82032
32592	82031
33033	42961
33033	81039
33033	61525
33033	G63355
33049	61558
33049	61586
33049	61592
33049	81340
33049	81495
33049	81937
33049	82034
33049	82066
33049	82124
33049	82155

Monroe	GRC
33050	82602
33053	82069
33053	82126
33059	81076
33059	82104
33074	58347
33074	81113
33076	58357
33076	81108
33082	81492
33082	81514
33084	81164
33086	81496
33086	58906
33086	61522
33086	G63906
33090	81464
33090	81739
33095	81459
33097	81460
33097	81674
33100	81445
33101	82010
33102	69727
33104	81792
33108	69723
33108	81517
33116	81508
33121	81880
33122	81481
33123	69675
33123	81446
33127	81446
33128	81495
33129	81693
33131	81793
33132	81461
33132	81881
33133	81555
33134	81795
33136	81495
33137	81794
33146	61674
33146	G64083
33147	69726
33149	69573

Monroe	GRC
33151	42954
33152	42955
33156	70012
33157	G51800
33157	G51946
33158	G51733
33158	G51801
33159	69583
33159	G64064
33160	G64062
33272	81501
33274	69909
34501	58803
34501	61643
34504	58817
34504	61663
34514	G63958
34515	61691
34515	61692
34516	G63848
34518	G63809
34519	G63837
34520	77949
34521	61709
34521	61710
34521	61716
34522	61714
34523	77967
34523	G63969
34524	77968
34524	77969
34524	G63963
34525	61680
34526	61681
34530	61685
34655	58714
34655	61611
34656	58715
34656	61638
34657	58716
34657	61613
34658	61612
34671	58717
34671	61614
34671	G63717
34671	77717

Monroe	GRC
34671	58717
34672	G63717
34672	77717
34672	61614
34672	58717
34673	58778
34673	61638
34675	58783
34675	61641
34676	58662
34676	61600
34677	61643
34678	61642
34684	58807
34684	61653
34685	58808
34685	61654
34685	77808
34686	58809
34686	61655
34686	61657
34687	58810
34687	61656
34687	61682
34687	77810
34689	61641
34690	61642
34692	58930
34693	61675
34694	61675
34694	61642
34694	G63866
34694	77953
34694	81930
34694	58930
34729	58410
34729	61520
34729	61546
34730	61520
34732	61614
34733	58617
34733	G63617
34736	58394
34736	61525
34736	G63394
34737	61557

INTERCAMBIO MONROE VS GRC

Monroe	GRC
34740	61531
34740	81516
34740	58423
34740	G63423
34740	77423
34741	61544
34750	61523
34751	61590
34755	58812
34755	G63812
34756	61543
34759	58623
34759	61595
34760	61591
34761	61646
34762	61686
34763	58638
34763	61565
34763	61687
34767	61688
34776	58661
34776	61599
34777	61600
34778	58673
34778	61634
34781	58675
34781	61642
34782	58674
34782	61635
34782	58674
34782	61635
34782	G63674
34782	77674
34787	G63615
34788	G63616
34791	G63692
34793	61520
34793	G63909
34794	61523
34796	61591
34797	61547
34798	58609
34798	61542
34798	77609
34799	61542
34803	61500

Monroe	GRC
34803	77405
34803	G63405
34803	G63949
34804	61623
34804	G63678
34804	77678
34804	81893
34810	G64148
34811	58943
34817	58355
34817	61525
34821	61547
34822	G63306
34822	G63371
34824	58349
34824	58438
34824	61524
34828	G63510
34831	61523
34832	61526
34839	61517
34853	58183
34853	61632
34854	61633
34868	61650
34899	58500
34899	61553
34900	58386
34900	61521
34901	58387
34901	61647
34901	G63387
34904	61637
34905	61500
34906	61521
34906	G63396
34907	61551
34907	G63447
34909	G63187
34909	G63398
34910	58413
34910	61522
34910	81496
34911	58350
34911	61518
34912	58625

Monroe	GRC
34912	G63625
34919	58411
34919	G63411
34920	58412
34920	61642
34926	58414
34927	58409
34927	61554
34928	58416
34928	G63416
34929	58403
34929	58671
34929	G63403
34929	G63671
34930	58461
34930	58811
34930	61530
34930	61657
34930	G63811
34934	61528
34944	58437
34944	61516
34945	61504
34945	G63421
34945	77421
34945	81750
34945	58421
34953	61509
34953	81541
34953	G63903
34954	61513
34954	G63900
34958	58377
34958	61519
34958	77377
34958	G63377
34959	61507
34960	58366
34960	61649
34963	58406
34963	61547
34964	58456
34964	61530
34968	61501
34968	61508
34970	69861

Monroe	GRC
34971	69858
34975	61551
34983	58489
34983	61544
34984	G63841
34985	58488
34985	61543
37011	G63414
37012	G63603
37013	77525
37013	G63427
37013	G63525
37013	G63773
37014	77524
37014	G63420
37014	G63524
37014	G63775
37015	G63608
37015	G63614
37016	G63635
37017	G63639
37019	58421
37019	G63421
37019	77421
37019	61504
37019	81750
37021	58422
37021	G63422
37022	G63495
37022	G63611
37024	61586
37024	G63610
37026	G63424
37026	G63721
37027	61536
37027	77425
37027	G63425
37028	G63904
37029	77492
37029	G63928
37030	77479
37030	77903
37030	G63479
37030	G63547
37030	G63903
37031	G63404

INTERCAMBIO MONROE VS GRC

Monroe	GRC
37031	G63444
37032	77494
37032	G63494
37033	G63548
37034	G63414
37035	77607
37035	G63607
37035	G63679
37036	G63410
37037	G63409
37038	G63461
37039	G63461
37040	G63347
37040	G63437
37041	77349
37041	77662
37041	G63349
37041	G63366
37041	G63438
37042	G63906
37044	G63488
37045	77183
37045	G63183
37046	77389
37046	G63389
37047	G63902
37048	G63492
37049	77355
37049	G63355
37050	G63489
37051	G63490
37052	G63406
37053	G63386
37055	77455
37055	G63455
37058	G63457
37060	G63621
37061	G63502
37062	G63818
37063	61555
37063	77375
37063	81713
37063	G63375
37064	77454
37064	G63454
37065	G63426

Monroe	GRC
37066	77915
37066	G63915
37067	G63460
37068	77958
37068	G63881
37068	G63905
37069	G63499
37070	G63799
37071	G63914
37072	77418
37072	G63418
37072	G63903
37073	G63173
37073	G63419
37073	G63907
37074	G63620
37075	G63606
37076	G63640
37077	77902
37077	77909
37077	G63909
37078	77907
37078	G63907
37080	58624
37080	G63624
37081	61535
37081	77424
37081	G63424
37082	G63626
37082	G63683
37083	G63424
37083	77424
37083	61535
37083	81548
37085	G63896
37086	77638
37086	G63638
37086	G63897
37087	G63638
37088	G63500
37089	G63350
37090	77357
37090	G63357
37091	G63413
37093	G63359
37094	58353

Monroe	GRC
37094	G63353
37095	G63414
37097	G63950
37098	G63299
37099	58423
37099	G63423
37100	G63904
37101	77660
37101	G63660
37102	77359
37102	G63359
37102	G63661
37103	G63413
37103	G63662
37104	G63673
37104	G63674
37105	G63662
37108	G63707
37109	G63708
37110	G63676
37110	G63873
37111	77937
37111	G63937
37112	G63689
37113	G63494
37113	61700
37114	G63494
37114	61699
37116	G63386
37117	77623
37117	G63623
37118	G63414
37120	G63511
37121	G63490
37122	G63678
37123	G63690
37125	G63489
37128	58622
37128	58929
37128	G63929
37129	G63421
37130	G63609
37130	G63818
37131	G63714
37132	77778
37132	G63778

Monroe	GRC
37133	77716
37133	G63716
37134	G63715
37135	G63722
37137	G63915
37138	G63403
37140	G63403
37144	G63717
37144	61614
37144	G63717
37144	77717
37144	58717
37145	G63717
37146	G55821
37147	G63778
37148	G63715
37149	G63783
37150	G63662
37150	77662
37150	61600
37150	81873
37150	58662
37151	G63803
37152	G63675
37153	77772
37153	G63772
37154	G63717
37155	G63676
37156	G63776
37156	G63869
37157	77726
37157	G63726
37158	61609
37158	G63712
37159	G63611
37160	G63710
37161	G63847
37162	G63829
37163	G63817
37163	G63783
37163	77783
37164	G63675
37166	77953
37166	G63866
37172	G63492
37172	77492

INTERCAMBIO MONROE VS GRC

Monroe	GRC
37172	61506
37177	77678
37177	G63678
37178	G63803
37178	77803
37178	61643
37178	81922
37178	58803
37181	77817
37181	G63817
37181	61663
37181	81925
37181	58817
37187	82035
37189	82046
37191	G63506
37191	G63615
37195	69581
37196	69582
37198	G63694
37199	61651
37199	69813
37199	G63860
37202	61703
37202	G64002
37203	G63844
37204	G63845
37206	G63958
37207	G63675
37207	61692
37207	58412
37207	77412
37208	77947
37208	G63848
37217	69900
37217	G63862
37218	G63877
37218	69909
37219	G64049
37220	G63905
37231	G63720
37232	G63506
37233	G63506
37234	G63694
37237	69907
37237	G51705

Monroe	GRC
37238	G63815
37239	77815
37239	G63815
37240	G64087
37241	G63842
37242	61717
37242	G64014
37243	G63610
37244	69782
37244	G63864
37245	61662
37246	61704
37246	G64003
37249	G63434
37251	G63878
37252	G63883
37253	G63875
37269	G64105
37270	G63885
37272	70000
37273	G64031
37274	G64033
37279	G64004
37279	G64005
37279	G63889
37280	G64007
37280	G64006
37281	G64032
37282	G51798
37283	G51803
37284	G51805
37285	61711
37285	G64008
37286	61696
37286	G63966
37286	G63967
37287	61697
37288	70010
37289	G64026
37290	G64042
37298	G64038
37301	G51804
37302	G64037
37307	G64071
37308	G64052
37309	G64080

Monroe	GRC
37310	G511004
37312	G51831
37313	G64056
37314	G64072
37315	G64040
37316	G64133
37317	G51884
37318	G64047
37319	69582
37319	G64090
37320	G63907
37320	61500
37320	81147
37320	70163
37321	69580
37321	70159
37321	69580
37322	G64048
37323	70078
37324	G64077
37326	G51966
37327	G51957
37328	G64050
37329	G64113
37331	G64072
37336	G51989
37338	G64056
37339	G64104
37803	G63306
39001	69807
39001	69995
39002	69996
39003	G51161
39004	69677
39012	69773
39013	69877
39014	69878
39016	G51711
39020	69952
39021	69966
39027	70024
39040	70040
39041	69878
39042	69950
39042	70064
39043	69951

Monroe	GRC
39043	70065
39044	69956
39045	69957
39046	69877
39047	70033
39047	70057
39050	70057
39051	G64046
39052	61777
39052	G63868
39101	70023
39102	69946
39104	G51891
39105	G51870
39107	70034
39108	70093
39109	70094
39110	70092
39111	G511001
39112	G51949
39131	G51921
39132	G51920
39133	G51922
39136	G51901
40016	G56775
40017	G56776
40046	G56664
58253	34058
58273	34073
58428	43143
58510	43140
58518	43099
58523	43162
58527	43062
58551	43084
58552	43107
58567	43048
58567	43093
58574	43049
58574	43060
58577	43067
58577	43096
58578	43111
58592	43058
58595	43085
58598	43161

INTERCAMBIO MONROE VS GRC

Monroe	GRC
58600	43163
58602	43142
58608	43165
58608	43167
58612	43180
58617	43171
58617	43172
58624	43173
58636	43181
63618	143058
63619	143061
63622	143060
63628	143064
63973	143057
63975	143062
65102	61672
65167	G63969
65167	58944
65168	77968
65174	G63963
65174	58945
66400	G63432
66415	G63918
66618	G63510
66639	G63610
66642	G63866
66717	G63616
66801	G63484
66858	G63183
71026	G56978
71027	G56979
71029	G52048
71030	G56741
71031	G56740
71032	G51730
71034	G52045
71035	G52044
71036	G56692
71037	G56693
71039	G52040
71040	G52043
71041	G51894
71042	G52046
71042	G52047
71048	G52213
71055	G52217

Monroe	GRC
71058	G52585
71100	G51815
71101	G51858
71102	G51766
71103	G51765
71105	G51854
71106	G51853
71107	G51958
71108	G51959
71109	G52037
71110	G52036
71111	61712
71111	G51758
71112	G51881
71113	G51767
71114	G51830
71115	G51825
71116	G511020
71116	G511023
71117	G511019
71117	G511022
71119	G51855
71120	G51849
71122	G51923
71123	G51924
71124	G52205
71124	G56838
71125	G52206
71125	G56839
71126	G51863
71128	G52131
71130	G52118
71131	G52117
71133	G56598
71134	G56599
71135	G52248
71136	G52247
71137	G51937
71138	G51860
71139	G51861
71140	G51865
71141	G51864
71145	G51882
71146	G51838
71147	G511087
71148	G51909

Monroe	GRC
71202	G51006
71204	G51047
71205	G51047
71206	G51330
71207	G51013
71210	G51229
71210	G51232
71211	G51424
71212	G51027
71214	G51197
71215	G51193
71216	G51165
71217	G51031
71218	G51034
71218	G51170
71220	G51060
71221	G51030
71222	G51182
71222	G51183
71223	G51173
71225	G51039
71227	G55743
71228	G55766
71229	G55757
71230	G51180
71231	G55771
71231	G55803
71233	G51191
71234	G51249
71235	G51186
71237	G51192
71238	G55782
71239	G51033
71242	G51184
71243	G51046
71245	G51196
71246	G51188
71246	G51189
71247	G51190
71253	G51346
71254	G56591
71255	G55769
71256	G55804
71259	G55952
71260	G55788
71265	G51022

Monroe	GRC
71266	G55803
71267	G55805
71268	G51181
71276	G51712
71277	G51253
71278	G51230
71281	G55825
71282	G51078
71285	G51195
71286	G55786
71289	G51290
71290	G51204
71291	G55909
71292	G55910
71293	G51087
71294	G51252
71296	G51254
71297	G55890
71299	G55871
71303	G51097
71304	G51099
71305	G51101
71308	G51100
71309	G51759
71311	G51268
71312	G51279
71313	G51254
71316	G55796
71317	G56592
71318	G56593
71319	G51007
71321	G51722
71322	G51724
71323	G56566
71325	G51256
71326	G51713
71327	G51727
71331	G51740
71332	69586
71334	G51742
71335	G51743
71340	G51700
71340	G51716
71341	G51718
71342	G56596
71343	G56597

INTERCAMBIO MONROE VS GRC

Monroe	GRC
71344	G51756
71345	G51757
71346	79900
71346	G51887
71347	G51477
71348	G51869
71348	G51477
71349	G51216
71350	69998
71351	G51868
71352	G51077
71353	G51850
71354	G56557
71355	G51744
71356	G51841
71358	G51715
71359	G51279
71360	G51772
71361	G51704
71362	G51703
71363	G56587
71364	G51899
71366	G51769
71367	G51773
71369	G51719
71369	G51720
71370	G51729
71371	G51739
71372	G51738
71373	G51736
71375	G51768
71376	G51840
71377	G56807
71379	G51794
71380	G51286
71386	G56594
71387	G56595
71390	G51746
71391	G52276
71398	G51723
71400	G56522
71400	G56896
71401	G56522
71401	G56895
71404	G56540
71405	G56539

Monroe	GRC
71406	G56641
71407	G56640
71410	G56545
71411	G56546
71412	G55865
71412	G56543
71413	G55866
71413	G56544
71414	G55867
71415	G55868
71416	G56691
71417	G51714
71418	G56684
71419	G56683
71420	G56531
71421	G56532
71422	G56533
71423	G56534
71424	G56633
71425	G56634
71426	G56672
71427	G56671
71433	G56622
71434	G56621
71435	G56561
71436	G56562
71437	G55994
71438	G55993
71439	G56588
71440	G56589
71441	G56688
71442	G56687
71443	G55857
71444	G55858
71445	G56541
71446	G56542
71447	G56555
71448	G56556
71451	G56758
71452	G56759
71453	G56581
71454	G56582
71455	G56608
71456	G56608
71457	G56607
71458	G56607

Monroe	GRC
71459	G56624
71460	G56625
71461	G56686
71462	G56685
71467	G56531
71468	G56532
71469	G56611
71470	G56760
71471	G56761
71472	G56762
71473	G56763
71474	G56764
71475	G56765
71476	G56766
71477	G56767
71478	G56768
71479	G52637
71480	G52636
71483	G52080
71484	G52079
71485	G56802
71486	G56791
71488	G56792
71490	G56674
71491	G56673
71492	G56676
71493	G56675
71494	G56680
71495	G56679
71496	G56668
71497	G56667
71498	G56682
71499	G56681
71503	G56769
71504	G56517
71505	G56516
71515	G56603
71516	G56602
71517	G56612
71518	G56612
71523	G56605
71524	G56604
71525	G56606
71526	G56770
71527	G56771
71530	G55797

Monroe	GRC
71538	G51709
71539	G51710
71545	G56569
71546	G56570
71547	G56571
71548	G56637
71549	G56525
71550	G56526
71551	G52336
71551	G56527
71552	G52335
71552	G56528
71553	G56529
71554	G56530
71555	G56795
71556	G56796
71557	G56576
71558	G56573
71559	G56574
71560	G56575
71561	G51227
71562	G56786
71563	G56787
71565	G51267
71566	G56619
71567	G56618
71568	G56784
71569	G56785
71570	G56736
71571	G56739
71572	G56620
71573	G56616
71574	G56615
71575	G56572
71576	G55603
71577	G51728
71578	G55894
71579	G55893
71580	G55892
71581	G56751
71581	G56753
71581	G56755
71581	G56757
71582	G56750
71582	G56752
71582	G56754

INTERCAMBIO MONROE VS GRC

Monroe	GRC
71582	G56756
71583	G51255
71584	G56523
71584	G56898
71585	G56524
71585	G56897
71586	G56535
71587	G56536
71588	G56537
71589	G56538
71590	G56518
71591	G56518
71592	G55896
71593	G56568
71594	G56601
71595	G56690
71596	G56689
71597	G56558
71598	G56559
71599	G56565
71600	G55923
71600	G55925
71601	G55924
71601	G55926
71602	G55933
71603	G55934
71604	G55931
71605	G55932
71606	G55927
71607	G55928
71608	G55929
71609	G55930
71610	G56579
71611	G56580
71612	G55859
71613	G55860
71615	G55960
71615	G55978
71616	G55901
71617	G56719
71618	G56720
71619	G55776
71620	G55776
71628	G55670
71629	G55671
71632	G56701

Monroe	GRC
71638	G55911
71639	G55911
71642	G51063
71644	G55849
71645	G55849
71646	G55850
71647	G55850
71648	G56626
71649	G56627
71650	G56628
71651	G56629
71654	G55879
71655	G55879
71656	G56513
71657	G56512
71660	G55672
71661	G55948
71662	G55949
71663	G55831
71664	G55878
71665	G56508
71667	G55664
71668	G55663
71669	G55856
71670	G55948
71671	G55949
71672	G55974
71673	G55975
71674	G55833
71675	G55832
71676	G55668
71677	G55669
71678	G56514
71679	G56506
71680	G55676
71681	G55675
71682	G55912
71683	G55913
71684	G56509
71686	G56501
71687	G56520
71691	G55870
71693	G55881
71694	G55882
71695	G55883
71696	G55884

Monroe	GRC
71697	G55819
71698	G55820
71699	G56612
71708	G55505
71716	G56503
71718	G55705
71725	G55706
71726	69884
71726	G55707
71728	G56700
71737	G55511
71738	G55509
71748	G55713
71750	G55708
71751	G55722
71751	G55733
71752	G55712
71756	G55510
71757	G55515
71758	G44773
71758	G55516
71760	G55752
71761	G55727
71762	G55729
71771	G55514
71775	G55715
71776	G55715
71779	G55714
71780	G55616
71781	G55518
71785	G55737
71786	G55738
71791	G55534
71792	G55521
71792	G55745
71793	G55531
71793	G55546
71793	G55561
71794	G55716
71795	G55725
71795	G55731
71798	G56707
71798	G56903
71799	G56726
71800	G56703
71801	G56704

Monroe	GRC
71803	G55551
71804	G55542
71805	G55749
71806	G55719
71807	G55723
71808	G55527
71809	G56705
71810	G56706
71814	G55512
71814	G55593
71818	G55615
71819	G55526
71820	G55992
71822	G56718
71824	G55529
71825	G55529
71828	G56504
71829	G55742
71830	G55763
71831	G56708
71833	G55525
71837	G55600
71838	G55601
71839	G55584
71844	G55773
71844	G55787
71845	G55579
71846	G55557
71847	G55557
71848	G55904
71849	G55903
71850	G56713
71850	G56716
71851	G55891
71852	G55772
71853	G55990
71854	G56669
71854	G56670
71854	G56717
71857	G55591
71858	G55591
71859	G55590
71860	G55590
71861	G55589
71862	G55589
71863	G55730

INTERCAMBIO MONROE VS GRC

Monroe	GRC
71863	G55770
71865	G55580
71866	G55580
71868	G55587
71868	G55605
71868	G55609
71868	G55945
71869	G55592
71870	G55781
71871	G55658
71872	G55657
71873	G55976
71874	G55977
71876	G55784
71877	G55785
71878	G55847
71880	G55848
71881	G55608
71882	G55607
71885	G55780
71887	G55673
71888	G55602
71888	G55710
71889	G55544
71893	G55606
71894	G55606
71897	G51796
71897	G55818
71898	G55828
71899	G55828
71900	G55921
71901	G55920
71902	G55586
71904	G55653
71905	G55652
71912	G55539
71913	G56714
71916	G55611
71917	G55610
71918	G55891
71920	G55685
71921	G56724
71922	G56723
71923	G55533
71924	G55801
71925	G55800

Monroe	GRC
71926	G56705
71927	G56706
71932	G56518
71933	G35066
71933	G55991
71936	G55672
71937	G55664
71938	G55663
71939	G55665
71940	G55989
71941	G55666
71942	G55667
71943	G55668
71944	G55669
71945	G55802
71946	G55802
71951	G55999
71952	G55999
71953	G55662
71954	G55661
71959	G55679
71960	G55680
71963	G55681
71963	G56790
71964	G55697
71965	G56715
71968	G55971
71969	G55970
71972	G55817
71973	G55698
71976	G51770
71977	G51771
71979	G56502
71980	G56502
71981	G51264
71981	G55795
71982	G55795
71983	G55692
71984	G55693
71985	G55692
71986	G55693
71987	G55615
71989	G55877
71991	G35098
71992	G56515
71993	G56801

Monroe	GRC
71994	G55848
71996	G55951
71997	G55958
71998	G56577
72101	G56547
72102	G56548
72103	G56553
72104	G56554
72105	G56805
72106	G56806
72107	G52056
72108	G52055
72109	G52228
72110	G52227
72111	G56585
72112	G56586
72113	G55834
72114	G56660
72115	G56661
72116	G52014
72117	G52013
72118	G52078
72119	G52077
72120	G56781
72121	G56782
72122	G56655
72123	G51737
72126	G56632
72127	G56631
72130	G56772
72135	G52113
72136	G52112
72138	G56817
72139	G56635
72140	G56636
72142	G56894
72143	G56799
72144	G56800
72147	G56551
72148	G56552
72158	G56803
72159	G56804
72162	G52074
72163	G52073
72170	G52035
72171	G52034

Monroe	GRC
72177	G56812
72179	G56810
72183	G52435
72184	G52436
72185	G56678
72186	G56677
72191	G56643
72192	G56642
72193	G56645
72194	G56644
72195	G51811
72196	G51810
72199	G52029
72200	G52028
72201	G52124
72201	G56815
72202	G52123
72202	G56816
72203	G56809
72205	G56722
72206	G56721
72207	G56729
72208	G56728
72209	G56774
72210	G56773
72211	G56731
72212	G56730
72213	G56735
72214	G56734
72215	G56733
72216	G56732
72217	G52027
72218	G52026
72219	G56820
72220	G56819
72221	G56821
72222	G56822
72229	G52141
72230	G52140
72231	G52025
72236	G56797
72237	G56798
72238	G56793
72239	G56794
72240	G56672
72241	G56671

INTERCAMBIO MONROE VS GRC

Monroe	GRC
72242	G56814
72243	G56813
72244	G51774
72245	G52098
72246	G52016
72247	G52015
72248	G51760
72249	G51761
72250	G51814
72251	G51813
72255	G52139
72256	G52138
72257	G56837
72258	G56836
72259	G52111
72260	G52110
72261	G51859
72263	G52006
72264	G52005
72265	G52165
72266	G52164
72267	G52009
72268	G52008
72269	G56841
72270	G56840
72271	G52032
72272	G52033
72275	G52007
72276	G52004
72279	G52137
72280	G52136
72281	G51806
72282	G55914
72283	G55914
72284	G52650
72285	G52649
72286	G52039
72287	G52038
72288	G56843
72289	G56842
72290	G52153
72290	G52283
72291	G52152
72291	G52282
72292	G51856
72295	G56887

Monroe	GRC
72296	G56886
72297	G52155
72298	G52154
72299	G52159
72300	G52158
72301	G52161
72302	G52160
72303	G52163
72304	G52162
72305	G52157
72306	G52156
72307	G56888
72308	G56889
72309	G52104
72310	G52103
72311	G56899
72312	G52301
72313	G52143
72314	G52142
72315	G52275
72316	G52274
72317	G52001
72318	G52000
72319	G52003
72320	G52002
72321	G52116
72322	G52651
72322	G52652
72324	G51847
72327	G52176
72328	G52175
72334	G52031
72335	G52030
72336	G52281
72337	G52280
72339	G52145
72340	G52144
72341	G51832
72342	G51833
72343	G52151
72344	G52150
72347	G52169
72348	G52168
72349	G52363
72350	G52362
72351	G52194

Monroe	GRC
72352	G52193
72355	G52263
72356	G52262
72357	G56891
72358	G56890
72359	G52396
72360	G52395
72362	G51204
72363	G52108
72364	G52107
72365	G52106
72366	G52105
72367	G52082
72368	G52081
72371	G52064
72371	G56893
72372	G52063
72372	G56892
72373	G52018
72374	G52017
72378	G52095
72379	G52094
72382	G52179
72383	G52178
72384	G52645
72385	G52644
72390	G52097
72391	G52096
72392	G52122
72393	G52121
72394	G51795
72397	G51883
72398	G51880
72399	G51908
72400	G51852
72401	G51842
72408	G51947
72408	G51948
72412	G52072
72413	G52071
72414	G52086
72415	G52085
72416	G52090
72417	G52089
72418	G52065
72419	G52088

Monroe	GRC
72420	G52087
72421	G52084
72422	G52083
72423	G52185
72424	G52184
72425	G52181
72426	G52180
72429	G52271
72430	G52270
72433	G52250
72434	G52249
72435	G52167
72436	G52166
72437	G52300
72438	G52299
72441	G52269
72442	G52268
72443	G52261
72444	G52260
72445	G52183
72446	G52182
72447	G52430
72448	G56882
72449	G56883
72450	G56884
72451	G56885
72452	G51889
72453	G51890
72454	G51826
72457	G52376
72458	G52377
72462	G52063
72463	G52064
72464	G52021
72465	G52022
72466	G52019
72467	G52020
72471	G52244
72474	G51915
72476	G52349
72477	G52348
72478	G51928
72480	G52298
72481	G52297
72482	G51934
72483	G52202

INTERCAMBIO MONROE VS GRC

Monroe	GRC
72484	G52201
72485	G52204
72486	G52203
72489	G52381
72490	G52380
72491	G52188
72492	G52187
72493	G52210
72494	G52209
72495	G51906
72496	G51907
72497	G51879
72501	G51886
72504	G52408
72505	G52407
72506	G51926
72507	G51925
72508	G51977
72509	G52149
72510	G52148
72511	G51848
72515	G52601
72516	G52600
72517	G511089
72518	G52125
72519	G52342
72522	G52422
72523	G52423
72524	G52256
72525	G52255
72526	G52128
72527	G52127
72528	G52279
72529	G52278
72530	G52129
72531	G52130
72532	G52398
72533	G52399
72534	G52384
72535	G52385
72536	G52031
72537	G52030
72539	G51875
72539	G51876
72540	G52406
72541	G52254

Monroe	GRC
72542	G52253
72544	G52255
72545	G52256
72547	G52200
72548	G52199
72560	G52462
72561	G52461
72565	G52273
72566	G52272
72567	G51910
72568	G51985
72569	G51984
72578	G52378
72589	G55526
72590	G55526
72591	G55525
72594	G51857
72596	G51896
72596	G51897
72597	G52246
72598	G52245
72599	G51898
72601	G52211
72602	G52224
72603	G52223
72606	G52171
72607	G52170
72608	G52174
72609	G52173
72618	G52420
72619	G52421
72624	G51987
72625	G51986
72626	G52433
72626	G52470
72627	G52432
72627	G52469
72628	G511070
72629	G52623
72630	G52622
72631	G52617
72632	G52616
72633	G52218
72634	G51895
72635	G52172
72636	G52676

Monroe	GRC
72637	G52675
72638	G51963
72638	G51964
72638	G52473
72638	G52474
72640	G52661
72641	G52503
72642	G52502
72644	G52316
72645	G52011
72651	G511017
72651	G511018
72659	G52153
72660	G52152
72665	G511027
72665	G511028
72670	G52265
72671	G52264
72678	G52375
72679	G52374
72680	G52595
72681	G52594
72684	G52606
72685	G52605
72686	G52273
72687	G52272
72688	G52332
72689	G52331
72690	G511075
72692	G51919
72693	G51918
72694	G51917
72695	G51961
72696	G52596
72700	G511014
72701	G511013
72706	G52354
72707	G52353
72709	G52439
72709	G52440
72712	G52444
72712	G52514
72713	G52443
72713	G52513
72720	G52472
72721	G52471

Monroe	GRC
72730	G52358
72730	G52359
72731	G52314
72732	G52314
72733	G52314
72734	G52314
72746	G51900
72747	G51900
72755	G52143
72756	G52142
72765	G52448
72766	G52447
72770	G52641
72771	G52640
72781	G52458
72781	G52466
72781	G52660
72783	G52457
72783	G52465
72783	G52659
72826	44763
72826	G44763
72837	G44724
72852	G44723
72867	G44800
72869	G44735
72869	G44806
72870	G44748
72871	G44775
72873	G44774
72876	G44743
72880	G44802
72881	G44803
72888	G52352
72889	G52351
72890	56980
72917	G52258
72918	G52257
72922	G511016
73204	G44998
73210	G44940
73213	G44941
73214	G44747
73214	G44926
73216	G44745
73226	G44776

INTERCAMBIO MONROE VS GRC

Monroe	GRC
73226	G55746
73229	G44936
73229	G44968
73238	G44939
73238	G44943
73242	G44994
73244	G44995
73245	G44990
73255	G44997
73267	G44459
73304	G44450
73305	G44459
73309	G44969
73311	G44493
73312	G44497
73405	G44903
73453	G244002
73934	G44862
73948	G44850
73950	G44856
73951	G44938
73952	G44869
73953	G44868
73976	G44902
73995	G44767
73998	G44920
73998	G44991
139105	G57000
171140	G57132
171322	G63679
171346	G57080
171525	G57039
171616	G56936
172177	G57141
172231	G57142
172263	G57094
172264	G57093
172292	G57147
271678	G56931
271679	G56930
271680	G56933
271681	G56932
272526	G52499
272527	G52498
550011	69606
550016	G63424

Monroe	GRC
550017	G63425
550018	69574
550018	77955
550020	G63919
553001	79901
553001	G51888
553002	G56778
553003	G52343
553014	G511031
553014	G511032
555004	G63299
555005	G63689
555006	G63173
555011	G63605
555012	G63183
555031	G63929
555038	77403
801001	G56742
801002	G51295
801003	G56749
801006	G56748
801007	G56650
801008	G56649
801010	56980
801011	56980
801012	G56712
801017	G56648
801018	G56742
801019	G56742
801020	G51295
801022	56743
801022	56744
801023	G56650
801025	G52041
801028	G52042
801050	G52226
801051	G52225
801052	G52217
801241	G55786
801265	G51022
801266	G55803
801278	G51230
801281	G55825
801282	G51078
801282	M51268
801286	G55786

Monroe	GRC
801286	M55786
801291	G55909
801292	G55910
801293	G51087
801293	M51087
801296	G51254
801296	M51254
801311	G51268
801312	G51279
801351	G51077
801351	M51077
801352	G51077
801426	G56672
801427	G56671
801504	G56517
801505	G56516
801525	G56606
801565	G51267
801566	G56619
801567	G56618
801570	G56739
801570	M56739
801571	G56736
801571	M56736
801572	G56620
801578	G55894
801579	G55893
801580	G55892
801615	G55978
801615	G55960
801615	M55978
801615	M55960
801616	G55901
801617	G56719
801618	G56720
801661	G55948
801662	G55949
801663	G55831
801663	M55831
801672	G55974
801673	G55975
801673	M55975
801678	G56514
801678	M56514
801680	G55676
801681	G55675

Monroe	GRC
801682	G55912
801683	G55913
801683	M55913
801686	G56501
801687	G56520
801687	M56520
801691	G55870
801728	G56700
801728	M56700
801751	G55733
801751	M55733
801771	G55514
801798	G56903
801798	M56903
801799	G56707
801803	G55551
801809	G56705
801810	G56706
801822	G56718
801828	G56504
801828	M56504
801831	G56708
801831	M56708
801845	G55579
801845	M55579
801846	G55557
801846	M55557
801847	G55557
801847	M55557
801853	G55990
801857	G55591
801857	M55591
801858	G55591
801858	M55591
801859	G55590
801860	G55590
801861	G55589
801861	M52573
801862	G55589
801862	M52574
801871	G55658
801872	G55657
801873	G55976
801874	G55977
801875	G55774
801878	G55847

INTERCAMBIO MONROE VS GRC

Monroe	GRC
801880	G55848
801881	G55608
801881	M55608
801882	G55607
801882	M55607
801897	G51267
801900	G55921
801901	G55920
801920	G55685
801926	G56705
801927	G56706
801932	G56518
801932	M56518
801933	G35066
801933	G55991
801937	G55664
801937	M55664
801938	G55663
801938	M55663
801939	G55665
801939	M55665
801941	G55666
801942	G55667
801945	G55802
801946	G55802
801951	G55999
801952	G55999
801953	G55662
801954	G55661
801959	G55679
801960	G55680
801962	G56790
801963	G55681
801964	G55697
801968	G55971
801969	G55970
801972	G55817
801972	M55817
801973	G55698
801979	G56502
801979	M56502
801980	G56502
801980	M56502
801984	G55693
801984	M55693
801989	G55877

Monroe	GRC
801989	M55877
801991	G35098
801992	G56515
801994	G55848
802105	G56805
802106	G56806
802591	G55525
901903	142091
901904	142444
901905	141578
901907	141580
901908	142880
901908	142933
901913	142108
901913	142762
901921	142141
901921	142143
901921	142144
901922	142530
901923	142145
901924	142146
901925	142197
901926	142846
901927	142844
901929	142148
901930	142183
901933	142850
901934	142223
901938	142234
901939	142233
901940	142230
901940	142300
901940	143030
901940	143330
901940	143423
901941	142136
901941	142251
901942	142195
901943	142134
901944	143278
901946	142224
901947	142241
901948	142242
901950	142244
901951	141974
901952	142173

Monroe	GRC
901953	142132
901954	142103
901954	142254
901954	142648
901955	142133
901956	142221
901958	142249
901959	142189
901960	142196
901961	142572
901962	142250
901963	142190
901964	142245
901965	142135
901966	142252
901966	142573
901967	142247
901969	142248
901970	142222
901971	142220
901973	142225
901973	142226
901973	142227
901975	143277
901976	142301
901977	142240
901978	142292
901979	143279
901980	142842
901981	142194
901983	142307
901984	142306
901985	142734
901987	142293
901988	142295
901989	142302
901990	142298
901993	142311
901994	142294
901995	142296
901999	142852
902901	142228
902901	142229
902902	142326
902902	143086
902905	142217

Monroe	GRC
902906	142092
902907	142840
902908	142393
902910	142399
902911	142440
902912	142437
902913	142335
902915	142415
902919	142237
902920	142219
902921	142325
902922	142856
902923	142419
902924	142330
902926	142561
902927	142439
902930	142411
902930	142529
902932	142317
902935	142803
902936	142854
902937	142861
902938	142623
902939	142855
902940	142847
902944	142845
902945	142841
902946	142396
902946	143320
902947	142408
902948	142409
902949	142413
902951	142404
902952	142403
902953	142843
902954	142402
902954	142843
902958	142329
902959	142334
902960	142853
902964	142321
902965	142297
902965	142527
902967	142231
902968	143071
902968	143073

INTERCAMBIO MONROE VS GRC

Monroe	GRC
902968	143074
902969	143067
902969	143072
902970	142738
902971	142405
902972	142640
902973	142525
902973	142526
902973	143091
902977	142543
902979	142430
902980	142646
902981	142428
902982	142426
902983	142427
902984	142625
902985	142741
902986	142436
902989	142860
902989	142862
902991	143063
902992	142316
902994	143036
902995	143037
902998	142647
902999	142531
903900	142532
903901	142827
903902	142828
903903	142649
903904	142837
903905	142570
903906	142650
903907	142851
903908	143222
903909	143220
903910	142546
903911	142547
903913	142521
903914	143084
903915	142735
903916	142825
903917	142826
903918	143082
903920	143263

Monroe	GRC
903921	143262
903922	143083
903923	143259
903924	143256
903926	142932
903928	142930
903932	143240
903933	142412
903935	142535
903936	142536
903938	142935
903939	142626
903940	142642
903941	142641
903942	142643
903947	142857
903950	142936
903950	143322
903951	142859
903954	142938
903957	142939
903958	143210
903959	143208
903960	143207
903961	143206
903964	142571
903965	142744
903966	142745
903967	142746
903968	142747
903970	142748
903971	142749
903972	142750
903973	142751
903974	142752
903975	142753
903976	142754
903977	142755
903980	142568
903983	142550
903984	142763
903985	142757
903991	142836
903992	142559
903995	143367

Monroe	GRC
903997	143200
903998	143199
903999	143198
904900	142838
904902	143196
904903	142941
904904	143191
904905	142651
904907	142442
904909	142653
904910	142654
904912	142406
904912	143059
904913	142832
904915	142943
904915	143090
904916	142567
904916	142940
904918	143197
904919	143035
904927	142992
904932	143204
904934	143140
904935	143093
904935	143201
904938	143253
904942	142524
904954	143218
904955	143209
904957	143087
904958	143267
904968	143241
904970	143248
904971	143246
904972	143242
904973	143317
904974	143244
904975	143315
904976	143236
904977	143235
904979	142949
904980	143227
904981	143228
904983	143219
904985	143214

Monroe	GRC
904987	142942
904988	143194
904989	143202
904990	143094
904991	143193
904992	142652
904994	143223
904995	143221
904996	143264
904997	143231
904998	143112
904999	143113
905900	143195
905902	143266
905903	143255
905904	143305
905906	143239
905906	143309
905907	143323
905908	143300
905908	143355
905909	143299
905909	143354
905910	143316
905911	142931
905912	143280
905912	143281
905914	143324
905915	143341
905917	143224
905918	143392
905922	143364
905927	143226
905944	143088
905945	143284
905948	143089
905949	143368
905950	143205
905966	143369
905969	143335
905980	143363
905981	143375
905983	143342
905997	142834
906902	143289

INTERCAMBIO MONROE VS GRC

Monroe	GRC
906903	143288
906904	143285
906905	143292
906906	143287
906914	142937
906917	143321
906918	143318
906919	143265
906919	143353
906920	143233
906927	143319
906936	142556
906958	143336
906959	143337
906960	143463
906969	143352
906980	143365
906983	143404
906987	143343
907923	143339
907925	143325
907932	143358
907937	143360
907940	143361
907944	143356
907947	143345
907949	143344
908908	143116
911030	G63479
911034	77410
911034	G63410
911034	G63445
911035	77679
911035	G63679
911036	77414
911036	G63446
911037	77409
911038	77461
911038	G63439
911038	G63461
911039	77456
911039	G63456
911039	G63964
911040	58906
911040	G63906

Monroe	GRC
911042	58908
911042	G63908
911044	G63488
911044	77488
911044	61543
911044	81667
911044	58488
911050	G63489
911050	77489
911050	61544
911050	81668
911050	58489
911052	77406
911052	G63406
911080	G63624
911085	G63896
911085	G63898
911086	G63897
911091	77413
911096	G63360
911102	77661
911104	77673
911128	77608
911131	77714
911131	G63714
911132	G63778
911134	G63715
911144	77717
911144	61614
911144	G63717
911144	77717
911144	58717
911149	G63783
911149	61641
911149	81920
911149	58783
911149	77783
911150	G63662
911150	77662
911150	61600
911150	81873
911150	58662
911151	G63803
911152	G63675
911152	77412

Monroe	GRC
911152	G63675
911152	61642
911152	81921
911152	58412
911164	G63675
911171	G63813
911172	G63492
911173	77807
911173	G63622
911174	G63607
911175	77809
911175	G63809
911176	77837
911176	G63837
911178	77803
911178	G63803
911178	61643
911178	58803
911178	81922
911181	77817
911181	G63817
911183	G63832
911184	G63828
911186	77954
911186	G63958
911186	G64009
911187	G63961
911187	G63962
911192	77675
911193	77674
911193	58674
911193	61635
911193	G63674
911193	77674
911194	G63808
911196	G63810
911220	77905
911220	G63905
911221	77949
911222	G63970
911222	G63971
911223	G64011
911223	77948
911225	G64027
911226	G64028

Monroe	GRC
911228	G63882
911229	G63884
911229	G64053
911230	G63879
911245	G63813
911251	G63878
911252	G63883
911255	61683
911255	61684
911255	G63894
911256	G63893
911257	G63895
911258	61718
911258	G63872
911258	G64015
911259	G64016
911260	G63892
911261	G63870
911262	G63867
911262	G64079
911265	61713
911265	G64010
911266	77951
911266	G63886
911267	G63887
911268	77952
911268	G63888
911270	G63885
911270	G64029
911270	G64030
911273	G64031
911274	G64033
911275	69595
911276	69594
911277	G63890
911277	G63891
911278	G64012
911279	G63889
911298	G64038
911299	G64044
911300	G64043
911303	G64121
911304	G511000
911304	G511038
911330	G64103

INTERCAMBIO MONROE VS GRC

Monroe	GRC
911331	G64134
911331	G64135
911332	G64079
911447	G52430
911501	77803
911502	77412
911503	77783
911505	81922
911505	81930
911505	G63803
911505	61643
911505	58803
911505	77803
911506	77953
911506	G64101
911506	77975
911507	G63817
911507	77817
911507	61663
911508	G64000
911509	77971
911510	61717
911510	G64014
911512	77488
911513	77489
911514	77423
911516	77421
911517	77422
911521	77715
911522	77847
911523	77829
911525	77683
911527	G64001
911528	G63965
911533	61690
911533	G63959
911533	77976
911534	G64011
911535	G64013
911536	G64008
911538	G63966
911539	G63967
911541	77979
9039005	142569
171119L	G57123

Monroe	GRC
171119R	G57124
171348L	G57027
171348R	G57027
171351L	G57065
171351R	G57066
171371L	G57133
171371R	G57134
271662L	G56924
271662R	G56925
32075R	70169
32266R	61543
32303R	81892
32327R	81873
32390R	81933
5673	G51990
AK63	142150
MA700	49205
MA704	49110
MA705	49105
MA706	49157
MA708	49135
MA717	49152
MA719	49128
MA726	49173
MA727	49151
MA730	49127
MA743	49155
MA750	49346
MA751	49131
MA757	49106
MA757	49149
MA758	49215
MA759	49213
MA763	49216
MA764	49218
MA765	49226
MA768	49221
MA769	49207
MA769	49223
MA771	49214
MA772	49217
MA772	49241
MA773	49197
MA774	49229
MA776	49225

Monroe	GRC
MA776	49232
MA777	49178
MA779	49231
MA780	49193
MA784	49369
MA785	49304
MA789	49334
MA791	49345
MA793	49196
MA802	49309
MA803	49307
MA805	49114
MA809	49370
MA810	49199
MA811	49371
MA813	49381
MA817	49212
MA822	49228
MA822	49255
MA824	49230
MA828	49235
MA829	49237
MA830	49616
MC-826	44763
MC-888	44902
MC-949	G44752
MW-004	56630
MW-004	G35098
MW-005	51294
MW-005	G51294
MW-009	55991
MW-009	G56999
MW-013	51091
MW-013	G51735
MW-014	G51731
MW-015	G56694
MW-016	G56982
MW-016	G56983
MW-202	51006
MW-208	G51017
MW-265	51022
MW-748	55713
MW-749	55713
MW-751	G55733
MW-771	55514

Monroe	GRC
MW-779	G55714
MW-815	55745
MW-816	55746
MW-817	55746
MW-819	55526
MW-853	55991
MW-871	55658
MW-872	55657
MW-873	55976
MW-874	55977
MW-933	55991
SC2911	6804SE
SC2912	14016
SC2912	6857SE
SC2912	6802SE
SC2913	14017
SC2914	6852SE
SC2914	6853SE
SC2915	6802SE
SC2916	6803SE
SC2928	14040
SC2928	6804SE
SC2936	6801SE
SC2937	6851SE
SC2939	6848SE
SC2942	6807SE
SC2953	6804SE
SC2955	6826SE
SC2958	14077
SC2960	6846SE
SC2961	6828SE
SC2961	6854SE
SC2961	6855SE
SC2962	14071
SC2963	6853SE
SC2964	6847SE
SC2965	6856SE
SC2967	14072
SC2968	14076



Gama de Productos GRC® Autopartes

MAT HOLDINGS, INC.



Suspensión

- Amortiguadores y struts para Autos, Camionetas y SUV's.
- Amortiguadores para Equipo Pesado.
- Amortiguadores de Dirección.

GRC[®]
THE ORIGINAL



Frenos

- Pastillas de freno para Autos, Camionetas y SUV's.

GRC Ultra[®]
PASTILLAS DE FRENO PREMIUM



Equipo y Herramientas

- Compresores estacionarios rotativos.
- Bombas de 1 y 2 etapas.
- Kits de Mantenimiento.

Industrial Air.



Cuidado e iluminación del Auto

- Iluminación y Plafonería.
- Productos para el cuidado del Auto.

TIGER[®]
ACCESSORY GROUP

BLAZER **Clean-Rite** **WAXING CHOICE**

SOPORTE TÉCNICO

¿DUDAS? CONSULTE A LOS EXPERTOS

01 800 12 27 846

Atención de: 8:30 am - 6:00 pm



www.grcautopartes.com.mx | clientesgrcautopartes@gabriel.com

Con el **SOPORTE TÉCNICO GRC**, usted nunca recibirá mensajes grabados, solamente respuestas de nuestros expertos. Para conocer más sobre GRC Autopartes y sus productos, visite nuestra página web www.grcautopartes.com.mx y redes sociales, consulte las preguntas frecuentes, artículos, boletines técnicos y videos detallados para obtener las respuestas que necesita para hacer el trabajo correctamente.

GRC[®]

THE ORIGINAL

Distribuidor Autorizado:

Atención al Cliente y Oficina Comercial

442 278 12 59

Lunes - Viernes 8:30 am - 6:00 pm

Descarga nuestra app:

Disponible a partir
de Agosto 2017
para Android y iOS



Ride Control Mexicana S de RL de CV
El Tepeyac 1770, Parque Industrial El Tepeyac,
El Marqués, Querétaro, C.P. 76250.

Visita nuestra página WEB y redes sociales:

www.grcautopartes.com.mx



Esta guía rápida puede ser usada únicamente para especificar y vender productos de Ride Control Mexicana, sus subsidiarios y sus compañías afiliadas. Si se usa para especificar o vender otros productos es una violación de los derechos de autor.

Jun.2017

© 2017 Ride Control Mexicana

