



CATÁLOGO MASTER 2018 - 2019

Soportes para Motor y Transmisión
Bases para Amortiguador
Cubre Polvos
Misceláneos

Transmission & Motor Mounts
Strut Mounts
C.V. Boots
Automotive Rubber Parts



¡ Tu Soporte en el Camino !

Política de Calidad

Ofrecer productos y servicios para el mercado de repuesto automotriz que cumplan con los requisitos de los clientes, así como del marco legal, promoviendo una cultura de mejoramiento continuo hacia la eficacia de la operación de nuestro Sistema de Gestión de la Calidad, manteniendo una constante atención a nuestros clientes para lograr objetivos comunes de crecimiento y rentabilidad, a través del concepto innovador de una capacitación continua y permanente hacia nuestro personal, clientes y usuarios.

Misión

Como comercializadores de autopartes de repuesto, ofrecer a nuestros clientes productos y servicios de calidad con soluciones adecuadas a sus necesidades, manteniendo con ellos una constante interacción para lograr objetivos comunes de crecimiento y rentabilidad en un marco de beneficio mutuo y que, mediante la óptima realización de este concepto de negocios, podamos garantizar a nuestros colaboradores un constante desarrollo personal y profesional.

Visión

Consolidarnos en el corto plazo como la marca líder en nuestra especialidad en el mercado nacional, buscando en el mediano plazo ser la marca mexicana de mayor presencia y participación en el mercado de Norte, Centro y Sudamérica y que a través de todos los atributos de nuestro concepto comercial, podamos establecer representaciones permanentes en estos territorios.



ACURA

CL.....	1
CSX.....	2
EL.....	3
IL-X.....	3
INTEGRA.....	4
MDX.....	4
RDX.....	6
RSX.....	6
SLX.....	7
TL.....	8
TLX.....	9
TSX.....	10

AUDI

A1.....	13
A3.....	14
A3 QUATTRO.....	17
A4.....	17
A4 QUATTRO.....	19
A6.....	20
A4 QUATTRO.....	22
ALLROAD QUATTRO.....	22
Q3.....	23
RS4.....	23
RS6.....	24
S4.....	24
S6.....	24
TT.....	25
TT QUATTRO.....	26
VARIOS.....	27

BMW

128i.....	29
135i.....	29
316i.....	29
318D.....	30
318i.....	30
318is.....	30
320i.....	30
323ci.....	30
323i.....	31
323is.....	31
325i.....	31
325is.....	31
325ix.....	31
328i.....	31
328xi.....	31
330ci.....	33
330i.....	33
335i.....	33
335xi.....	33
525L.....	33
528i.....	33
528ix.....	34
530i.....	34
535i.....	35
535ix.....	35
540i.....	35

CONTINUACION...

BMW

704il.....	36
728i.....	36
730i.....	36
735i.....	36
735il.....	36
740i.....	37
740il.....	37
750i.....	37
750il.....	37
M5.....	38
SERIE 3.....	38
SERIE 5.....	38
X3.....	39
X5.....	39
Z3.....	40
Z4.....	40
Z4i.....	41
Z4il.....	41

BUICK

ALLURE.....	43
ELECTRA.....	44
ENCLAVE.....	45
ENCORE.....	45
LACROSSE.....	46
LE SABRE.....	47
LUCERNE.....	49
PARK AVENUE.....	49
REGAL.....	50
RENDEZVOUS.....	53
RIVERA.....	54
SKYHAWK.....	54
SKYLARK.....	55
SOMERSET.....	56
TERRAZA.....	56
VERANO.....	57

CADILLAC

BLS.....	59
CIMARRON.....	59
CTS.....	60
DEVILLE.....	60
ESCALADE.....	61
FLEETWOOD.....	62
SEVILLE.....	63
SRX.....	63
STS.....	64
XTS.....	64

CHEVROLET

ACADIA.....	67
ASTRA.....	67
ASTRO.....	70

CONTINUACION...

CHEVROLET

ASUNA.....	71
AUTOS.....	72
AVALANCHE.....	72
AVEO.....	73
BELAIR.....	75
BERETTA.....	76
BISCAYNE.....	78
BLAZER.....	79
C-10.....	82
C-15.....	86
C-20.....	87
C-25.....	89
C-30.....	89
C-35.....	91
C-50.....	91
C-60.....	92
C-80.....	92
C-85.....	92
C-1500.....	93
C-2500.....	94
C-3500.....	96
C-4500.....	99
CAMARO.....	99
CAMARO Z28.....	100
CAMIONETAS.....	102
CAMIONETAS 3/4	
A 1 TONELADA.....	104
CANYON.....	104
CAPRICE.....	104
CAPTIVA.....	106
CAVALIER.....	106
CAVALIER Z24.....	109
CELEBRITY.....	112
CENTURY.....	114
CHEVELLE.....	119
CHEVY.....	120
CHEVY II.....	123
CHEVY NOVA.....	124
CHEYENNE.....	125
CITATION.....	126
CITATION II.....	129
COBATL.....	129
COLORADO.....	131
CORSA.....	131
CORSICA.....	133
CORVETTE.....	136
CRUZE.....	136
CUTLASS.....	138
CUTLASS CALAIS.....	141
CUTLASS CIERRA.....	143
CUTLASS SUPREME.....	147
DENALI.....	148
ENVOY.....	149
EQUINOX.....	150
EXPRESS.....	151
GEO.....	152
HHR.....	152
HUMMER H2.....	154
IMPALA.....	154
IMPALA SS.....	159

CONTINUACION... CHEVROLET

INTRIGUE.....	159
JIMMY.....	159
LUMINA.....	161
LUMINA APV.....	163
LUMINA VAN.....	163
LUV.....	163
MALIBU.....	164
MATIZ.....	169
MERIVA.....	171
MICROBUS.....	173
MONTECARLO.....	173
NOVA.....	176
OPTRA.....	177
PICK UP.....	178
RAINIER.....	178
S-10.....	179
S-15.....	181
SAFARI.....	184
SAVANA.....	185
SERIES K.....	186
SERIES K-10.....	186
SERIES K-15.....	187
SERIES P-20.....	187
SERIES P-25.....	187
SERIES P-30.....	188
SERIES P-35.....	188
SERIES T-10.....	188
SIERRA.....	189
SILVERADO.....	191
SONIC.....	193
SONOMA.....	193
SONORA.....	195
SPARK.....	196
SS-400.....	197
SUBURBAN.....	198
TAHOE.....	201
TERRAIN.....	203
TIGRA.....	203
TODOS LOS MODELOS.....	204
TORNADO.....	204
TRACKER.....	206
TRAIL BLAZER.....	208
TRAX.....	209
TRAVERSE.....	209
UPLANDER.....	210
VARIOS.....	211
VECTRA.....	212
VENTURE.....	214
YUKON.....	215
ZAFIRA.....	217

CHRYSLER

200.....	221
300.....	222
300-C.....	223
300-M.....	224
600.....	225

CONTINUACION... CHRYSLER

800.....	226
ARIES.....	226
ASPEN.....	227
AUTOS.....	228
AVENGER.....	228
B-150, 250 Y 350 VAM.....	230
BARRACUDA.....	231
CALIBER.....	232
CAMIONETAS.....	234
CARAVAN.....	234
CARGO VAN.....	239
CHALLENGER.....	239
CHARGER.....	240
CIRRUS.....	241
CONCORDE.....	246
CORDOBA.....	247
CORONET.....	248
CROSSFIRE.....	249
D-100.....	249
D-150.....	250
D-200.....	251
D-250.....	253
D-300.....	253
D-350.....	255
DAKOTA.....	257
DART.....	258
DART K.....	259
DAYTONA.....	261
DINASTY.....	263
DURANGO.....	263
DUSTER.....	264
E CLASS.....	265
EUROPA.....	266
EXECUTIVE.....	267
GRAND CARAVAN.....	267
GRAND VOYAGER.....	272
GUAYIN.....	276
INTREPID.....	276
JOURNEY.....	278
LASER.....	280
LEBARON.....	281
LEBARON K.....	284
LERMA.....	285
LHS.....	285
MAGNUM.....	287
MAGNUM K.....	289
MONACO.....	290
NEON.....	291
NEW YORKER.....	294
NITRO.....	298
PACIFICA.....	299
PHANTOM.....	300
PICK UP.....	302
PLYMOUTH.....	303
PT CRUISER.....	304
RALLY.....	306
RAM.....	306
RAM 50.....	306
RAM 1500.....	307
RAM 2500.....	309
RAM 3500.....	311

CONTINUACION... CHRYSLER

RAM 4500.....	313
RAM CARGO VAN.....	
TRADESMAN.....	313
RAM CHARGER.....	314
SEBRING.....	315
SERIE 800 Y 900 (PERKINS).....	318
SERIE CT 800 Y CT 900 (PERKINS).....	318
SHADOW.....	319
SPIRIT.....	322
STRATUS.....	324
SUPER BEE.....	327
TOWN & COUNTRY.....	328
VALIANT.....	332
VAM.....	334
VARIOS.....	334
VOLARE K.....	335
VOYAGER.....	339

EAGLE

TALON.....	344
VISION.....	344

FIAT

PALIO.....	346
ADVENTURE.....	346

FORD

AEROESTAR.....	348
BRONCO.....	349
BRONCO II.....	350
CAMIONETAS.....	351
CLUB WAGON.....	351
CONTOUR.....	353
COUGAR.....	355
COUNTRY SQUIRE.....	358
COURIER.....	359
CROWN VICTORIA.....	361
E-100.....	362
E-150.....	363
E-200.....	365
E-250.....	365
E-300.....	366
E-350.....	368
E-450.....	369
E-550.....	370
ECOSPORT.....	370
ECONOLINE.....	371
EDGE.....	374
ESCAPE.....	374
ESCORT.....	376
EXPEDITION.....	380
EXPLORER.....	382
EXPLORER SPORT.....	383

CONTINUACION... FORD

F-100	384
F-150	389
F-200	393
F-250	394
F-350	398
F-450	404
F-500	405
F-550	405
F-600	406
F-650	406
F-700	407
F-800	407
FAIRMONT	407
FALCON	409
FIESTA	411
FIVE HUNDRED	415
FLEX	415
FOCUS (AMERICA)	416
FOCUS (EUROPA)	418
FREESTAR	419
FUSION	420
FX4	421
GALAXIE	422
GUIA	423
GRANADA	426
GRAND MARQUIS	427
IKON	428
KA	431
LOBO	432
LTD	434
MAVERICK	435
MICROBUS	435
MODIFICADOS	436
MONDEO	436
MUSTANG	438
MYSTIQUE	442
POLICE INTERCEPTOR	
UTILITY	444
PINTO	445
PROBE	445
RANGER	446
SABLE	449
SERIES E	451
SERIES F	451
TAURUS	452
TEMPO	454
THUNDERBIRD	457
TODOS LOS MODELOS	460
TOPAZ	461
TRANSIT	465
TRANSIT CONNET	466
VAM SERIES E	466
VARIOS	467
WINDSTAR	469

HONDA

ACCORD	473
CITY	477

CONTINUACION... HONDA

CIVIC	478
CL	483
CROSSTOUR	485
CR-V	486
CR-X	489
CR-Z	490
ELEMENT	491
FIT	493
INSIGHT	494
ODYSSEY	495
PASSPORT	497
PILOT	498
PRELUDE	499
RIDGELINE	500

HYUNDAI

ACCENT	501
ATOS	502
ATTITUDE	505
AZERA	506
ELANTRA	506
EXCEL	507
H-100	507
i10	507
ix35	509
SONATA	509
TUCSON	510
VELOSTER	510
VERNA	510

INFINITI

G20	513
i30	513
i35	514
QX 4	515
QX 56	515

ISUZU

AMIGO	517
ASCENDER	517
HOMBRE	518
OASIS	519
PICK UP	519
RODEO	520
TROOPER	521
UNIVERSAL	522
VEHICROSS	522

JAGUAR

S-TYPE	523
X-TYPE	523

JEEP

CHEROKEE	525
C-J	526
CJ3	527
COMANCHE	527
COMMANDER	528
COMPASS	528
GRAND CHEROKEE	531
GRAND CHEROKEE	
SPORT WAGON	534
LIBERTY	534
NITRO	535
PATRIOT	536
WAGONEER	538
WILLYS	539
WRANGER	539

KIA

AMANTI	541
RIO	541
RIO 5	542

LEXUS

ES-300	543
ES-350	543
RX-300	544
RX-330	544
RX-400H	545
RX-450H	545

LINCOLN

AVIATOR	547
CONTINENTAL	547
LS	548
MARK	548
MARK LT	548
MARS	549
MKT	549
MKX	550
MKZ	550
NAVIGATOR	551
TOWN CAR	552
ZEPHYR	553

MAZDA

2	555
3	555
5	557
6	558
323	559
626	560
B 2000 Y B 2200	560
B 3000 Y B 4000	561

CONTINUACIÓN...

MAZDA

CX-5	561
CX-7	561
CX-9	562
GLS	562
MPV MINI VAN	563
MX-3	563
NAVAJO	564
PICK UP	565
PROTEGE	565
TRIBUTE	566
VARIOS	567

MERCEDES BENZ

190 D	569
190 E	569
300-CE	569
300-E	570
300-TD	570
300-TE	570
A-140	570
A-160	571
A-190	571
A-210	571
C-32 AMG	571
C-36 AMG	572
C-43 AMG	572
C-55 AMG	572
C-180	572
C-200	573
C-220	573
C-230	573
C-240	574
C-250	575
C-280	575
C-300	576
C-320	577
C-350	577
CL-55	577
CL-63	578
CL-500	578
CL-550	578
CL-600	578
CLK-55 AMG	579
CLK-200	579
CLK-320	579
CLK-350	579
CLK-430	580
CLK-500	580
CLS-55 AMG	580
CLS-63 AMG	580
CLS-500	581
CLS-550	581
E-55 AMG	581
E-200	581
E-220	582
E-230	582
E-250	582

CONTINUACIÓN...

MERCEDES BENZ

E-280	583
E-290	583
E-300	583
E-320	584
E-350	584
E-420	585
E-430	585
E-500	585
E-550	586
G-500	586
ML-270	586
ML-320	586
ML-350	587
ML-400	587
ML-430	588
ML-450	588
ML-500	588
R-63 AMG	588
S-55 AMG	589
S-63 AMG	589
S-65 AMG	589
S-320	589
S-420	590
S-430	590
S-500	590
S-550	590
S-600	591
SL-55	591
SL-55 AMG	591
SL-65 AMG	591
SL-320	592
SL-500	592
SL-550	592
SL-600	592
SLK-200	593
SLK-230	593
SLK-280	593
SLK-300	593
SLK-320	594
SLK-350	594
SPRINTER	594

MERCURY

CAPRY	595
GRAND MARQUIS	595
LYNX	595
MARINER	596
MILAN	597
MOUNTAINEER	599
MYSTIQUE	601
MONTEGO	601
SABLE	601
TRACER	602
VILLAGER	603

MINI

COOPER	605
--------------	-----

MITSUBISHI

ASX	606
ECLIPSE	606
ENDEAVOR	608
GALANT	608
L-200	611
LANCER	611
OUTLANDER	614
PICK UP	617
VARIOS	617

NISSAN

210	619
200 SX	619
240 SX	620
620	620
720	620
ALMERA	621
ALTIMA	622
APRIO	626
ARMADA	627
CAMIONETAS	628
CUBE	628
D-21	629
D-22	631
DATSUN	632
DATSUN SEDAN	632
FRONTIER	633
GSR	635
HIKARI	636
ICHI-VAN	637
JUKE	638
LUCINO	639
MARCH	641
MAXIMA	643
MICRA	646
MURANO	647
NOTE	648
NV-2500	650
NV-3500	650
NX	650
PATHFINDER	651
PLATINA	653
PICK UP	655
QUEST	655
ROGUE	658
SAKURA	660
SAMURAY	660
SEDAN	661
SENTRA	662
STANZA	669
TIIDA	670

CONTINUACIÓN...

NISSAN

TITAN	672
TSUBAME	673
TSURU I	676
TSURU II	679
TSURU III	682
URVAN	687
VAGONETA	689
VARIOS	689
VERSA	690
X-TERRA	692
X-TRAIL	693

OLDSMOBILE

ACHIEVA	697
ALERO	698
AURORA	699
BRAVADA	700
CUTLASS CALAIS	701
CUTLASS CIERA	702
CUTLASS SUPREME	702
DELTA 88 ROYALE	703
FIRENZA	704
INTRIGUE	705
LSS	705
OMEGA	706
SILHOUETTE	707
TORNADO	709

OPEL

RECKORD OLIMPIA	709
-----------------------	-----

PEUGEOT

206	711
207	712
306	714
307	714
308	715
405	715
406	716
407	716
605	716
607	717
3008	717
FELINE	717
GRAND RAID	718
PARTNER	718

PLYMOUTH

BREEZE	720
CARAVELLE	721

PONTIAC

6000	723
AZTEK	723
BONNEVILLE	724
FIREBIRD	725
FIREFLY CANADIAN	728
G3	728
G4	730
G5	730
G6	731
GRAND AM	732
GRAND PRIX	736
MONTANA	739
PHOENIX	740
PURSUIT	740
SUNBIRD	741
SUNFIRE	741
TEMPEST	743
TORRENT	744
TRANS AM	745
TRANS SPORT	746
VIBE	747
WAVE	748

RAMBLER

VARIOS	749
--------------	-----

RENAULT

ALLIANCE	749
CLIO	750
DUSTER	752
ENCORE	753
KANGOO	753
KOLEOS	755
LAGUNA	756
MEGANE I	757
MEGANE II	757
R5	758
R8	759
R9	759
R10	760
R12	760
R18	761
SAFRANE	762
SANDERO	762
SCALA	763
SCENIC I	765
SCENIC II	766
STEPWAY	767
TL	768
TRAFIC	768
TS	769
VARIOS	769

SAAB

9-3	771
9-7X	771

SATURN

AURA	772
ION	772
ION 1	773
ION 2	773
ION 3	774
OUTLOOK	774
RELAY	775
VUE	775

SEAT

ALHAMBRA	777
ALTEA	778
CORDOBA	779
IBIZA	781
LEON	785
TOLEDO	789

SUZUKI

AERIO	793
EQUATOR	793
GRAND VITARA	794
KIZASHI	794
SIDEKICK	794
SX-4	795
SWIFT	796
VARIOS	797
VITARA	797
X-90	797
XL-7	798

TOYOTA

4 RUNNER	799
AUTOS	800
AVANZA	800
AVALON	801
BJ-40	802
BJ-70	802
CAMIONETAS	802
CAMRY	803
CELICA	806
COASTER	806
COROLLA	806
CORONA	808
CROW	808
ECHO	808
FJ CRUSIER	809
HIACE	809
HIGHLANDER	809
HILUX	811
HJ-45	812
LAND CRUSIER	812
LN-65	813

CONTINUACIÓN...

TOYOTA

MATRIX.....	813
PICK UP.....	814
PICK UP 22-R.....	815
PRIUS-C.....	816
RAV-4.....	816
SCION-XD.....	818
SIENNA.....	818
SOLARA.....	820
T-100.....	821
TACOMA.....	822
TERCEL.....	823
VARIOS.....	824
VENZA.....	824
YARIS.....	824

UNIVERSAL

VARIOS.....	827
-------------	-----

VAM

AMERICAN.....	831
CLASSIC.....	831
CONCORD.....	832
GRAND WAGONER.....	832
GREMLIN.....	832
J 4WD.....	833
JAVELIN.....	833
RAMBLER.....	834

VOLKSWAGEN

ATLANTIC.....	837
BEETLE.....	839
BORA.....	842
BRASILIA.....	844
CABRIOLET.....	844
CARIBE.....	845
COMBI.....	847
CORRADO.....	848
CORSAR.....	849
CROSS FOX.....	850
DASHER.....	852
DERBI.....	852
EUROVAN.....	855
GOL.....	857
GOLF.....	860
GOLF A2.....	861
GOLF A3.....	863
GOLF A4.....	866
GOLF A5.....	869
GOLF A6.....	870
GOLF GTI.....	870
GOLF VR6.....	870
JETTA.....	871
JETTA BICENTENARIO.....	872
JETTA A2.....	874

CONTINUACIÓN...

VOLKSWAGEN

JETTA A3.....	877
JETTA A4.....	879
JETTA A5.....	882
JETTA A6.....	883
JETTA VR6.....	884
LUPO.....	885
PANEL.....	886
PASSAT.....	888
PASSAT CC.....	891
POINTER.....	892
POINTER PICK UP.....	894
POLO.....	895
POLO SEDAN.....	897
RABBIT.....	898
ROUTAN.....	899
SAFARI.....	900
SAVEIRO.....	901
SCIROCCO.....	903
SEDAN.....	904
SHARAN.....	906
SPORT VAN.....	907
TIGUAN.....	909
TRANSPORTER.....	910
VARIOS.....	910
VENTO.....	911

VOLVO

C-30.....	913
S-40.....	913
S-60.....	914
S-70.....	915
S-80.....	915
V-50.....	915
V-70.....	916
XC-70.....	916
XC-90.....	916

**GOMAS Y SOPORTES
CARDÁN**
BMW

318i, 318is, 318it.....	917
323is, 325i, 325is, 328i, 328is.....	917
525i, 528i, 530i.....	917
Z3.....	918

CHEVROLET

AVALANCHE.....	918
BLAZER.....	918

CONTINUACIÓN...

CHEVROLET

CANYON.....	925
CHEYENNE.....	926
COLORADO.....	926
DENALI.....	926
JIMMY.....	927
S10.....	928
S15.....	928
SIERRA.....	929
SILVERADO.....	930
SONORA.....	930
SUBURBAN.....	931
TAHOE.....	932
YUKON.....	932
C-15.....	920
C-20.....	921
C-1500.....	921
C-2500.....	922
C-3500.....	923
C-4500.....	924

DODGE / CHRYSLER

D-150.....	934
D-200.....	935
D-250.....	936
D-300.....	938
D-350.....	939
DAKOTA.....	940
DURANGO.....	941
RAM 1500.....	942
RAM 2500.....	943
RAM CHARGER.....	943

FORD

D-150.....	934
D-200.....	935
D-250.....	936
D-300.....	938
D-350.....	939
DAKOTA.....	940
DURANGO.....	941
RAM 1500.....	942
RAM 2500.....	943
RAM CHARGER.....	943

LEXUS

ES-350.....	956
-------------	-----

MERCEDES BENZ

SPRINTER.....	962
---------------	-----



CONTINUACION... NISSAN

D-21.....	962
PICK UP.....	963

OTROS

MEDIDAS DE GOMAS Y SOPORTES PARA CARDÁN... _	965
ILUSTRACIONES (CONSECUTIVO).....	967
INTERCAMBIOS SOPORTES... _	1043
INTERCAMBIOS BASES PARA AMORTIGUADOR.....	1051
MEDIDAS DE BUJES DE REPUESTO.....	1056
MEDIDAS DE CUBRE POLVOS Y TRIPOIDES.....	1071
NÚMEROS NUEVOS.....	1079

DAI le ofrece este catálogo como ayuda al manejo de su línea de productos, la información de su contenido ha sido organizada por marca, modelo del automóvil y sublínea de Producto DAI.

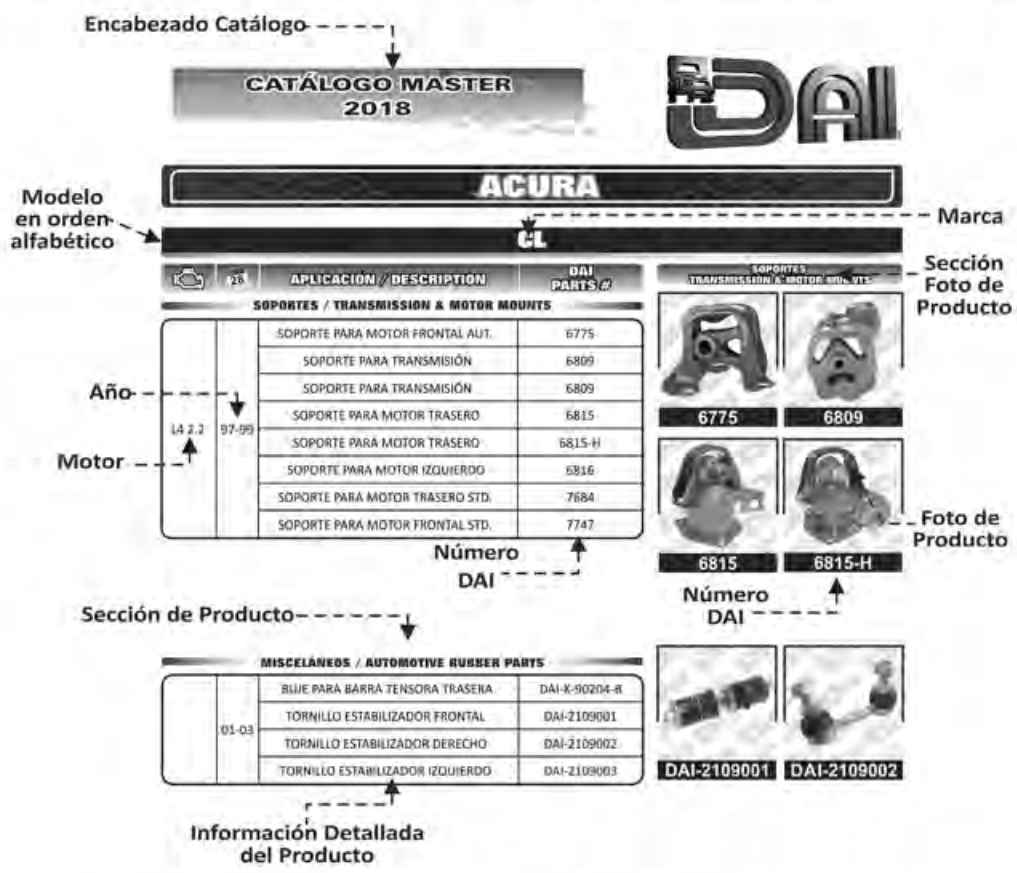



*En la sección de ilustraciones podrá identificar el consecutivo de Números DAI, el cual muestra la foto, aplicación general y paginación del producto.





ACURA

CL

  28		APLICACIÓN / DESCRIPTION	DAI PARTS #
SOPORTES / TRANSMISSION & MOTOR MOUNTS			
L4 2.2	97-99	SOPORTE PARA MOTOR FRONTAL AUT.	6775
		SOPORTE PARA TRANSMISIÓN	6809
		SOPORTE PARA TRANSMISIÓN	6809
		SOPORTE PARA MOTOR TRASERO	6815
		SOPORTE PARA MOTOR TRASERO	6815-H
		SOPORTE PARA MOTOR IZQUIERDO	6816
		SOPORTE PARA MOTOR TRASERO STD.	7684
		SOPORTE PARA MOTOR FRONTAL STD.	7747
L4 2.3	97-99	SOPORTE PARA MOTOR FRONTAL AUT.	6775
		SOPORTE PARA TRANSMISIÓN	6809
		SOPORTE PARA MOTOR TRASERO	6815
		SOPORTE PARA MOTOR TRASERO	6815-H
		SOPORTE PARA MOTOR IZQUIERDO	6816
		SOPORTE PARA MOTOR TRASERO STD.	7684
		SOPORTE PARA MOTOR FRONTAL STD.	7747
		V6 3.2	01-03
SOPORTE PARA TRANSMISIÓN FRONTAL	7052		
SOPORTE PARA TRANSMISIÓN TRASERO	7053		
SOPORTE PARA TRANSMISIÓN TRASERO	7165		
SOPORTE PARA MOTOR TRASERO	7503-H		
SOPORTE PARA MOTOR FRONTAL	7709-H		



CONTINUACIÓN... CL

 		APLICACIÓN / DESCRIPTION	DAI PARTS #
MISCELÁNEOS / AUTOMOTIVE RUBBER PARTS			
01-03		BUJE PARA BARRA TENSORA TRASERA	DAI-K-90204-B
		TORNILLO ESTABILIZADOR FRONTAL	DAI-2109001
		TORNILLO ESTABILIZADOR DERECHO	DAI-2109002
		TORNILLO ESTABILIZADOR IZQUIERDO	DAI-2109003



CSX

SOPORTES / TRANSMISSION & MOTOR MOUNTS			
L4 2.0	06-11	SOPORTE PARA MOTOR FRONTAL	7523
		SOPORTE PARA MOTOR DERECHO INFERIOR	7657-H
		SOPORTE PARA MOTOR DERECHO SUPERIOR TORQUE STRUT	7746
		SOPORTE PARA MOTOR TRASERO TORQUE STRUT	7792

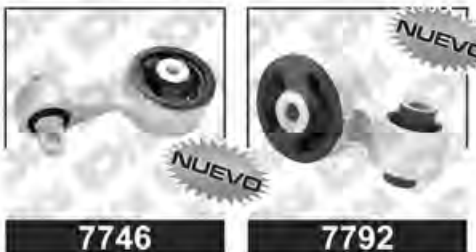

EL

		 28	APLICACIÓN / DESCRIPTION	DAI PARTS #
SOPORTES / TRANSMISSION & MOTOR MOUNTS				
L4 1.7	01-02	SOPORTE PARA TRANSMISIÓN AUT. CVT		7044
	01-04	SOPORTE PARA TRANSMISIÓN STD.		
	01-05	SOPORTE PARA MOTOR FRONTAL AUT.		7043
	01-05	SOPORTE PARA MOTOR FRONTAL STD.		7046
		SOPORTE PARA MOTOR TRASERO		7047
	02-04	SOPORTE PARA MOTOR IZQUIERDO		7048-H



IL-X

SOPORTES / TRANSMISSION & MOTOR MOUNTS				
L4 1.7	16-17	SOPORTE PARA MOTOR TRASERO		7413



MISCELÁNEOS / AUTOMOTIVE RUBBER PARTS				
	13-14	TORNILLO ESTABILIZADOR TRASERO DERECHO		DAI-2109028
		TORNILLO ESTABILIZADOR TRASERO IZQUIERDO		DAI-2109029



INTEGRA

		APLICACIÓN / DESCRIPTION	DAI PARTS #
SOPORTES / TRANSMISSION & MOTOR MOUNTS			
L4 1.8	94-01	SOPORTE PARA MOTOR TRASERO	6810
		SOPORTE PARA MOTOR FRONTAL	6818
		SOPORTE PARA MOTOR FRONTAL IZQUIERDO	6819

MDX

SOPORTES / TRANSMISSION & MOTOR MOUNTS			
L4 2.4	03-08	SOPORTE PARA TRANSMISIÓN AUT. FRONTAL INFERIOR	7193
		SOPORTE PARA TRANSMISIÓN AUT. TRASERO INFERIOR	7202
		SOPORTE PARA MOTOR DERECHO	7205-H
		SOPORTE PARA MOTOR TRASERO	7207-H
		SOPORTE PARA TRANSMISIÓN SUPERIOR	7248
	07-13	SOPORTE PARA MOTOR FRONTAL Y TRASERO	7206-H
V6 3.5	01-02	SOPORTE PARA TRANSMISIÓN TRASERO	7053
		SOPORTE PARA TRANSMISIÓN TRASERO	7165



CONTINUACIÓN... MDX

  28		APLICACIÓN / DESCRIPTION	DAI PARTS #
SOPORTES / TRANSMISSION & MOTOR MOUNTS			
V6 3.5	01-06	SOPORTE PARA TRANSMISIÓN FRONTAL	7052
		SOPORTE PARA MOTOR FRONTAL	7364-H
		SOPORTE PARA MOTOR TRASERO	7724
	03-06	SOPORTE PARA MOTOR DERECHO	7050
		SOPORTE PARA TRANSMISIÓN AUT. FRONTAL INFERIOR	7193
	03-06	SOPORTE PARA TRANSMISIÓN AUT. TRASERO INFERIOR	7202
01-13	SOPORTE PARA MOTOR DERECHO	7389	



MISCELÁNEOS / AUTOMOTIVE RUBBER PARTS		
01-06	BUJE PARA HORQUILLA INFERIOR GRANDE	DAI-1409005
	BUJE PARA HORQUILLA INFERIOR CHICO	DAI-1409006



RDX

 28		APLICACIÓN / DESCRIPTION	DAI PARTS #
SOPORTES / TRANSMISSION & MOTOR MOUNTS			
L4 2.3	07-12	SOPORTE PARA MOTOR TRASERO	7223
		SOPORTE PARA MOTOR DERECHO	7653-H
V6 3.5	13-15	SOPORTE PARA MOTOR FRONTAL	7519-EL

**SOPORTES
TRANSMISSION & MOTOR MOUNTS**



7223



7519-EL



NUEVO

7653-H

MISCELÁNEOS / AUTOMOTIVE RUBBER PARTS			
	07-12	TORNILLO ESTABILIZADOR FRONTAL IZQUIERDO Y DERECHO	DAI-2109023

**MISCELÁNEOS
AUTOMOTIVE RUBBER PARTS**



NUEVO

DAI-2109023

RSX

SOPORTES / TRANSMISSION & MOTOR MOUNTS			
L4 2.0	02-06	SOPORTE PARA TRANSMISIÓN	7100
		REPUESTO PARA SOPORTE DE TRANSMISIÓN (7100)	7100-9

**SOPORTES
TRANSMISSION & MOTOR MOUNTS**



7100



NUEVO

7100-9



CONTINUACIÓN... RSX

 28		APLICACIÓN / DESCRIPTION	DAI PARTS #
SOPORTES / TRANSMISSION & MOTOR MOUNTS			
L4 2.0	02-06	SOPORTE PARA MOTOR FRONTAL	7101
		SOPORTE PARA MOTOR TRASERO	7102
		SOPORTE PARA MOTOR FRONTAL	7523
		SOPORTE PARA MOTOR DERECHO	7633-H



SLX

SOPORTES / TRANSMISSION & MOTOR MOUNTS			
V6 3.2	96-97	SOPORTE PARA MOTOR IZQUIERDO	7686
V6 3.5	96-99	SOPORTE PARA MOTOR IZQUIERDO	7686





TL

SOPORTES / TRANSMISSION & MOTOR MOUNTS			
V6 3.2	96-98	SOPORTE PARA MOTOR DERECHO	7050
	99-03	SOPORTE PARA TRANSMISIÓN FRONTAL	7052



CONTINUACIÓN... TL

  28		APLICACIÓN / DESCRIPTION	DAI PARTS #
SOPORTES / TRANSMISSION & MOTOR MOUNTS			
V6 3.2	99-03	SOPORTE PARA TRANSMISIÓN TRASERO	7053
		SOPORTE PARA TRANSMISIÓN TRASERO	7165
		SOPORTE PARA MOTOR TRASERO	7503-H
	04-06	SOPORTE PARA TRANSMISIÓN	7508
	04-08	SOPORTE PARA TRANSMISIÓN FRONTAL	7590
V6 3.5	06-08	SOPORTE PARA MOTOR DERECHO	7205-H
		SOPORTE PARA MOTOR FRONTAL	7206-H
		SOPORTE PARA MOTOR TRASERO	7207-H
		SOPORTE PARA TRANSMISIÓN	7508
		SOPORTE PARA TRANSMISIÓN FRONTAL	7590
	09-14	SOPORTE PARA TRANSMISIÓN SUPERIOR AUT.	7398-H
		SOPORTE PARA MOTOR DERECHO	7501-H
V6 3.7	09-14	SOPORTE PARA MOTOR DERECHO	7501-H
		SOPORTE PARA TRANSMISIÓN SUPERIOR AUT.	7398-H
		SOPORTE PARA TRANSMISIÓN SUPERIOR STD. Y AUT. (SIN ALUMINIO)	7398-H-9

SOPORTES TRANSMISSION & MOTOR MOUNTS



7050

7052



7053

7165



7205-H



7207-H

7398-H

7398-H-9

7501-H

7503-H

7508



7590



CONTINUACIÓN... TL

28		APLICACIÓN / DESCRIPTION	DAI PARTS #	DAI KIT PARTS #
BASES PARA AMORTIGUADOR / STRUT MOUNTS				
04-12		BASE PARA AMORTIGUADOR FRONTAL IZQUIERDA Y DERECHA		6736-KIT
		BASE PARA AMORTIGUADOR FRONTAL IZQUIERDA Y DERECHA	6755	



28		APLICACIÓN / DESCRIPTION	DAI PARTS #
MISCELÁNEOS / AUTOMOTIVE RUBBER PARTS			
99-03		TORNILLO ESTABILIZADOR FRONTAL	DAI-2109001
		TORNILLO ESTABILIZADOR DERECHO	DAI-2109002
		TORNILLO ESTABILIZADOR IZQUIERDO	DAI-2109003
01-03		BUJES PARA BARRA TENSORA TRASERA	DAI-K-90204-B
04-08		TORNILLO ESTABILIZADOR FRONTAL IZQUIERDO	DAI-2109013



TLX

SOPORTES / TRANSMISSION & MOTOR MOUNTS			
L4 2.4	15-17	SOPORTE PARA MOTOR TRASERO STD.	7680
		SOPORTE PARA MOTOR FRONTAL	7679-H



CONTINUACIÓN... TLX

 		APLICACIÓN / DESCRIPTION	DAI PARTS #
SOPORTES / TRANSMISSION & MOTOR MOUNTS			
L4 2.4	2015	SOPORTE PARA MOTOR DERECHO	7789-H
V6 3.2	99-03	SOPORTE PARA MOTOR FRONTAL	7709-H



TSX

SOPORTES / TRANSMISSION & MOTOR MOUNTS			
L4 2.4	04-08	SOPORTE PARA TRANSMISIÓN AUT. FRONTAL INFERIOR	7193
		SOPORTE PARA TRANSMISIÓN AUT. TRASERO INFERIOR	7202
		SOPORTE PARA MOTOR DERECHO	7205-H
		SOPORTE PARA MOTOR FRONTAL	7206-H
		SOPORTE PARA MOTOR TRASERO	7207-H
		SOPORTE PARA TRANSMISIÓN SUPERIOR	7248
		SOPORTE PARA TRANSMISIÓN FRONTAL INFERIOR	7677
	09-10	SOPORTE PARA MOTOR DERECHO	7501-H
	09-14	SOPORTE PARA MOTOR TRASERO	7349
		SOPORTE PARA TRANSMISIÓN FRONTAL INFERIOR	7396





CONTINUACIÓN... TSX

		APLICACIÓN / DESCRIPTION	DAI PARTS #
SOPORTES / TRANSMISSION & MOTOR MOUNTS			
L4 2.4	09-14	SOPORTE PARA TRANSMISIÓN AUT. SUPERIOR	7398-H
		SOPORTE PARA TRANSMISION SUPERIOR STD. Y AUT. (SIN ALUMINIO)	7398-H-9
	2015	SOPORTE PARA MOTOR DERECHO	7789-H
V6 3.5	10-12	SOPORTE PARA TRANSMISIÓN FRONTAL INFERIOR	7557



	APLICACIÓN / DESCRIPTION	DAI PARTS #	DAI KIT PARTS #
BASES PARA AMORTIGUADOR / STRUT MOUNTS			
04-12	BASE PARA AMORTIGUADOR FRONTAL IZQUIERDA Y DERECHA		6736-KIT
	BASE PARA AMORTIGUADOR FRONTAL IZQUIERDA Y DERECHA	6755	



		APLICACIÓN / DESCRIPTION	DAI PARTS #
MISCELÁNEOS / AUTOMOTIVE RUBBER PARTS			
	04-08	BUJE PARA HORQUILLA INFERIOR GRANDE	DAI-1409012
		TORNILLO ESTABILIZADOR FRONTAL IZQUIERDO	DAI-2109013





**CATÁLOGO MASTER
2018**



IMPORTANTE: Identifica nuestro producto con el grabado del logo  No aceptes imitaciones.



AUDI

A1

 		APLICACIÓN / DESCRIPTION	DAI PARTS #
SOPORTES / TRANSMISSION & MOTOR MOUNTS			
L4 2.4	11-17	SOPORTE PARA MOTOR DERECHO	7057-H
		SOPORTE PARA MOTOR TRASERO TORQUE STRUT	7058
		SOPORTE PARA TRANSMISIÓN	7060

**SOPORTES
TRANSMISSION & MOTOR MOUNTS**



7057-H



7058



7060

		APLICACIÓN / DESCRIPTION	DAI PARTS #	DAI KIT PARTS #
BASES PARA AMORTIGUADOR / STRUT MOUNTS				
11-17		BASE PARA AMORTIGUADOR FRONTAL IZQUIERDA Y DERECHA	1815	1815-KIT
		BASE PARA AMORTIGUADOR TRASERA IZQUIERDA Y DERECHA	6906	
		BALERO PARA BASE DE AMORTIGUADOR (1815 Y 6759)	6119	

**BASES PARA AMORTIGUADOR
STRUT MOUNTS**



1815



1815-KIT



6906



6119

 		APLICACIÓN / DESCRIPTION	DAI PARTS #
MISCELÁNEOS / AUTOMOTIVE RUBBER PARTS			
	04-11	BUJES PARA HORQUILLA INFERIOR POLIURETANO KIT CON CASQUILLO	9809
	11-13	BUJE PARA HORQUILLA INFERIOR GRANDE CON CEJA (BUJE INTERIOR CHICO)	64650

**MISCELÁNEOS
AUTOMOTIVE RUBBER PARTS**



9809



64650



CONTINUACIÓN... A1

		APLICACIÓN / DESCRIPTION	DAI PARTS #
SOPORTES / TRANSMISSION & MOTOR MOUNTS			
11-13	TORNILLO ESTABILIZADOR FRONTAL		DAI-2126004
	BUJE PARA HORQUILLA CHICO		DAI-191-407-182

DAI-2126004 | DAI-191-407-182
A3

SOPORTES / TRANSMISSION & MOTOR MOUNTS				
L4 1.4	06-14	SOPORTE PARA MOTOR TRASERO SUPERIOR (CON CUERDA)	7194	
		SOPORTE PARA MOTOR TRASERO INFERIOR (SIN CUERDA)	7195	
		SOPORTE PARA TRANSMISIÓN	7211	
		SOPORTE PARA TRANSMISIÓN AUT. Y STD.	7212	
		SOPORTE PARA MOTOR TRASERO TORQUE STRUT	7254	
08-13	SOPORTE PARA MOTOR DERECHO		7654-H	
L4 1.8	97-01	SOPORTE PARA MOTOR DERECHO	6976-H	
		SOPORTE PARA MOTOR TRASERO	6978	
	04-13	SOPORTE PARA MOTOR DERECHO		7654-H
	06-14	SOPORTE PARA MOTOR TRASERO SUPERIOR (CON CUERDA)		7194
		SOPORTE PARA MOTOR TRASERO INFERIOR (SIN CUERDA)		7195
		SOPORTE PARA TRANSMISIÓN		7211
		SOPORTE PARA TRANSMISIÓN AUT. Y STD.		7212
		SOPORTE PARA MOTOR TRASERO TORQUE STRUT		7254
	L4 2.0	06-11	SOPORTE PARA MOTOR TRASERO SUPERIOR (CON CUERDA)	7194
		10-13	SOPORTE PARA MOTOR TRASERO SUPERIOR (CON CUERDA) <i>TDI</i>	
06-11		SOPORTE PARA TRANSMISIÓN AUT.		7211
	SOPORTE PARA MOTOR TRASERO		7254	

6976-H
6978

7194
7195

7211
7212

7254
7654-H

CONTINUACIÓN... A3

 		APLICACIÓN / DESCRIPTION	DAI PARTS #
SOPORTES / TRANSMISSION & MOTOR MOUNTS			
L4 2.0	97-01	SOPORTE PARA MOTOR DERECHO	6976-H
		SOPORTE PARA TRANSMISIÓN AUT.	6977
		SOPORTE PARA MOTOR TRASERO	6978
	06-11	SOPORTE PARA MOTOR TRASERO INFERIOR (SIN CUERDA)	7195
	10-13	SOPORTE PARA MOTOR TRASERO INFERIOR (SIN CUERDA) <i>TDI</i>	
	06-13	SOPORTE PARA MOTOR DERECHO	7654-H
	06-14	SOPORTE PARA TRANSMISIÓN STD.	7212
	10-13	SOPORTE PARA TRANSMISIÓN STD. SUPERIOR (CON CUERDA) <i>TDI</i>	



		APLICACIÓN / DESCRIPTION	DAI PARTS #	DAI KIT PARTS #
BASES PARA AMORTIGUADOR / STRUT MOUNTS				
98-03		BASE PARA AMORTIGUADOR FRONTAL IZQUIERDA Y DERECHA	1815	1815-KIT
		BASE PARA AMORTIGUADOR FRONTAL IZQUIERDA Y DERECHA	6759	6759-KIT
04-12		BALERO PARA BASE DE AMORTIGUADOR FRONTAL IZQ. Y DER.	6145	



CONTINUACIÓN... A3



28		APLICACIÓN / DESCRIPTION	DAI PARTS #	DAI KIT PARTS #
BASES PARA AMORTIGUADOR / STRUT MOUNTS				
98-03	BASE PARA AMORTIGUADOR FRONTAL IZQUIERDA Y DERECHA		1816	
	BALERO PARA BASE DE AMORTIGUADOR (1815)		6119	



28		APLICACIÓN / DESCRIPTION	DAI PARTS #
MISCELÁNEOS / AUTOMOTIVE RUBBER PARTS			
98-03	TOPE PARA AMORTIGUADOR FRONTAL IZQUIERDO Y DERECHO		D-074
	BUJES PARA HORQUILLA INFERIOR POLIURETANO KIT		9800
	BUJES PARA HORQUILLA INFERIOR POLIURETANO KIT CON CASQUILLO		9809
	BUJE PARA HORQUILLA INFERIOR GRANDE CON CEJA BUJE INTERNO CHICO		64650
	BUJE PARA HORQUILLA INFERIOR GRANDE CON CEJA BUJE INTERNO GRANDE		64651
	BUJE PARA HORQUILLA INFERIOR GRANDE (SIN CEJA BUJE INTERNO GRANDE)		64760
	BUJE PARA EJE TRASERO IZQ. Y DER.		DAI-1426037
	TORNILLO ESTABILIZADOR FRONTAL DER.		DAI-2126002
	BUJE PARA EJE TRASERO IZQ. Y DER.		DAI-1J0-501-541
	BUJE PARA HORQUILLA CHICO		DAI-191-407-182
04-10	BUJE PARA HORQUILLA INFERIOR CHICO		DAI-1426011



CONTINUACIÓN... A3

	 28	APLICACIÓN / DESCRIPTION	DAI PARTS #
MISCELÁNEOS / AUTOMOTIVE RUBBER PARTS			
	04-15	TORNILLO ESTABILIZADOR FRONTAL	DAI-2126010
	06-08	GOMA SUJETADORA DE ESCAPE	6569
	13-15	BUJE PARA HORQUILLA INFERIOR GRANDE	DAI-1426023

**MISCELÁNEOS
AUTOMOTIVE RUBBER PARTS**



6569



DAI-1426023



DAI-2126010

A3 QUATTRO

SOPORTES / TRANSMISSION & MOTOR MOUNTS			
L4 2.0	06-13	SOPORTE PARA MOTOR DERECHO	7654-H
	09-13	SOPORTE PARA TRANSMISIÓN	7211
		SOPORTE PARA MOTOR TRASERO TORQUE STRUT	7254
V6 3.2	06-07	SOPORTE PARA TRANSMISIÓN	7211
		SOPORTE PARA MOTOR TRASERO TORQUE STRUT	7254

**SOPORTES
TRANSMISSION & MOTOR MOUNTS**



7211



7254



7654-H



A4

28		APLICACIÓN / DESCRIPTION	DAI PARTS #
SOPORTES / TRANSMISSION & MOTOR MOUNTS			
L4 1.6	01-04	SOPORTE PARA TRANSMISIÓN	7611
L4 2.0	01-08		
L4 1.8T	01-09		
L4 1.9TDI	01-08		
L4 2.0TFSI			
L4 2.5TDI	01-05		
V6 2.4			
V6 3.0			
L4 1.8	97-01	SOPORTE PARA MOTOR IZQUIERDO	7452-H
L4 2.0	05-07		
V6 2.8	96-01		
L4 1.8	97-05	SOPORTE PARA TRANSMISIÓN IZQ. Y DER., STD.	7581
V6 2.8	96-01		
L4 1.8	97-01	SOPORTE PARA TRANSMISIÓN IZQ. Y DER. AUT.	7582
V6 2.8	96-01		
V6 3.0	03-08		
L4 1.8T	01-09	SOPORTE TRASERO DIFERENCIAL	7610
L4 1.9TDI	01-04		
L4 2.0TDI	06-08		
L4 2.0TFSI	04-08		
V6 2.5TDI	00-04		
V6 3.0	00-06		
V6 3.0TDI	04-09		
V6 3.2FSI	05-09		

**SOPORTES
TRANSMISSION & MOTOR MOUNTS**

7452-H

7581

7582

7610

7611

CONTINUACIÓN... A4

	APLICACIÓN / DESCRIPTION	DAI PARTS #	DAI KIT PARTS #
BASES PARA AMORTIGUADOR / STRUT MOUNTS			
91-06	BASE PARA AMORTIGUADOR TRASERA IZQUIERDA Y DERECHA	6739	6739-KIT
98-01	BASE PARA AMORTIGUADOR FRONTAL IZQUIERDA Y DERECHA	7035	



		APLICACIÓN / DESCRIPTION	DAI PARTS #
MISCELÁNEOS / AUTOMOTIVE RUBBER PARTS			
	98-07	BUJE DE HORQUILLA SUPERIOR	DAI-1426020



A4 QUATTRO

SOPORTES / TRANSMISSION & MOTOR MOUNTS			
L4 1.8	97-05	SOPORTE PARA MOTOR DERECHO	7452-H
	07-14	SOPORTE PARA MOTOR IZQUIERDO	
L4 2.0	05-08	SOPORTE PARA MOTOR IZQUIERDO Y DERECHO	
V6 2.8	96-04		
	07-14		
V6 3.0	96-04		
	07-14		



CONTINUACIÓN... A4 QUATTRO

28		APLICACIÓN / DESCRIPTION	DAI PARTS #	SOPORTES TRANSMISION & MOTOR MOUNTS	
SOPORTES / TRANSMISION & MOTOR MOUNTS					
L4 1.8T	01-09	SOPORTE TRASERO PARA DIFERENCIAL	7610		
L4 1.9TDI	01-04			7452-H	7581
L4 2.0TDI	06-08				
L4 2.0TFSI	04-08			7582	7610
V6 2.5TDI	00-04				
V6 3.0	00-06			7611	7654-H
V6 3.0TDI	04-09				
V6 3.2FSI	05-09			7611	7654-H
L4 1.8T	01-09	SOPORTE PARA TRANSMISIÓN	7611		
L4 1.9TDI	01-04			7582	7610
L4 2.0TFSI	04-08				
L4 2.5TDI	01-04			7611	7654-H
V6 3.0	01-05				
L4 1.8	07-14	SOPORTE PARA TRANSMISIÓN STD. IZQUIERDO Y DERECHO	7581		
V6 2.8	96-01			7611	7654-H
L4 1.8	07-14	SOPORTE PARA TRANSMISIÓN AUT. IZQUIERDO Y DERECHO	7582		
V6 2.8				7611	7654-H
V6 3.0					
L4 2.0	09-13	SOPORTE PARA MOTOR DERECHO	7654-H		

A6

SOPORTES / TRANSMISION & MOTOR MOUNTS				SOPORTES TRANSMISION & MOTOR MOUNTS	
V6 2.8	98-01	SOPORTE PARA MOTOR IZQUIERDO Y DERECHO	7452-H		
V6 3.0	00-04			7452-H	



A6

  28		APLICACIÓN / DESCRIPTION	DAI PARTS #
SOPORTES / TRANSMISSION & MOTOR MOUNTS			
V6 2.8	98-99	SOPORTE PARA TRANSMISIÓN AUT. IZQUIERDO Y DERECHO	7582
V6 3.0	00-04		
L4 2.0TDI	04-11	SOPORTE PARA TRANSMISIÓN	7609
L4 2.0TFSI	05-11		
V6 2.4	04-08		
V6 2.8	07-08		
V6 2.8FSI	06-08		
V6 3.0	04-11		
V6 3.2FSI	04-08		
V6 2.4	05-08	SOPORTE TRASERO PARA DIFERENCIAL	7610
V6 2.7TDI	04-11		
V6 2.8FSI	07-11		
V6 3.0	01-04		
V6 3.0TDI	04-11		
V6 3.0TFSI	08-11		
V6 3.2FSI	04-08		
V8 4.2	04-11		
V8 4.2FSI	06-11		

**SOPORTES
TRANSMISSION & MOTOR MOUNTS**



7582



7609



7610

 28		APLICACIÓN / DESCRIPTION	DAI PARTS #	DAI KIT PARTS #
BASES PARA AMORTIGUADOR / STRUT MOUNTS				
98-01		BASE PARA AMORTIGUADOR FRONTAL IZQUIERDA Y DERECHA	7035	

**BASES PARA AMORTIGUADOR
STRUT MOUNTS**



7035



CONTINUACIÓN... A6

	28	APLICACIÓN / DESCRIPTION	DAI PARTS #
MISCELÁNEOS / AUTOMOTIVE RUBBER PARTS			
	98-11	BUJE DE HORQUILLA SUPERIOR	DAI-1426020

A6 QUATTRO

SOPORTES / TRANSMISSION & MOTOR MOUNTS			
V6 2.4	05-08	SOPORTE PARA TRANSMISIÓN	7609
V6 3.0	04-11		
V6 3.2FSI	04-08		
V8 4.2FSI	04-11		
V8 4.2	04-11		
V6 2.4	05-08	SOPORTE TRASERO PARA DIFERENCIAL	7610
V6 2.7TDI	04-11		
V6 2.8FSI	07-11		
V6 3.0	01-04		
V6 3.0TDI	04-11		
V6 3.0TFSI	08-11		
V6 3.2FSI	04-08		
V8 4.2FSI	06-11		
V8 4.2	04-11		
V6 2.7	00-04	SOPORTE PARA MOTOR IZQUIERDO	7452-H
V6 2.8	98-99	SOPORTE PARA TRANSMISIÓN AUT. IZQUIERDO Y DERECHO	7582



ALLROAD QUATTRO

28		APLICACIÓN / DESCRIPTION	DAI PARTS #
SOPORTES / TRANSMISSION & MOTOR MOUNTS			
V6 2.7	01-05	SOPORTE PARA MOTOR IZQUIERDO	7452-H

**SOPORTES
TRANSMISSION & MOTOR MOUNTS**



7452-H

Q3

SOPORTES / TRANSMISSION & MOTOR MOUNTS			
L4 2.0	11-15	SOPORTE PARA MOTOR TRASERO SUPERIOR CON CUERDA	7194
		SOPORTE PARA MOTOR TRASERO SUPERIOR SIN CUERDA	7195
		SOPORTE PARA MOTOR DERECHO	7453-H
	11-17	SOPORTE PARA TRANSMISIÓN	7211
	15-17	SOPORTE PARA MOTOR TRASERO	7254

**SOPORTES
TRANSMISSION & MOTOR MOUNTS**



7194



7195



7211



7254



7453-H

MISCELÁNEOS / AUTOMOTIVE RUBBER PARTS			
	11-15	BUJE PARA HORQUILLA INFERIOR CHICO	DAI-1426011
		TORNILLO ESTABILIZADOR FRONTAL	DAI-2126010

**MISCELÁNEOS
AUTOMOTIVE RUBBER PARTS**



DAI-1426011



DAI-2126010



RS4

			APLICACIÓN / DESCRIPTION	DAI PARTS #
SOPORTES / TRANSMISSION & MOTOR MOUNTS				
V8 4.2	2008	SOPORTE TRASERO PARA DIFERENCIAL		7610

**SOPORTES
TRANSMISSION & MOTOR MOUNTS**

7610
RS6

SOPORTES / TRANSMISSION & MOTOR MOUNTS				
V10 5.2	08-11	SOPORTE PARA TRANSMISIÓN		7609

**SOPORTES
TRANSMISSION & MOTOR MOUNTS**

7609
S4

SOPORTES / TRANSMISSION & MOTOR MOUNTS				
V6 2.7	00-02	SOPORTE PARA MOTOR IZQUIERDO		7452-H
	00-04	SOPORTE PARA TRANSMISIÓN AUT. IZQ. Y DER.		7582
V8 4.2	03-09	SOPORTE TRASERO PARA DIFERENCIAL		7610

**SOPORTES
TRANSMISSION & MOTOR MOUNTS**

7452-H

7582

7610

S6

  28		APLICACIÓN / DESCRIPTION	DAI PARTS #
SOPORTES / TRANSMISSION & MOTOR MOUNTS			
V10 5.2	06-11	SOPORTE PARA TRANSMISIÓN	7609

**SOPORTES
TRANSMISSION & MOTOR MOUNTS**



7609

TT

SOPORTES / TRANSMISSION & MOTOR MOUNTS			
L4 1.8	07-13	SOPORTE PARA MOTOR DERECHO	7654-H
L4 2.0	08-09		
L4 2.0	08-09	SOPORTE PARA TRANSMISIÓN	7211
		SOPORTE PARA MOTOR TRASERO TORQUE STRUT	7254

**SOPORTES
TRANSMISSION & MOTOR MOUNTS**



7211



7254



7654-H

 28		APLICACIÓN / DESCRIPTION	DAI PARTS #	DAI KIT PARTS #
BASES PARA AMORTIGUADOR / STRUT MOUNTS				
07-14		BALERO PARA BASE DE AMORTIGUADOR FRONTAL IZQ. Y DER.	6145	

**BASES PARA AMORTIGUADOR
STRUT MOUNTS**



6145



CONTINUACIÓN... TT

		28	APLICACIÓN / DESCRIPTION	DAI PARTS #
MISCELÁNEOS / AUTOMOTIVE RUBBER PARTS				
	98-06		BUJE PARA EJE TRASERO IZQUIERDO Y DERECHO	DAI-1426037
	99-06		BUJES PARA HORQUILLA INFERIOR POLIURETANO KIT	9800
			BUJES PARA HORQUILLA INFERIOR POLIURETANO KIT CON CASQUILLO	9809
			BUJE PARA HORQUILLA INFERIOR GRANDE CON CEJA BUJE INTERNO CHICO	64650
			BUJE PARA HORQUILLA INFERIOR GRANDE CON CEJA BUJE INTERNO GRANDE	64651
			BUJE PARA HORQUILLA INFERIOR GRANDE (SIN CEJA BUJE INTERNO GRANDE)	64760
			TORNILLO ESTABILIZADOR FRONTAL DERECHO	DAI-2126002
			BUJE PARA EJE TRASERO	DAI-1J0-501-541
			BUJE PARA HORQUILLA CHICO	DAI-191-407-182
	07-10		TORNILLO ESTABILIZADOR FRONTAL	DAI-2126010
	07-14		BUJE PARA HORQUILLA INFERIOR CHICO	DAI-1426011

TT QUATTRO

SOPORTES / TRANSMISSION & MOTOR MOUNTS			
L4 1.8	07-13	SOPORTE PARA MOTOR	7654-H
L4 2.0	08-15		
L4 1.9	12-13	SOPORTE PARA MOTOR TRASERO STD. TORQUE STRUT	7776
L4 2.0			
L5 2.5			



CONTINUACIÓN... TT QUATTRO

  28		APLICACIÓN / DESCRIPTION	DAI PARTS #
SOPORTES / TRANSMISSION & MOTOR MOUNTS			
L4 2.0	09-15	SOPORTE PARA TRANSMISIÓN	7211
		SOPORTE PARA MOTOR TRASERO TORQUE STRUT	7254



VARIOS

MISCELÁNEOS / AUTOMOTIVE RUBBER PARTS		
	COPLÉ PARA DIRECCIÓN SINFÍN DE .690 mm (NO REQUIERE PERNOS)	613
	GALLETA PARA DIRECCIÓN HID. (NO REQUIERE PERNOS COMPLETO 613 CON BUJES)	627





A large sheet of white paper with horizontal ruling lines, held in place by a paperclip at the top center. The paper has a slightly distressed, torn-edge appearance at the bottom.



BMW

128i



28

APLICACIÓN / DESCRIPTION

**DAI
PARTS #**

SOPORTES / TRANSMISSION & MOTOR MOUNTS

L6 3.0	08-13	SOPORTE PARA MOTOR IZQUIERDO Y DERECHO	7468-H
--------	-------	---	--------

**SOPORTES
TRANSMISSION & MOTOR MOUNTS**



7468-H

135i

SOPORTES / TRANSMISSION & MOTOR MOUNTS

L6 3.0	08-13	SOPORTE PARA MOTOR IZQUIERDO Y DERECHO	7468-H
--------	-------	---	--------

**SOPORTES
TRANSMISSION & MOTOR MOUNTS**



7468-H

316i

SOPORTES / TRANSMISSION & MOTOR MOUNTS

L4 1.6	01-05	SOPORTE PARA MOTOR IZQUIERDO Y DERECHO	7532-H
L4 1.8			

**SOPORTES
TRANSMISSION & MOTOR MOUNTS**



7532-H



318D



28

APLICACIÓN / DESCRIPTION

**DAI
PARTS #**

SOPORTES / TRANSMISSION & MOTOR MOUNTS

L4 2.0	01-05	SOPORTE PARA MOTOR IZQUIERDO Y DERECHO	7532-H
--------	-------	---	--------

**SOPORTES
TRANSMISSION & MOTOR MOUNTS**



7532-H

318i, 318is

SOPORTES / TRANSMISSION & MOTOR MOUNTS

L4 1.8	91-95	SOPORTE PARA MOTOR IZQUIERDO Y DERECHO	7532-H
L4 1.9	96-99		

**SOPORTES
TRANSMISSION & MOTOR MOUNTS**



7532-H

320i

SOPORTES / TRANSMISSION & MOTOR MOUNTS

L4 2.0	98-00	SOPORTE PARA MOTOR IZQUIERDO Y DERECHO	7532-H
L4 2.2	00-07		

**SOPORTES
TRANSMISSION & MOTOR MOUNTS**



7532-H

323ci

SOPORTES / TRANSMISSION & MOTOR MOUNTS

L6 2.5	00-06	SOPORTE PARA MOTOR IZQUIERDO Y DERECHO	7532-H
--------	-------	---	--------

**SOPORTES
TRANSMISSION & MOTOR MOUNTS**



7532-H



323i

 		APLICACIÓN / DESCRIPTION	DAI PARTS #
SOPORTES / TRANSMISSION & MOTOR MOUNTS			
L4 2.3	99-00	SOPORTE PARA MOTOR IZQUIERDO Y DERECHO	7532-H
L6 2.5	98-00		
	06-07		
L4 2.5	06-12	SOPORTE PARA MOTOR IZQUIERDO Y DERECHO	7468-H

**SOPORTES
TRANSMISSION & MOTOR MOUNTS**



7532-H



7468-H

323is

 		APLICACIÓN / DESCRIPTION	DAI PARTS #
SOPORTES / TRANSMISSION & MOTOR MOUNTS			
L6 2.5	98-99	SOPORTE PARA MOTOR IZQUIERDO Y DERECHO	7532-H

**SOPORTES
TRANSMISSION & MOTOR MOUNTS**



7532-H

325i

 		APLICACIÓN / DESCRIPTION	DAI PARTS #
SOPORTES / TRANSMISSION & MOTOR MOUNTS			
L4 2.5	05-12	SOPORTE PARA MOTOR IZQUIERDO Y DERECHO	7468-H
L6 2.5	91-95	SOPORTE PARA MOTOR IZQUIERDO Y DERECHO	7532-H
	01-05		

**SOPORTES
TRANSMISSION & MOTOR MOUNTS**



7532-H



7468-H



325is

28

APLICACIÓN / DESCRIPTION
**DAI
PARTS #**
SOPORTES / TRANSMISSION & MOTOR MOUNTS

L6 2.5	91-95	SOPORTE PARA MOTOR IZQUIERDO Y DERECHO	7532-H
--------	-------	---	--------

**SOPORTES
TRANSMISSION & MOTOR MOUNTS**

7532-H
325ix
SOPORTES / TRANSMISSION & MOTOR MOUNTS

L6 2.5	01-05	SOPORTE PARA MOTOR IZQUIERDO Y DERECHO	7532-H
--------	-------	---	--------

**SOPORTES
TRANSMISSION & MOTOR MOUNTS**

7532-H
328i
SOPORTES / TRANSMISSION & MOTOR MOUNTS

L6 3.0	07-10	SOPORTE PARA MOTOR IZQUIERDO Y DERECHO	7468-H
V6 3.0	05-12		

**SOPORTES
TRANSMISSION & MOTOR MOUNTS**

7468-H
328xi
SOPORTES / TRANSMISSION & MOTOR MOUNTS

L6 3.0	07-08	SOPORTE PARA MOTOR IZQUIERDO Y DERECHO	7468-H
--------	-------	---	--------

**SOPORTES
TRANSMISSION & MOTOR MOUNTS**

7468-H

330ci

  28		APLICACIÓN / DESCRIPTION	DAI PARTS #
SOPORTES / TRANSMISSION & MOTOR MOUNTS			
L6 3.0	01-06	SOPORTE PARA MOTOR IZQUIERDO Y DERECHO	7532-H



330i

SOPORTES / TRANSMISSION & MOTOR MOUNTS			
L6 3.0	01-05	SOPORTE PARA MOTOR IZQUIERDO Y DERECHO	7532-H
V6 3.0	06-12	SOPORTE PARA MOTOR IZQUIERDO Y DERECHO	7468-H
	00-07	SOPORTE PARA MOTOR IZQUIERDO Y DERECHO	7532-H



335i, 335xi

SOPORTES / TRANSMISSION & MOTOR MOUNTS			
L6 3.0	07-08	SOPORTE PARA MOTOR IZQUIERDO Y DERECHO	7468-H





525i

SOPORTES / TRANSMISSION & MOTOR MOUNTS			
L4 2.5	00-07	SOPORTE PARA MOTOR IZQUIERDO Y DERECHO	7532-H
L6 2.5	03-05	SOPORTE PARA MOTOR DERECHO	7613-H
V6 3.0	06-07		



CONTINUACIÓN... 525I

 		APLICACIÓN / DESCRIPTION	DAI PARTS #
SOPORTES / TRANSMISSION & MOTOR MOUNTS			
L6 2.5	03-05	SOPORTE PARA MOTOR IZQUIERDO	7614-H
V6 3.0	06-07		

528 i

SOPORTES / TRANSMISSION & MOTOR MOUNTS			
L6 3.0	08-10	SOPORTE PARA MOTOR DERECHO	7613-H
		SOPORTE PARA MOTOR IZQUIERDO	7614-H

528 ix

SOPORTES / TRANSMISSION & MOTOR MOUNTS			
L6 3.0	09-10	SOPORTE PARA MOTOR IZQUIERDO Y DERECHO	7613-H
		SOPORTE PARA MOTOR IZQUIERDO	7614-H

530i

SOPORTES / TRANSMISSION & MOTOR MOUNTS			
L6 3.0	04-07	SOPORTE PARA MOTOR DERECHO	7613-H
		SOPORTE PARA MOTOR IZQUIERDO	7614-H



535i

		APLICACIÓN / DESCRIPTION	DAI PARTS #
SOPORTES / TRANSMISSION & MOTOR MOUNTS			
L6 3.5	89-93	SOPORTE PARA MOTOR IZQUIERDO Y DERECHO	7532-H
V6 3.5	96-04	SOPORTE PARA MOTOR DERECHO	7564-H
		SOPORTE PARA MOTOR IZQUIERDO	7565-H
L6 3.0	09-10	SOPORTE PARA MOTOR DERECHO	7613-H
		SOPORTE PARA MOTOR IZQUIERDO	7614-H



535ix

SOPORTES / TRANSMISSION & MOTOR MOUNTS			
L6 3.0	09-10	SOPORTE PARA MOTOR DERECHO	7613-H
		SOPORTE PARA MOTOR IZQUIERDO	7614-H



540i

SOPORTES / TRANSMISSION & MOTOR MOUNTS			
V8 4.4	96-03	SOPORTE PARA MOTOR DERECHO	7564-H
		SOPORTE PARA MOTOR IZQUIERDO	7565-H



704ii

 		APLICACIÓN / DESCRIPTION	DAI PARTS #
SOPORTES / TRANSMISSION & MOTOR MOUNTS			
V8 4.0	94-96	SOPORTE PARA MOTOR DERECHO	7564-H
		SOPORTE PARA MOTOR IZQUIERDO	7565-H



728i

SOPORTES / TRANSMISSION & MOTOR MOUNTS			
L4 2.8	95-01	SOPORTE PARA MOTOR DERECHO	7564-H
		SOPORTE PARA MOTOR IZQUIERDO	7565-H



730i

SOPORTES / TRANSMISSION & MOTOR MOUNTS			
V6 3.0	94-01	SOPORTE PARA MOTOR DERECHO	7564-H
		SOPORTE PARA MOTOR IZQUIERDO	7565-H



735i, 735ii

SOPORTES / TRANSMISSION & MOTOR MOUNTS			
L6 3.5	88-92	SOPORTE PARA MOTOR IZQUIERDO Y DERECHO	7532-H



740i

 		APLICACIÓN / DESCRIPTION	DAI PARTS #
SOPORTES / TRANSMISSION & MOTOR MOUNTS			
V8 4.0	94-01	SOPORTE PARA MOTOR DERECHO	7564-H
		SOPORTE PARA MOTOR IZQUIERDO	7565-H



740iL

		APLICACIÓN / DESCRIPTION	DAI PARTS #
SOPORTES / TRANSMISSION & MOTOR MOUNTS			
V8 4.4	96-01	SOPORTE PARA MOTOR DERECHO	7564-H
		SOPORTE PARA MOTOR IZQUIERDO	7565-H



750i

		APLICACIÓN / DESCRIPTION	DAI PARTS #
SOPORTES / TRANSMISSION & MOTOR MOUNTS			
V12 5.4	94-01	SOPORTE PARA MOTOR DERECHO	7564-H
		SOPORTE PARA MOTOR IZQUIERDO	7565-H



750iL

		APLICACIÓN / DESCRIPTION	DAI PARTS #
SOPORTES / TRANSMISSION & MOTOR MOUNTS			
V12 5.4	95-01	SOPORTE PARA MOTOR DERECHO	7564-H
		SOPORTE PARA MOTOR IZQUIERDO	7565-H



M5

28		APLICACIÓN / DESCRIPTION	DAI PARTS #
SOPORTES / TRANSMISSION & MOTOR MOUNTS			
V10 5.0	00-03	SOPORTE PARA MOTOR DERECHO	7564-H
		SOPORTE PARA MOTOR IZQUIERDO	7565-H

SERIE 3

28		APLICACIÓN / DESCRIPTION	DAI PARTS #	DAI KIT PARTS #
BASES PARA AMORTIGUADOR / STRUT MOUNTS				
99-05		BASE PARA AMORTIGUADOR TRASERA IZQUIERDA Y DERECHA (E46)	6738	6738-KIT
92-98		BASE PARA AMORTIGUADOR FRONTAL IZQUIERDA Y DERECHA (E36)	6746	6746-KIT
99-05		BASE PARA AMORTIGUADOR FRONTAL IZQUIERDA Y DERECHA (E46)	6747	6747-KIT

SERIE 5

28		APLICACIÓN / DESCRIPTION	DAI PARTS #	DAI KIT PARTS #
BASES PARA AMORTIGUADOR / STRUT MOUNTS				
96-04		BASE PARA AMORTIGUADOR FRONTAL IZQUIERDA Y DERECHA (E39)	6747	6747-KIT



X3

28	APLICACIÓN / DESCRIPTION	DAI PARTS #	DAI KIT PARTS #
BASES PARA AMORTIGUADOR / STRUT MOUNTS			
04-08	BASE PARA AMORTIGUADOR FRONTAL IZQUIERDA Y DERECHA	6747	6747-KIT
03-10	BASE PARA AMORTIGUADOR TRASERA IZQUIERDA Y DERECHA	7625	



X5

28	APLICACIÓN / DESCRIPTION	DAI PARTS #
SOPORTES / TRANSMISSION & MOTOR MOUNTS		
V8 4.4	SOPORTE PARA MOTOR IZQUIERDO Y DERECHO	7615-H
V8 4.6		
V8 4.8		



28	APLICACIÓN / DESCRIPTION	DAI PARTS #	DAI KIT PARTS #
BASES PARA AMORTIGUADOR / STRUT MOUNTS			
00-05	BASE PARA AMORTIGUADOR TRASERA IZQUIERDA Y DERECHA		7287-KIT



Z3

 		APLICACIÓN / DESCRIPTION	DAI PARTS #
SOPORTES / TRANSMISSION & MOTOR MOUNTS			
L4 1.9	96-98	SOPORTE PARA MOTOR IZQUIERDO Y DERECHO	7532-H

**SOPORTES
TRANSMISSION & MOTOR MOUNTS**

7532-H

		APLICACIÓN / DESCRIPTION	DAI PARTS #	DAI KIT PARTS #
BASES PARA AMORTIGUADOR / STRUT MOUNTS				
96-02		BASE PARA AMORTIGUADOR TRASERA IZQUIERDA Y DERECHA	6738	6738-KIT

**BASES PARA AMORTIGUADOR
STRUT MOUNTS**

6738

6738-KIT
Z4

 		APLICACIÓN / DESCRIPTION	DAI PARTS #
SOPORTES / TRANSMISSION & MOTOR MOUNTS			
L6 2.5	03-05	SOPORTE PARA MOTOR IZQUIERDO Y DERECHO	7532-H

**SOPORTES
TRANSMISSION & MOTOR MOUNTS**

7532-H

Z4i

 		APLICACIÓN / DESCRIPTION	DAI PARTS #
SOPORTES / TRANSMISSION & MOTOR MOUNTS			
L4 2.0	95-09	SOPORTE PARA MOTOR IZQUIERDO Y DERECHO	7532-H

**SOPORTES
TRANSMISSION & MOTOR MOUNTS**



7532-H

Z4ii

SOPORTES / TRANSMISSION & MOTOR MOUNTS			
L4 2.3	09-11	SOPORTE PARA MOTOR IZQUIERDO Y DERECHO	7468-H

**SOPORTES
TRANSMISSION & MOTOR MOUNTS**



7468-H





A large sheet of white paper with horizontal lines, resembling a notepad or a form for notes, is pinned to the page.



BUICK

ALLURE

 		APLICACIÓN / DESCRIPTION	DAI PARTS #
SOPORTES / TRANSMISSION & MOTOR MOUNTS			
L4 2.4	10-13	SOPORTE PARA MOTOR DERECHO	7771-H
V6 3.0	2010	SOPORTE PARA TRANSMISIÓN	7760-H
V6 3.6 V6 3.8	05-09	SOPORTE PARA MOTOR DERECHO	6838-H
		SOPORTE PARA MOTOR DERECHO	6875-H
		REPUESTO PARA SOPORTE DE TORSIÓN FRONTAL SUPERIOR IZQUIERDO Y DERECHO (7172)	7172-9
		SOPORTE PARA MOTOR FRONTAL SUPERIOR IZQUIERDO Y DERECHO	7362
V8 5.3	2008	SOPORTE PARA MOTOR FRONTAL	7483-H
	08-09	SOPORTE PARA MOTOR TRASERO	7475
		SOPORTE PARA MOTOR FRONTAL SUPERIOR IZQUIERDO Y DERECHO	7484
V6 3.6	2010	SOPORTE PARA TRANSMISIÓN	7760-H

**SOPORTES
TRANSMISSION & MOTOR MOUNTS**



6838-H



6875-H



7172-9



7362



7475



7483-H



7484



7760-H



7771-H

		APLICACIÓN / DESCRIPTION	DAI PARTS #	DAI KIT PARTS #
BASES PARA AMORTIGUADOR / STRUT MOUNTS				
05-09		BASE PARA AMORTIGUADOR FRONTAL IZQUIERDA Y DERECHA		7222-KIT



**BASES PARA AMORTIGUADOR
STRUT MOUNTS**



7222-KIT



CONTINUACIÓN... ALLURE

		APLICACIÓN / DESCRIPTION	DAI PARTS #
MISCELÁNEOS / AUTOMOTIVE RUBBER PARTS			
	05-08	BUJE PARA HORQUILLA GRANDE	DAI-1403005
		BUJE PARA HORQUILLA CHICO	DAI-1403006

ELECTRA

SOPORTES / TRANSMISSION & MOTOR MOUNTS			
V6 3.0	85-90	SOPORTE PARA TRANSMISIÓN FRONTAL IZQUIERDO	6779
V6 3.8			
V8 4.3			
V8 5.7	77-85	SOPORTE PARA MOTOR FRONTAL	6928



	APLICACIÓN / DESCRIPTION	DAI PARTS #	DAI KIT PARTS #
BASES PARA AMORTIGUADOR / STRUT MOUNTS			
85-99	BASE PARA AMORTIGUADOR FRONTAL IZQUIERDA Y DERECHA	6726	6726-KIT
	BASE PARA AMORTIGUADOR TRASERA IZQUIERDA Y DERECHA	6732	6732-KIT



ENCLAVE

 		APLICACIÓN / DESCRIPTION	DAI PARTS #
SOPORTES / TRANSMISSION & MOTOR MOUNTS			
V6 3.6	07-15	SOPORTE PARA MOTOR TRASERO DERECHO	7559-H
		SOPORTE PARA MOTOR FRONTAL DERECHO	7735
	09-15	SOPORTE PARA TRANSMISIÓN	7802-H
		SOPORTE PARA MOTOR TRASERO TORQUE STRUT	7587

**SOPORTES
TRANSMISSION & MOTOR MOUNTS**



7559-H



7587



7735



7802-H

ENCORE

SOPORTES / TRANSMISSION & MOTOR MOUNTS			
L4 1.4	13-15	SOPORTE PARA TRANSMISIÓN	7496-H
		SOPORTE PARA MOTOR TRASERO	7499
		COMPLEMENTO PARA SOPORTE DE MOTOR TRASERO AUT. (7499)	7555

**SOPORTES
TRANSMISSION & MOTOR MOUNTS**



7496-H



7499



7555

		APLICACIÓN / DESCRIPTION	DAI PARTS #	DAI KIT PARTS #
BASES PARA AMORTIGUADOR / STRUT MOUNTS				
14-16		BASE PARA AMORTIGUADOR FRONTAL IZQUIERDA Y DERECHA	7385	
		BASE PARA AMORTIGUADOR TRASERA IZQUIERDA Y DERECHA	7386	

**BASES PARA AMORTIGUADOR
STRUT MOUNTS**





7385



7386



LACROSSE

 		APLICACIÓN / DESCRIPTION	DAI PARTS #
SOPORTES / TRANSMISSION & MOTOR MOUNTS			
L4 2.4	10-14	SOPORTE PARA MOTOR TRASERO	7313
	10-15	SOPORTE PARA MOTOR FRONTAL	7602
	11-16	SOPORTE PARA MOTOR DERECHO	7771-H
V6 3.0	10-15	SOPORTE PARA MOTOR TRASERO	7313
		SOPORTE PARA MOTOR FRONTAL	7602
		SOPORTE PARA TRANSMISIÓN	7760-H
V6 3.6	10-16	SOPORTE PARA MOTOR TRASERO	7313
		SOPORTE PARA MOTOR FRONTAL	7602
		SOPORTE PARA TRANSMISIÓN	7760-H
V8 5.3	08-09	SOPORTE PARA MOTOR TRASERO	7475
		SOPORTE PARA MOTOR FRONTAL	7483-H
		SOPORTE PARA MOTOR FRONTAL SUPERIOR IZQUIERDO Y DERECHO	7484

SOPORTES TRANSMISSION & MOTOR MOUNTS	
	
7313	7475
	
7483-H	7484
	
7602	7760-H



		APLICACIÓN / DESCRIPTION	DAI PARTS #	DAI KIT PARTS #
BASES PARA AMORTIGUADOR / STRUT MOUNTS				
05-08		BASE PARA AMORTIGUADOR FRONTAL IZQUIERDA Y DERECHA		7222-KIT



CONTINUACIÓN... LACROSSE

 		APLICACIÓN / DESCRIPTION	DAI PARTS #
MISCELÁNEOS / AUTOMOTIVE RUBBER PARTS			
05-08		BUJE PARA HORQUILLA GRANDE	DAI-1403005
		BUJE PARA HORQUILLA CHICO	DAI-1403006
05-09		TORNILLO ESTABILIZADOR	DAI-15851956
10-13		TOPE PARA AMORTIGUADOR FRONTAL Y TRASERO IZQUIERDO Y DERECHO	D-0621



LE SABRE

SOPORTES / TRANSMISSION & MOTOR MOUNTS			
L4 2.2	1993	REPUESTO PARA SOPORTE DE MOTOR DERECHO	6837-9
		REPUESTO PARA SOPORTE DE MOTOR DERECHO	6837-H
V6 3.0	86-91	SOPORTE PARA TRANSMISIÓN FRONTAL IZQUIERDO	6779
V6 3.1	90-94	SOPORTE DE TORSIÓN FRONTAL SUPERIOR	6781
		SOPORTE PARA TRANSMISIÓN	6920
	95-01	SOPORTE PARA MOTOR DERECHO INFERIOR	6838-H



CONTINUACIÓN... LE SABRE

 		APLICACIÓN / DESCRIPTION	DAI PARTS #
SOPORTES / TRANSMISSION & MOTOR MOUNTS			
V6 3.1	95-01	SOPORTE PARA MOTOR DERECHO INFERIOR	6875-H
		SOPORTE PARA MOTOR FRONTAL SUPERIOR IZQUIERDO Y DERECHO	7166
		REPUESTO PARA SOPORTE DE TORSIÓN FRONTAL SUPERIOR IZQUIERDO Y DERECHO (7172)	7172-9
		SOPORTE PARA TRANSMISIÓN	7239-H
V6 3.4	91-97	SOPORTE PARA MOTOR FRONTAL DERECHO	6918-H
		SOPORTE PARA TRANSMISIÓN	7239-H
	92-93	SOPORTE PARA TRANSMISIÓN	6920
V6 3.8	76-77	SOPORTE PARA MOTOR IZQUIERDO	6790
	76-85	SOPORTE PARA MOTOR DERECHO	6971
		SOPORTE PARA TRANSMISIÓN	6770
	86-91	SOPORTE PARA TRANSMISIÓN FRONTAL IZQUIERDO	6779
		SOPORTE PARA TRANSMISIÓN TRASERO DERECHO	6930
	1998	SOPORTE PARA MOTOR DERECHO INFERIOR	6838-H
	98-99	SOPORTE PARA TRANSMISIÓN	7239-H
		SOPORTE PARA MOTOR DERECHO INFERIOR	6875-H
		SOPORTE PARA MOTOR FRONTAL SUPERIOR IZQUIERDO Y DERECHO	7166
		REPUESTO PARA SOPORTE DE TORSIÓN FRONTAL SUPERIOR IZQUIERDO Y DERECHO (7172)	7172-9



CONTINUACIÓN... LE SABRE

	APLICACIÓN / DESCRIPTION	DAI PARTS #	DAI KIT PARTS #
BASES PARA AMORTIGUADOR / STRUT MOUNTS			
86-05	BASE PARA AMORTIGUADOR TRASERA IZQUIERDA Y DERECHA	1821	1821-KIT
85-99	BASE PARA AMORTIGUADOR FRONTAL IZQUIERDA Y DERECHA	6726	6726-KIT
	BASE PARA AMORTIGUADOR TRASERA IZQUIERDA Y DERECHA	6732	6732-KIT



LUCERNE

	APLICACIÓN / DESCRIPTION	DAI PARTS #
SOPORTES / TRANSMISSION & MOTOR MOUNTS		
V6 3.9 09-11	SOPORTE PARA MOTOR TRASERO	7585-H



PARK AVENUE

	APLICACIÓN / DESCRIPTION	DAI PARTS #	DAI KIT PARTS #
BASES PARA AMORTIGUADOR / STRUT MOUNTS			
85-96	BASE PARA AMORTIGUADOR FRONTAL IZQUIERDA Y DERECHA	6726	6726-KIT



CONTINUACIÓN... PARK AVENUE

28	APLICACIÓN / DESCRIPTION	DAI PARTS #	DAI KIT PARTS #
BASES PARA AMORTIGUADOR / STRUT MOUNTS			
85-96	BASE PARA AMORTIGUADOR TRASERA IZQUIERDA Y DERECHA	6732	6732-KIT

REGAL

28	APLICACIÓN / DESCRIPTION	DAI PARTS #	
SOPORTES / TRANSMISSION & MOTOR MOUNTS			
L4 2.0	11-15	SOPORTE PARA MOTOR FRONTAL	7602
	11-15	SOPORTE PARA MOTOR TRASERO	7313
	11-17	SOPORTE PARA MOTOR DERECHO	7771-H
	13-16	SOPORTE PARA TRANSMISIÓN	7760-H
	14-17	SOPORTE PARA MOTOR DERECHO	7772-H
L4 2.4	11-17	SOPORTE PARA MOTOR DERECHO	7771-H
V6 2.8	88-93	SOPORTE PARA MOTOR DERECHO INFERIOR	6838-H
		SOPORTE PARA MOTOR DERECHO INFERIOR	6875-H
		SOPORTE DE TORSIÓN FRONTAL SUPERIOR	6781
		SOPORTE PARA TRANSMISIÓN	6920
V6 3.1	88-93	SOPORTE DE TORSIÓN FRONTAL SUPERIOR	6781
		SOPORTE PARA TRANSMISIÓN	6920
	88-96	SOPORTE PARA MOTOR DERECHO INFERIOR	6838-H
		SOPORTE PARA MOTOR DERECHO INFERIOR	6875-H



CONTINUACIÓN... REGAL

 		APLICACIÓN / DESCRIPTION	DAI PARTS #
SOPORTES / TRANSMISSION & MOTOR MOUNTS			
V6 3.1	94-96	SOPORTE PARA MOTOR FRONTAL SUPERIOR IZQUIERDO Y DERECHO	7166
		REPUESTO PARA SOPORTE DE TORSIÓN FRONTAL SUPERIOR IZQUIERDO Y DERECHO (7172)	7172-9
		SOPORTE PARA TRANSMISIÓN	7239-H

V6 3.8	90-93	SOPORTE PARA TRANSMISIÓN	6920	
	90-95	SOPORTE PARA MOTOR IZQUIERDO	6871	
	90-04	SOPORTE PARA MOTOR DERECHO INFERIOR	6838-H	
	94-96	SOPORTE PARA TRANSMISIÓN	7239-H	
	96-04	SOPORTE PARA TRANSMISIÓN		6844
		SOPORTE PARA MOTOR DERECHO		6875-H
		REPUESTO PARA SOPORTE DE TORSIÓN FRONTAL SUPERIOR IZQUIERDO Y DERECHO (7172)		7172-9
		SOPORTE PARA MOTOR FRONTAL SUPERIOR IZQUIERDO Y DERECHO		7362

**SOPORTES
TRANSMISSION & MOTOR MOUNTS**



6838-H



6781



6844



6875-H



6920



7166



7172-9



7239-H



7362

 		APLICACIÓN / DESCRIPTION	DAI PARTS #	DAI KIT PARTS #
BASES PARA AMORTIGUADOR / STRUT MOUNTS				
88-96	BASE PARA AMORTIGUADOR FRONTAL IZQUIERDA Y DERECHA		6720	6720-KIT

**BASES PARA AMORTIGUADOR
STRUT MOUNTS**



6720



6720-KIT



CONTINUACIÓN... REGAL

28	APLICACIÓN / DESCRIPTION	DAI PARTS #	DAI KIT PARTS #
BASES PARA AMORTIGUADOR / STRUT MOUNTS			
88-96	BASE PARA AMORTIGUADOR TRASERA IZQUIERDA Y DERECHA	6735	6735-KIT
97-04	BASE PARA AMORTIGUADOR FRONTAL IZQUIERDA Y DERECHA		7222-KIT



28	APLICACIÓN / DESCRIPTION	DAI PARTS #
MISCELÁNEOS / AUTOMOTIVE RUBBER PARTS		
88-96	TOPE PARA AMORTIGUADOR FRONTAL IZQUIERDO Y DERECHO	D-0622
97-04	BUJE PARA HORQUILLA GRANDE	DAI-1403005
	BUJE PARA HORQUILLA CHICO	DAI-1403006





RENDEZVOUS

 		APLICACIÓN / DESCRIPTION	DAI PARTS #
SOPORTES / TRANSMISSION & MOTOR MOUNTS			
V6 3.4 V6 3.5 V6 3.6	02-07	SOPORTE PARA MOTOR DERECHO INFERIOR	6838-H
		SOPORTE PARA TRANSMISIÓN AUT. 4 VEL.	6844
		SOPORTE PARA MOTOR DERECHO INFERIOR	6875-H
		SOPORTE PARA MOTOR FRONTAL SUPERIOR IZQUIERDO Y DERECHO	7123



	APLICACIÓN / DESCRIPTION	DAI PARTS #	DAI KIT PARTS #
BASES PARA AMORTIGUADOR / STRUT MOUNTS			
02-07	BASE PARA AMORTIGUADOR FRONTAL IZQUIERDA Y DERECHA		7222-KIT



 		APLICACIÓN / DESCRIPTION	DAI PARTS #
MISCELÁNEOS / AUTOMOTIVE RUBBER PARTS			
	02-07	BUJE PARA HORQUILLA GRANDE	DAI-1403005
		BUJE PARA HORQUILLA CHICO	DAI-1403006



RIVERA

 28	APLICACIÓN / DESCRIPTION	DAI PARTS #	DAI KIT PARTS #
BASES PARA AMORTIGUADOR / STRUT MOUNTS			
95-99	BASE PARA AMORTIGUADOR TRASERA IZQUIERDA Y DERECHA	1821	1821-KIT

SKYHAWK

BASES PARA AMORTIGUADOR / STRUT MOUNTS			
82-89	BASE PARA AMORTIGUADOR TRASERA IZQUIERDA Y DERECHA	1821	1821-KIT
82-84	BASE PARA AMORTIGUADOR FRONTAL IZQUIERDA Y DERECHA	6711	6711-KIT



 28	APLICACIÓN / DESCRIPTION	DAI PARTS #
MISCELÁNEOS / AUTOMOTIVE RUBBER PARTS		
82-84	TOPE PARA AMORTIGUADOR FRONTAL IZQUIERDO Y DERECHO	D-0622
82-89	TORNILLO ESTABILIZADOR (7", 203.200 mm)	6102
	TORNILLO ESTABILIZADOR (7", 203.200 mm EQUIPO ORIGINAL)	6106



SKYLARK

 28	APLICACIÓN / DESCRIPTION	DAI PARTS #	DAI KIT PARTS #
BASES PARA AMORTIGUADOR / STRUT MOUNTS			
80-98	BASE PARA AMORTIGUADOR TRASERA IZQUIERDA Y DERECHA	1821	1821-KIT
80-85	BASE PARA AMORTIGUADOR FRONTAL IZQUIERDA Y DERECHA	6666	6666-KIT
	BASE PARA AMORTIGUADOR FRONTAL IZQUIERDA Y DERECHA	6767	6667-KIT
82-98	BASE PARA AMORTIGUADOR FRONTAL IZQUIERDA Y DERECHA	6711	6711-KIT
	BASE PARA AMORTIGUADOR FRONTAL IZQUIERDA Y DERECHA	6731	6731-KIT

BASES PARA AMORTIGUADOR STRUT MOUNTS



1821 1821-KIT



6666 6666-KIT



6667



6667-KIT



6711



6711-KIT



6731



6731-KIT

 28	APLICACIÓN / DESCRIPTION	DAI PARTS #
MISCELÁNEOS / AUTOMOTIVE RUBBER PARTS		
86-98	TORNILLO ESTABILIZADOR (7", 203.200 mm)	6102
	TORNILLO ESTABILIZADOR (7", 203.200 mm EQUIPO ORIGINAL)	6106

MISCELÁNEOS AUTOMOTIVE RUBBER PARTS

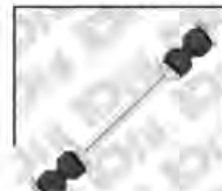

6102



6106



SOMERSET

28		APLICACIÓN / DESCRIPTION	DAI PARTS #	DAI KIT PARTS #
BASES PARA AMORTIGUADOR / STRUT MOUNTS				
85-87		BASE PARA AMORTIGUADOR TRASERA IZQUIERDA Y DERECHA	1821	1821-KIT
		BASE PARA AMORTIGUADOR FRONTAL IZQUIERDA Y DERECHA	6711	6711-KIT

TERRAZA

28		APLICACIÓN / DESCRIPTION	DAI PARTS #
SOPORTES / TRANSMISSION & MOTOR MOUNTS			
V6 3.9	05-07	SOPORTE PARA MOTOR DERECHO INFERIOR	6838-H
		SOPORTE PARA TARNSMISIÓN	6844
		SOPORTE PARA MOTOR DERECHO INFERIOR	6875-H
		REPUESTO PARA SOPORTE DE TORSIÓN FRONTAL SUPERIOR IZQUIERDO Y DERECHO (7172)	7172-9
		SOPORTE PARA MOTOR FRONTAL SUPERIOR IZQUIERDO Y DERECHO	7484



CONTINUACIÓN... TERREZA

28	APLICACIÓN / DESCRIPTION	DAI PARTS #	DAI KIT PARTS #
BASES PARA AMORTIGUADOR / STRUT MOUNTS			
05-07	BASE PARA AMORTIGUADOR FRONTAL IZQUIERDA Y DERECHA		7222-KIT

BASES PARA AMORTIGUADOR STRUT MOUNTS



7222-KIT

28	APLICACIÓN / DESCRIPTION	DAI PARTS #
MISCELÁNEOS / AUTOMOTIVE RUBBER PARTS		
05-07	BUJE PARA HORQUILLA GRANDE	DAI-1403005
	BUJE PARA HORQUILLA CHICO	DAI-1403006
	TORNILLO ESTABILIZADOR	DAI-15851956

MISCELÁNEOS AUTOMOTIVE RUBBER PARTS



DAI-1403005



DAI-1403006



DAI-15851956

VERANO

SOPORTES / TRANSMISSION & MOTOR MOUNTS			
L4 2.0	13-16	SOPORTE PARA TRANSMISIÓN	7760-H
L4 2.4	12-15	SOPORTE PARA MOTOR FRONTAL	7602
		SOPORTE PARA MOTOR DERECHO	7771-H

SOPORTES TRANSMISSION & MOTOR MOUNTS



7602



7760-H



7771-H





A large sheet of white paper with horizontal lines, held in place by a pushpin at the top center. The paper has a slightly torn edge at the bottom.



CADILLAC

BLS

 28	APLICACIÓN / DESCRIPTION	DAI PARTS #
MISCELÁNEOS / AUTOMOTIVE RUBBER PARTS		
05-07	TORNILLO ESTABILIZADOR FRONTAL	DAI-2103009

MISCELÁNEOS AUTOMOTIVE RUBBER PARTS



DAI-2103009

CIMARRON

28	APLICACIÓN / DESCRIPTION	DAI PARTS #	DAI KIT PARTS #
BASES PARA AMORTIGUADOR / STRUT MOUNTS			
82-88	BASE PARA AMORTIGUADOR TRASERA IZQUIERDA Y DERECHA	1821	1821-KIT
	BASE PARA AMORTIGUADOR FRONTAL IZQUIERDA Y DERECHA	6711	6711-KIT

BASES PARA AMORTIGUADOR STRUT MOUNTS



1821



1821-KIT



6711



6711-KIT

 28	APLICACIÓN / DESCRIPTION	DAI PARTS #
MISCELÁNEOS / AUTOMOTIVE RUBBER PARTS		
82-88	TOPE PARA AMORTIGUADOR FRONTAL IZQUIERDO Y DERECHO	D-0622

MISCELÁNEOS AUTOMOTIVE RUBBER PARTS



D-0622



CTS

		APLICACIÓN / DESCRIPTION	DAI PARTS #
SOPORTES / TRANSMISSION & MOTOR MOUNTS			
V6 3.2	03-04	SOPORTE PARA MOTOR IZQUIERDO Y DERCHO	7585-H
V6 3.6	04-07		
V8 5.7	04-05		
V8 6.0	06-07		



DEVILLE



		APLICACIÓN / DESCRIPTION	DAI PARTS #	DAI KIT PARTS #
BASES PARA AMORTIGUADOR / STRUT MOUNTS				
61-05		BASE PARA AMORTIGUADOR TRASERA IZQUIERDA Y DERECHA	1821	1821-KIT
85-97		BASE PARA AMORTIGUADOR FRONTAL IZQUIERDA Y DERECHA	6726	6726-KIT



		APLICACIÓN / DESCRIPTION	DAI PARTS #
MISCELÁNEOS / AUTOMOTIVE RUBBER PARTS			
	85-97	TOPE PARA AMORTIGUADOR FRONTAL IZQUIERDO Y DERECHO	D-0622



ESCALADE

 		APLICACIÓN / DESCRIPTION	DAI PARTS #
SOPORTES / TRANSMISSION & MOTOR MOUNTS			
V8 5.3	02-07	SOPORTE PARA TRANSMISIÓN	1911
		SOPORTE PARA TRANSMISIÓN	1940
		SOPORTE PARA TRANSMISIÓN (4X4)	6874
		SOPORTE PARA MOTOR IZQUIERDO Y DERECHO	7120
V8 5.7	99-00	SOPORTE PARA TRANSMISIÓN	1911
		SOPORTE PARA TRANSMISIÓN	1940
		SOPORTE PARA TRANSMISIÓN (4X4)	6874
		SOPORTE PARA MOTOR IZQUIERDO Y DERECHO	6931
V8 6.0	02-07	SOPORTE PARA TRANSMISIÓN	1911
		SOPORTE PARA TRANSMISIÓN	1940
		SOPORTE PARA TRANSMISIÓN (4X4)	6874
		SOPORTE PARA MOTOR IZQUIERDO Y DERECHO	7120
	07-12	SOPORTE PARA MOTOR IZQUIERDO Y DERECHO	7365-H
V8 6.2	15-16	SOPORTE PARA MOTOR DERECHO	7638-H

SOPORTES TRANSMISSION & MOTOR MOUNTS



1911 1940



6874 6931



7120 7365-H



7638-H

		APLICACIÓN / DESCRIPTION	DAI PARTS #	DAI KIT PARTS #
BASES PARA AMORTIGUADOR / STRUT MOUNTS				
07-11		BASE PARA AMORTIGUADOR FRONTAL IZQUIERDA Y DERECHA		7356-KIT

BASES PARA AMORTIGUADOR STRUT MOUNTS



7356-KIT



CONTINUACIÓN... ESCALADE

		APLICACIÓN / DESCRIPTION	DAI PARTS #
MISCELÁNEOS / AUTOMOTIVE RUBBER PARTS			
	99-06	BUJE PARA HORQUILLA SUPERIOR (4X4)	DAI-K-6395
	02-14	BUJE PARA HORQUILLA SUPERIOR	
	99-10	SOPORTE PARA BARRA DE TORSIÓN	7548

FLEETWOOD

SOPORTES / TRANSMISSION & MOTOR MOUNTS			
V8 4.1	85-87	SOPORTE PARA TRANSMISIÓN FRONTAL IZQUIERDO	6779
V8 4.5	88-90	SOPORTE PARA TRANSMISIÓN FRONTAL IZQUIERDO	6779
		SOPORTE PARA TRANSMISIÓN TRASERO DERECHO	6930



		APLICACIÓN / DESCRIPTION	DAI PARTS #	
BASES PARA AMORTIGUADOR / STRUT MOUNTS				
92-93		BASE PARA AMORTIGUADOR FRONTAL IZQUIERDA Y DERECHA	6726	6726-KIT
85-93		BASE PARA AMORTIGUADOR TRASERA IZQUIERDA Y DERECHA	6732	6732-KIT



SEVILLE

28		APLICACIÓN / DESCRIPTION	DAI PARTS #	DAI KIT PARTS #
BASES PARA AMORTIGUADOR / STRUT MOUNTS				
94-04		BASE PARA AMORTIGUADOR TRASERA IZQUIERDA Y DERECHA	1821	1821-KIT



SRX

28		APLICACIÓN / DESCRIPTION	DAI PARTS #
SOPORTES / TRANSMISSION & MOTOR MOUNTS			
V6 3.0	10-11	SOPORTE PARA MOTOR TRASERO	7313
		SOPORTE PARA MOTOR FRONTAL	7602
		SOPORTE PARA TRANSMISIÓN	7760-H
		SOPORTE PARA MOTOR DERECHO	7761-H
V6 3.6	04-09	SOPORTE PARA MOTOR IZQUIERDO Y DERECHO	7585-H
	10-15	SOPORTE PARA MOTOR TRASERO	7313
		SOPORTE PARA MOTOR FRONTAL	7602
	12-15	SOPORTE PARA TRANSMISIÓN	7760-H
	12-16	SOPORTE PARA MOTOR DERECHO	7761-H
V8 4.6	04-09	SOPORTE PARA MOTOR IZQUIERDO Y DERECHO	7585-H



STS

 		APLICACIÓN / DESCRIPTION	DAI PARTS #
SOPORTES / TRANSMISSION & MOTOR MOUNTS			
V6 3.6	05-11	SOPORTE PARA MOTOR IZQUIERDO Y DERECHO	7585-H
V8 4.4	06-09		
V8 4.6	05-10		

**SOPORTES
TRANSMISSION & MOTOR MOUNTS**



7585-H

XTS

SOPORTES / TRANSMISSION & MOTOR MOUNTS			
V6 3.0	13-15	SOPORTE PARA MOTOR FRONTAL	7602
	13-16	SOPORTE PARA MOTOR TRASERO	7313
V6 3.6	13-16	SOPORTE PARA TRANSMISIÓN	7760-H

**SOPORTES TRANSMISSION
& MOTOR MOUNTS**



7313



7602



7760-H





CHEVROLET

ACADIA

 		APLICACIÓN / DESCRIPTION	DAI PARTS #
SOPORTES / TRANSMISSION & MOTOR MOUNTS			
V6 3.6	07-15	SOPORTE PARA MOTOR TRASERO TORQUE STRUT	7587
		SOPORTE PARA MOTOR TRASERO DERECHO	7559-H
		SOPORTE PARA MOTOR FRONTAL DERECHO	7735

SOPORTES TRANSMISSION & MOTOR MOUNTS



7559-H



7587

NUEVO



7735

ASTRA

SOPORTES / TRANSMISSION & MOTOR MOUNTS			
L4 1.8	00-08	SOPORTE PARA MOTOR FRONTAL AUT.	7011
		REPUESTO PARA SOPORTE DE MOTOR FRONTAL TRANSMISIÓN AUT. (7011 Y 7022)	7011-9
		SOPORTE PARA TRANSMISIÓN STD. Y AUT.	7014
		SOPORTE PARA MOTOR TRASERO IZQUIERDO	7020
		SOPORTE PARA MOTOR FRONTAL STD.	7021
		SOPORTE PARA MOTOR FRONTAL AUT.	7022
		SOPORTE PARA MOTOR DERECHO	7023

SOPORTES TRANSMISSION & MOTOR MOUNTS



7011



7011-9



7014



7020



7021



7022



7023



CONTINUACIÓN... ASTRA

  28		APLICACIÓN / DESCRIPTION	DAI PARTS #	SOPORTES TRANSMISION & MOTOR MOUNTS	
SOPORTES / TRANSMISSION & MOTOR MOUNTS					
L4 1.8	00-08	REPUESTO PARA SOPORTE DE MOTOR DERECHO (7023)	7023-9		
		SOPORTE PARA MOTOR FRONTAL STD.	7078		
L4 2.0	04-08	SOPORTE PARA TRANSMISIÓN STD. Y AUT.	7014		
		REPUESTO PARA SOPORTE DE MOTOR FRONTAL TRANSMISIÓN AUT. (7011 Y 7022)	7011-9		
		SOPORTE PARA MOTOR TRASERO IZQUIERDO	7020		
		SOPORTE PARA MOTOR FRONTAL STD.	7021		
		SOPORTE PARA MOTOR FRONTAL AUT.	7022		
		SOPORTE PARA MOTOR DERECHO	7023		
		REPUESTO PARA SOPORTE DE MOTOR DERECHO (7023)	7023-9		
		SOPORTE PARA MOTOR FRONTAL STD.	7078		
L4 2.2	00-08	SOPORTE PARA MOTOR FRONTAL AUT.	7011		
		REPUESTO PARA SOPORTE DE MOTOR FRONTAL TRANSMISIÓN AUT. (7011 Y 7022)	7011-9		
		SOPORTE PARA TRANSMISIÓN STD. Y AUT.	7014		
		SOPORTE PARA MOTOR TRASERO IZQUIERDO	7020		
		SOPORTE PARA MOTOR FRONTAL STD.	7021		
		SOPORTE PARA MOTOR FRONTAL AUT.	7022		
		SOPORTE PARA MOTOR DERECHO	7023		
		REPUESTO PARA SOPORTE DE MOTOR DERECHO (7023)	7023-9		
		SOPORTE PARA MOTOR FRONTAL STD.	7078		
L4 2.4	04-08	REPUESTO PARA SOPORTE DE MOTOR FRONTAL TRANSMISIÓN AUT., (7011 Y 7022)	7011-9		
		SOPORTE PARA TRANSMISIÓN STD. Y AUT.	7014		
		SOPORTE PARA MOTOR TRASERO IZQUIERDO	7020		

7011

7011-9

7014

7020

7021

7022

7023

7023-9

7078



CONTINUACIÓN... ASTRA

 		APLICACIÓN / DESCRIPTION	DAI PARTS #
SOPORTES / TRANSMISSION & MOTOR MOUNTS			
L4 2.4	04-08	SOPORTE PARA MOTOR FRONTAL STD.	7021
		SOPORTE PARA MOTOR FRONTAL AUT.	7022
		SOPORTE PARA MOTOR DERECHO	7023
		REPUESTO PARA SOPORTE DE MOTOR DERECHO (7023)	7023-9
		SOPORTE PARA MOTOR FRONTAL STD.	7078



		APLICACIÓN / DESCRIPTION	DAI PARTS #	DAI KIT PARTS #
BASES PARA AMORTIGUADOR / STRUT MOUNTS				
00-08		BASE PARA AMORTIGUADOR FRONTAL IZQUIERDA Y DERECHA	1997	



 		APLICACIÓN / DESCRIPTION	DAI PARTS #
CUBRE POLVOS / C.V. BOOTS			
L4 1.8 L4 2.0	00-04	CUBRE POLVO IZQUIERDO Y DERECHO LADO RUEDA	63103
		CUBRE POLVO IZQUIERDO Y DERECHO LADO CAJA	63104



CONTINUACIÓN... ASTRA

28		APLICACIÓN / DESCRIPTION	DAI PARTS #
CUBRE POLVOS / C.V. BOOTS			
L4 1.8 L4 2.0	00-04	CUBRE POLVO IZQUIERDO Y DERECHO DE DIRECCIÓN	63105
		CUBRE POLVO IZQUIERDO Y DERECHO DE DIRECCIÓN	63106



MISCELÁNEOS / AUTOMOTIVE RUBBER PARTS			
	00-08	TORNILLO ESTABILIZADOR FRONTAL	DAI-2103001
	01-08	TOPE PARA AMORTIGUADOR FRONTAL IZQUIERDO Y DERECHO	D-037
		GOMA SUJETADORA DE ESCAPE	650
		GOMA SUJETADORA DE ESCAPE	6573
		GOMA PARA BARRA ESTABILIZADORA 3/4"	64731
		GOMA PARA BARRA ESTABILIZADORA 1"	64733
		BUJE PARA HORQUILLA INFERIOR CHICO	DAI-352364
		BUJE PARA HORQUILLA INFERIOR GRANDE	DAI-352365

ASTRO

SOPORTES / TRANSMISSION & MOTOR MOUNTS			
L4 2.5	85-90	SOPORTE PARA TRANSMISIÓN	6774
		SOPORTE PARA MOTOR IZQUIERDO	6909



CONTINUACIÓN... ASTRO

 		APLICACIÓN / DESCRIPTION	DAI PARTS #
SOPORTES / TRANSMISSION & MOTOR MOUNTS			
L4 2.5	85-90	SOPORTE PARA MOTOR DERECHO	6983
V6 4.3	85-90	SOPORTE PARA TRANSMISIÓN	6774
	86-05	SOPORTE PARA MOTOR IZQUIERDO Y DERECHO	6640
	91-93	SOPORTE PARA TRANSMISIÓN	6876
	91-05	SOPORTE PARA TRANSMISIÓN	6874
	94-05	SOPORTE PARA TRANSMISIÓN AUT., 4 VEL.	7470-H



6983



7470-H

SOPORTES TRANSMISSION & MOTOR MOUNTS



6640



6774



6874



6876

MISCELÁNEOS / AUTOMOTIVE RUBBER PARTS

90-05	BUJE PARA HORQUILLA SUPERIOR (4X4)	DAI-K-6395
-------	------------------------------------	------------

MISCELÁNEOS AUTOMOTIVE RUBBER PARTS



DAI-K-6395

DEVILLE

		APLICACIÓN / DESCRIPTION	DAI PARTS #	DAI KIT PARTS #
BASES PARA AMORTIGUADOR / STRUT MOUNTS				
1993		BASE PARA AMORTIGUADOR TRASERA IZQUIERDA Y DERECHA	1821	1821-KIT

BASES PARA AMORTIGUADOR STRUT MOUNTS



1821



1821-KIT



AUTOS

 		APLICACIÓN / DESCRIPTION	DAI PARTS #
MISCELÁNEOS / AUTOMOTIVE RUBBER PARTS			
		CONJUNTO DE GOMAS DELANTERAS PARA CASETA	100
		CONJUNTO DE GOMAS TRASERAS PARA CASETA	101
		GOMA TRASERA PARA CASETA	107
		CONJUNTO DE GOMAS TRASERAS PARA CASETA	108



AVALANCHE

SOPORTES / TRANSMISSION & MOTOR MOUNTS			
V8 5.3	02-06	SOPORTE PARA TRANSMISIÓN	1911
		SOPORTE PARA TRANSMISIÓN (4X4)	6874
		SOPORTE PARA MOTOR IZQUIERDO Y DERECHO	7120
V8 5.3 V8 6.0	07-12	SOPORTE PARA MOTOR IZQUIERDO Y DERECHO	7365-H



CONTINUACIÓN... AVALANCHE

28	APLICACIÓN / DESCRIPTION	DAI PARTS #	DAI KIT PARTS #
BASES PARA AMORTIGUADOR / STRUT MOUNTS			
07-12	BASE PARA AMORTIGUADOR FRONTAL IZQUIERDA Y DERECHA 1500		7356-KIT

BASES PARA AMORTIGUADOR STRUT MOUNTS



7356-KIT

28	APLICACIÓN / DESCRIPTION	DAI PARTS #
MISCELÁNEOS / AUTOMOTIVE RUBBER PARTS		
01-10	SOPORTE PARA BARRA DE TORSIÓN	7548
00-06	BUJE PARA HORQUILLA SUPERIOR (4X4) 1500	DAI-K-6395
00-14	BUJE PARA HORQUILLA SUPERIOR 1500	

MISCELÁNEOS AUTOMOTIVE RUBBER PARTS



7548



DAI-K-6395

AVEO

SOPORTES / TRANSMISSION & MOTOR MOUNTS			
L4 1.6	08-18	SOPORTE PARA TRANSMISIÓN STD. Y AUT.	7258
		REPUESTO PARA SOPORTE DE TRANSMISIÓN STD. Y AUT. (7358)	7258-9
		SOPORTE PARA MOTOR DERECHO	7259
		REPUESTO PARA SOPORTE DE MOTOR DERECHO (7259)	7259-9
		SOPORTE PARA MOTOR TRASERO	7260
		REPUESTO PARA SOPORTE DE MOTOR TRASERO (7260)	7260-9

SOPORTES TRANSMISSION & MOTOR MOUNTS



7258



7258-9



7259



7259-9



7260



7260-9



CONTINUACIÓN... AVEO

28		APLICACIÓN / DESCRIPTION	DAI PARTS #	DAI KIT PARTS #
BASES PARA AMORTIGUADOR / STRUT MOUNTS				
08-18		BASE PARA AMORTIGUADOR TRASERA IZQUIERDA Y DERECHA		7284-KIT
		BASE PARA AMORTIGUADOR DELANTERA IZQUIERDA Y DERECHA		7294-KIT



28		APLICACIÓN / DESCRIPTION	DAI PARTS #
CUBRE POLVOS / C.V. BOOTS			
L4 1.6	08-18	CUBRE POLVO IZQUIERDO Y DERECHO LADO RUEDA	63138
		CUBRE POLVO IZQUIERDO Y DERECHO LADO CAJA	63139
		CUBRE POLVO IZQUIERDO Y DERECHO DE DIRECCIÓN	63140
		CUBRE POLVO IZQUIERDO Y DERECHO LADO CAJA CON TRIPOIDE	63171



MISCELÁNEOS / AUTOMOTIVE RUBBER PARTS			
	08-18	BUJES PARA HORQUILLA (POLIURETANO KIT)	9805
		BUJE PARA HORQUILLA INFERIOR GRANDE	DAI-1403023



CONTINUACIÓN... AVEO

	 28	APLICACIÓN / DESCRIPTION	DAI PARTS #
MISCELÁNEOS / AUTOMOTIVE RUBBER PARTS			
	08-18	BUJE PARA HORQUILLA INFERIOR CHICO	DAI-1403024

**MISCELÁNEOS
AUTOMOTIVE RUBBER PARTS**



DAI-1403024

BEL AIR

MISCELÁNEOS / AUTOMOTIVE RUBBER PARTS			
49-57	TORNILLO ESTABILIZADOR (6", 177.800 mm)	6101	
	TORNILLO ESTABILIZADOR (6", 177.800 mm EQUIPO ORIGINAL)	6105	
58-70	TORNILLO ESTABILIZADOR (5", 1542.400 mm)	6100	
	TORNILLO ESTABILIZADOR (5", 1542.400 mm EQUIPO ORIGINAL)	6104	
71-82	TORNILLO ESTABILIZADOR (7", 203.200 mm)	6102	
	TORNILLO ESTABILIZADOR (7", 203.200 mm EQUIPO ORIGINAL)	6106	

**MISCELÁNEOS
AUTOMOTIVE RUBBER PARTS**



6100



6101



6102



6104





6105



6106



BERETTA

 		APLICACIÓN / DESCRIPTION	DAI PARTS #
SOPORTES / TRANSMISSION & MOTOR MOUNTS			
L4 2.0	87-89	SOPORTE PARA MOTOR TRASERO	1909
		SOPORTE PARA MOTOR FRONTAL DERECHO	1971
		SOPORTE PARA MOTOR TRASERO DERECHO	1980
		REPUESTO PARA SOPORTE DE TRANSMISIÓN (6655)	6642
		SOPORTE PARA TRANSMISIÓN	6655
		SOPORTE PARA MOTOR TRASERO DERECHO	6795
L4 2.2	87-91	SOPORTE PARA MOTOR TRASERO	1909
		SOPORTE PARA MOTOR FRONTAL DERECHO	1971
		SOPORTE PARA MOTOR TRASERO DERECHO	1980
		SOPORTE PARA MOTOR TRASEO DERECHO	6638
		REPUESTO PARA SOPORTE DE TRANSMISIÓN (6655)	6642
		SOPORTE PARA TRANSMISIÓN	6655
		SOPORTE PARA MOTOR TRASERO DERECHO	6795
	92-96	REPUESTO PARA SOPORTE MOTOR DERECHO	6837-9
		REPUESTO PARA SOPORTE MOTOR DERECHO	6837-H
	95-96	SOPORTE PARA MOTOR FRONTAL DERECHO INFERIOR (BUJE LARGO 60.24 mm)	6936
L4 2.3	90-91	SOPORTE PARA MOTOR TRASERO	1909
	92-94	REPUESTO PARA SOPORTE MOTOR DERECHO	6837-9
		REPUESTO PARA SOPORTE MOTOR DERECHO	6837-H

**SOPORTES
TRANSMISSION & MOTOR MOUNTS**

1909

1971

1980

6638

6642

6655



6795

6837-H

6837-9

6936

CONTINUACIÓN... BERETTA

		APLICACIÓN / DESCRIPTION	DAI PARTS #
SOPORTES / TRANSMISSION & MOTOR MOUNTS			
L4 2.2	90-91	REPUESTO PARA SOPORTE DE TORSIÓN	7440-9
V6 2.8	87-89	SOPORTE PARA MOTOR TRASERO DERECHO	1980
		SOPORTE PARA MOTOR TRASERO DERECHO	6638
		SOPORTE PARA MOTOR TRASERO DERECHO	6795
	87-91	SOPORTE PARA MOTOR TRASERO	1909
		SOPORTE PARA MOTOR FRONTAL DERECHO	1971
V6 3.1	90-91	SOPORTE PARA MOTOR TRASERO	1909
		SOPORTE PARA MOTOR FRONTAL DERECHO	1971
		SOPORTE PARA MOTOR TRASERO DERECHO	1980
		SOPORTE PARA MOTOR TRASERO DERECHO	6638
		SOPORTE PARA MOTOR TRASERO DERECHO	6795
	92-96	REPUESTO PARA SOPORTE MOTOR DERECHO	6837-9
		REPUESTO PARA SOPORTE MOTOR DERECHO	6837-H
	95-96	SOPORTE PARA MOTOR FRONTAL DERECHO INFERIOR (BUJE LARGO 60.24 mm)	6936



	APLICACIÓN / DESCRIPTION	DAI PARTS #	DAI KIT PARTS #
BASES PARA AMORTIGUADOR / STRUT MOUNTS			
87-96	BASE PARA AMORTIGUADOR TRASERA IZQUIERDA Y DERECHA	1821	1821-KIT



CONTINUACIÓN... BERETTA

28	APLICACIÓN / DESCRIPTION	DAI PARTS #	DAI KIT PARTS #
BASES PARA AMORTIGUADOR / STRUT MOUNTS			
87-96	BASE PARA AMORTIGUADOR FRONTAL IZQUIERDA Y DERECHA	6711	6711-KIT
94-96	BASE PARA AMORTIGUADOR FRONTAL IZQUIERDA Y DERECHA	6731	6731-KIT



28	APLICACIÓN / DESCRIPTION	DAI PARTS #
MISCELÁNEOS / AUTOMOTIVE RUBBER PARTS		
87-96	TORNILLO ESTABILIZADOR (7", 203.200 mm)	6102
	TORNILLO ESTABILIZADOR (7", 203.200 mm EQUIPO ORIGINAL)	6106

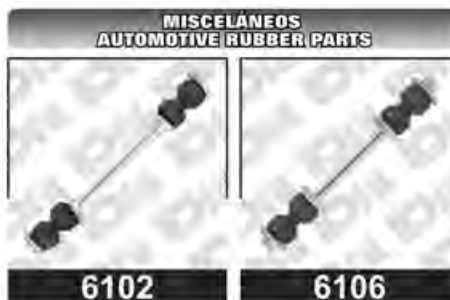

BISCAYNE

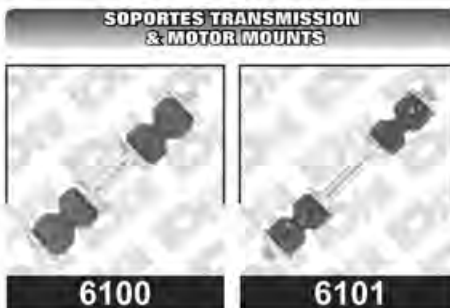
MISCELÁNEOS / AUTOMOTIVE RUBBER PARTS		
49-57	TORNILLO ESTABILIZADOR (6", 177.800 mm)	6101
	TORNILLO ESTABILIZADOR (6", 177.800 mm EQUIPO ORIGINAL)	6105

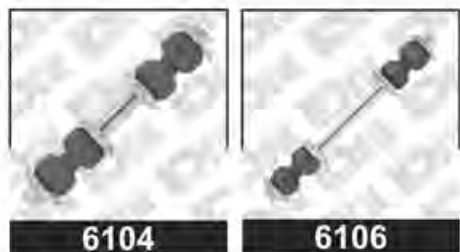
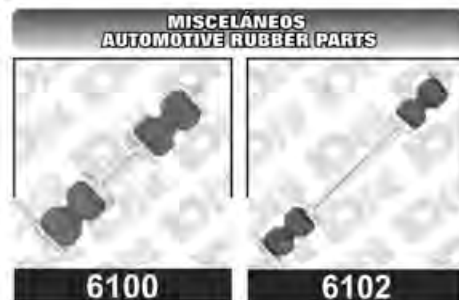

CONTINUACIÓN... BISCAYNE

 28		APLICACIÓN / DESCRIPTION	DAI PARTS #
MISCELÁNEOS / AUTOMOTIVE RUBBER PARTS			
58-70		TORNILLO ESTABILIZADOR (5", 1542.400 mm)	6100
		TORNILLO ESTABILIZADOR (5", 1542.400 mm EQUIPO ORIGINAL)	6104
71-82		TORNILLO ESTABILIZADOR (7", 203.200 mm)	6102
		TORNILLO ESTABILIZADOR (7", 203.200 mm EQUIPO ORIGINAL)	6106



BLAZER

SOPORTES / TRANSMISSION & MOTOR MOUNTS			
L4 1.9	1984	SOPORTE PARA TRANSMISIÓN	1911
		SOPORTE PARA TRANSMISIÓN	1940
	82-85	SOPORTE PARA MOTOR IZQUIERDO Y DERECHO	6771
	83-84	SOPORTE PARA TRANSMISIÓN (4X4)	6874
L4 2.0	83-84	SOPORTE PARA TRANSMISIÓN (2X2)	1911
		SOPORTE PARA TRANSMISIÓN	1940
		SOPORTE PARA TRANSMISIÓN (4X4)	6874



CONTINUACIÓN... BLAZER

 		APLICACIÓN / DESCRIPTION	DAI PARTS #	SOPORTES TRANSMISSION & MOTOR MOUNTS	
SOPORTES / TRANSMISSION & MOTOR MOUNTS					
L4 2.2	83-85	SOPORTE PARA TRANSMISIÓN	1911		
		SOPORTE PARA TRANSMISIÓN	1940	1911	1940
		SOPORTE PARA MOTOR IZQUIERDO	6909		
		SOPORTE PARA MOTOR DERECHO	6983	6640	6774
	94-03	SOPORTE PARA MOTOR IZQUIERDO	7003		
		SOPORTE PARA MOTOR DERECHO	7004	6873	6874
		SOPORTE PARA TRANSMISIÓN	7079		
		REPUESTO PARA SOPORTE DE MOTOR IZQUIERDO Y DERECHO (7003 Y 7004)	7097	6909	6983
L4 2.5	85-87	SOPORTE PARA TRANSMISIÓN	1911		
		SOPORTE PARA TRANSMISIÓN	1940	6909	6983
	85-93	SOPORTE PARA TRANSMISIÓN (4X4)	6874		
		SOPORTE PARA MOTOR IZQUIERDO	6909	7003	7004
		SOPORTE PARA MOTOR DERECHO	6983		
	88-93	SOPORTE PARA TRANSMISIÓN	6774	7079	7097
V6 2.8	82-93	SOPORTE PARA MOTOR IZQUIERDO Y DERECHO	6640		
		SOPORTE PARA TRANSMISIÓN	6774	7003	7004
		SOPORTE PARA TRANSMISIÓN (4X4)	6874		
	83-87	SOPORTE PARA TRANSMISIÓN	1911	7079	7097
		SOPORTE PARA TRANSMISIÓN	1940		
88-94	SOPORTE PARA TRANSMISIÓN (2X2)	6774	7003	7004	
V6 4.3	88-95	SOPORTE PARA MOTOR IZQUIERDO Y DERECHO	6873		



CONTINUACIÓN... BLAZER

 		APLICACIÓN / DESCRIPTION	DAI PARTS #
SOPORTES / TRANSMISSION & MOTOR MOUNTS			
V6 4.3	95-05	SOPORTE PARA TRANSMISIÓN	1911
		SOPORTE PARA TRANSMISIÓN	1940
	96-05	SOPORTE PARA MOTOR IZQUIERDO Y DERECHO	6914



CUBRE POLVOS / C.V. BOOTS			
	97-04	CUBRE POLVO IZQUIERDO Y DERECHO LADO RUEDA (4X4) GRANDE	6337
		CUBRE POLVO IZQUIERDO Y DERECHO LADO RUEDA (4X2)	6338



MISCELÁNEOS / AUTOMOTIVE RUBBER PARTS			
	82-04	TORNILLO ESTABILIZADOR (7", 203.200 mm)	6102
		TORNILLO ESTABILIZADOR (7", 203.200 mm EQUIPO ORIGINAL)	6106
	83-04	BUJES PARA HORQUILLA SUPERIOR (4X4)	DAI-K-6283

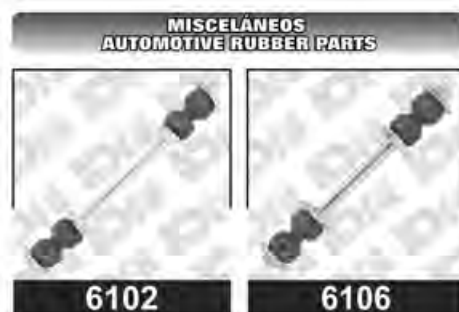

CONTINUACIÓN... BLAZER

 28	APLICACIÓN / DESCRIPTION	DAI PARTS #
MISCELÁNEOS / AUTOMOTIVE RUBBER PARTS		
88-94	BUJES PARA HORQUILLA SUPERIOR K-1500 (4X4)	DAI-K-6323
	BUJE PARA HORQUILLA SUPERIOR K1500 (4X4)	DAI-K-6395

C-10

SOPORTES / TRANSMISSION & MOTOR MOUNTS			
L6 4.1	63-80	SOPORTE PARA MOTOR IZQUIERDO Y DERECHO	1675
		SOPORTE PARA MOTOR IZQUIERDO Y DERECHO	1736
	63-81	SOPORTE PARA TRANSMISIÓN AUT., 3 VEL.	1577
		SOPORTE PARA TRANSMISIÓN TIPO UNIVERSAL	6800
	63-90	SOPORTE PARA TRANSMISIÓN	6774
	63-94	SOPORTE PARA TRANSMISIÓN (TORNILLOS SEPARADOS DE 68.5mm)	1734
		SOPORTE PARA TRANSMISIÓN (TORNILLOS JUNTOS DE 38.5mm)	1779
	66-82	SOPORTE PARA TRANSMISIÓN STD.	1704
	73-93	SOPORTE PARA MOTOR IZQUIERDO Y DERECHO	1782
	73-94	SOPORTE PARA TRANSMISIÓN (TORNILLOS JUNTOS DE 38.5mm)	1812



CONTINUACIÓN... C-10

			APLICACIÓN / DESCRIPTION	DAI PARTS #
SOPORTES / TRANSMISSION & MOTOR MOUNTS				
L6 4.1	73-94		SOPORTE PARA TRANSMISIÓN (TORNILLOS SEPARADOS DE 68.5mm)	1813
	82-99		SOPORTE PARA TRANSMISIÓN	1932
			SOPORTE PARA TRANSMISIÓN STD. Y AUT., 3 Y 4 VEL.	6766
	82-02		SOPORTE PARA TRANSMISIÓN STD. Y AUT., 3 Y 4 VEL. (4X4)	6874
	88-02		SOPORTE PARA MOTOR IZQUIERDO Y DERECHO	1920
L6 4.6	60-70		SOPORTE PARA MOTOR IZQUIERDO Y DERECHO	1920
L6 4.8	63-80		SOPORTE PARA MOTOR IZQUIERDO Y DERECHO	1675
	63-81		SOPORTE PARA TRANSMISIÓN AUT., 3 VEL.	1577
			SOPORTE PARA TRANSMISIÓN TIPO UNIVERSAL	6800
	66-82		SOPORTE PARA TRANSMISIÓN STD.	1704
	73-91		SOPORTE PARA MOTOR IZQUIERDO Y DERECHO	1769
	73-93		SOPORTE PARA MOTOR IZQUIERDO Y DERECHO	1782
	73-94		SOPORTE PARA TRANSMISIÓN (TORNILLOS SEPARADOS DE 38.5mm)	1812
			SOPORTE PARA TRANSMISIÓN (TORNILLOS SEPARADOS DE 68.5mm)	1813
			SOPORTE PARA TRANSMISIÓN (TORNILLOS SEPARADOS DE 68.5mm)	1734



CONTINUACIÓN... C-10

  28		APLICACIÓN / DESCRIPTION	DAI PARTS #	SOPORTES TRANSMISSION & MOTOR MOUNTS	
SOPORTES / TRANSMISSION & MOTOR MOUNTS					
L6 4.8	73-94	SOPORTE PARA TRANSMISIÓN (TORNILLOS JUNTOS DE 3/4")	1779		
	82-91	SOPORTE PARA TRANSMISIÓN	6774	1577	1704
	82-99	SOPORTE PARA TRANSMISIÓN	1932		
		SOPORTE PARA TRANSMISIÓN STD. Y AUT., 3 Y 4 VEL.	6766	1734	1779
	82-02	SOPORTE PARA TRANSMISIÓN STD. Y AUT., 3 Y 4 VEL. (4X4)	6874		
	88-02	SOPORTE PARA MOTOR IZQUIERDO Y DERECHO	1920	1782	1812
V6 3.8	84-86	SOPORTE PARA MOTOR DERECHO	6888		
		SOPORTE PARA MOTOR IZQUIERDO	6889	1813	1920
V8 5.0 V8 5.7 V8 6.2 V8 6.5	63-81	SOPORTE PARA TRANSMISIÓN AUT., 3 VEL.	1577		
	66-82	SOPORTE PARA TRANSMISIÓN STD.	1704		
	73-93	SOPORTE PARA MOTOR IZQUIERDO Y DERECHO	1782		
	73-94	SOPORTE PARA TRANSMISIÓN (TORNILLOS JUNTOS DE 38.5mm)	1812	1932	6766
		SOPORTE PARA TRANSMISIÓN (TORNILLOS SEPARADOS DE 68.5mm)	1813	6774	6874
		SOPORTE PARA TRANSMISIÓN (TORNILLOS JUNTOS DE 38.5mm)	1779	6888	6889
		SOPORTE PARA TRANSMISIÓN (TORNILLOS SEPARADOS DE 68.5mm)	1734		
82-91	SOPORTE PARA TRANSMISIÓN	6774			

CONTINUACIÓN... C-10

			APLICACIÓN / DESCRIPTION	DAI PARTS #
SOPORTES / TRANSMISSION & MOTOR MOUNTS				
V8 5.0 V8 5.7 V8 6.2 V8 6.5	82-92		SOPORTE PARA TRANSMISIÓN TIPO UNIVERSAL	6800
	82-99		SOPORTE PARA TRANSMISIÓN	1932
			SOPORTE PARA TRANSMISIÓN STD. Y AUT. 3 Y 4 VEL.	6766
	82-02		SOPORTE PARA TRANSMISIÓN STD. Y AUT., 3 Y 4 VEL. (4X4)	6874
	88-02		SOPORTE PARA MOTOR IZQUIERDO Y DERECHO	1920
V8 5.7 V8 6.6	73-91		SOPORTE PARA MOTOR IZQUIERDO Y DERECHO	1769
V8 6.6	73-91		SOPORTE PARA TRANSMISIÓN (TORNILLOS JUNTOS DE 38.5mm)	1779
			SOPORTE PARA TRANSMISIÓN (TORNILLOS JUNTOS DE 38.5mm)	1812



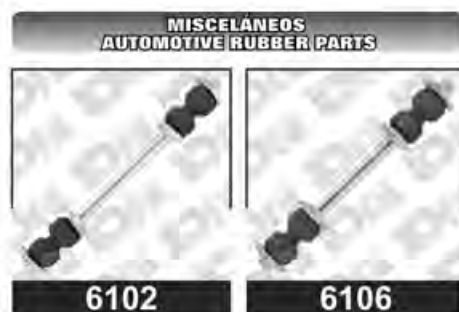

MISCELÁNEOS / AUTOMOTIVE RUBBER PARTS

	92-99	TORNILLO ESTABILIZADOR (7", 203.200 mm)	6102
		TORNILLO ESTABILIZADOR (7", 203.200 mm EQUIPO ORIGINAL)	6106
	1999	GOMA PARA BARRA ESTABILIZADORA	6406



C-15

 		APLICACIÓN / DESCRIPTION	DAI PARTS #
SOPORTES / TRANSMISSION & MOTOR MOUNTS			
L6 4.1	63-80	SOPORTE PARA MOTOR IZQUIERDO Y DERECHO	1736
	63-90	SOPORTE PARA TRANSMISIÓN	6774
	63-94	SOPORTE PARA TRANSMISIÓN (TORNILLOS SEPARADOS DE 68.5mm)	1734
L6 4.1	63-80	SOPORTE PARA MOTOR IZQUIERDO Y DERECHO	1675
L6 4.8	61-81	SOPORTE PARA TRANSMISIÓN TIPO UNIVERSAL	6800
L6 4.1 L6 4.8 V8 5.0 V8 5.7 V8 6.2 V8 6.5	63-81	SOPORTE PARA TRANSMISIÓN AUT., 3 VEL.	1577
	66-82	SOPORTE PARA TRANSMISIÓN STD.	1704
	73-93	SOPORTE PARA MOTOR IZQUIERDO Y DERECHO	1782
	73-94	SOPORTE PARA TRANSMISIÓN (TORNILLOS JUNTOS DE 38.5mm)	1812
		SOPORTE PARA TRANSMISIÓN (TORNILLOS SEPARADOS DE 68.5mm)	1813
	73-94	SOPORTE PARA TRANSMISIÓN (TORNILLOS SEPARADOS DE 68.5mm) (EXCEPTO MOTOR L6 4.1)	1734
		SOPORTE PARA TRANSMISIÓN (TORNILLOS JUNTOS DE 38.5mm)	1779
	82-91	SOPORTE PARA TRANSMISIÓN	6774
	82-92	SOPORTE PARA TRANSMISIÓN TIPO UNIVERSAL (EXCEPTO MOTOR L6 4.1 Y L6 4.8)	6800
	82-99	SOPORTE PARA TRANSMISIÓN	1932



CONTINUACIÓN... C-15

 		APLICACIÓN / DESCRIPTION	DAI PARTS #
SOPORTES / TRANSMISSION & MOTOR MOUNTS			
L6 4.1 L6 4.8	82-99	SOPORTE PARA TRANSMISIÓN STD. Y AUT., 3 Y 4 VEL.	6766
V8 5.0 V8 5.7	85-02	SOPORTE PARA TRANSMISIÓN STD. Y AUT., 3 Y 4 VEL. (4X4)	6874
V8 6.2 V8 6.5	88-02	SOPORTE PARA MOTOR IZQUIERDO Y DERECHO	1920



MISCELÁNEOS / AUTOMOTIVE RUBBER PARTS			
	78-08	COPLÉ PARA DIRECCIÓN HID. (SINFIN REBAJADO DE .810 mm 2 PERNOS DELGADOS)	606



C-20

SOPORTES / TRANSMISSION & MOTOR MOUNTS			
L6 4.1	63-80	SOPORTE PARA MOTOR IZQUIERDO Y DERECHO	1675
		SOPORTE PARA MOTOR IZQUIERDO Y DERECHO	1736



CONTINUACIÓN... C-20

	28	APLICACIÓN / DESCRIPTION	DAI PARTS #
--	----	--------------------------	-------------

**SOPORTES
TRANSMISSION & MOTOR MOUNTS**
SOPORTES / TRANSMISSION & MOTOR MOUNTS

L6 4.1	63-90	SOPORTE PARA TRANSMISIÓN	6774
	63-94	SOPORTE PARA TRANSMISIÓN (TORNILLOS SEPARADOS DE 68.5mm)	1734
		SOPORTE PARA TRANSMISIÓN (TORNILLOS JUNTOS DE 38.5mm)	1779

1675

1577

L6 4.1	63-81	SOPORTE PARA TRANSMISIÓN TIPO UNIVERSAL	6800
L6 4.8	82-02	SOPORTE PARA TRANSMISIÓN STD. Y AUT., 3 Y 4 VEL.	6874

1704

1734

L6 4.1 L6 4.8 V8 5.0 V8 5.7 V8 6.2 V8 6.5	63-81	SOPORTE PARA TRANSMISIÓN AUT., 3 VEL.	1577
	66-82	SOPORTE PARA TRANSMISIÓN STD.	1704
	73-94	SOPORTE PARA TRANSMISIÓN (TORNILLOS SEPARADOS DE 68.5mm) <i>(EXCEPTO L6 4.1)</i>	1734
		SOPORTE PARA MOTOR IZQUIERDO Y DERECHO	1782
		SOPORTE PARA TRANSMISIÓN (TORNILLOS JUNTOS DE 38.5mm) <i>(EXCEPTO L6 4.1)</i>	1779
		SOPORTE PARA TRANSMISIÓN (TORNILLOS JUNTOS DE 38.5mm)	1812
		SOPORTE PARA TRANSMISIÓN (TORNILLOS SEPARADOS DE 68.5mm)	1813
	82-91	SOPORTE PARA TRANSMISIÓN <i>(EXCEPTO L6 4.1)</i>	6774
		SOPORTE PARA TRANSMISIÓN TIPO UNIVERSAL	6800
	82-99	SOPORTE PARA TRANSMISIÓN	1932

1736

1779

1782

1812

1813

1932

6774

6800

6874

CONTINUACIÓN... C-20

  28		APLICACIÓN / DESCRIPTION	DAI PARTS #
SOPORTES / TRANSMISSION & MOTOR MOUNTS			
L6 4.1 L6 4.8	82-99	SOPORTE PARA TRANSMISIÓN STD. Y AUT., 3 Y 4 VEL.	6766
V8 5.0 V8 5.7	85-02	SOPORTE PARA TRANSMISIÓN STD. Y AUT., 3 Y 4 VEL. (4X4)	6874
V8 6.2 V8 6.5	88-02	SOPORTE PARA MOTOR IZQUIERDO Y DERECHO	1920



C-25

SOPORTES / TRANSMISSION & MOTOR MOUNTS			
V8 5.0	77-82	SOPORTE PARA TRANSMISIÓN	6774



C-30

SOPORTES / TRANSMISSION & MOTOR MOUNTS			
L6 4.1	63-80	SOPORTE PARA MOTOR IZQUIERDO Y DERECHO	1675
		SOPORTE PARA TRANSMISIÓN (TORNILLOS SEPARADOS DE 68.5mm)	1734



CONTINUACIÓN... C-30

  28		APLICACIÓN / DESCRIPTION	DAI PARTS #
SOPORTES / TRANSMISSION & MOTOR MOUNTS			
L6 4.1	63-80	SOPORTE PARA TRANSMISIÓN	6774
		SOPORTE PARA MOTOR IZQUIERDO Y DERECHO	1736
		SOPORTE PARA TRANSMISIÓN (TORNILLOS SEPARADOS DE 38.5mm)	1779
		SOPORTE PARA TRANSMISIÓN (TORNILLOS SEPARADOS DE 68.5mm)	1813
V8 5.7	73-93	SOPORTE PARA MOTOR IZQUIERDO Y DERECHO	1781
		SOPORTE PARA TRANSMISIÓN (TORNILLOS JUNTOS DE 38.5mm)	1812
		SOPORTE PARA MOTOR IZQUIERDO Y DERECHO	1709
	80-94	SOPORTE PARA MOTOR IZQUIERDO Y DERECHO	1782
		SOPORTE PARA TRANSMISIÓN (TORNILLOS SEPARADOS DE 68.5mm)	1813
V8 5.7 V8 6.5	88-99	SOPORTE PARA TRANSMISIÓN	6874

SOPORTES TRANSMISSION & MOTOR MOUNTS	
	
1709	1736
	
1779	1781
	
1782	1812

		
1813	6774	6874

MISCELÁNEOS / AUTOMOTIVE RUBBER PARTS		
78-08	COPLÉ PARA DIRECCIÓN HID. (SINFIN REBAJADO DE .810 mm 2 PERNOS DELGADOS)	606

MISCELÁNEOS AUTOMOTIVE RUBBER PARTS

606



C-35

			APLICACIÓN / DESCRIPTION	DAI PARTS #
SOPORTES / TRANSMISSION & MOTOR MOUNTS				
V8 5.7	73-93	SOPORTE PARA MOTOR IZQUIERDO Y DERECHO		1709
		SOPORTE PARA MOTOR IZQUIERDO Y DERECHO		1781
		SOPORTE PARA TRANSMISIÓN (TORNILLOS SEPARADOS DE 38.5mm)		1779
		SOPORTE PARA TRANSMISIÓN (TORNILLOS JUNTOS DE 38.5mm)		1812
	80-94	SOPORTE PARA MOTOR IZQUIERDO Y DERECHO		1782
		SOPORTE PARA TRANSMISIÓN (TORNILLOS SEPARADOS 68.5mm)		1734
SOPORTE PARA TRANSMISIÓN (TORNILLOS SEPARADOS DE 68.5mm)		1813		
V8 5.7 V8 6.5	88-99	SOPORTE PARA TRANSMISIÓN	6874	

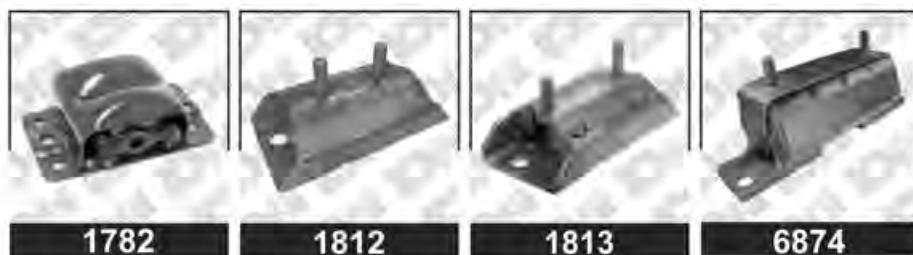

C-50

SOPORTES / TRANSMISSION & MOTOR MOUNTS				
V8 5.7	63-81	SOPORTE PARA TRANSMISIÓN (TORNILLOS SEPARADOS DE 38.5mm)		1779
		SOPORTE PARA TRANSMISIÓN (TORNILLOS JUNTOS DE 38.5mm)		1812



C-60

  28		APLICACIÓN / DESCRIPTION	DAI PARTS #
SOPORTES / TRANSMISSION & MOTOR MOUNTS			
V8 5.7	63-81	SOPORTE PARA TRANSMISIÓN (TORNILLOS SEPARADOS DE 38.5mm)	1779
		SOPORTE PARA TRANSMISIÓN (TORNILLOS JUNTOS DE 38.5mm)	1812



C-80

SOPORTES / TRANSMISSION & MOTOR MOUNTS			
5.2	66-72	SOPORTE PARA MOTOR CENTRAL	1150





C-85

SOPORTES / TRANSMISSION & MOTOR MOUNTS			
7.0	66-72	SOPORTE PARA MOTOR CENTRAL	1150



C-1500

 		APLICACIÓN / DESCRIPTION	DAI PARTS #
SOPORTES / TRANSMISSION & MOTOR MOUNTS			
L6 4.1 V8 5.0 V8 5.7 V8 6.2 V8 6.5	63-81	SOPORTE PARA TRANSMISIÓN AUT., 3 VEL.	1577
		SOPORTE PARA TRANSMISIÓN TIPO UNIVERSAL	6800
	66-82	SOPORTE PARA TRANSMISIÓN STD.	1704
	73-93	SOPORTE PARA MOTOR IZQUIERDO Y DERECHO	1782
	73-94	SOPORTE PARA TRANSMISIÓN (TORNILLOS SEPARADOS DE 68.5mm)	1734
		SOPORTE PARA TRANSMISIÓN (TORNILLOS JUNTOS DE 38.5mm)	1779
		SOPORTE PARA TRANSMISIÓN (TORNILLOS JUNTOS DE 38.5mm)	1812
		SOPORTE PARA TRANSMISIÓN (TORNILLOS SEPARADOS DE 68.5mm)	1813
	82-91	SOPORTE PARA TRANSMISIÓN	6774
	82-99	SOPORTE PARA TRANSMISIÓN	1932
		SOPORTE PARA TRANSMISIÓN STD. Y AUT., 3 Y 4 VEL.	6766
	82-02	SOPORTE PARA TRANSMISIÓN STD. Y AUT., 3 Y 4 VEL. (4X4)	6874
	88-02	SOPORTE PARA MOTOR IZQUIERDO Y DERECHO	1920

SOPORTES TRANSMISSION & MOTOR MOUNTS



1577 1704



1734 1779



1782 1812



1813 1920



1932 6766 6774 6800



6874



CONTINUACIÓN... C-1500



		APLICACIÓN / DESCRIPTION	DAI PARTS #
MISCELÁNEOS / AUTOMOTIVE RUBBER PARTS			
92-99		TORNILLO ESTABILIZADOR (7", 203.2 mm)	6102
		TORNILLO ESTABILIZADOR (7", 203.200 mm EQUIPO ORIGINAL)	6106
88-99		BUJES PARA HORQUILLA SUPERIOR	DAI-K-6323
		BUJE PARA HORQUILLA SUPERIOR	DAI-K-6395

C-2500

SOPORTES / TRANSMISSION & MOTOR MOUNTS			
L6 4.1 L6 4.8	63-81	SOPORTE PARA TRANSMISIÓN AUT., 3 VEL.	1577
		SOPORTE PARA TRANSMISIÓN TIPO UNIVERSAL	6800
	66-82	SOPORTE PARA TRANSMISIÓN STD.	1704
	73-93	SOPORTE PARA MOTOR IZQUIERDO Y DERECHO	1782
	73-94	SOPORTE PARA TRANSMISIÓN (TORNILLOS JUNTOS DE 38.5mm)	1812
		SOPORTE PARA TRANSMISIÓN (TORNILLOS SEPARADOS DE 68.5mm)	1813
	82-91	SOPORTE PARA TRANSMISIÓN	6774
	82-99	SOPORTE PARA TRANSMISIÓN	1932



CONTINUACIÓN... C-2500

 		APLICACIÓN / DESCRIPTION	DAI PARTS #
SOPORTES / TRANSMISSION & MOTOR MOUNTS			
L6 4.1 L6 4.8	82-99	SOPORTE PARA TRANSMISIÓN STD. Y AUT., 3 Y 4 VEL.	6766
	88-02	SOPORTE PARA TRANSMISIÓN STD. Y AUT. 3 Y 4 VEL. Y 4X4	6874
		SOPORTE PARA MOTOR IZQUIERDO Y DERECHO	1920
V8 5.0 V8 5.7 V8 6.2 V8 6.5	63-81	SOPORTE PARA TRANSMISIÓN AUT., 3 VEL.	1577
	66-82	SOPORTE PARA TRANSMISIÓN STD.	1704
	73-93	SOPORTE PARA MOTOR IZQUIERDO Y DERECHO	1782
	73-94	SOPORTE PARA TRANSMISIÓN (TORNILLOS JUNTOS DE 38.5mm)	1812
		SOPORTE PARA TRANSMISIÓN (TORNILLOS SEPARADOS DE 68.5mm)	1813
		SOPORTE PARA TRANSMISIÓN (TORNILLOS SEPARADOS DE 68.5mm)	1734
		SOPORTE PARA TRANSMISIÓN (TORNILLOS JUNTOS DE 38.5mm)	1779
	82-91	SOPORTE PARA TRANSMISIÓN	6774
	82-92	SOPORTE PARA TRANSMISIÓN TIPO UNIVERSAL	6800
	82-99	SOPORTE PARA TRANSMISIÓN	1932
		SOPORTE PARA TRANSMISIÓN STD. Y AUT., 3 Y 4 VEL.	6766
	88-02	SOPORTE PARA TRANSMISIÓN STD. Y AUT. 3 Y 4 VEL. Y 4X4	6874
		SOPORTE PARA MOTOR IZQUIERDO Y DERECHO	1920

**SOPORTES
TRANSMISSION & MOTOR MOUNTS**

	
1577	1704
	
1734	1779
	
1782	1812
	
1813	1920
	
1932	6766

		
6774	6800	6874



CONTINUACIÓN... C-2500

		APLICACIÓN / DESCRIPTION	DAI PARTS #
MISCELÁNEOS / AUTOMOTIVE RUBBER PARTS			
92-00		TORNILLO ESTABILIZADOR (7", 203.2 mm)	6102
		TORNILLO ESTABILIZADOR (7", 203.2 mm EQUIPO ORIGINAL)	6106
		BUJES PARA HORQUILLA SUPERIOR (8600 LBS.)	DAI-K-6323
		BUJE PARA HORQUILLA SUPERIOR (7200 LBS.)	DAI-K-6395

DAI-K-6323
DAI-K-6395
C-3500

SOPORTES / TRANSMISSION & MOTOR MOUNTS			
L6 4.1 L6 4.8	63-81	SOPORTE PARA TRANSMISIÓN AUT., 3 VEL.	1577
		SOPORTE PARA TRANSMISIÓN TIPO UNIVERSAL	6800
	66-82	SOPORTE PARA TRANSMISIÓN STD.	1704
	73-93	SOPORTE PARA MOTOR IZQUIERDO Y DERECHO	1782
	73-94	SOPORTE PARA TRANSMISIÓN (TORNILLOS JUNTOS DE 38.5mm)	1812
SOPORTE PARA TRANSMISIÓN (TORNILLOS SEPARADOS DE 68.5mm)		1813	

1782
1812
1813
6800

CONTINUACIÓN... C-3500

		APLICACIÓN / DESCRIPTION	DAI PARTS #
---	---	---------------------------------	--------------------

**SOPORTES
TRANSMISSION & MOTOR MOUNTS**

SOPORTES / TRANSMISSION & MOTOR MOUNTS

L6 4.1 L6 4.8	73-94	SOPORTE PARA TRANSMISIÓN (TORNILLOS SEPARADOS DE 68.5mm)	1734
		SOPORTE PARA TRANSMISIÓN (TORNILLOS JUNTOS DE 38.5mm)	1779
	82-91	SOPORTE PARA TRANSMISIÓN	6774
	82-99	SOPORTE PARA TRANSMISIÓN	1932
		SOPORTE PARA TRANSMISIÓN STD. Y AUT., 3 Y 4 VEL. (4X4)	6766
	82-02	SOPORTE PARA TRANSMISIÓN STD. Y AUT., 3 Y 4 VEL. (4X4)	6874
88-02	SOPORTE PARA MOTOR IZQUIERDO Y DERECHO	1920	



1577 1704

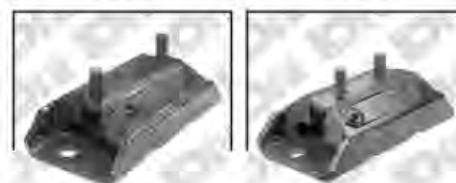

1734 1779

V8 5.0 V8 5.7 V8 6.2 V8 6.5	63-81	SOPORTE PARA TRANSMISIÓN AUT., 3 VEL.	1577
	66-82	SOPORTE PARA TRANSMISIÓN STD.	1704
	73-93	SOPORTE PARA MOTOR IZQUIERDO Y DERECHO	1782
	73-94	SOPORTE PARA TRANSMISIÓN (TORNILLOS JUNTOS DE 38.5mm)	1812
		SOPORTE PARA TRANSMISIÓN (TORNILLOS SEPARADOS DE 68.5mm)	1813
	82-91	SOPORTE PARA TRANSMISIÓN	6774
	82-92	SOPORTE PARA TRANSMISIÓN TIPO UNIVERSAL	6800
	82-99	SOPORTE PARA TRANSMISIÓN	1932
		SOPORTE PARA TRANSMISIÓN STD. Y AUT., 3 Y 4 VEL.	6766
	82-02	SOPORTE PARA TRANSMISIÓN STD. Y AUT., 3 Y 4 VEL. (4X4)	6874



1782 1812



1813 1920



1932 6766



6774 6800 6874



CONTINUACIÓN... C-3500

 		APLICACIÓN / DESCRIPTION	DAI PARTS #
SOPORTES / TRANSMISSION & MOTOR MOUNTS			
V8 5.0 V8 5.7 V8 6.2 V8 6.5	88-02	SOPORTE PARA MOTOR IZQUIERDO Y DERECHO	1920
V8 5.7	73-07	SOPORTE PARA TRANSMISIÓN (TORNILLOS JUNTOS DE 38.5mm)	1812
	82-07	SOPORTE PARA TRANSMISIÓN STD. Y AUT.	6874
V8 5.8	01-07	SOPORTE PARA MOTOR IZQUIERDO Y DERECHO	7391
V8 8.1	02-07	SOPORTE PARA MOTOR IZQUIERDO Y DERECHO (HEVY DUTY)	7128
	01-07	SOPORTE PARA BARRA DE TORSIÓN	7548

**SOPORTES
TRANSMISSION & MOTOR MOUNTS**

1812

1920

6874

7128

7391

7548
MISCELÁNEOS / AUTOMOTIVE RUBBER PARTS

88-00	BUJE PARA HORQUILLA SUPERIOR (SUSPENSIÓN INDEPENDIENTE)	DAI-K-6395
-------	--	------------

**MISCELÁNEOS
AUTOMOTIVE RUBBER PARTS**

DAI-K-6395

C-4500

 		APLICACIÓN / DESCRIPTION	DAI PARTS #
SOPORTES / TRANSMISSION & MOTOR MOUNTS			
V8 8.1	02-05	SOPORTE PARA MOTOR IZQUIERDO Y DERECHO (HEAVY DUTY)	7128



CAMARO

SOPORTES / TRANSMISSION & MOTOR MOUNTS			
L4 2.5	82-86	SOPORTE PARA TRANSMISIÓN STD. Y AUT.	6766
		SOPORTE PARA TRANSMISIÓN STD., 5 VEL.	6774
		SOPORTE PARA MOTOR IZQUIERDO	6909
		SOPORTE PARA MOTOR DERECHO	6983
V6 2.8	82-92	SOPORTE PARA MOTOR IZQUIERDO Y DERECHO	6888
		SOPORTE PARA TRANSMISIÓN	6792
V6 3.1	90-92	SOPORTE PARA MOTOR IZQUIERDO Y DERECHO	6888
		SOPORTE PARA TRANSMISIÓN	6792
V6 3.4	93-95	SOPORTE PARA MOTOR IZQUIERDO Y DERECHO	6888
	93-02	SOPORTE PARA TRANSMISIÓN	7469-H
V6 3.6	10-13	SOPORTE PARA TRANSMISIÓN AUT.	7515



CONTINUACIÓN... CAMARO

 		APLICACIÓN / DESCRIPTION	DAI PARTS #
MISCELÁNEOS / AUTOMOTIVE RUBBER PARTS			
V6 3.8	80-81	SOPORTE PARA TRANSMISIÓN	6770
		SOPORTE PARA TRANSMISIÓN TIPO UNIVERSAL	6800
	81-02	SOPORTE PARA MOTOR IZQUIERDO Y DERECHO	6888
	95-02	SOPORTE PARA TRANSMISIÓN	7469-H
V8 5.7	98-02	SOPORTE PARA TRANSMISIÓN	7513



MISCELÁNEOS / AUTOMOTIVE RUBBER PARTS		
10-12	TOPE PARA AMORTIGUADOR FRONTAL Y TRASERO IZQ. Y DER.	D-0621

CAMARO Z28

	APLICACIÓN / DESCRIPTION	DAI PARTS #	DAI KIT PARTS #
BASES PARA AMORTIGUADOR / STRUT MOUNTS			
82-92	BASE PARA AMORTIGUADOR FRONTAL DERECHA	6727	6727-KIT



CONTINUACIÓN... CAMARO Z28







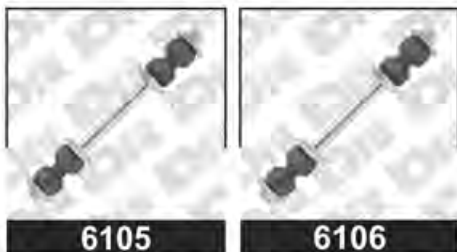
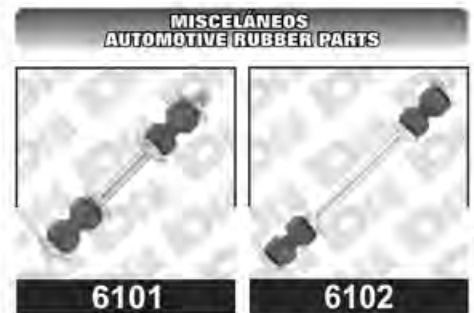



28	APLICACIÓN / DESCRIPTION	DAI PARTS #	DAI KIT PARTS #
BASES PARA AMORTIGUADOR / STRUT MOUNTS			
82-92	BASE PARA AMORTIGUADOR FRONTAL IZQUIERDA	6728	6728-KIT
93-02	BASE DE AMORTIGUADOR FRONTAL DERECHA	6751	6751-KIT
	BASE DE AMORTIGUADOR FRONTAL IZQUIERDA	6761	6761-KIT



28	APLICACIÓN / DESCRIPTION	DAI PARTS #
MISCELÁNEOS / AUTOMOTIVE RUBBER PARTS		
67-92	TORNILLO ESTABILIZADOR (7", 203.2 mm)	6102
	TORNILLO ESTABILIZADOR (7", 203.2 mm EQUIPO ORIGINAL)	6106
93-02	TORNILLO ESTABILIZADOR (6", 177.8 mm)	6101
	TORNILLO ESTABILIZADOR (6", 177.8 mm EQUIPO ORIGINAL)	6105



CAMIONETAS

 		APLICACIÓN / DESCRIPTION	DAI PARTS #	SOPORTES TRANSMISSION & MOTOR MOUNTS	
L6 3.8	54-81	SOPORTE PARA MOTOR INFERIOR IZQUIERDO Y DERECHO (1/2 A 3 TONELADAS)	1418		
		SOPORTE PARA TRANSMISIÓN AUT. 3 VEL.	1577		
		SOPORTE PARA MOTOR SUPERIOR IZQUIERDO Y DERECHO (2 A 3 TONELADAS)	1723		
		SOPORTE PARA MOTOR TRASERO SUPERIOR IZQUIERDO Y DERECHO (1/2 A 3 TONELADAS)	1417		
	55-62	SOPORTE PARA MOTOR FRONTAL IZQUIERDO Y DERECHO (3/4 A 1 TONELADA)	1467		
L6 4.7	56-90	SOPORTE PARA MOTOR SUPERIOR IZQUIERDO Y DERECHO (1/2 A 2 TONELADAS)	1630		
		SOPORTE PARA MOTOR INFERIOR IZQUIERDO Y DERECHO (1/2 A 2 TONELADAS)	1631		
V8 5.6	54-81	SOPORTE PARA MOTOR TRASERO SUPERIOR IZQUIERDO Y DERECHO (1/2 A 3 TONELADAS)	1417		
		SOPORTE PARA MOTOR INFERIOR IZQUIERDO Y DERECHO (1/2 A 3 TONELADAS)	1418		
		SOPORTE PARA TRANSMISIÓN	1577		
V8 5.7	54-81	SOPORTE PARA MOTOR INFERIOR IZQUIERDO Y DERECHO (1/2 A 3 TONELADAS)	1418		
		SOPORTE PARA TRANSMISIÓN	1577		
		SOPORTE PARA MOTOR SUPERIOR IZQUIERDO Y DERECHO (2 A 3 TONELADAS)	1723		
	56-90	SOPORTE PARA MOTOR INFERIOR IZQUIERDO Y DERECHO (1/2 A 2 TONELADAS)	1631		

CONTINUACIÓN... CAMIONETAS

 		APLICACIÓN / DESCRIPTION	DAI PARTS #
SOPORTES / TRANSMISSION & MOTOR MOUNTS			
V8 5.7	56-90	SOPORTE PARA MOTOR SUPERIOR IZQUIERDO Y DERECHO (1/2" A 2 TONELADAS)	1630
V8 5.7 V8 6.6	64-89	SOPORTE PARA TRANSMISIÓN (TIPO UNIVERSAL)	6800



MISCELÁNEOS / AUTOMOTIVE RUBBER PARTS		
	CONJUNTO DE GOMAS TRASERAS PARA CASETA	102
	GOMA TRASERA PARA CASETA	107
	GOMA TRASERA PARA CASETA	108
	GOMA PARA BARRA ESTABILIZADORA (CON ABRAZADERA)	1887
	GOMA PARA BARRA ESTABILIZADORA (SIN ABRAZADERA)	1887-9
	BUJE PARA MUELLE (1 1/12" X 1/2" X 2" 3/4") (POLIURETANO)	9094
	GOMA PARA BARRA ESTABILIZADORA (POLIURETANO)	9087



CAMIONETAS 3/4 A 1 TONELADA

		APLICACIÓN / DESCRIPTION	DAI PARTS #
SOPORTES / TRANSMISSION & MOTOR MOUNTS			
L6 3.8	55-62	SOPORTE PARA MOTOR DELANTERO IZQUIERDO Y DERECHO	1467

**SOPORTES
TRANSMISSION & MOTOR MOUNTS**

1467
CANYON

SOPORTES / TRANSMISSION & MOTOR MOUNTS			
L4 2.9	05-11	SOPORTE PARA TRASNSMISIÓN (4X4)	6874
V6 3.7	05-12	SOPORTE PARA TRASNSMISIÓN (4X4)	6874

**SOPORTES
TRANSMISSION & MOTOR MOUNTS**

6874
CAPRICE

SOPORTES / TRANSMISSION & MOTOR MOUNTS			
L6 4.1	67-35	SOPORTE PARA MOTOR IZQUIERDO Y DERECHO	1675
L6 4.1	63-75	SOPORTE PARA TRANSMISIÓN STD. Y AUT.	1704
L6 4.8			
L6 4.8	79-82	SOPORTE PARA MOTOR IZQUIERDO Y DERECHO	1782
L6 5.0			
L6 5.7		SOPORTE PARA TRANSMISIÓN STD. Y AUT.	1757

**SOPORTES
TRANSMISSION & MOTOR MOUNTS**

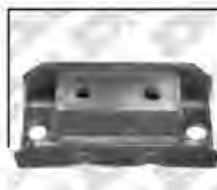
1675

1704

1757

1782



CONTINUACIÓN... CAPRICE

 		APLICACIÓN / DESCRIPTION	DAI PARTS #
SOPORTES / TRANSMISSION & MOTOR MOUNTS			
V6 2.8 V6 3.1 V6 4.3	82-96	SOPORTE PARA TRANSMISIÓN	6792
V6 3.2 V6 3.8 V6 4.1 V6 4.3	78-88	SOPORTE PARA TRANSMISIÓN	6770
V6 3.7	80-84	SOPORTE PARA MOTOR IZQUIERDO	6889
		SOPORTE PARA MOTOR DERECHO	6888

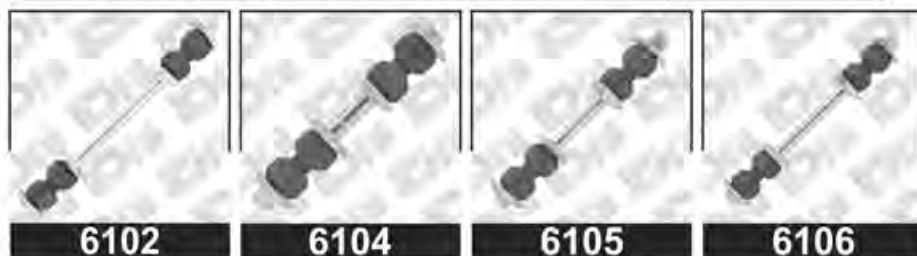
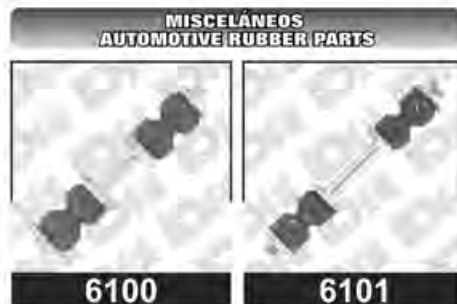

MISCELÁNEOS / AUTOMOTIVE RUBBER PARTS

58-70	TORNILLO ESTABILIZADOR (5", 154.4 mm)	6100
49-57	TORNILLO ESTABILIZADOR (6", 177.8 mm)	6101
71-96	TORNILLO ESTABILIZADOR (7", 203.2 mm)	6102
58-70	TORNILLO ESTABILIZADOR (5", 154.24 mm EQUIPO ORIGINAL)	6104
49-57	TORNILLO ESTABILIZADOR (6", 177.8 mm EQUIPO ORIGINAL)	6105
71-96	TORNILLO ESTABILIZADOR (7", 203.2 mm EQUIPO ORIGINAL)	6106



CAPTIVA

 		APLICACIÓN / DESCRIPTION	DAI PARTS #
SOPORTES / TRANSMISSION & MOTOR MOUNTS			
L4 2.4	11-16	SOPORTE PARA MOTOR FRONTAL	7692
	12-14	SOPORTE PARA MOTOR DERECHO	7541-H
V6 3.0	10-15	SOPORTE PARA MOTOR DERECHO	7541-H
	10-16	SOPORTE PARA MOTOR FRONTAL	7691
V6 3.6	13-14	SOPORTE PARA MOTOR DERECHO	7541-H

**SOPORTES
TRANSMISSION & MOTOR MOUNTS**

7541-H

7691

7692
CAVALIER

SOPORTES / TRANSMISSION & MOTOR MOUNTS			
L4 1.8	82-84	SOPORTE PARA MOTOR DERECHO	6777
	82-89	SOPORTE PARA MOTOR TRASERO	1909
		SOPORTE PARA MOTOR TRASERO	1980
		SOPORTE PARA MOTOR TRASERO DERECHO	6638
		REPUESTO PARA SOPORTE DE TRANSMISIÓN (6655)	6642
		SOPORTE PARA MOTOR TRASERO	6647
		SOPORTE PARA TRANSMISIÓN	6655

**SOPORTES
TRANSMISSION & MOTOR MOUNTS**

1909

1980

6638

6642

6647

6655

6777

CONTINUACIÓN... CAVALIER

			APLICACIÓN / DESCRIPTION	DAI PARTS #
SOPORTES / TRANSMISSION & MOTOR MOUNTS				
L4 2.0	85-89	SOPORTE PARA MOTOR TRASERO	1909	
		SOPORTE PARA MOTOR FRONTAL DERECHO	1971	
		SOPORTE PARA MOTOR FRONTAL DERECHO	1972	
		SOPORTE PARA MOTOR TRASERO	1980	
		SOPORTE PARA MOTOR TRASERO DERECHO	6638	
		SOPORTE PARA MOTOR TRASERO	6647	
		REPUESTO PARA SOPORTE DE TRANSMISIÓN (6655)	6642	
		SOPORTE PARA TRANSMISIÓN	6655	
L4 2.2	90-94	SOPORTE PARA MOTOR TRASERO	1909	
		SOPORTE PARA MOTOR FRONTAL DERECHO	1971	
		SOPORTE PARA MOTOR FRONTAL DERECHO	1972	
		SOPORTE PARA MOTOR TRASERO	1980	
		SOPORTE PARA MOTOR TRASERO DERECHO	6638	
		REPUESTO PARA SOPORTE DE TRANSMISIÓN (6655)	6642	
	SOPORTE PARA TRANSMISIÓN	6655		
02-05	SOPORTE PARA MOTOR DERECHO	7278-H		
L4 2.2 L4 2.3 L4 2.4	95-05	REPUESTO PARA SOPORTE MOTOR DERECHO	6837-9	
REPUESTO PARA SOPORTE MOTOR DERECHO		6837-H		
SOPORTE PARA TRANSMISIÓN AUT.		6843		
SOPORTE PARA MOTOR FRONTAL DERECHO INFERIOR (BUJE CORTO 44.84 mm)		6853		

**SOPORTES
TRANSMISSION & MOTOR MOUNTS**

	
1909	1971
	
1972	1980
	
6638	6642
	
6647	6655
	
6837-H	6837-9

		
6843	6853	7278-H



CONTINUACIÓN... CAVALIER

		APLICACIÓN / DESCRIPTION	DAI PARTS #
SOPORTES / TRANSMISSION & MOTOR MOUNTS			
L4 2.2 L4 2.3 L4 2.4	95-05	REPUESTO PARA SOPORTE DE TRANSMISIÓN FRONTAL STD., 5 VEL.	7200
		REPUESTO PARA SOPORTE PARA TRANSMISIÓN TRASERO STD., 5 VEL.	7312
V6 2.8 V6 3.1	85-95	SOPORTE PARA MOTOR FRONTAL DERECHO	1971
		SOPORTE PARA MOTOR FRONTAL DERECHO	1972
		SOPORTE PARA MOTOR TRASERO	1909
		SOPORTE PARA MOTOR TRASERO DERECHO	6638
		SOPORTE PARA MOTOR TRASERO	6647
		REPUESTO PARA SOPORTE DE TRANSMISIÓN (6655)	6642
SOPORTE PARA TRANSMISIÓN	6655		

**SOPORTES
TRANSMISSION & MOTOR MOUNTS**

1909

1971

1972

6638

6642

6647

6655

7200

7312

	APLICACIÓN / DESCRIPTION	DAI PARTS #	DAI KIT PARTS #
BASES PARA AMORTIGUADOR / STRUT MOUNTS			
82-91	BASE PARA AMORTIGUADOR FRONTAL IZQUIERDA Y DERECHA	6711	6711-KIT
84-94	BASE PARA AMORTIGUADOR TRASERA IZQUIERDA Y DERECHA	1821	1821-KIT

**BASES PARA AMORTIGUADOR
STRUT MOUNTS**

1821

1821-KIT

6711

6711-KIT

CONTINUACIÓN... CAVALIER

 		APLICACIÓN / DESCRIPTION	DAI PARTS #
MISCELÁNEOS / AUTOMOTIVE RUBBER PARTS			
82-94		GOMA PARA BARRA ESTABILIZADORA	6402
		GOMA PARA BARRA ESTABILIZADORA	6403
95-05		GOMA PARA BARRA ESTABILIZADORA	6404
		GOMA SUJETADORA DE ESCAPE	6562
99-05		GOMA PARA BARRA ESTABILIZADORA 7/8"	64707



CAVALIER Z24

SOPORTES / TRANSMISSION & MOTOR MOUNTS			
L4 2.2	95-04	REPUESTO PARA SOPORTE MOTOR DERECHO	6974
V6 2.8 V6 3.1	91-96	SOPORTE TORSIÓN TRASERO	1909
		SOPORTE PARA MOTOR FRONTAL DERECHO	1971
		SOPORTE PARA MOTOR FRONTAL DERECHO	1972
		SOPORTE PARA MOTOR TRASERO DERECHO	6638
		SOPORTE PARA MOTOR TRASERO	6647
		SOPORTE PARA TRANSMISIÓN	6655
		REPUESTO PARA SOPORTE DE TRANSMISIÓN (6655)	6642



CONTINUACIÓN... CAVALIER Z24

 28	APLICACIÓN / DESCRIPTION	DAI PARTS #	DAI KIT PARTS #
BASES PARA AMORTIGUADOR / STRUT MOUNTS			
82-94	BASE PARA AMORTIGUADOR TRASERA IZQUIERDA Y DERECHA	1821	1821-KIT
	BASE PARA AMORTIGUADOR FRONTAL IZQUIERDA Y DERECHA	6711	6711-KIT
95-99	BASE PARA AMORTIGUADOR FRONTAL IZQUIERDA Y DERECHA	6731	6731-KIT
95-05	BASE PARA AMORTIGUADOR TRASERA IZQUIERDA Y DERECHA	6752	6752-KIT
00-05	BASE PARA AMORTIGUADOR FRONTAL IZQUIERDA Y DERECHA		6986-KIT

**BASES PARA AMORTIGUADOR
STRUT MOUNTS**

1821

1821-KIT

6711

6711-KIT

6731

6731-KIT

6752

6752-KIT

6986-KIT



 28	APLICACIÓN / DESCRIPTION	DAI PARTS #
CUBRE POLVOS / C.V. BOOTS		
95-05	CUBRE POLVO IZQUIERDO Y DERECHO LADO RUEDA	6378
	CUBRE POLVO IZQUIERDO Y DERECHO LADO CAJA	6380

**CUBRE POLVO
C.V. BOOTS**

6378

6380

CONTINUACIÓN... CAVALIER Z24



		APLICACIÓN / DESCRIPTION	DAI PARTS #
CUBRE POLVOS / C.V. BOOTS			
	95-05	CUBRE POLVO IZQUIERDO Y DERECHO LADO CAJA (MANUAL)	6391

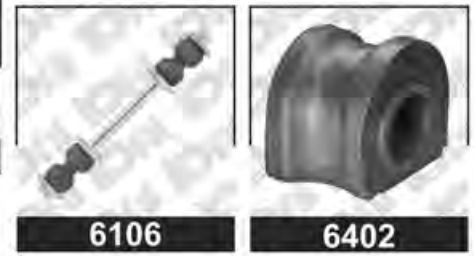
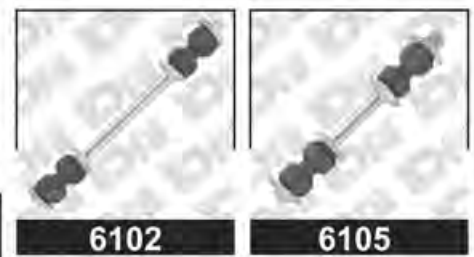
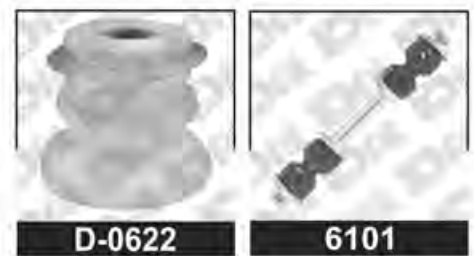

MISCELÁNEOS / AUTOMOTIVE RUBBER PARTS			
82-94	TORNILLO ESTABILIZADOR (6", 177.8 mm)	6101	
	TORNILLO ESTABILIZADOR (7", 203.2 mm)	6102	
	TORNILLO ESTABILIZADOR (6", 177.8 mm EQUIPO ORIGINAL)	6105	
	TORNILLO ESTABILIZADOR (7", 203.2 mm EQUIPO ORIGINAL)	6106	
	GOMA PARA BARRA ESTABILIZADORA	6402	
	GOMA PARA BARRA ESTABILIZADORA	6403	
92-94	TOPE PARA AMORTIGUADOR FRONTAL IZQUIERDO Y DERECHO	D-0620	
95-05	TOPE PARA AMORTIGUADOR FRONTAL IZQUIERDO Y DERECHO	D-0619	
	TOPE PARA AMORTIGUADOR FRONTAL IZQUIERDO Y DERECHO	D-0622	
	GOMA PARA BARRA ESTABILIZADORA	6404	
	GOMA SUJETADORA DE ESCAPE	6562	
	GOMA PARA BARRA ESTABILIZADORA 5/8"	64697	



CONTINUACIÓN... CAVALIER Z24



		APLICACIÓN / DESCRIPTION	DAI PARTS #
MISCELÁNEOS / AUTOMOTIVE RUBBER PARTS			
95-05		GOMA PARA BARRA ESTABILIZADORA 7/8"	64707
		BUJES PARA HORQUILLA	DAI-K-6578

CELEBRITY



SOPORTES / TRANSMISSION & MOTOR MOUNTS			
L4 2.5	82-88	SOPORTE PARA MOTOR DERECHO	1814
	82-95	SOPORTE PARA TRANSMISIÓN TRASERO IZQUIERDO	1837
		SOPORTE PARA TRANSMISIÓN TRASERO IZQUIERDO	1838
		SOPORTE PARA TRANSMISIÓN FRONTAL IZQUIERDO	1839
		SOPORTE DE TORSIÓN FRONTAL SUPERIOR	1864
		SOPORTE PARA MOTOR DERECHO	1970
		SOPORTE PARA MOTOR DERECHO	6633-H
V6 2.8 V6 3.1	82-95	SOPORTE PARA TRANSMISIÓN TRASERO IZQUIERDO	1837
		SOPORTE PARA TRANSMISIÓN TRASERO IZQUIERDO	1838
		SOPORTE PARA TRANSMISIÓN FRONTAL IZQUIERDO	1839
		SOPORTE DE TORSIÓN FRONTAL SUPERIOR	1864
		SOPORTE PARA MOTOR DERECHO	1970
		SOPORTE PARA MOTOR DERECHO	6633-H



CONTINUACIÓN... CELEBRITY



		APLICACIÓN / DESCRIPTION	DAI PARTS #
BASES PARA AMORTIGUADOR / STRUT MOUNTS			
82-96		BASE PARA AMORTIGUADOR TRASERA IZQUIERDA Y DERECHA	1821 1821-KIT
		BASE PARA AMORTIGUADOR FRONTAL IZQUIERDA Y DERECHA	6666 6666-KIT
		BASE PARA AMORTIGUADOR FRONTAL IZQUIERDA Y DERECHA	6667 6667-KIT



		APLICACIÓN / DESCRIPTION	DAI PARTS #
CUBRE POLVOS / C.V. BOOTS			
82-96		CUBRE POLVO IZQUIERDO Y DERECHO LADO RUEDA	6304
		CUBRE POLVO IZQUIERDO Y DERECHO LADO CAJA	6330
		CUBRE POLVO IZQUIERDO Y DERECHO LADO RUEDA	6351
		CUBRE POLVO IZQUIERDO Y DERECHO LADO CAJA (IMPORTACIÓN)	6357
		CUBRE POLVO IZQUIERDO Y DERECHO LADO CAJA	6358
		CUBRE POLVO IZQUIERDO Y DERECHO DE DIRECCIÓN STD.	6367



CONTINUACIÓN... CELEBRITY

 		APLICACIÓN / DESCRIPTION	DAI PARTS #
CUBRE POLVOS / C.V. BOOTS			
82-96		CUBRE POLVO IZQUIERDO Y DERECHO DE DIRECCIÓN HID.	6368
		CUBRE POLVO DERECHO LADO CAJA (MANUAL)	6375
		CUBRE POLVO IZQUIERDO Y DERECHO LADO CAJA (IMPORTACIÓN CON TRIPOIDE)	6387
		CUBRE POLVO IZQUIERDO Y DERECHO LADO CAJA	6393

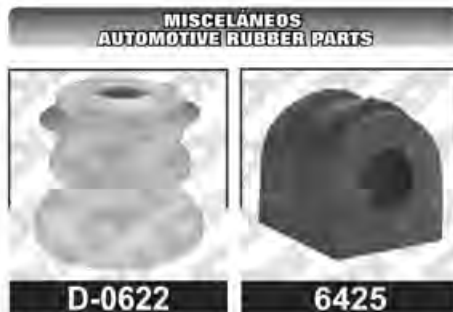

MISCELÁNEOS / AUTOMOTIVE RUBBER PARTS			
82-96		GOMA PARA BARRA ESTABILIZADORA	6425
		TOPE PARA AMORTIGUADOR FRONTAL IZQUIERDO Y DERECHO	D-0622

CENTURY

MISCELÁNEOS / AUTOMOTIVE RUBBER PARTS			
L4 2.2	93-94	SOPORTE DE TORSIÓN FRONTAL SUPERIOR	6781
	93-96	SOPORTE PARA MOTOR DERECHO	1970



CONTINUACIÓN... CENTURY

			APLICACIÓN / DESCRIPTION	DAI PARTS #
SOPORTES / TRANSMISSION & MOTOR MOUNTS				
L4 2.2	93-96	SOPORTE PARA MOTOR DERECHO		6633-H
	95-96	SOPORTE DE TORSIÓN FRONTAL SUPERIOR (15.5 mm)		7172
		REPUESTO PARA SOPORTE DE TORSIÓN FRONTAL SUPERIOR IZQUIERDO Y DERECHO (7172)		7172-9
L4 2.5	82-84	SOPORTE PARA MOTOR DERECHO		1814
		SOPORTE PARA TRANSMISIÓN FRONTAL IZQUIERDO		1839
		SOPORTE PARA TRANSMISIÓN TRASERO IZQUIERDO		1837
		SOPORTE PARA TRANSMISIÓN TRASERO IZQUIERDO		1838
	85-92	SOPORTE PARA MOTOR DERECHO		1970
		SOPORTE PARA MOTOR DERECHO		6633-H
	82-92	SOPORTE DE TORSIÓN FRONTAL SUPERIOR		1864
V6 2.8	83-85	SOPORTE DE TORSIÓN FRONTAL SUPERIOR		6778
	83-95	SOPORTE PARA MOTOR DERECHO		1814
		SOPORTE PARA TRANSMISIÓN FRONTAL IZQUIERDO		1839
		SOPORTE PARA TRANSMISIÓN TRASERO IZQUIERDO		1837
		SOPORTE PARA TRANSMISIÓN TRASERO IZQUIERDO		1838
	85-95	SOPORTE PARA MOTOR DERECHO		1970
		SOPORTE PARA MOTOR DERECHO		6633-H
	86-95	SOPORTE DE TORSIÓN FRONTAL SUPERIOR		1864



CONTINUACIÓN.. CENTURY

		APLICACIÓN / DESCRIPTION	DAI PARTS #	SOPORTES TRANSMISSION & MOTOR MOUNTS	
SOPORTES / TRANSMISSION & MOTOR MOUNTS					
V6 3.0	82-84	SOPORTE PARA MOTOR DERECHO	1814		
	1985	SOPORTE PARA MOTOR DERECHO	1970		
		SOPORTE PARA MOTOR DERECHO	6633-H		
	82-85	SOPORTE DE TORSIÓN FRONTAL SUPERIOR	6778		
		SOPORTE PARA TRANSMISIÓN FRONTAL IZQUIERDO	1839		
		SOPORTE PARA TRANSMISIÓN TRASERO IZQUIERDO	1837		
	SOPORTE PARA TRANSMISIÓN TRASERO IZQUIERDO	1838			
V6 3.1	1994	SOPORTE DE TORSIÓN FRONTAL SUPERIOR	1864		
	94-96	SOPORTE PARA TRANSMISIÓN TRASERO IZQUIERDO	1837		
		SOPORTE PARA TRANSMISIÓN TRASERO IZQUIERDO	1838		
		SOPORTE PARA TRANSMISIÓN FRONTAL IZQUIERDO	1839		
		SOPORTE PARA MOTOR DERECHO	1970		
		SOPORTE PARA MOTOR DERECHO	6633-H		
	95-05	SOPORTE DE TORSIÓN FRONTAL SUPERIOR (15.5 mm)	7172		
		REPUESTO PARA SOPORTE DE TORSIÓN FRONTAL SUPERIOR IZQUIERDO Y DERECHO (7172)	7172-9		
	97-05	SOPORTE PARA MOTOR DERECHO	6838-H		
6838-H	6844	6875-H	7166	7172	7172-9



CONTINUACIÓN.. CENTURY

 		APLICACIÓN / DESCRIPTION	DAI PARTS #
SOPORTES / TRANSMISSION & MOTOR MOUNTS			
V6 3.3	89-93	SOPORTE DE TORSIÓN FRONTAL SUPERIOR	1864
		SOPORTE PARA TRANSMISIÓN TRASERO IZQUIERDO	1837
		SOPORTE PARA TRANSMISIÓN TRASERO IZQUIERDO	1838
		SOPORTE PARA TRANSMISIÓN FRONTAL IZQUIERDO	1839
		SOPORTE PARA MOTOR DERECHO	1970
		SOPORTE PARA MOTOR DERECHO	6633-H
V6 3.8	75-77	SOPORTE PARA MOTOR IZQUIERDO	6790
		SOPORTE PARA TRANSMISIÓN TIPO UNIVERSAL	6800
	75-81	SOPORTE PARA MOTOR DERECHO	6791
		SOPORTE PARA TRANSMISIÓN	6770
	82-84	SOPORTE PARA MOTOR DERECHO	1814
	84-88	SOPORTE PARA TRANSMISIÓN FRONTAL IZQUIERDO	1839
		SOPORTE PARA TRANSMISIÓN TRASERO IZQUIERDO	1837
		SOPORTE PARA TRANSMISIÓN TRASERO IZQUIERDO	1838
	84-86	SOPORTE DE TORSIÓN FRONTAL SUPERIOR	6778
	85-88	SOPORTE PARA MOTOR DERECHO	1970
		SOPORTE PARA MOTOR DERECHO	6633-H
	87-88	SOPORTE DE TORSIÓN FRONTAL SUPERIOR	1864



IMPORTANTE: Identifica nuestro producto con el grabado del logo  No aceptes imitaciones.



CONTINUACIÓN... CENTURY

APLICACIÓN / DESCRIPTION		DAI PARTS #	DAI KIT PARTS #
BASES PARA AMORTIGUADOR / STRUT MOUNTS			
82-96	BASE PARA AMORTIGUADOR TRASERA IZQUIERDA Y DERECHA	1821	1821-KIT
	BASE PARA AMORTIGUADOR FRONTAL IZQUIERDA Y DERECHA	6666	6666-KIT
	BASE PARA AMORTIGUADOR FRONTAL IZQUIERDA Y DERECHA	6667	6667-KIT
97-05	BASE PARA AMORTIGUADOR FRONTAL IZQUIERDA Y DERECHA		7222-KIT



6666 **6666-KIT**

APLICACIÓN / DESCRIPTION		DAI PARTS #
CUBRE POLVOS / C.V. BOOTS		
82-96	CUBRE POLVO IZQUIERDO Y DERECHO LADO RUEDA	6304
	CUBRE POLVO IZQUIERDO Y DERECHO LADO CAJA	6330
	CUBRE POLVO IZQUIERDO Y DERECHO LADO CAJA (IMPORTADO)	6357
	CUBRE POLVO DERECHO LADO CAJA	6375
	CUBRE POLVO IZQUIERDO Y DERECHO LADO RUEDA	6378
	CUBRE POLVO IZQUIERDO Y DERECHO LADO CAJA	6380



CONTINUACIÓN... CENTURY

 28		APLICACIÓN / DESCRIPTION	DAI PARTS #
MISCELÁNEOS / AUTOMOTIVE RUBBER PARTS			
82-96		TOPE PARA AMORTIGUADOR FRONTAL IZQUIERDO Y DERECHO	D-0622
		GOMA PARA BARRA ESTABILIZADORA	6425
97-05		BUJE PARA HORQUILLA GRANDE	DAI-1403005
		BUJE PARA HORQUILLA CHICO	DAI-1403006



CHEVELLE

SOPORTES / TRANSMISSION & MOTOR MOUNTS			
L4 1.4	76-86	SOPORTE PARA MOTOR IZQUIERDO Y DERECHO	6771
L4 1.6 L4 1.8	76-86	SOPORTE PARA MOTOR IZQUIERDO Y DERECHO	6771
		SOPORTE PARA TRANSMISIÓN	6887
L6 3.8	58-74	SOPORTE PARA TRANSMISIÓN STD. Y AUT.	1704
L6 5.0 L6 5.7	74-82	SOPORTE PARA MOTOR IZQUIERDO Y DERECHO	1769
		SOPORTE PARA TRANSMISIÓN (TORNILLOS JUNTOS DE 3/4")	1779
		SOPORTE PARA TRANSMISIÓN (TORNILLOS JUNTOS DE 1")	1812



CONTINUACIÓN... CHEVELLE

	 28	APLICACIÓN / DESCRIPTION	DAI PARTS #
MISCELÁNEOS / AUTOMOTIVE RUBBER PARTS			
	78-83	GOMA PARA BARRA ESTABILIZADORA (4X4)	6065
	73-88	TORNILLO ESTABILIZADOR (7", 203.2 mm)	6102
		TORNILLO ESTABILIZADOR (7", 203.2 mm EQUIPO ORIGINAL)	6106

CHEVY

SOPORTES / TRANSMISSION & MOTOR MOUNTS			
L4 1.4	94-03	SOPORTE PARA MOTOR DERECHO FRONTAL <i>SWING, POP, MONZA, JOY Y PICK UP</i>	1905
		SOPORTE PARA MOTOR TRASERO <i>SWING, POP, MONZA, JOY Y PICK UP</i>	1906
		SOPORTE PARA MOTOR IZQUIERDO FRONTAL <i>SWING, POP, MONZA, JOY Y PICK UP</i>	1929
L4 1.6	01-12	SOPORTE PARA MOTOR IZQUIERDO <i>C2</i>	1934
		SOPORTE PARA MOTOR TRASERO CON AIRE <i>C2</i>	1935
		SOPORTE PARA MOTOR DERECHO FRONTAL <i>C2</i>	6905



CONTINUACIÓN... CHEVY

28	APLICACIÓN / DESCRIPTION	DAI PARTS #	DAI KIT PARTS #
BASES PARA AMORTIGUADOR / STRUT MOUNTS			
94-12	BASE PARA AMORTIGUADOR FRONTAL IZQUIERDA Y DERECHA SUPERIOR <i>SWING, POP, MONZA Y JOY</i>	6760	6760-KIT
	COMPLEMENTO PARA BASE DE AMORTIGUADOR FRONTAL IZQUIERDA Y DERECHA INFERIOR <i>SWING, POP, MONZA Y JOY</i>	6762	



CUBRE POLVOS / C.V. BOOTS

94-03	CUBREPOLVO IZQUIERDO Y DERECHO PARA DIRECCION STD. <i>MONZA Y JOY</i>	6311
	CUBREPOLVO IZQUIERDO Y DERECHO LADO RUEDA <i>MONZA Y JOY</i>	6375
	CUBREPOLVO IZQUIERDO Y DERECHO LADO RUEDA <i>MONZA Y JOY</i>	6378
	CUBREPOLVO IZQUIERDO Y DERECHO LADO CAJA <i>MONZA Y JOY</i>	6388
94-12	CUBREPOLVO IZQUIERDO Y DERECHO LADO CAJA (CON TRIPOIDE) <i>MONZA Y JOY</i>	6310



CONTINUACIÓN... CHEVY

		APLICACIÓN / DESCRIPTION	DAI PARTS #
CUBRE POLVOS / C.V. BOOTS			
01-12		CUBREPOLVO IZQUIERDO Y DERECHO LADO RUEDA C2	63100
		CUBREPOLVO IZQUIERDO Y DERECHO LADO CAJA (CON TRIPOIDE) C2	63101
		CUBREPOLVO IZQUIERDO Y DERECHO PARA DIRECCIÓN C2	63102



MISCELÁNEOS / AUTOMOTIVE RUBBER PARTS

94-03		GOMA SUJETADORA DE ESCAPE	6573
		TOPE PARA AMORTIGUADOR TRASERO IZQUIERDO Y DERECHO C2, JOY, MONZA, PICK UP Y SWING	D-038
94-12		TOPE PARA AMORTIGUADOR FRONTAL IZQUIERDO Y DERECHO JOY, MONZA, POP Y SWING	D-037
		BUJE PARA BARRA TENSORA MONZA, C2, JOY Y MONZA	DAI-90445098
		TOPE PARA CAJUELA	92
		GOMA SUJETADORA DE ESCAPE	650
		GOMA PARA BARRA ESTABILIZADORA	6405

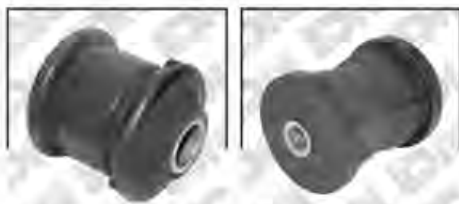

CONTINUACIÓN... CHEVY

		APLICACIÓN / DESCRIPTION	DAI PARTS #
MISCELÁNEOS / AUTOMOTIVE RUBBER PARTS			
	94-12	TOPE PARA AMORTIGUADOR Y CUBRE POLVO FRONTAL IZQUIERDO Y DERECHO <i>JOY, MONZA, POP, SWING Y PICK UP</i>	DAI-054-KIT
		BUJE PARA HORQUILLA INFERIOR <i>BRASIL, MÉXICO, MONZA Y PICK UP</i>	DAI-90445097
		BUJE PARA EJE TRASERO <i>C2, JOY, MONZA Y PICK UP</i>	DAI-90217845
	01-12	TOPE PARA AMORTIGUADOR FRONTAL IZQUIERDO Y DERECHO	D-054



DAI-90445097 DAI-90217845

CHEVY II

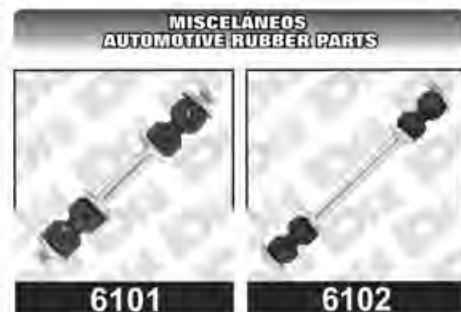

MISCELÁNEOS / AUTOMOTIVE RUBBER PARTS			
	62-74	TORNILLO EXCENTRICO	64600
	62-67	TORNILLO ESTABILIZADOR (6", 177.8 mm)	6101
		TORNILLO ESTABILIZADOR (6", 177.800 mm EQUIPO ORIGINAL)	6105
	68-79	TORNILLO ESTABILIZADOR (7", 203.2 mm)	6102
		TORNILLO ESTABILIZADOR (7", 203.2 mm EQUIPO ORIGINAL)	6106



6105 6106 64600



CHEVY NOVA

		APLICACIÓN / DESCRIPTION	DAI PARTS #
SOPORTES / TRANSMISSION & MOTOR MOUNTS			
L6 4.6	74-80	SOPORTE PARA MOTOR IZQUIERDO Y DERECHO	1771
V6 3.2	71-72	SOPORTE PARA TRANSMISIÓN STD. Y AUT.	1704
		SOPORTE PARA MOTOR IZQUIERDO Y DERECHO	1736
V6 3.8	71-72	SOPORTE PARA TRANSMISIÓN STD. Y AUT.	1704
		SOPORTE PARA MOTOR IZQUIERDO Y DERECHO	1736
V6 4.1	71-72	SOPORTE PARA TRANSMISIÓN STD. Y AUT.	1704
		SOPORTE PARA MOTOR IZQUIERDO Y DERECHO	1736
V6 4.3	71-73	SOPORTE PARA TRANSMISIÓN STD. Y AUT.	1704
		SOPORTE PARA MOTOR IZQUIERDO Y DERECHO	1736
V8 5.7	74-80	SOPORTE PARA TRANSMISIÓN STD. Y AUT. TORNILLOS JUNTOS 38.5mm	1779
V8 6.0			



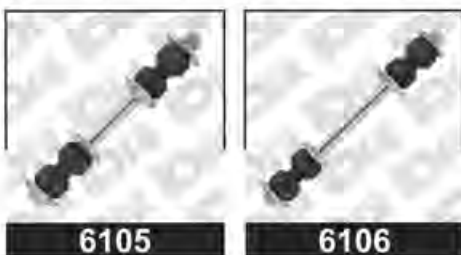

MISCELÁNEOS / AUTOMOTIVE RUBBER PARTS

62-67	TORNILLO ESTABILIZADOR (6", 177.8 mm)	6101
	TORNILLO ESTABILIZADOR (6", 177.8 mm EQUIPO ORIGINAL)	6105
68-79	TORNILLO ESTABILIZADOR (7", 203.2 mm)	6102
	TORNILLO ESTABILIZADOR (7", 203.2 mm EQUIPO ORIGINAL)	6106



CHEYENNE

		 28	APLICACIÓN / DESCRIPTION	DAI PARTS #
SOPORTES / TRANSMISSION & MOTOR MOUNTS				
V6 4.3	07-10	SOPORTE PARA MOTOR IZQUIERDO Y DERECHO		7392
	07-12	SOPORTE PARA TRANSMISIÓN		1940
	07-13	SOPORTE PARA TRANSMISIÓN		1911
V8 4.8	07-13	SOPORTE PARA TRANSMISIÓN		1911
	07-12	SOPORTE PARA TRANSMISIÓN		1940
		SOPORTE PARA TRANSMISIÓN (4X4)		6874
		SOPORTE PARA MOTOR IZQUIERDO Y DERECHO		7365-H
V8 5.3	91-95	SOPORTE PARA MOTOR IZQUIERDO Y DERECHO		1782
	91-12	SOPORTE PARA TRANSMISIÓN		1940
	07-12	SOPORTE PARA TRANSMISIÓN (4X4)		6874
		SOPORTE PARA MOTOR IZQUIERDO Y DERECHO		7365-H
	07-13	SOPORTE PARA TRANSMISIÓN		1911
	14-18	SOPORTE PARA MOTOR DERECHO		7638-H
V8 6.0	07-12	SOPORTE PARA TRANSMISIÓN		1940
		SOPORTE PARA TRANSMISIÓN (4X4)		6874
		SOPORTE PARA MOTOR IZQUIERDO Y DERECHO		7365-H
	07-13	SOPORTE PARA TRANSMISIÓN		1911
V8 6.2	07-12	SOPORTE PARA MOTOR IZQUIERDO Y DERECHO		7365-H
	07-13	SOPORTE PARA TRANSMISIÓN		1911
	14-18	SOPORTE PARA MOTOR DERECHO		7638-H
V8 6.6	07-10	SOPORTE PARA MOTOR IZQUIERDO Y DERECHO		7128
		SOPORTE PARA MOTOR IZQUIERDO Y DERECHO		7401

**SOPORTES
TRANSMISSION & MOTOR MOUNTS**



1782



1911



1940



6874



7128



7365-H



7392



7401



7638-H



CONTINUACIÓN... CHEYENNE

28		APLICACIÓN / DESCRIPTION	DAI PARTS #	DAI KIT PARTS #	BASES PARA AMORTIGUADOR STRUT MOUNTS
BASES PARA AMORTIGUADOR / STRUT MOUNTS					
07-12		BASE PARA AMORTIGUADOR FRONTAL IZQUIERDA Y DERECHA (4X2)		7356-KIT	

7356-KIT

28		APLICACIÓN / DESCRIPTION	DAI PARTS #	MISCELÁNEOS AUTOMOTIVE RUBBER PARTS
MISCELÁNEOS / AUTOMOTIVE RUBBER PARTS				
	00-14	BUJE PARA HORQUILLA SUPERIOR	DAI-K-6395	

DAI-K-6395
CITATION

SOPORTES / TRANSMISSION & MOTOR MOUNTS				SOPORTES TRANSMISSION & MOTOR MOUNTS	
L4 2.5 V6 2.8	80-85	SOPORTE PARA MOTOR DERECHO	1814		
		SOPORTE PARA TRANSMISIÓN TRASERO IZQUIERDO	1837		
		SOPORTE PARA TRANSMISIÓN TRASERO IZQUIERDO	1838		
		SOPORTE PARA TRANSMISIÓN FRONTAL IZQUIERDO	1839		
		SOPORTE DE TORSIÓN FRONTAL SUPERIOR	1864		

1814
1837

1838
1839
1864

CONTINUACIÓN... CITATION

28	APLICACIÓN / DESCRIPTION	DAI PARTS #	DAI KIT PARTS #
BASES PARA AMORTIGUADOR / STRUT MOUNTS			
80-85	BASE PARA AMORTIGUADOR TRASERA IZQUIERDA Y DERECHA	1821	1821-KIT
	BASE PARA AMORTIGUADOR FRONTAL IZQUIERDA Y DERECHA	6666	6666-KIT
	BASE PARA AMORTIGUADOR FRONTAL IZQUIERDA Y DERECHA	6667	6667-KIT



28	APLICACIÓN / DESCRIPTION	DAI PARTS #
CUBRE POLVOS / C.V. BOOTS		
80-85	CUBRE POLVO IZQUIERDO Y DERECHO LADO RUEDA	6304
	CUBRE POLVO DERECHO LADO CAJA	6330
	CUBRE POLVO IZQUIERDO Y DERECHO LADO RUEDA	6351
	CUBRE POLVO IZQUIERDO Y DERECHO LADO CAJA (IMPORTACIÓN)	6357
	CUBRE POLVO IZQUIERDO Y DERECHO LADO CAJA	6358
	CUBRE POLVO IZQUIERDO Y DERECHO DE DIRECCIÓN STD.	6367



CONTINUACIÓN... CITATION

 28		APLICACIÓN / DESCRIPTION	DAI PARTS #
CUBRE POLVOS / C.V. BOOTS			
80-85	CUBRE POLVO IZQUIERDO Y DERECHO DE DIRECCIÓN HID.		6368
	CUBRE POLVO DERECHO LADO CAJA (MANUAL)		6375
	CUBRE POLVO IZQUIERDO Y DERECHO LADO CAJA		6393



MISCELÁNEOS / AUTOMOTIVE RUBBER PARTS			
80-85	TOPE PARA AMORTIGUADOR FRONTAL IZQUIERDO Y DERECHO		D-0622
	GOMA PARA BARRA ESTABILIZADORA		6424
	GOMA PARA BARRA ESTABILIZADORA		6425

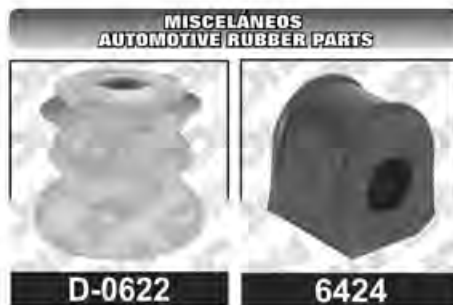

CITATION II

 		APLICACIÓN / DESCRIPTION	DAI PARTS #
SOPORTES / TRANSMISSION & MOTOR MOUNTS			
L4 2.5 V6 2.8	84-85	SOPORTE PARA MOTOR DERECHO	1814
		SOPORTE PARA TRANSMISIÓN TRASERO IZQUIERDO	1837
		SOPORTE PARA TRANSMISIÓN TRASERO IZQUIERDO	1838
		SOPORTE PARA TRANSMISIÓN FRONTAL IZQUIERDO	1839
		SOPORTE PARA MOTOR DERECHO	1970
		SOPORTE PARA MOTOR DERECHO	6633-H



COBALT

SOPORTES / TRANSMISSION & MOTOR MOUNTS			
L4 2.0	05-09	SOPORTE PARA MOTOR DERECHO STD.	7471-H
		SOPORTE PARA MOTOR DERECHO AUT.	7472-H
L4 2.2	05-09	SOPORTE PARA MOTOR DERECHO AUT.	7472-H
		SOPORTE PARA MOTOR DERECHO STD.	7471-H
	05-10	SOPORTE PARA MOTOR TRASERO AUT.	7520



CONTINUACIÓN... COBATL

  APLICACIÓN / DESCRIPTION		DAI PARTS #	
SOPORTES / TRANSMISSION & MOTOR MOUNTS			
L4 2.4	05-08	SOPORTE PARA MOTOR TRASERO AUT.	7520
	06-08	SOPORTE PARA MOTOR DERECHO STD.	7471-H
		SOPORTE PARA MOTOR DERECHO AUT.	7472-H

7520

 APLICACIÓN / DESCRIPTION		DAI PARTS #	DAI KIT PARTS #
BASES PARA AMORTIGUADOR / STRUT MOUNTS			
05-09	BASE PARA AMORTIGUADOR FRONTAL IZQUIERDA Y DERECHA		7636-KIT



  APLICACIÓN / DESCRIPTION		DAI PARTS #
MISCELÁNEOS / AUTOMOTIVE RUBBER PARTS		
04-10	TORNILLO ESTABILIZADOR FRONTAL	DAI-2103001



COLORADO

 		APLICACIÓN / DESCRIPTION	DAI PARTS #
SOPORTES / TRANSMISSION & MOTOR MOUNTS			
L4 2.9	07-12	SOPORTE PARA TRANSMISIÓN (4X4)	6874
L5 3.7	05-12		

**SOPORTES
TRANSMISSION & MOTOR MOUNTS**



6874

CORSA

SOPORTES / TRANSMISSION & MOTOR MOUNTS			
L4 1.8	01-08	SOPORTE PARA MOTOR TRASERO EASY TRONIC Y STD. (COMPLEMENTO 7075)	7074
		SOPORTE PARA MOTOR TRASERO EASY TRONIC Y STD. (COMPLEMENTO 7074)	7075
		SOPORTE PARA TRANSMISIÓN EASY TRONIC Y STD.	7076-H
		SOPORTE PARA MOTOR DERECHO EASY TRONIC Y STD.	7077
		SOPORTE PARA MOTOR FRONTAL EASY TRONIC Y STD.	7086

**SOPORTES
TRANSMISSION & MOTOR MOUNTS**



7074 **7075**





7076-H **7077** **7086**

		APLICACIÓN / DESCRIPTION	DAI PARTS #	DAI KIT PARTS #
BASES PARA AMORTIGUADOR / STRUT MOUNTS				
01-08		BASE PARA AMORTIGUADOR FRONTAL IZQUIERDA Y DERECHA	1997	

**BASES PARA AMORTIGUADOR
STRUT MOUNTS**



1997



CONTINUACIÓN... CORSA

		APLICACIÓN / DESCRIPTION	DAI PARTS #
CUBRE POLVOS / C.V. BOOTS			
01-08		CUBRE POLVO IZQUIERDO Y DERECHO LADO RUEDA	6380
		CUBRE POLVO IZQUIERDO Y DERECHO LADO RUEDA	63107
		CUBRE POLVO IZQUIERDO Y DERECHO LADO CAJA	63108
		CUBRE POLVO IZQUIERDO Y DERECHO DE DIRECCIÓN	63109
		CUBRE POLVO IZQUIERDO Y DERECHO LADO CAJA	63115



MISCELÁNEOS / AUTOMOTIVE RUBBER PARTS			
01-05		TOPE PARA AMORTIGUADOR FRONTAL IZQUIERDO Y DERECHO	D-037
		TOPE PARA AMORTIGUADOR TRASERO IZQUIERDO Y DERECHO	D-038
01-08		TOPE FRONTAL IZQUIERDO Y DERECHO	D-054
		GOMA PARA BARRA ESTABILIZADORA 3/4"	64691
		BUJE PARA HORQUILLA INFERIOR CHICO	DAI-1403007
		BUJE PARA HORQUILLA INFERIOR CHICO (REFORZADO)	DAI-1403007 R

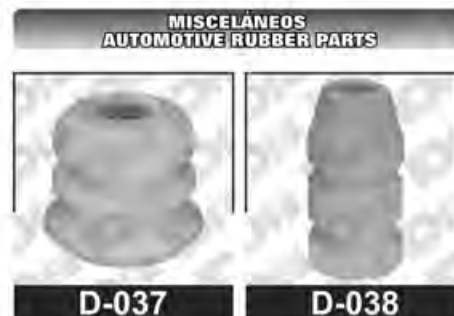

CONTINUACIÓN... CORSA

 		APLICACIÓN / DESCRIPTION	DAI PARTS #
MISCELÁNEOS / AUTOMOTIVE RUBBER PARTS			
01-08		GOMA PARA BARRA ESTABILIZADORA 3/4"	64731
		GOMA PARA BARRA ESTABILIZADORA 1"	64733
		TORNILLO ESTABILIZADOR FRONTAL	DAI-2103001
		BUJE PARA EJE TRASERO	DAI-1403046

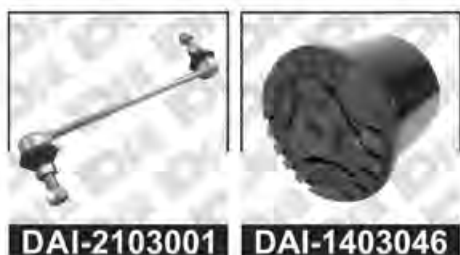

CORSICA

SOPORTES / TRANSMISSION & MOTOR MOUNTS			
L4 2.0	87-89	SOPORTE PARA MOTOR TRASERO	1909
		SOPORTE PARA MOTOR FRONTAL DERECHO	1971
		SOPORTE PARA MOTOR FRONTAL DERECHO	1972
		SOPORTE PARA MOTOR TRASERO	1980
		SOPORTE PARA TRANSMISIÓN	6655
		REPUESTO PARA SOPORTE DE TRANSMISIÓN (6655)	6642
		SOPORTE PARA MOTOR TRASERO DERECHO	6795
L4 2.2	92-96	SOPORTE PARA MOTOR TRASERO	1909
		SOPORTE PARA MOTOR FRONTAL DERECHO	1971



CONTINUACIÓN.. CORSICA

 		APLICACIÓN / DESCRIPTION	DAI PARTS #	SOPORTES TRANSMISSION & MOTOR MOUNTS	
L4 2.2	92-96	SOPORTE PARA MOTOR FRONTAL DERECHO	1972		
		SOPORTE PARA MOTOR TRASERO	1980		
		REPUESTO PARA SOPORTE DE TRANSMISIÓN (6655)	6642		
		SOPORTE PARA TRANSMISIÓN	6655		
		SOPORTE PARA MOTOR TRASERO DERECHO	6795		
		REPUESTO PARA SOPORTE PARA MOTOR DERECHO	6837-9		
		REPUESTO PARA SOPORTE PARA MOTOR DERECHO	6837-H		
		SOPORTE PARA MOTOR DERECHO	6975		
		SOPORTE PARA MOTOR FRONTAL DERECHO INFERIOR (BUJE LARGO 60.24 mm)	6936		
V6 2.8	87-91	SOPORTE PARA MOTOR TRASERO	1909		
		SOPORTE PARA MOTOR FRONTAL DERECHO	1971		
		SOPORTE PARA MOTOR FRONTAL DERECHO	1972		
		SOPORTE PARA MOTOR TRASERO	1980		
		SOPORTE PARA MOTOR TRASERO DERECHO	6638		
		SOPORTE PARA MOTOR TRASERO	6647		
		SOPORTE PARA MOTOR TRASERO DERECHO	6795		
		SOPORTE PARA TRANSMISIÓN	6655		
V6 3.1	87-91	SOPORTE PARA MOTOR TRASERO	1909		
		SOPORTE PARA MOTOR FRONTAL DERECHO	1971		
		SOPORTE PARA MOTOR FRONTAL DERECHO	1972		
		SOPORTE PARA MOTOR TRASERO	1980		

6837-H
6837-9
6975
6795
6936

CONTINUACIÓN.. CORSICA



 		APLICACIÓN / DESCRIPTION	DAI PARTS #
SOPORTES / TRANSMISSION & MOTOR MOUNTS			
V6 3.1	87-91	SOPORTE PARA MOTOR TRASERO DERECHO	6638
		SOPORTE PARA MOTOR TRASERO	6647
		SOPORTE PARA TRANSMISIÓN	6655
		SOPORTE PARA MOTOR TRASERO DERECHO	6795
92-96	92-96	REPUESTO PARA SOPORTE PARA MOTOR DERECHO	6837-9
		REPUESTO PARA SOPORTE PARA MOTOR DERECHO	6837-H
95-96	95-96	SOPORTE PARA MOTOR FRONTAL DERECHO INFERIOR (BUJE LARGO 60.24 mm)	6936



 		APLICACIÓN / DESCRIPTION	DAI PARTS #	DAI KIT PARTS #
BASES PARA AMORTIGUADOR / STRUT MOUNTS				
87-96	87-96	BASE PARA AMORTIGUADOR TRASERA IZQUIERDA Y DERECHA	1821	1821-KIT
		BASE PARA AMORTIGUADOR FRONTAL IZQUIERDA Y DERECHA	6711	6711-KIT
		BASE PARA AMORTIGUADOR FRONTAL IZQUIERDA Y DERECHA	6731	6731-KIT



CONTINUACIÓN... CORSICA

 		APLICACIÓN / DESCRIPTION	DAI PARTS #
MISCELÁNEOS / AUTOMOTIVE RUBBER PARTS			
87-96		GOMA PARA BARRA ESTABILIZADORA	6402
		GOMA PARA BARRA ESTABILIZADORA	6403

CORVETTE

SOPORTES / TRANSMISSION & MOTOR MOUNTS			
V8 5.7	84-91	SOPORTE PARA MOTOR IZQUIERDO Y DERECHO	6836
	97-04	SOPORTE PARA TRANSMISIÓN	7239-H



MISCELÁNEOS / AUTOMOTIVE RUBBER PARTS			
	63-82	TORNILLO ESTABILIZADOR (5", 154.24 mm)	6100
		TORNILLO ESTABILIZADOR (5", 154.24 mm) EQUIPO ORIGINAL	6104

CRUZE

SOPORTES / TRANSMISSION & MOTOR MOUNTS			
L4 1.4	15-16	SOPORTE PARA TRANSMISIÓN STD. (TURBO)	7387
		SOPORTE PARA MOTOR TRASERO (TURBO)	7313





CONTINUACIÓN.. CRUZE

 		APLICACIÓN / DESCRIPTION	DAI PARTS #
SOPORTES / TRANSMISSION & MOTOR MOUNTS			
L4 1.4	15-16	SOPORTE PARA MOTOR DERECHO (TURBO)	7402-H
		SOPORTE PARA MOTOR FRONTAL (TURBO)	7525
L4 1.8	10-16	SOPORTE PARA MOTOR TRASERO	7313
		SOPORTE PARA TRANSMISIÓN STD.	7387
		SOPORTE PARA TRANSMISIÓN AUT.	7388
		SOPORTE PARA MOTOR FRONTAL AUT.	7403
		SOPORTE PARA MOTOR DERECHO	7402-H
		SOPORTE PARA MOTOR FRONTAL STD.	7451





		APLICACIÓN / DESCRIPTION	DAI PARTS #	DAI KIT PARTS #
BASES PARA AMORTIGUADOR / STRUT MOUNTS				
10-16		BASE PARA AMORTIGUADOR FRONTAL IZQUIERDA Y DERECHA	7385	
		BASE PARA AMORTIGUADOR TRASERA IZQUIERDA Y DERECHA	7386	



 		APLICACIÓN / DESCRIPTION	DAI PARTS #
CUBRE POLVOS / C.V. BOOTS			
	10-16	CUBRE POLVO IZQUIERDO Y DERECHO DE DIRECCIÓN	6345
		CUBRE POLVO IZQUIERDO Y DERECHO LADO RUEDA	63129



CONTINUACIÓN... CRUZE

		APLICACIÓN / DESCRIPTION	DAI PARTS #
CUBRE POLVOS / C.V. BOOTS			
	10-16	CUBRE POLVO IZQUIERDO Y DERECHO LADO CAJA	63130

CUTLASS

SOPORTES / TRANSMISSION & MOTOR MOUNTS			
V6 2.8	85-88	SOPORTE PARA MOTOR DERECHO	1814
	85-95	SOPORTE PARA TRANSMISIÓN TRASERO IZQUIERDO	1837
		SOPORTE PARA TRANSMISIÓN TRASERO IZQUIERDO	1838
		SOPORTE PARA TRANSMISIÓN FRONTAL IZQUIERDO	1839
		SOPORTE DE TORSIÓN FRONTAL SUPERIOR	1864
	89-95	SOPORTE PARA MOTOR DERECHO	6633-H



V6 3.1	85-88	SOPORTE PARA MOTOR DERECHO	1814
	85-95	SOPORTE PARA TRANSMISIÓN TRASERO IZQUIERDO	1837
		SOPORTE PARA TRANSMISIÓN TRASERO IZQUIERDO	1838
		SOPORTE PARA TRANSMISIÓN FRONTAL IZQUIERDO	1839



CONTINUACIÓN.. CUTLASS

 		APLICACIÓN / DESCRIPTION	DAI PARTS #
SOPORTES / TRANSMISSION & MOTOR MOUNTS			
V6 3.1	85-95	SOPORTE DE TORSIÓN FRONTAL SUPERIOR	1864
	89-95	SOPORTE PARA MOTOR DERECHO	1970
		SOPORTE PARA MOTOR DERECHO	6633-H
	97-99	SOPORTE PARA TRANSMISIÓN CENTRAL	6979
		SOPORTE PARA MOTOR DERECHO	6980-H
REPUESTO PARA SOPORTE FRONTAL Y TRASERO DE TRANSMISIÓN		6985	



		APLICACIÓN / DESCRIPTION	DAI PARTS #	DAI KIT PARTS #
BASES PARA AMORTIGUADOR / STRUT MOUNTS				
82-96		BASE PARA AMORTIGUADOR TRASERA IZQUIERDA Y DERECHA	1821	1821-KIT
		BASE PARA AMORTIGUADOR FRONTAL IZQUIERDA Y DERECHA	6666	6666-KIT
		BASE PARA AMORTIGUADOR FRONTAL IZQUIERDA Y DERECHA	6667	6667-KIT



CONTINUACIÓN... CUTLASS

		APLICACIÓN / DESCRIPTION	DAI PARTS #
CUBRE POLVOS / C.V. BOOTS			
82-96		CUBRE POLVO IZQUIERDO Y DERECHO LADO RUEDA	6304
		CUBRE POLVO IZQUIERDO Y DERECHO LADO CAJA (IMPORTACIÓN)	6357
82-96		CUBRE POLVO IZQUIERDO Y DERECHO LADO CAJA	6359
		CUBRE POLVO IZQUIERDO Y DERECHO LADO RUEDA	6378
		CUBRE POLVO IZQUIERDO Y DERECHO LADO RUEDA	6380

MISCELÁNEOS / AUTOMOTIVE RUBBER PARTS

82-96		TOPE PARA AMORTIGUADOR FRONTAL IZQUIERDO Y DERECHO	D-0622
		GOMA PARA CREMALLERA DE DIRECCIÓN (DERECHA PAR 717)	701
		GOMA PARA CREMALLERA DE DIRECCIÓN (IZQUIERDA PAR 701)	717
		GOMA PARA BARRA ESTABILIZADORA	6425
97-99		BUJES PARA HORQUILLA	DAI-K-6578



CUTLASS CALAIS

 		APLICACIÓN / DESCRIPTION	DAI PARTS #
SOPORTES / TRANSMISSION & MOTOR MOUNTS			
L4 2.3	88-91	SOPORTE PARA MOTOR TRASERO	1909
L4 2.5	85-91	SOPORTE PARA MOTOR TRASERO	1909
		SOPORTE PARA MOTOR FRONTAL DERECHO	1971
		SOPORTE PARA MOTOR FRONTAL DERECHO	1972
		SOPORTE PARA MOTOR TRASERO	1980
		REPUESTO PARA SOPORTE DE TRANSMISIÓN (6655)	6642
		SOPORTE PARA TRANSMISIÓN	6655
V6 3.0	85-91	SOPORTE PARA MOTOR TRASERO	1909
		SOPORTE PARA MOTOR TRASERO	1980
		REPUESTO PARA SOPORTE DE TRANSMISIÓN (6655)	6642
		SOPORTE PARA TRANSMISIÓN	6655
		SOPORTE PARA MOTOR DERECHO	6872
V6 3.3	85-91	SOPORTE PARA MOTOR TRASERO	1909
		SOPORTE PARA MOTOR TRASERO	1980
		REPUESTO PARA SOPORTE DE TRANSMISIÓN (6655)	6642
		SOPORTE PARA TRANSMISIÓN	6655
		SOPORTE PARA MOTOR DERECHO	6872
V6 3.8	78-84	SOPORTE PARA TRANSMISIÓN STD.	1932
		SOPORTE PARA TRANSMISIÓN STD.	6766
	78-79	SOPORTE PARA TRANSMISIÓN	6770

SOPORTES TRANSMISSION & MOTOR MOUNTS



1909 1932

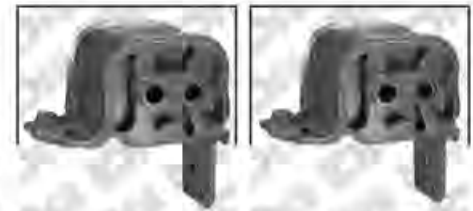

1971 1972

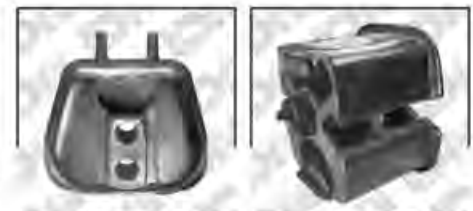

1980 6642



6655 6766



6770



6872



CONTINUACIÓN... CUTLASS CALAIS

 		APLICACIÓN / DESCRIPTION	DAI PARTS #
SOPORTES / TRANSMISSION & MOTOR MOUNTS			
V6 3.8	78-79	SOPORTE PARA MOTOR DERECHO	6791
		SOPORTE PARA TRANSMISIÓN	6874
V8 4.3	83-84	SOPORTE PARA MOTOR IZQUIERDO Y DERECHO	1782
	78-79	SOPORTE PARA TRANSMISIÓN STD.	1932
		SOPORTE PARA TRANSMISIÓN STD.	6766
		SOPORTE PARA TRANSMISIÓN	6874
	78-84	SOPORTE PARA TRANSMISIÓN (TIPO UNIVERSAL)	6800



		APLICACIÓN / DESCRIPTION	DAI PARTS #	DAI KIT PARTS #
BASES PARA AMORTIGUADOR / STRUT MOUNTS				
85-91		BASE PARA AMORTIGUADOR FRONTAL IZQUIERDA Y DERECHA	1821	1821-KIT
		BASE PARA AMORTIGUADOR FRONTAL IZQUIERDA Y DERECHA	6710	6710-KIT
		BASE PARA AMORTIGUADOR FRONTAL IZQUIERDA Y DERECHA	6711	6711-KIT



CONTINUACIÓN... CUTLASS CALAIS

 		APLICACIÓN / DESCRIPTION	DAI PARTS #
MISCELÁNEOS / AUTOMOTIVE RUBBER PARTS			
85-91	TORNILLO ESTABILIZADOR (7", 203.2 mm)	6102	
	TORNILLO ESTABILIZADOR (7", 203.2 mm EQUIPO ORIGINAL)	6106	
	GOMA PARA BARRA ESTABILIZADORA	6402	
	GOMA PARA BARRA ESTABILIZADORA	6403	





CUTLASS CIERA

SOPORTES / TRANSMISSION & MOTOR MOUNTS			
L4 2.2	93-94	SOPORTE DE TORSIÓN FRONTAL SUPERIOR	6781
	93-96	SOPORTE PARA MOTOR DERECHO	1970
		SOPORTE PARA MOTOR DERECHO	6633-H
	95-96	SOPORTE DE TORSIÓN FRONTAL SUPERIOR (15.5 mm)	7172
		REPUESTO PARA SOPORTE DE TORSIÓN FRONTAL SUPERIOR IZQUIERDO Y DERECHO (7172)	7172-9





CONTINUACIÓN... CUTLASS CIERA

 		APLICACIÓN / DESCRIPTION	DAI PARTS #
SOPORTES / TRANSMISSION & MOTOR MOUNTS			
L4 2.2	93-96	SOPORTE PARA MOTOR DERECHO	6633-H
	95-96	SOPORTE DE TORSIÓN FRONTAL SUPERIOR (15.5 mm)	7172
		REPUESTO PARA SOPORTE DE TORSIÓN FRONTAL SUPERIOR IZQUIERDO Y DERECHO (7172)	7172-9
L4 2.5	82-84	SOPORTE PARA MOTOR DERECHO	1814
		SOPORTE PARA TRANSMISIÓN FRONTAL IZQUIERDO	1839
		SOPORTE PARA TRANSMISIÓN TRASERO IZQUIERDO	1837
		SOPORTE PARA TRANSMISIÓN TRASERO IZQUIERDO	1838
	82-92	SOPORTE DE TORSIÓN FRONTAL SUPERIOR	1864
	85-92	SOPORTE PARA MOTOR DERECHO	1970
SOPORTE PARA MOTOR DERECHO		6633-H	
V6 2.8 V6 3.0	82-84	SOPORTE PARA MOTOR DERECHO	1814
		SOPORTE PARA TRANSMISIÓN TRASERO IZQUIERDO	1837
		SOPORTE PARA TRANSMISIÓN TRASERO IZQUIERDO	1838
		SOPORTE PARA TRANSMISIÓN FRONTAL IZQUIERDO	1839
		SOPORTE DE TORSIÓN FRONTAL SUPERIOR	1864
	85-89	SOPORTE PARA MOTOR DERECHO	1970
		SOPORTE PARA MOTOR DERECHO	6633-H
V6 3.1	94-96	SOPORTE PARA TRANSMISIÓN TRASERO IZQUIERDO	1837



CONTINUACIÓN... CUTLASS CIERA

 		APLICACIÓN / DESCRIPTION	DAI PARTS #
SOPORTES / TRANSMISSION & MOTOR MOUNTS			
V6 3.1	94-96	SOPORTE PARA TRANSMISIÓN TRASERO IZQUIERDO	1838
		SOPORTE PARA TRANSMISIÓN FRONTAL IZQUIERDO	1839
		SOPORTE PARA MOTOR DERECHO	1970
		SOPORTE DE TORSIÓN FRONTAL SUPERIOR (15.5 mm)	7172
		SOPORTE PARA MOTOR DERECHO	6633-H
		REPUESTO PARA SOPORTE DE TORSIÓN FRONTAL SUPERIOR IZQUIERDO Y DERECHO (7172)	7172-9
V6 3.3	89-93	SOPORTE PARA TRANSMISIÓN TRASERO IZQUIERDO	1837
		SOPORTE PARA TRANSMISIÓN TRASERO IZQUIERDO	1838
		SOPORTE PARA TRANSMISIÓN FRONTAL IZQUIERDO	1839
		SOPORTE DE TORSIÓN FRONTAL SUPERIOR	1864
		SOPORTE PARA MOTOR DERECHO	1970
		SOPORTE PARA MOTOR DERECHO	6633-H
V6 3.8	1984	SOPORTE PARA MOTOR DERECHO	1814
	84-86	SOPORTE DE TORSIÓN FRONTAL SUPERIOR	6778
	84-88	SOPORTE PARA TRANSMISIÓN TRASERO IZQUIERDO	1837
		SOPORTE PARA TRANSMISIÓN TRASERO IZQUIERDO	1838
		SOPORTE PARA TRANSMISIÓN FRONTAL IZQUIERDO	1839



7172



7172-9

CONTINUACIÓN... CUTLASS CIERA

 		APLICACIÓN / DESCRIPTION	DAI PARTS #
SOPORTES / TRANSMISSION & MOTOR MOUNTS			
V6 3.8	85-88	SOPORTE PARA MOTOR DERECHO	1970
		SOPORTE PARA MOTOR DERECHO	6633-H
	87-88	SOPORTE DE TORSIÓN FRONTAL SUPERIOR	1864

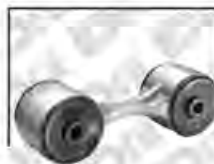
6633-H
**SOPORTES
TRANSMISSION & MOTOR MOUNTS**

1864

1970

		APLICACIÓN / DESCRIPTION	DAI PARTS #	DAI KIT PARTS #
BASES PARA AMORTIGUADOR / STRUT MOUNTS				
82-96		BASE PARA AMORTIGUADOR TRASERA IZQUIERDA Y DERECHA	1821	1821-KIT
		BASE PARA AMORTIGUADOR FRONTAL IZQUIERDA Y DERECHA	6666	6666-KIT
		BASE PARA AMORTIGUADOR FRONTAL IZQUIERDA Y DERECHA	6667	6667-KIT

**BASES PARA AMORTIGUADOR
STRUT MOUNTS**

1821

1821-KIT

6666

6666-KIT

6667

6667-KIT

CUTLASS SUPREME

		APLICACIÓN / DESCRIPTION	DAI PARTS #
SOPORTES / TRANSMISSION & MOTOR MOUNTS			
L4 2.3	90-91	SOPORTE DE TORSIÓN FRONTAL SUPERIOR	1864
		SOPORTE PARA MOTOR DERECHO	6838-H
		SOPORTE PARA MOTOR DERECHO	6875-H
		SOPORTE PARA TRANSMISIÓN	6920
V6 2.8	88-89	SOPORTE PARA MOTOR DERECHO	6838-H
		SOPORTE PARA MOTOR DERECHO	6875-H
		SOPORTE PARA MOTOR IZQUIERDO	6871
		SOPORTE PARA TRANSMISIÓN	6920
V6 3.1	89-93	SOPORTE PARA TRANSMISIÓN	6920
	89-94	SOPORTE DE TORSIÓN FRONTAL SUPERIOR (1RA. EDICIÓN)	6781
	89-96	SOPORTE PARA MOTOR DERECHO	6838-H
		SOPORTE PARA MOTOR DERECHO	6875-H
	94-97	SOPORTE DE TORSIÓN FRONTAL SUPERIOR (2DA. EDICIÓN 15.5 mm)	7172
		REPUESTO PARA SOPORTE DE TORSIÓN FRONTAL SUPERIOR IZQUIERDO Y DERECHO (7172)	7172-9
	94-96	SOPORTE PARA TRANSMISIÓN AUT.	7239-H
94-97	SOPORTE PARA MOTOR FRONTAL SUPERIOR IZQUIERDO Y DERECHO	7166	
V6 3.4	91-94	SOPORTE PARA TRANSMISIÓN AUT.	7239-H
	91-96	SOPORTE PARA MOTOR DERECHO	6918-H
	1993	SOPORTE PARA TRANSMISIÓN	6920



CONTINUACIÓN... CUTLASS SUPREME

28		APLICACIÓN / DESCRIPTION	DAI PARTS #
SOPORTES / TRANSMISSION & MOTOR MOUNTS			
V6 4.1	85-90	SOPORTE PARA TRANSMISIÓN FRONTAL IZQUIERDO	6779
V6 4.3			
V6 4.5			

**SOPORTES
TRANSMISSION & MOTOR MOUNTS**

6779
DENALI

SOPORTES / TRANSMISSION & MOTOR MOUNTS			
V6 4.3	07-13	SOPORTE PARA MOTOR IZQUIERDO Y DERECHO	7392
		SOPORTE PARA TRANSMISIÓN	1911
		SOPORTE PARA TRANSMISIÓN	1940
V8 4.8	00-11	SOPORTE PARA TRANSMISIÓN	1911
		SOPORTE PARA TRANSMISIÓN	1940
		SOPORTE PARA TRANSMISIÓN (4X4)	6874
	00-07	SOPORTE PARA MOTOR IZQUIERDO Y DERECHO	7120
	07-12	SOPORTE PARA MOTOR IZQUIERDO Y DERECHO	7365-H
V8 5.3	00-07	SOPORTE PARA MOTOR IZQUIERDO Y DERECHO	7120
	00-11	SOPORTE PARA TRANSMISIÓN	1911
		SOPORTE PARA TRANSMISIÓN	1940
		SOPORTE PARA TRANSMISIÓN (4X4)	6874
	07-12	SOPORTE PARA MOTOR IZQUIERDO Y DERECHO	7365-H

**SOPORTES
TRANSMISSION & MOTOR MOUNTS**

1911

1940



6874

7120

7365-H

7392

CONTINUACIÓN... DENALI

			APLICACIÓN / DESCRIPTION	DAI PARTS #
SOPORTES / TRANSMISSION & MOTOR MOUNTS				
V8 5.7	92-99		SOPORTE PARA MOTOR IZQUIERDO Y DERECHO	1920
	92-00		SOPORTE PARA TRANSMISIÓN (4X4)	6874
	2000		SOPORTE PARA MOTOR IZQUIERDO Y DERECHO	7120
	92-00		SOPORTE PARA MOTOR IZQUIERDO Y DERECHO	6931
V8 6.0	00-11		SOPORTE PARA TRANSMISIÓN	1911
	01-07		SOPORTE PARA MOTOR IZQUIERDO Y DERECHO	7120
	01-11		SOPORTE PARA TRANSMISIÓN	1940
			SOPORTE PARA TRANSMISIÓN (4X4)	6874
	07-12		SOPORTE PARA MOTOR IZQUIERDO Y DERECHO	7365-H
V8 6.2	07-12		SOPORTE PARA MOTOR IZQUIERDO Y DERECHO	7365-H
	15-18		SOPORTE PARA MOTOR DERECHO	7638-H
V8 6.5	92-99		SOPORTE PARA MOTOR IZQUIERDO Y DERECHO	1920
	92-00		SOPORTE PARA MOTOR IZQUIERDO Y DERECHO	6931
	94-99		SOPORTE PARA TRANSMISIÓN (4X4)	6874

SOPORTES TRANSMISSION & MOTOR MOUNTS



1911 1920



1940 6874



6931 7120



7365-H 7638-H

ENVOY

SOPORTES / TRANSMISSION & MOTOR MOUNTS				
L6 4.2	02-08		SOPORTE PARA MOTOR IZQUIERDO Y DERECHO	7244-H
			SOPORTE PARA TRANSMISIÓN AUT.	7311

SOPORTES TRANSMISSION & MOTOR MOUNTS



7244-H 7311



CONTINUACIÓN... ENVOY

 		APLICACIÓN / DESCRIPTION	DAI PARTS #
MISCELÁNEOS / AUTOMOTIVE RUBBER PARTS			
02-08		GOMA PARA BARRA ESTABILIZADORA	64712
		BUJE PARA HORQUILLA SUPERIOR	DAI-1403010
		BUJE PARA HORQUILLA INFERIOR CHICO	DAI-1403013
		BUJE PARA HORQUILLA INFERIOR GRANDE	DAI-1403014

EQUINOX

SOPORTES / TRANSMISSION & MOTOR MOUNTS			
L4 2.4	10-16	SOPORTE PARA MOTOR FRONTAL	7692
V6 3.0	10-12	SOPORTE PARA MOTOR FRONTAL	7691
	10-16	SOPORTE PARA MOTOR DERECHO	7541-H
V6 3.4	05-08	SOPORTE PARA MOTOR TRASERO	7220
		SOPORTE PARA MOTOR FRONTAL	7238
	05-09	SOPORTE PARA MOTOR DERECHO	7473-H
V6 3.6	13-16	SOPORTE PARA MOTOR FRONTAL	7691



CONTINUACIÓN... EQUINOX

28	APLICACIÓN / DESCRIPTION	DAI PARTS #	DAI KIT PARTS #
BASES PARA AMORTIGUADOR / STRUT MOUNTS			
05-06	BASE PARA AMORTIGUADOR FRONTAL IZQUIERDA Y DERECHA		7539-KIT

BASES PARA AMORTIGUADOR STRUT MOUNTS

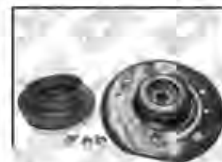

7539-KIT

28	APLICACIÓN / DESCRIPTION	DAI PARTS #
MISCELÁNEOS / AUTOMOTIVE RUBBER PARTS		
05-08	BUJE PARA HORQUILLA INFERIOR GRANDE	DAI-1403022
05-09	BUJE PARA HORQUILLA INFERIOR CHICO	DAI-1403019

MISCELÁNEOS AUTOMOTIVE RUBBER PARTS



DAI-1403019



DAI-1403022

EXPRESS

SOPORTES / TRANSMISSION & MOTOR MOUNTS			
V6 4.3	96-02	SOPORTE PARA MOTOR IZQUIERDO Y DERECHO	1920
V8 4.8	03-13	SOPORTE PARA MOTOR IZQUIERDO Y DERECHO	7401
V8 5.3			
V8 6.0	03-14	SOPORTE PARA TRANSMISIÓN	7474
V8 5.0	96-02	SOPORTE PARA MOTOR IZQUIERDO Y DERECHO	1920
V8 5.7			
V8 6.5			
V8 7.4			
V8 8.1			

SOPORTES TRANSMISSION & MOTOR MOUNTS



1920



7401



7474



CONTINUACIÓN... EXPRESS

	28	APLICACIÓN / DESCRIPTION	DAI PARTS #
MISCELÁNEOS / AUTOMOTIVE RUBBER PARTS			
	00-09	TOPE PARA AMORTIGUADOR TRASERO IZQUIERDO Y DERECHO VAN	2012
	96-02	TORNILLO ESTABILIZADOR (243 mm EQUIPO ORIGINAL) VAN	6107
		BUJES PARA HORQUILLA SUPERIOR VAN 1500, VAN 2500	DAI-K-6323
	96-14	BUJE PARA HORQUILLA SUPERIOR VAN 1500, VAN 2500, VAN G2500 7700, 8500, 8600 LBS., VAN G3500	DAI-K-6395

GEO PRIZM

SOPORTES / TRANSMISSION & MOTOR MOUNTS			
L4 1.6	93-97	SOPORTE PARA MOTOR TRASERO	7696
L4 1.8			
L4 1.8	98-02	SOPORTE PARA MOTOR DERECHO	7780-H

HHR

SOPORTES / TRANSMISSION & MOTOR MOUNTS			
L4 2.0	06-09	SOPORTE PARA MOTOR TRASERO STD.	7233
		SOPORTE PARA MOTOR FRONTAL	7234



CONTINUACIÓN... HHR

 		APLICACIÓN / DESCRIPTION	DAI PARTS #
SOPORTES / TRANSMISSION & MOTOR MOUNTS			
L4 2.0	08-09	SOPORTE PARA MOTOR DERECHO STD.	7471-H
		SOPORTE PARA MOTOR DERECHO AUT.	7472-H
	08-11	SOPORTE PARA MOTOR TRASERO AUT.	7520
L4 2.2	06-09	SOPORTE PARA MOTOR TRASERO STD.	7233
		SOPORTE PARA MOTOR FRONTAL	7234
		SOPORTE PARA MOTOR DERECHO STD.	7471-H
		SOPORTE PARA MOTOR DERECHO AUT.	7472-H
	06-11	SOPORTE PARA MOTOR TRASERO AUT.	7520
L4 2.4	06-09	SOPORTE PARA MOTOR TRASERO STD.	7233
		SOPORTE PARA MOTOR FRONTAL	7234
		SOPORTE PARA MOTOR DERECHO STD.	7471-H
		SOPORTE PARA MOTOR DERECHO AUT.	7472-H
	06-11	SOPORTE PARA MOTOR TRASERO AUT.	7520



		APLICACIÓN / DESCRIPTION	DAI PARTS #	DAI KIT PARTS #
BASES PARA AMORTIGUADOR / STRUT MOUNTS				
05-11		BASE PARA AMORTIGUADOR FRONTAL IZQUIERDA Y DERECHA		7636-KIT



CONTINUACIÓN... HHR

 28	APLICACIÓN / DESCRIPTION	DAI PARTS #
MISCELÁNEOS / AUTOMOTIVE RUBBER PARTS		
06-11	TORNILLO ESTABILIZADOR FRONTAL	DAI-2103001

**MISCELÁNEOS
AUTOMOTIVE RUBBER PARTS**

DAI-2103001
HUMMER H2

SOPORTES / TRANSMISSION & MOTOR MOUNTS			
V8 6.0	03-08	SOPORTE PARA TRANSMISIÓN	6874
		SOPORTE PARA MOTOR IZQUIERDO Y DERECHO	7120
	04-07	SOPORTE PARA BARRA DE TORSIÓN	7548

**SOPORTES
TRANSMISSION & MOTOR MOUNTS**

6874

7120

7548
IMPALA



SOPORTES / TRANSMISSION & MOTOR MOUNTS			
L4 2.4	2014	SOPORTE PARA MOTOR DERECHO	7771-H
	14-17	SOPORTE PARA MOTOR DERECHO	7772-H

**SOPORTES
TRANSMISSION & MOTOR MOUNTS**

7771-H

7772-H

CONTINUACIÓN... IMPALA

			APLICACIÓN / DESCRIPTION	DAI PARTS #
SOPORTES / TRANSMISSION & MOTOR MOUNTS				
L4 2.4	2014	SOPORTE PARA MOTOR TRASERO		7313
		SOPORTE PARA MOTOR FRONTAL		7602
L4 2.5	14-16	SOPORTE PARA MOTOR FRONTAL		7602
		SOPORTE PARA MOTOR TRASERO		7313
	14-17	SOPORTE PARA MOTOR DERECHO		7772-H
L6 4.1	73-84	SOPORTE PARA TRANSMISIÓN STD. 3 VEL.		1704
	73-85	SOPORTE PARA TRANSMISIÓN AUT.		1757
		SOPORTE PARA MOTOR IZQUIERDO Y DERECHO		1782
V6 3.4	00-05	SOPORTE PARA TRANSMISIÓN		6844
		SOPORTE PARA MOTOR FRONTAL SUPERIOR IZQUIERDO Y DERECHO		7166
		SOPORTE PARA MOTOR DERECHO		6838-H
		SOPORTE PARA MOTOR DERECHO		6875-H
		REPUESTO PARA SOPORTE DE TORSIÓN FRONTAL SUPERIOR IZQUIERDO Y DERECHO (7172)		7172-9
V6 3.5	99-09	SOPORTE PARA MOTOR FRONTAL		7483-H
	06-10	SOPORTE PARA MOTOR DERECHO		6838-H
		SOPORTE PARA TRANSMISIÓN		6844
		SOPORTE PARA MOTOR DERECHO		6875-H
		REPUESTO PARA SOPORTE DE TORSIÓN FRONTAL SUPERIOR IZQUIERDO Y DERECHO (7172)		7172-9

SOPORTES TRANSMISSION & MOTOR MOUNTS



1704 **1757**



1782 **6838-H**



6844 **6875-H**



7166 **7172-9**



7313 **7483-H**



7484



7602



7772-H



CONTINUACIÓN... IMPALA

		APLICACIÓN / DESCRIPTION	DAI PARTS #
SOPORTES / TRANSMISSION & MOTOR MOUNTS			
V6 3.5	06-11	SOPORTE PARA MOTOR FRONTAL SUPERIOR IZQUIERDO Y DERECHO	7484
V6 3.6	14-16	SOPORTE PARA MOTOR TRASERO	7313
		SOPORTE PARA MOTOR TRASERO	7760-H
		SOPORTE PARA MOTOR FRONTAL	7602
V6 3.8	80-85	SOPORTE PARA TRANSMISIÓN	6770
		SOPORTE PARA MOTOR DERECHO	6791
		SOPORTE PARA MOTOR DERECHO	6888
		SOPORTE PARA MOTOR IZQUIERDO	6889
	83-85	SOPORTE PARA TRANSMISIÓN (TIPO UNIVERSAL)	6800
	00-05	SOPORTE PARA MOTOR DERECHO	6838-H
		SOPORTE PARA MOTOR DERECHO	6875-H
		REPUESTO PARA SOPORTE DE TORSIÓN FRONTAL SUPERIOR IZQUIERDO Y DERECHO (7172)	7172-9
		SOPORTE PARA TRANSMISIÓN	7239-H
			SOPORTE PARA MOTOR FRONTAL SUPERIOR IZQUIERDO Y DERECHO

**SOPORTES
TRANSMISSION & MOTOR MOUNTS**

6770

6791

6800

6838-H

6875-H

6888

6889

7172-9

7239-H

7313

7362

7484

7602

7760-H

CONTINUACIÓN... IMPALA

 		APLICACIÓN / DESCRIPTION	DAI PARTS #
SOPORTES / TRANSMISSION & MOTOR MOUNTS			
V6 3.9	06-10	SOPORTE PARA MOTOR DERECHO	6838-H
		SOPORTE PARA MOTOR DERECHO	6875-H
		REPUESTO PARA SOPORTE DE TORSIÓN FRONTAL SUPERIOR IZQUIERDO Y DERECHO (7172)	7172-9
		SOPORTE PARA TRANSMISIÓN	7239-H
		SOPORTE PARA MOTOR FRONTAL SUPERIOR IZQUIERDO Y DERECHO	7484
V8 4.4 V8 5.0 V8 5.7	73-85	SOPORTE PARA MOTOR IZQUIERDO Y DERECHO	1782
SOPORTE PARA TRANSMISIÓN AUT.		1757	
SOPORTE PARA TRANSMISIÓN STD., 3 VEL.		1704	
V8 5.3	06-09	SOPORTE PARA MOTOR TRASERO	7475
		SOPORTE PARA MOTOR FRONTAL SUPERIOR IZQUIERDO Y DERECHO	7484
	06-10	REPUESTO PARA SOPORTE DE TORSIÓN FRONTAL SUPERIOR IZQUIERDO Y DERECHO (7172)	7172-9



CONTINUACIÓN... IMPALA

28	APLICACIÓN / DESCRIPTION	DAI PARTS #	DAI KIT PARTS #
BASES PARA AMORTIGUADOR / STRUT MOUNTS			
00-11	BASE PARA AMORTIGUADOR FRONTAL IZQUIERDA Y DERECHA		7222-KIT
00-05	BASE PARA AMORTIGUADOR TRASERA IZQUIERDA		7285-KIT
	BASE PARA AMORTIGUADOR TRASERA DERECHA		7296-KIT



28	APLICACIÓN / DESCRIPTION	DAI PARTS #
MISCELÁNEOS / AUTOMOTIVE RUBBER PARTS		
49-57	TORNILLO ESTABILIZADOR (6", 177.8 mm)	6101
	TORNILLO ESTABILIZADOR (6", 177.8 mm EQUIPO ORIGINAL)	6105
58-70	TORNILLO ESTABILIZADOR (5", 154.2 mm)	6100
	TORNILLO ESTABILIZADOR (5", 154.2 mm EQUIPO ORIGINAL)	6104
71-07	TORNILLO ESTABILIZADOR (7", 203.2 mm)	6102
71-07	TORNILLO ESTABILIZADOR (7", 203.2 mm EQUIPO ORIGINAL)	6106
00-11	BUJE PARA HORQUILLA GRANDE	DAI-1403005
	BUJE PARA HORQUILLA CHICO	DAI-1403006

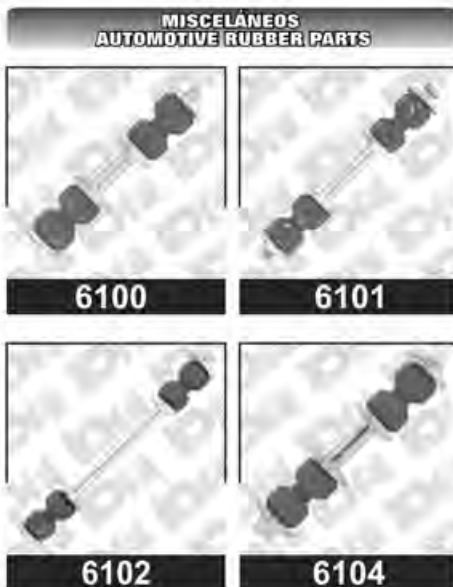

IMPALA SS

 		APLICACIÓN / DESCRIPTION	DAI PARTS #
SOPORTES / TRANSMISSION & MOTOR MOUNTS			
83-96		TORNILLO ESTABILIZADOR (7", 203.2 mm)	6102
		TORNILLO ESTABILIZADOR (7", 203.2 mm EQUIPO ORIGINAL)	6106



INTRIGUE

SOPORTES / TRANSMISSION & MOTOR MOUNTS			
V6 3.5	99-02	REPUESTO PARA SOPORTE DE TORSIÓN FRONTAL SUPERIOR IZQUIERDO Y DERECHO 7172	7172-9
		SOPORTE PARA TRANSMISIÓN	7239-H
		SOPORTE PARA MOTOR FRONTAL SUPERIOR IZQUIERDO Y DERECHO	7362
		SOPORTE PARA MOTOR FRONTAL	7483-H
V6 3.8	99-02	SOPORTE PARA MOTOR FRONTAL SUPERIOR IZQUIERDO Y DERECHO	7362
V6 5.3	99-02	SOPORTE PARA MOTOR TRASERO	7475



JIMMY

SOPORTES / TRANSMISSION & MOTOR MOUNTS			
L4 1.9	1982	SOPORTE PARA MOTOR IZQUIERDO Y DERECHO	6771
	83-84	SOPORTE PARA TRANSMISIÓN (4X4)	6874



CONTINUACIÓN... JIMMY

	 28	APLICACIÓN // DESCRIPTION	DAI PARTS #
SOPORTES / TRANSMISSION & MOTOR MOUNTS			
L4 1.9	1984	SOPORTE PARA TRANSMISIÓN	1911
		SOPORTE PARA TRANSMISIÓN	1940
L4 2.0	83-84	SOPORTE PARA TRANSMISIÓN (4X4)	6874
		SOPORTE PARA TRANSMISIÓN	1911
		SOPORTE PARA TRANSMISIÓN	1940
L4 2.2	83-85	SOPORTE PARA TRANSMISIÓN	1911
		SOPORTE PARA TRANSMISIÓN	1940
L4 2.5	85-87	SOPORTE PARA TRANSMISIÓN	1911
		SOPORTE PARA TRANSMISIÓN	1940
	85-93	SOPORTE PARA TRANSMISIÓN (4X4)	6874
	88-93	SOPORTE PARA TRANSMISIÓN	6774
V6 2.8	82-93	SOPORTE PARA TRANSMISIÓN (4X4)	6874
		SOPORTE PARA TRANSMISIÓN	1911
	83-87	SOPORTE PARA TRANSMISIÓN	1940
		88-93	SOPORTE PARA TRANSMISIÓN
V6 4.3	88-94	SOPORTE PARA TRANSMISIÓN	6774
	95-05	SOPORTE PARA TRANSMISIÓN	1911
		SOPORTE PARA TRANSMISIÓN	1940

**SOPORTES
TRANSMISSION & MOTOR MOUNTS**

1911

1940

6774

6874
MISCELÁNEOS / AUTOMOTIVE RUBBER PARTS

	83-04	GOMA PARA BARRA ESTABILIZADORA (4X4)	6065
		BUJES PARA HORQUILLA SUPERIOR (4X4)	DAI-K-6283

**MISCELÁNEOS
AUTOMOTIVE RUBBER PARTS**

6065

DAI-K-6283

LUMINA

 		APLICACIÓN / DESCRIPTION	DAI PARTS #
SOPORTES / TRANSMISSION & MOTOR MOUNTS			
L4 2.2	1993	REPUESTO PARA SOPORTE PARA MOTOR DERECHO	6837-9
		REPUESTO PARA SOPORTE PARA MOTOR DERECHO	6837-H
L4 2.5	90-94	SOPORTE PARA MOTOR DERECHO	6838-H
		SOPORTE PARA MOTOR DERECHO	6875-H
		SOPORTE DE TORSIÓN FRONTAL SUPERIOR	6781
		SOPORTE PARA TRANSMISIÓN	6920
V6 3.1	90-01	SOPORTE PARA MOTOR DERECHO	6838-H
		SOPORTE PARA MOTOR DERECHO	6875-H
	90-94	SOPORTE DE TORSIÓN FRONTAL SUPERIOR	6781
		SOPORTE PARA TRANSMISIÓN	6920
	95-01	SOPORTE PARA MOTOR FRONTAL SUPERIOR IZQUIERDO Y DERECHO	7166
		REPUESTO PARA SOPORTE DE TORSIÓN FRONTAL SUPERIOR IZQUIERDO Y DERECHO (7172)	7172-9
SOPORTE PARA TRANSMISIÓN AUT., 4 VEL.		7239-H	
V6 3.4	91-97	SOPORTE PARA MOTOR DERECHO	6918-H
		SOPORTE PARA TRANSMISIÓN AUT., 4 VEL.	7239-H
	92-96	SOPORTE PARA TRANSMISIÓN AUT., 4 VEL.	6920
V6 3.8	98-99	SOPORTE PARA MOTOR FRONTAL SUPERIOR IZQUIERDO Y DERECHO	7166
		SOPORTE PARA MOTOR DERECHO	6875-H

**SOPORTES
TRANSMISSION & MOTOR MOUNTS**

	
6781	6837-9
	
6837-H	6838-H
	
6875-H	6918-H
	
6920	7166
	
7172-9	7239-H



CONTINUACIÓN... LUMINA

  28		APLICACIÓN / DESCRIPTION	DAI PARTS #
SOPORTES / TRANSMISSION & MOTOR MOUNTS			
V6 3.8	98-99	REPUESTO PARA SOPORTE DE TORSIÓN FRONTAL SUPERIOR IZQUIERDO Y DERECHO (7172)	7172-9
		SOPORTE PARA TRANSMISIÓN AUT., 4 VEL.	7239-H
		SOPORTE PARA MOTOR DERECHO	6838-H



  28		APLICACIÓN / DESCRIPTION	DAI PARTS #	DAI KIT PARTS #
BASES PARA AMORTIGUADOR / STRUT MOUNTS				
90-01		BASE PARA AMORTIGUADOR FRONTAL IZQUIERDA Y DERECHA	6720	6720-KIT
		BASE PARA AMORTIGUADOR TRASERA IZQUIERDA Y DERECHA	6735	6735-KIT



LUMINA APV

28		APLICACIÓN / DESCRIPTION	DAI PARTS #	DAI KIT PARTS #
BASES PARA AMORTIGUADOR / STRUT MOUNTS				
88-96		BASE PARA AMORTIGUADOR TRASERA IZQUIERDA Y DERECHA	1821	1821-KIT
		BASE PARA AMORTIGUADOR FRONTAL IZQUIERDA Y DERECHA	6666	6666-KIT
		BASE PARA AMORTIGUADOR FRONTAL IZQUIERDA Y DERECHA	6667	6667-KIT



LUMINA VAN

28		APLICACIÓN / DESCRIPTION	DAI PARTS #	DAI KIT PARTS #
BASES PARA AMORTIGUADOR / STRUT MOUNTS				
89-96		BASE PARA AMORTIGUADOR TRASERA IZQUIERDA Y DERECHA	1821	1821-KIT



LUV

28		APLICACIÓN / DESCRIPTION	DAI PARTS #
SOPORTES / TRANSMISSION & MOTOR MOUNTS			
L4 2.2	97-05	SOPORTE PARA TRANSMISIÓN	7088
		SOPORTE PARA MOTOR IZQUIERDO Y DERECHO	7099



CONTINUACIÓN... LUV

 28		APLICACIÓN / DESCRIPTION	DAI PARTS #
MISCELÁNEOS / AUTOMOTIVE RUBBER PARTS			
72-80		TORNILLO ESTABILIZADOR (6", 177.8 mm)	6101
		TORNILLO ESTABILIZADOR (6", 177.8 mm EQUIPO ORIGINAL)	6105
73-08		COPE PARA DIRECCIÓN (SINFÍN DE .625" NO REQUIERE PERNOS)	617
		GALLETAS PARA DIRECCIÓN STD. Y HID. (NO REQUIERE PERNOS CON BUJES COMPLETO 617)	629
97-05		BUJE PARA MUELLE (POLIURETANO)	9126
		BUJE SUPERIOR	DAI-K-9468

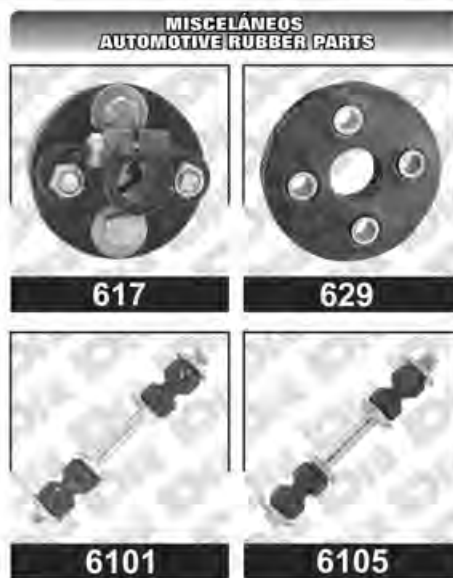
MALIBU

SOPORTES / TRANSMISSION & MOTOR MOUNTS			
L4 2.0	13-15	SOPORTE PARA MOTOR FRONTAL	7602
		SOPORTE PARA TRANSMISIÓN	7760-H
L4 2.4	13-15	SOPORTE PARA MOTOR DERECHO	7771-H
L4 2.5	2016		



CONTINUACIÓN... MALIBU

		APLICACIÓN / DESCRIPTION	DAI PARTS #
SOPORTES / TRANSMISSION & MOTOR MOUNTS			
L4 2.0	13-15	SOPORTE PARA MOTOR DERECHO	7772-H
L4 2.4			
L4 2.5			
L4 2.2	04-05	SOPORTE PARA TRANSMISIÓN CENTRAL CLASSIC	6979
		REPUESTO PARA SOPORTE FRONTAL Y TRASERO DE TRANSMISIÓN CLASSIC	6985
		SOPORTE PARA MOTOR DERECHO	7334-H
		SOPORTE PARA MOTOR DERECHO CLASSIC	7379-H
		SOPORTE PARA TRANSMISIÓN REPUESTO (6985)	7482
	04-08	SOPORTE PARA MOTOR FRONTAL	7400
07-10	SOPORTE PARA TRANSMISIÓN	7655	
L4 2.4	97-99	SOPORTE PARA TRANSMISIÓN CENTRAL CLASSIC	6979
		SOPORTE PARA MOTOR DERECHO CLASSIC	6980-H
		REPUESTO PARA SOPORTE FRONTAL Y TRASERO DE TRANSMISIÓN CLASSIC	6985
		REPUESTO PARA SOPORTE DE MOTOR FRONTAL Y TRASERO CLASSIC	7216-9
		SOPORTE PARA TRANSMISIÓN REPUESTO (6985)	7482

SOPORTES TRANSMISSION & MOTOR MOUNTS



6979 6980-H



6985 7216-9



7313 7334-H

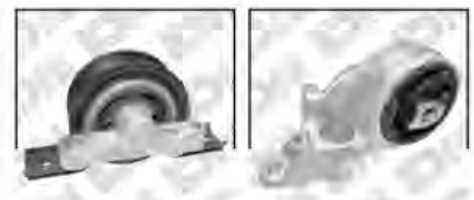

7379-H 7400



7482 7655



7772-H



CONTINUACIÓN... MALIBU

		APLICACIÓN / DESCRIPTION	DAI PARTS #
SOPORTES / TRANSMISSION & MOTOR MOUNTS			
L4 2.4	09-11	SOPORTE PARA MOTOR FRONTAL	7400
	09-12	SOPORTE PARA MOTOR DERECHO	7510-H
		SOPORTE PARA MOTOR FRONTAL AUT. 6 VEL.	7603
L4 2.4	13-14	SOPORTE PARA FRONTAL	7602
L4 2.5	13-15		
V6 3.1	97-98	SOPORTE PARA MOTOR FRONTAL DERECHO INFERIOR (BUJE LARGO 60.24 mm) <i>CLASSIC</i>	6936
	97-01	SOPORTE PARA MOTOR DERECHO <i>CLASSIC</i>	6980-H
	97-03	SOPORTE PARA TRANSMISIÓN CENTRAL <i>CLASSIC</i>	6979
	97-98	REPUESTO PARA SOPORTE DE MOTOR FRONTAL Y TRASERO <i>CLASSIC</i>	7216-9
	99-03	REPUESTO PARA SOPORTE FRONTAL Y TRASERO DE TRANSMISIÓN <i>CLASSIC</i>	6985
SOPORTE PARA TRANSMISIÓN REPUESTO (6985)		7482	
V6 3.3	1978	SOPORTE PARA MOTOR IZQUIERDO (1RA EDICIÓN) <i>CLASSIC</i>	6790
	78-83	SOPORTE PARA MOTOR DERECHO <i>CLASSIC</i>	6791
	1979	SOPORTE PARA TRANSMISIÓN <i>CLASSIC</i>	6774

**SOPORTES
TRANSMISSION & MOTOR MOUNTS**

6774

6790

6791

6936

6979

6980-H

6985

7216-9

7400

7482

7510-H

7602

7603

CONTINUACIÓN... MALIBU

			APLICACIÓN / DESCRIPTION	DAI PARTS #
SOPORTES / TRANSMISSION & MOTOR MOUNTS				
V6 3.5	04-08		SOPORTE PARA TRANSMISIÓN	7655
	04-12		SOPORTE PARA TRANSMISIÓN	7562-H
				SOPORTE PARA MOTOR DERECHO
V6 3.6	09-12		SOPORTE PARA TRANSMISIÓN	7562-H
				SOPORTE PARA MOTOR DERECHO
V6 3.8	1979		SOPORTE PARA TRANSMISIÓN CLASSIC	6774
	78-83		SOPORTE PARA TRANSMISIÓN CLASSIC	6770
				SOPORTE PARA MOTOR DERECHO CLASSIC
	80-83		SOPORTE PARA MOTOR IZQUIERDO Y DERECHO CLASSIC	6640
V6 3.9	06-08		SOPORTE PARA TRANSMISIÓN	7562-H
				SOPORTE PARA MOTOR DERECHO

**SOPORTES
TRANSMISSION & MOTOR MOUNTS**



6640



6770



6774



6791



7562-H



7563-H



7655

	APLICACIÓN / DESCRIPTION	DAI PARTS #	DAI KIT PARTS #
BASES PARA AMORTIGUADOR / STRUT MOUNTS			
97-05	BASE PARA AMORTIGUADOR FRONTAL IZQUIERDA Y DERECHA		6986-KIT

**BASES PARA AMORTIGUADOR
STRUT MOUNTS**



6986-KIT



CONTINUACIÓN... MALIBU

28	APLICACIÓN / DESCRIPTION	DAI PARTS #	DAI KIT PARTS #
BASES PARA AMORTIGUADOR / STRUT MOUNTS			
97-05	BASE PARA AMORTIGUADOR TRASERA IZQUIERDA Y DERECHA		7328-KIT

**BASES PARA AMORTIGUADOR
STRUT MOUNTS**

7328-KIT

28	APLICACIÓN / DESCRIPTION	DAI PARTS #
CUBRE POLVOS / C.V. BOOTS		
L4 2.2	97-04 CUBRE POLVO IZQUIERDO Y DERECHO DE DIRECCIÓN HID.	6381
L4 2.4	04-10 CUBRE POLVO IZQUIERDO Y DERECHO LADO RUEDA	63128

**CUBRE POLVO
C.V. BOOTS**

6381

63128

MISCELÁNEOS / AUTOMOTIVE RUBBER PARTS			
73-88	TORNILLO ESTABILIZADOR (7", 203.2 mm)	6102	
	TORNILLO ESTABILIZADOR (7", 203.2 mm EQUIPO ORIGINAL)	6106	
97-03	GOMA PARA BARRA ESTABILIZADORA	6404	
	BUJES PARA HORQUILLA	DAI-K-6578	
97-05	GOMA PARA BARRA ESTABILIZADORA 5/8"	64697	
	GOMA PARA BARRA ESTABILIZADORA 7/8"	64707	
97-12	TOPE PARA AMORTIGUADOR FRONTAL IZQUIERDO Y DERECHO	D-0619	

**MISCELÁNEOS
AUTOMOTIVE RUBBER PARTS**

D-0619

6102

6106



6404

64697

64707

DAI-K-6578

CONTINUACIÓN... MALIBU

 		APLICACIÓN / DESCRIPTION	DAI PARTS #
MISCELÁNEOS / AUTOMOTIVE RUBBER PARTS			
04-12		TORNILLO ESTABILIZADOR FRONTAL	DAI-2103001
		BUJE PARA HORQUILLA INFERIOR CHICO	DAI-352364

**MISCELÁNEOS
AUTOMOTIVE RUBBER PARTS**



DAI-2103001



DAI-352364

MATIZ

SOPORTES / TRANSMISSION & MOTOR MOUNTS			
L4 1.0	04-05	SOPORTE PARA TRANSMISIÓN STD.	7146
		SOPORTE PARA MOTOR TRASERO	7148
		SOPORTE PARA MOTOR TRASERO	7662
	06-15	SOPORTE PARA TRANSMISIÓN STD.	7149
		SOPORTE PARA MOTOR TRASERO	7280
		SOPORTE PARA MOTOR DERECHO	7652

**SOPORTES
TRANSMISSION & MOTOR MOUNTS**



7146



7148



7149



7280



7652



7662

		APLICACIÓN / DESCRIPTION	DAI PARTS #	DAI KIT PARTS #
BASES PARA AMORTIGUADOR / STRUT MOUNTS				
04-09		BASE PARA AMORTIGUADOR FRONTAL IZQUIERDA Y DERECHA	7147	

**BASES PARA AMORTIGUADOR
STRUT MOUNTS**



7147



CONTINUACIÓN... MATIZ

28	APLICACIÓN / DESCRIPTION	DAI PARTS #	DAI KIT PARTS #
BASES PARA AMORTIGUADOR / STRUT MOUNTS			
06-15	BASE PARA AMORTIGUADOR FRONTAL IZQUIERDA Y DERECHA		7521-KIT

**BASES PARA AMORTIGUADOR
STRUT MOUNTS**

7521-KIT

28	APLICACIÓN / DESCRIPTION	DAI PARTS #
CUBRE POLVOS / C.V. BOOTS		
04-05	CUBRE POLVO IZQUIERDO Y DERECHO LADO RUEDA	6346
	CUBRE POLVO IZQUIERDO Y DERECHO DE DIRECCIÓN	63109
	CUBRE POLVO IZQUIERDO Y DERECHO LADO CAJA	63137

**CUBRE POLVO
C.V. BOOTS**

6346

63109

63137

MISCELÁNEOS / AUTOMOTIVE RUBBER PARTS		
04-09	GOMA PARA BARRA ESTABILIZADORA	64738
	BUJE PARA HORQUILLA	64814

**MISCELÁNEOS
AUTOMOTIVE RUBBER PARTS**

64738

64814



MERIVA

 		APLICACIÓN / DESCRIPTION	DAI PARTS #
SOPORTES / TRANSMISSION & MOTOR MOUNTS			
L4 1.8	04-08	SOPORTE PARA MOTOR TRASERO EASY TRONIC Y STD. (COMPLEMENTO 7075)	7074
		SOPORTE PARA MOTOR TRASERO EASY TRONIC Y STD. (COMPLEMENTO 7074)	7075
		SOPORTE PARA TRANSMISIÓN EASY TRONIC Y STD.	7076-H
		SOPORTE PARA MOTOR DERECHO EASY TRONIC Y STD.	7077
		SOPORTE PARA MOTOR FRONTAL EASY TRONIC Y STD.	7086



	APLICACIÓN / DESCRIPTION	DAI PARTS #	DAI KIT PARTS #
BASES PARA AMORTIGUADOR / STRUT MOUNTS			
04-08	BASE PARA AMORTIGUADOR FRONTAL IZQUIERDA Y DERECHA	1997	



 		APLICACIÓN / DESCRIPTION	DAI PARTS #
CUBRE POLVOS / C.V. BOOTS			
	04-08	CUBRE POLVO IZQUIERDO Y DERECHO LADO RUEDA	6380
		CUBRE POLVO IZQUIERDO Y DERECHO LADO RUEDA	63107



CONTINUACIÓN... MERIVA

		APLICACIÓN / DESCRIPTION	DAI PARTS #
CUBRE POLVOS / C.V. BOOTS			
04-08	CUBRE POLVO IZQUIERDO Y DERECHO LADO CAJA		63108
	CUBRE POLVO IZQUIERDO Y DERECHO CAJA DE DIRECCIÓN		63109
	CUBRE POLVO IZQUIERDO Y DERECHO LADO CAJA		63115



MISCELÁNEOS / AUTOMOTIVE RUBBER PARTS		
04-08	TOPE PARA AMORTIGUADOR FRONTAL IZQUIERDO Y DERECHO	D-037
	GOMA PARA BARRA ESTABILIZADORA	64718
	BUJE PARA HORQUILLA INFERIOR CHICO	DAI-1403007
	BUJE PARA HORQUILLA INFERIOR CHICO (REFORZADO)	DAI-1403007 R
	TORNILLO ESTABILIZADOR FRONTAL	DAI-2103001



DAI-1403007

DAI-1403007 R

DAI-2103001



MICROBUS

 		APLICACIÓN / DESCRIPTION	DAI PARTS #
SOPORTES / TRANSMISSION & MOTOR MOUNTS			
L6 4.8	80-94	SOPORTE PARA MOTOR IZQUIERDO Y DERECHO	1782
		SOPORTE PARA MOTOR IZQUIERDO	1913



MISCELÁNEOS / AUTOMOTIVE RUBBER PARTS		
		GOMA PARA BARRA ESTABILIZADORA (CON ABRAZADERA) 1887
		GOMA PARA BARRA ESTABILIZADORA (SIN ABRAZADERA) 1887-9
		GOMA PARA BARRA ESTABILIZADORA (POLIURETANO) 9087



MONTECARLO

SOPORTES / TRANSMISSION & MOTOR MOUNTS		
V6 3.1	95-99	SOPORTE PARA MOTOR DERECHO 6838-H
		SOPORTE PARA MOTOR DERECHO 6875-H
		SOPORTE PARA MOTOR FRONTAL SUPERIOR IZQUIERDO Y DERECHO 7166



CONTINUACIÓN... MONTECARLO

 		APLICACIÓN / DESCRIPTION	DAI PARTS #
SOPORTES / TRANSMISSION & MOTOR MOUNTS			
V6 3.1	95-99	REPUESTO PARA SOPORTE DE TORSIÓN FRONTAL SUPERIOR IZQUIERDO Y DERECHO (7172)	7172-9
		SOPORTE PARA TRANSMISIÓN	7239-H
V6 3.3	1987	SOPORTE PARA MOTOR IZQUIERDO	6790
	78-87	SOPORTE PARA TRANSMISIÓN	6770
		SOPORTE PARA MOTOR DERECHO	6791
V6 3.4	95-97	SOPORTE PARA MOTOR DERECHO	6918-H
	95-05	SOPORTE PARA TRANSMISIÓN	7239-H
	00-05	SOPORTE PARA MOTOR FRONTAL SUPERIOR IZQUIERDO Y DERECHO	7166
		SOPORTE PARA MOTOR DERECHO	6838-H
		REPUESTO PARA SOPORTE DE TORSIÓN FRONTAL SUPERIOR IZQUIERDO Y DERECHO (7172)	7172-9
V6 3.5	06-07	SOPORTE PARA TRANSMISIÓN	6844
		SOPORTE PARA MOTOR FRONTAL SUPERIOR IZQUIERDO Y DERECHO	7484
		SOPORTE PARA MOTOR DERECHO	6838-H
		REPUESTO PARA SOPORTE DE TORSIÓN FRONTAL SUPERIOR IZQUIERDO Y DERECHO (7172)	7172-9
V6 3.8	78-87	SOPORTE PARA TRANSMISIÓN	6770
		SOPORTE PARA MOTOR DERECHO	6791
	98-99	SOPORTE PARA MOTOR FRONTAL SUPERIOR IZQUIERDO Y DERECHO	7166
	98-05	SOPORTE PARA MOTOR DERECHO	6838-H
		REPUESTO PARA SOPORTE DE TORSIÓN FRONTAL SUPERIOR IZQUIERDO Y DERECHO (7172)	7172-9
		SOPORTE PARA TRANSMISIÓN	7239-H

**SOPORTES
TRANSMISSION & MOTOR MOUNTS**

6770

6790

6791

6838-H

6844

6918-H

7166

7172-9

7239-H

7484

CONTINUACIÓN... MONTECARLO

 		APLICACIÓN / DESCRIPTION	DAI PARTS #
SOPORTES / TRANSMISSION & MOTOR MOUNTS			
V6 3.8	00-05	SOPORTE PARA MOTOR FRONTAL SUPERIOR IZQUIERDO Y DERECHO	7362
V6 3.9	2006	SOPORTE PARA MOTOR FRONTAL SUPERIOR IZQUIERDO Y DERECHO	7484
		SOPORTE PARA MOTOR DERECHO	6838-H
	06-07	REPUESTO PARA SOPORTE DE TORSIÓN FRONTAL SUPERIOR IZQUIERDO Y DERECHO (7172)	7172-9
		SOPORTE PARA TRANSMISIÓN	7239-H
V6 5.3	06-07	REPUESTO PARA SOPORTE DE TORSIÓN FRONTAL SUPERIOR IZQUIERDO Y DERECHO (7172)	7172-9
		SOPORTE PARA MOTOR TRASERO	7475
		SOPORTE PARA MOTOR FRONTAL	7483-H



		APLICACIÓN / DESCRIPTION	DAI PARTS #	DAI KIT PARTS #
BASES PARA AMORTIGUADOR / STRUT MOUNTS				
95-99		BASE PARA AMORTIGUADOR FRONTAL IZQUIERDA Y DERECHA	6720	6720-KIT
00-07		BASE PARA AMORTIGUADOR FRONTAL IZQUIERDA Y DERECHA		7222-KIT



CONTINUACIÓN... MONTE CARLO

28	APLICACIÓN / DESCRIPTION	DAI PARTS #	DAI KIT PARTS #
BASES PARA AMORTIGUADOR / STRUT MOUNTS			
97-99	BASE PARA AMORTIGUADOR FRONTAL DERECHA		7285-KIT
	BASE PARA AMORTIGUADOR FRONTAL IZQUIERDA		7296-KIT



28	APLICACIÓN / DESCRIPTION	DAI PARTS #
MISCELÁNEOS / AUTOMOTIVE RUBBER PARTS		
73-88	TORNILLO ESTABILIZADOR (7", 203.2 mm)	6102
	TORNILLO ESTABILIZADOR (7", 203.2 mm EQUIPO ORIGINAL)	6106
00-07	BUJE PARA HORQUILLA GRANDE	DAI-1403005
	BUJE PARA HORQUILLA CHICO	DAI-1403006

NOVA

SOPORTES / TRANSMISSION & MOTOR MOUNTS		
62-74	TORNILLO EXCENTRICO	64600



OPTRA

  28		APLICACIÓN / DESCRIPTION	DAI PARTS #
SOPORTES / TRANSMISSION & MOTOR MOUNTS			
L4 2.0	06-10	SOPORTE PARA TRANSMISIÓN STD.	7150-H
		SOPORTE PARA MOTOR DERECHO	7157-H
		SOPORTE PARA MOTOR DERECHO SUPERIOR	7158
		SOPORTE PARA MOTOR DERECHO INFERIOR	7429



 28	APLICACIÓN / DESCRIPTION	DAI PARTS #	DAI KIT PARTS #
BASES PARA AMORTIGUADOR / STRUT MOUNTS			
06-10	BASE PARA AMORTIGUADOR FRONTAL IZQUIERDA Y DERECHA	7333	



  28		APLICACIÓN / DESCRIPTION	DAI PARTS #
MISCELÁNEOS / AUTOMOTIVE RUBBER PARTS			
	06-10	BUJE PARA HORQUILLA INFERIOR GRANDE	DAI-1403021
		TORNILLO ESTABILIZADOR TRASERO	DAI-2103011
		TORNILLO ESTABILIZADOR FRONTAL IZQUIERDO	DAI-2103013



PICK UP

 		APLICACIÓN / DESCRIPTION	DAI PARTS #
MISCELÁNEOS / AUTOMOTIVE RUBBER PARTS			
88-94		BUJES PARA HORQUILLA SUPERIOR (4X4) K1500	DAI-K-6323
		BUJES PARA HORQUILLA SUPERIOR (4X4) K2500 7200 LBS.	
		BUJES PARA HORQUILLA SUPERIOR (4X4) K2500 8600 LBS.	
		BUJES PARA HORQUILLA SUPERIOR (4X4) K3500	
88-99		BUJE PARA HORQUILLA SUPERIOR (4X4) K1500	DAI-K-6395
		BUJE PARA HORQUILLA SUPERIOR (4X4) K2500 7200 LBS.	
		BUJE PARA HORQUILLA SUPERIOR (4X4) K2500 8600 LBS.	
		BUJE PARA HORQUILLA SUPERIOR (4X4) K3500	





RAINIER

SOPORTES / TRANSMISSION & MOTOR MOUNTS			
L6 4.2	04-07	SOPORTE PARA MOTOR IZQUIERDO Y DERECHO	7244-H



S-10

			APLICACIÓN / DESCRIPTION	DAI PARTS #
SOPORTES / TRANSMISSION & MOTOR MOUNTS				
L4 1.9	82-85		SOPORTE PARA MOTOR IZQUIERDO Y DERECHO	6771
	83-84		SOPORTE PARA TRANSMISIÓN (4X4)	6874
	1984		SOPORTE PARA TRANSMISIÓN	1911
			SOPORTE PARA TRANSMISIÓN	1940
L4 2.0	83-84		SOPORTE PARA TRANSMISIÓN	1940
			SOPORTE PARA TRANSMISIÓN (4X4)	6874
			SOPORTE PARA TRANSMISIÓN (2X2)	1911
L4 2.2	83-85		SOPORTE PARA TRANSMISIÓN	1911
			SOPORTE PARA TRANSMISIÓN	1940
			SOPORTE PARA MOTOR IZQUIERDO	6909
			SOPORTE PARA MOTOR DERECHO	6983
	94-03		SOPORTE PARA MOTOR IZQUIERDO	7003
			SOPORTE PARA MOTOR DERECHO	7004
			SOPORTE PARA TRANSMISIÓN	7079
			REPUESTO PARA SOPORTE DE MOTOR IZQUIERDO Y DERECHO (7003 Y 7004)	7097
L4 2.5	85-87		SOPORTE PARA TRANSMISIÓN	1911
			SOPORTE PARA TRANSMISIÓN	1940
	88-93		SOPORTE PARA TRANSMISIÓN	6774
	85-93		SOPORTE PARA MOTOR IZQUIERDO	6909
			SOPORTE PARA MOTOR DERECHO	6983
			SOPORTE PARA TRANSMISIÓN (4X4)	6874



CONTINUACIÓN... S-10

	 28	APLICACIÓN / DESCRIPTION	DAI PARTS #
SOPORTES / TRANSMISSION & MOTOR MOUNTS			
V6 2.8	82-93	SOPORTE PARA MOTOR IZQUIERDO Y DERECHO	6640
		SOPORTE PARA TRANSMISIÓN	6774
		SOPORTE PARA TRANSMISIÓN (4X4)	6874
	83-87	SOPORTE PARA TRANSMISIÓN	1911
		SOPORTE PARA TRANSMISIÓN	1940
V6 4.3	88-94	SOPORTE PARA TRANSMISIÓN	6774
	88-95	SOPORTE PARA MOTOR IZQUIERDO	6873
	88-04	SOPORTE PARA TRANSMISIÓN (4X4)	6874
	95-04	SOPORTE PARA TRANSMISIÓN	6876
	95-05	SOPORTE PARA TRANSMISIÓN	1940
		SOPORTE PARA TRANSMISIÓN	1911
96-05	SOPORTE PARA MOTOR IZQUIERDO Y DERECHO	6914	

6876

6914

**SOPORTES
TRANSMISSION & MOTOR MOUNTS**



1911



1940



6640



6774



6873



6874

CUBRE POLVOS / C.V. BOOTS

97-04	CUBRE POLVO IZQUIERDO Y DERECHO LADO RUEDA (4x4 GRANDE)	6337
	CUBRE POLVO IZQUIERDO Y DERECHO LADO RUEDA (4X2)	6338

**CUBRE POLVO
C.V. BOOTS**





6337



6338



CONTINUACIÓN... S-10

	 28	APLICACIÓN / DESCRIPTION	DAI PARTS #
MISCELÁNEOS / AUTOMOTIVE RUBBER PARTS			
83-04		GOMA PARA BARRA ESTABILIZADORA (4X4)	6065
		BUJES PARA HORQUILLA SUPERIOR (4X4)	DAI-K-6283
84-04		TORNILLO ESTABILIZADOR (7", 203.200 mm)	6102
		TORNILLO ESTABILIZADOR (7", 203.200 mm EQUIPO ORIGINAL)	6106
88-00		GOMA PARA BARRA ESTABILIZADORA	64708
		TOPE PARA AMORTIGUADOR TRASERO IZQUIERDO Y DERECHO	D-142
91-08		COPLÉ PARA DIRECCIÓN STD. Y HID. COPLÉ CHICO 2 5/8" (SINFÍN DE .700" IMPORTADOS)	616
		GALLETA PARA DIRECCIÓN (4 PERNOS COPLÉ CHICO 2 5/8" COMPLETO 607 Y 617 NACIONALES Y AMERICANOS)	625

MISCELÁNEOS AUTOMOTIVE RUBBER PARTS

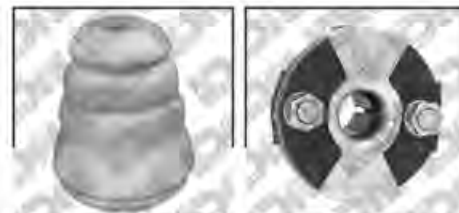

D-142 616

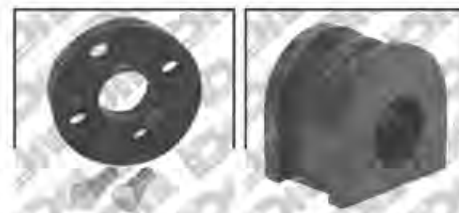

625 6065



6102 6106



64708 DAI-K-6283

S-15

SOPORTES / TRANSMISSION & MOTOR MOUNTS			
L4 1.9	82-85	SOPORTE PARA MOTOR IZQUIERDO Y DERECHO	6771
	83-84	SOPORTE PARA TRANSMISIÓN (4X4)	6874

SOPORTES TRANSMISSION & MOTOR MOUNTS



6874 6771



CONTINUACIÓN... S-15

	 28	APLICACIÓN / DESCRIPTION	DAI PARTS #
SOPORTES / TRANSMISSION & MOTOR MOUNTS			
L4 1.9	1984	SOPORTE PARA TRANSMISIÓN	1911
		SOPORTE PARA TRANSMISIÓN	1940
L4 2.0	83-84	SOPORTE PARA TRANSMISIÓN (4X4)	6874
		SOPORTE PARA TRANSMISIÓN	1911
		SOPORTE PARA TRANSMISIÓN	1940
L4 2.2	83-85	SOPORTE PARA MOTOR DERECHO	6983
		SOPORTE PARA MOTOR IZQUIERDO	6909
		SOPORTE PARA TRANSMISIÓN	1911
		SOPORTE PARA TRANSMISIÓN	1940
	94-03	REPUESTO PARA SOPORTE DE MOTOR IZQUIERDO Y DERECHO (7003 Y 7004)	7097
		SOPORTE PARA MOTOR IZQUIERDO	7003
		SOPORTE PARA MOTOR DERECHO	7004
	SOPORTE PARA TRANSMISIÓN	7079	
L4 2.5	85-93	SOPORTE PARA TRANSMISIÓN (4X4)	6874
		SOPORTE PARA MOTOR IZQUIERDO	6909
		SOPORTE PARA MOTOR DERECHO	6983
	88-93	SOPORTE PARA TRANSMISIÓN	6774
	85-87	SOPORTE PARA TRANSMISIÓN	1911
		SOPORTE PARA TRANSMISIÓN	1940
V6 2.8	82-93	SOPORTE PARA MOTOR IZQUIERDO Y DERECHO	6640

**SOPORTES
TRANSMISSION & MOTOR MOUNTS**

1911

1940

6640

6774

6874

6909

6983

7003

7004

7079

7097

CONTINUACIÓN... S-15

			APLICACIÓN / DESCRIPTION	DAI PARTS #
SOPORTES / TRANSMISSION & MOTOR MOUNTS				
V6 2.8	82-93	SOPORTE PARA TRANSMISIÓN		6774
		SOPORTE PARA TRANSMISIÓN (4X4)		6874
	83-87	SOPORTE PARA TRANSMISIÓN		1940
		SOPORTE PARA TRANSMISIÓN		1911
V6 4.3	88-04	SOPORTE PARA TRANSMISIÓN (4X4)		6874
	88-94	SOPORTE PARA TRANSMISIÓN		6774
	88-95	SOPORTE PARA MOTOR IZQUIERDO Y DERECHO		6873
	95-04	SOPORTE PARA TRANSMISIÓN		6876
	95-05	SOPORTE PARA TRANSMISIÓN		1940
		SOPORTE PARA TRANSMISIÓN		1911
	96-05	SOPORTE PARA MOTOR IZQUIERDO Y DERECHO		6914



MISCELÁNEOS / AUTOMOTIVE RUBBER PARTS			
	83-04	BUJES PARA HORQUILLA SUPERIOR (4X4)	DAI-K-6283
	91-08	COPLÉ PARA DIRECCIÓN HID. Y STD. COPLÉ CHICO 2 5/8" (SINFÍN DE .700" IMPORTADOS)	616



CONTINUACIÓN... S-15



 28	APLICACIÓN / DESCRIPTION	DAI PARTS #
MISCELÁNEOS / AUTOMOTIVE RUBBER PARTS		
91-08	GALLETA PARA DIRECCIÓN (4 PERNOS COPLÉ CHICO 2 5/8" COMPLETO 607 Y 617 NACIONALES Y AMERICANOS)	625

SAFARI

SOPORTES / TRANSMISSION & MOTOR MOUNTS			
L4 2.5	85-90	SOPORTE PARA TRANSMISIÓN	6774
		SOPORTE PARA MOTOR IZQUIERDO	6909
		SOPORTE PARA MOTOR DERECHO	6983
V6 4.3	85-90	SOPORTE PARA TRANSMISIÓN	6774
	85-95	SOPORTE PARA MOTOR IZQUIERDO Y DERECHO	6640
	91-93	SOPORTE PARA TRANSMISIÓN	6874
		SOPORTE PARA TRANSMISIÓN	6876
	94-05	SOPORTE PARA TRANSMISIÓN AUT., 4 VEL.	7470-H



CONTINUACIÓN... SAFARI

		APLICACIÓN / DESCRIPTION	DAI PARTS #
MISCELÁNEOS / AUTOMOTIVE RUBBER PARTS			
	90-05	BUJE PARA HORQUILLA SUPERIOR (4X4)	DAI-K-6395

**MISCELÁNEOS
AUTOMOTIVE RUBBER PARTS**



DAI-K-6395

SAVANA

SOPORTES / TRANSMISSION & MOTOR MOUNTS			
V6 4.3	96-02	SOPORTE PARA MOTOR IZQUIERDO Y DERECHO	1920
V8 4.8 V8 5.3 V8 6.0	03-13	SOPORTE PARA MOTOR IZQUIERDO Y DERECHO	7401
V8 5.0 V8 5.7 V8 6.5 V8 7.4 V8 8.1	96-02	SOPORTE PARA MOTOR IZQUIERDO Y DERECHO	1920
V8 4.8 V8 5.3 V8 6.0	03-14	SOPORTE PARA TRANSMISIÓN	7474

**SOPORTES
TRANSMISSION & MOTOR MOUNTS**



1920 **7401**



7474

MISCELÁNEOS / AUTOMOTIVE RUBBER PARTS			
	96-02	TORNILLO ESTABILIZADOR (10", 243 mm EQUIPO ORIGINAL) VAN	6107
	92-02	BUJES PARA HORQUILLA SUPERIOR 1500	DAI-K-6323
	96-06	BUJES PARA HORQUILLA SUPERIOR G2500	

**MISCELÁNEOS
AUTOMOTIVE RUBBER PARTS**



6107 **DAI-K-6323**



CONTINUACIÓN... SAVANA

		APLICACIÓN / DESCRIPTION	DAI PARTS #	MISCELÁNEOS AUTOMOTIVE RUBBER PARTS
MISCELÁNEOS / AUTOMOTIVE RUBBER PARTS				
	02-14	BUJE PARA HORQUILLA SUPERIOR <i>1500</i>	DAI-K-6395	
	96-14	BUJE PARA HORQUILLA SUPERIOR <i>3500, 2500, 7300, 7700, 8500, 8600 LBS.</i>		

DAI-K-6395

SERIES K

SOPORTES / TRANSMISSION & MOTOR MOUNTS		SOPORTES TRANSMISSION & MOTOR MOUNTS		
V8 5.0 V8 5.7	88-99	SOPORTE PARA MOTOR IZQUIERDO Y DERECHO	6931	
V8 7.5	79-99			

6931

SERIES K-10

SOPORTES / TRANSMISSION & MOTOR MOUNTS		SOPORTES TRANSMISSION & MOTOR MOUNTS		
V8 6.2	82-83	SOPORTE PARA MOTOR IZQUIERDO Y DERECHO (4X4)	6898	

6898



SERIES K-15

 		APLICACIÓN / DESCRIPTION	DAI PARTS #
SOPORTES / TRANSMISSION & MOTOR MOUNTS			
V8 6.2	82-83	SOPORTE PARA MOTOR IZQUIERDO Y DERECHO (4X4)	6898



SERIES P-20

SOPORTES / TRANSMISSION & MOTOR MOUNTS			
V8 5.7	69-98	SOPORTE PARA TRANSMISIÓN	6874



SERIES P-25

SOPORTES / TRANSMISSION & MOTOR MOUNTS			
V8 5.7	69-98	SOPORTE PARA TRANSMISIÓN	6874



SERIES P-30

28		APLICACIÓN / DESCRIPTION	DAI PARTS #
SOPORTES / TRANSMISSION & MOTOR MOUNTS			
V8 5.7	69-98	SOPORTE PARA TRANSMISIÓN (4x4)	6874

**SOPORTES
TRANSMISSION & MOTOR MOUNTS**

6874
SERIES P-35

SOPORTES / TRANSMISSION & MOTOR MOUNTS			
V8 5.7	69-98	SOPORTE PARA TRANSMISIÓN (4x4)	6874

**SOPORTES
TRANSMISSION & MOTOR MOUNTS**

6874
SERIES T-10

SOPORTES / TRANSMISSION & MOTOR MOUNTS			
L4 2.0	85-90	SOPORTE PARA MOTOR IZQUIERDO Y DERECHO	6873
L4 2.8			
V6 4.3		SOPORTE PARA TRANSMISIÓN (4x4)	6874

**SOPORTES
TRANSMISSION & MOTOR MOUNTS**

6873

6874

SIERRA

 		APLICACIÓN / DESCRIPTION	DAI PARTS #
SOPORTES / TRANSMISSION & MOTOR MOUNTS			
V6 4.3	99-11	SOPORTE PARA TRANSMISIÓN	1911
		SOPORTE PARA TRANSMISIÓN	1940
	07-10	SOPORTE PARA MOTOR IZQUIERDO Y DERECHO 1500	7392
		SOPORTE PARA TRANSMISIÓN (4X4)	6874
	99-07	SOPORTE PARA MOTOR IZQUIERDO Y DERECHO 1500	7391
V8 4.8	99-11	SOPORTE PARA TRANSMISIÓN	1911
	99-09	SOPORTE PARA MOTOR IZQUIERDO Y DERECHO	7120
	99-11	SOPORTE PARA TRANSMISIÓN	1940
		SOPORTE PARA TRANSMISIÓN (4X4)	6874
	07-12	SOPORTE PARA MOTOR IZQUIERDO Y DERECHO	7365-H
	99-11	SOPORTE PARA TRANSMISIÓN	1911
V8 4.8	07-13	SOPORTE PARA MOTOR IZQUIERDO Y DERECHO 1500	7697
V8 5.3	99-11	SOPORTE PARA TRANSMISIÓN	1911
		SOPORTE PARA TRANSMISIÓN	1940
		SOPORTE PARA TRANSMISIÓN (4X4)	6874
	99-09	SOPORTE PARA MOTOR IZQUIERDO Y DERECHO	7120
	07-12	SOPORTE PARA MOTOR IZQUIERDO Y DERECHO	7365-H
V8 5.3	14-16	SOPORTE PARA MOTOR DERECHO	7638-H
V8 6.2		1500	

**SOPORTES
TRANSMISSION & MOTOR MOUNTS**



1911



1940



6874



7120



7365-H



7391



7392



7638-H



7697



CONTINUACIÓN... SIERRA

 		APLICACIÓN / DESCRIPTION	DAI PARTS #
SOPORTES / TRANSMISSION & MOTOR MOUNTS			
V8 6.0	99-11	SOPORTE PARA TRANSMISIÓN	1911
		SOPORTE PARA TRANSMISIÓN	1940
		SOPORTE PARA TRANSMISIÓN (4X4)	6874
	99-09	SOPORTE PARA MOTOR IZQUIERDO Y DERECHO	7120
	11-17	SOPORTE PARA MOTOR IZQUIERDO Y DERECHO 2500	7798
V8 6.0 V6 6.2	07-12	SOPORTE PARA MOTOR IZQUIERDO Y DERECHO	7365-H
V8 6.6	07-10	SOPORTE PARA MOTOR IZQUIERDO Y DERECHO HEVY DUTY	7128
	07-13	SOPORTE PARA MOTOR IZQUIERDO Y DERECHO	7401
	15-16	SOPORTE PARA MOTOR IZQUIERDO Y DERECHO 2500	7798
	01-10	SOPORTE PARA BARRA DE TORSION 1500	7548

**SOPORTES
TRANSMISSION & MOTOR MOUNTS**

1911

1940

6874

7120

7128

7365-H

7401

7548



7798

		APLICACIÓN / DESCRIPTION	DAI PARTS #	DAI KIT PARTS #
BASES PARA AMORTIGUADOR / STRUT MOUNTS				
07-12		BASE PARA AMORTIGUADOR FRONTAL IZQUIERDA Y DERECHA 1500		7356-KIT

**BASES PARA AMORTIGUADOR
STRUT MOUNTS**

7356-KIT

CONTINUACIÓN... SIERRA

 		APLICACIÓN / DESCRIPTION	DAI PARTS #
MISCELÁNEOS / AUTOMOTIVE RUBBER PARTS			
	00-14	BUJE PARA HORQUILLA SUPERIOR 1500	DAI-K-6395
	00-06	BUJE PARA HORQUILLA SUPERIOR 2500	

**MISCELÁNEOS
AUTOMOTIVE RUBBER PARTS**



DAI-K-6395

SILVERADO

SOPORTES / TRANSMISSION & MOTOR MOUNTS			
V6 4.3	99-11	SOPORTE PARA TRANSMISIÓN 1500	1911
		SOPORTE PARA TRANSMISIÓN 1500	1940
	99-07	SOPORTE PARA TRANSMISIÓN (4X4) 1500	6874
		SOPORTE PARA MOTOR IZQUIERDO Y DERECHO 1500	7391
	07-10	SOPORTE PARA MOTOR IZQUIERDO Y DERECHO 1500	7392
V8 4.8	07-13	SOPORTE PARA MOTOR IZQUIERDO Y DERECHO 1500	7697
V8 4.8 V8 5.3 V8 6.0	99-11	SOPORTE PARA TRANSMISIÓN 1500, 2500 Y 3500	1911
		SOPORTE PARA TRANSMISIÓN 1500	1940
		SOPORTE PARA TRANSMISIÓN (4X4) 1500	6874

**SOPORTES
TRANSMISSION & MOTOR MOUNTS**



1911



1940



6874



7391



7392



7697



CONTINUACIÓN... SILVERADO

 		APLICACIÓN / DESCRIPTION	DAI PARTS #
SOPORTES / TRANSMISSION & MOTOR MOUNTS			
V8 4.8 V8 5.3 V8 6.0	99-09	SOPORTE PARA MOTOR IZQUIERDO Y DERECHO <i>1500, 2500 Y 3500</i>	7120
	07-12	SOPORTE PARA MOTOR IZQUIERDO Y DERECHO <i>1500, 2500 Y 3500</i>	7365-H
V8 5.3 V8 6.2	15-18	SOPORTE PARA MOTOR DERECHO <i>1500</i>	7638-H
V8 6.2	07-12	SOPORTE PARA MOTOR IZQUIERDO Y DERECHO <i>1500, 2500 Y 3500</i>	7365-H
V8 6.6	07-10	SOPORTE PARA MOTOR IZQUIERDO Y DERECHO HEAVY DUTY <i>1500, 2500 Y 3500</i>	7128
	07-13	SOPORTE PARA MOTOR IZQUIERDO Y DERECHO <i>1500, 2500 Y 3500</i>	7401
V8 6.0 V8 6.8	11-17 15-16	SOPORTE PARA MOTOR IZQUIERDO Y DERECHO <i>2500</i>	7798
	01-10	SOPORTE PARA BARRA DE TORSION <i>1500</i>	7548

**SOPORTES
TRANSMISSION & MOTOR MOUNTS**

7120

7128

7365-H

7401

7548

7638-H



7798

	APLICACIÓN / DESCRIPTION	DAI PARTS #	DAI KIT PARTS #
BASES PARA AMORTIGUADOR / STRUT MOUNTS			
07-12	BASE PARA AMORTIGUADOR FRONTAL IZQUIERDA Y DERECHA <i>PICK UP, 1500, 2500</i>		7356-KIT

**BASES PARA AMORTIGUADOR
STRUT MOUNTS**

7356-KIT

CONTINUACIÓN... SILVERADO

 		APLICACIÓN / DESCRIPTION	DAI PARTS #
MISCELÁNEOS / AUTOMOTIVE RUBBER PARTS			
	00-14	BUJE PARA HORQUILLA SUPERIOR 1500 (4x4)	DAI-K-6395
	00-06	BUJE PARA HORQUILLA SUPERIOR 2500	

**MISCELÁNEOS
AUTOMOTIVE RUBBER PARTS**



DAI-K-6395

SONIC

SOPORTES / TRANSMISSION & MOTOR MOUNTS			
L4 1.6	11-17	SOPORTE PARA TRANSMISIÓN AUT.	7497-H
		SOPORTE PARA TRANSMISIÓN STD.	7496-H
		SOPORTE PARA MOTOR DERECHO	7498
		SOPORTE PARA MOTOR TRASERO	7499
		COMPLEMENTO PARA SOPORTE DE MOTOR TRASERO AUT. (7499)	7555
		COMPLEMENTO PARA SOPORTE DE MOTOR TRASERO STD. (7499)	7556

**SOPORTES
TRANSMISSION & MOTOR MOUNTS**



7496-H

7497-H

7498

7499



7555

7556

SONOMA

SOPORTES / TRANSMISSION & MOTOR MOUNTS			
L4 1.9	82-85	SOPORTE PARA TRANSMISIÓN (4X4)	6874
	84-85	SOPORTE PARA TRANSMISIÓN	1911

**SOPORTES
TRANSMISSION & MOTOR MOUNTS**





1911

6874



CONTINUACIÓN... SONOMA

	 28	APLICACIÓN / DESCRIPTION	DAI PARTS #
SOPORTES / TRANSMISSION & MOTOR MOUNTS			
L4 1.9	84-85	SOPORTE PARA TRANSMISIÓN	1940
L4 2.0	83-84	SOPORTE PARA TRANSMISIÓN (4X4)	6874
		SOPORTE PARA TRANSMISIÓN	1911
		SOPORTE PARA TRANSMISIÓN	1940
L4 2.2	83-85	SOPORTE PARA TRANSMISIÓN	1911
		SOPORTE PARA TRANSMISIÓN	1940
L4 2.5	88-93	SOPORTE PARA TRANSMISIÓN	6774
	85-90	SOPORTE PARA TRANSMISIÓN (4X4)	6874
	85-87	SOPORTE PARA TRANSMISIÓN	1911
		SOPORTE PARA TRANSMISIÓN	1940
V6 2.8	83-87	SOPORTE PARA TRANSMISIÓN	1911
		SOPORTE PARA TRANSMISIÓN	1940
	82-93	SOPORTE PARA TRANSMISIÓN (4X4)	6874
V8 4.3	88-94	SOPORTE PARA TRANSMISIÓN	6774
	88-04	SOPORTE PARA TRANSMISIÓN (4X4)	6874
	95-04	SOPORTE PARA TRANSMISIÓN	6876

**SOPORTES
TRANSMISSION & MOTOR MOUNTS**

1911

1940

6774

6874

6876
MISCELÁNEOS / AUTOMOTIVE RUBBER PARTS

	83-04	GOMA PARA BARRA ESTABILIZADORA (4X4)	6065
		BUJES PARA HORQUILLA SUPERIOR (4X4)	DAI-K-6283

**MISCELÁNEOS
AUTOMOTIVE RUBBER PARTS**

6065

DAI-K-6283

SONORA

			APLICACIÓN / DESCRIPTION	DAI PARTS #
SOPORTES / TRANSMISSION & MOTOR MOUNTS				
V6 4.3	07-10	SOPORTE PARA MOTOR IZQUIERDO Y DERECHO		7392
	07-11	SOPORTE PARA TRANSMISIÓN		1911
		SOPORTE PARA TRANSMISIÓN		1940
V8 4.8	00-11	SOPORTE PARA TRANSMISIÓN		1911
		SOPORTE PARA TRANSMISIÓN		1940
		SOPORTE PARA TRANSMISIÓN (4X4)		6874
	00-07	SOPORTE PARA MOTOR IZQUIERDO Y DERECHO		7120
07-12	SOPORTE PARA MOTOR IZQUIERDO Y DERECHO		7365-H	
V8 5.3	00-11	SOPORTE PARA TRANSMISIÓN		1911
	00-07	SOPORTE PARA MOTOR IZQUIERDO Y DERECHO		7120
	00-11	SOPORTE PARA TRANSMISIÓN		1940
		SOPORTE PARA TRANSMISIÓN (4X4)		6874
	07-12	SOPORTE PARA MOTOR IZQUIERDO Y DERECHO		7365-H
V8 5.7	92-00	SOPORTE PARA TRANSMISIÓN (4X4)		6874
		SOPORTE PARA MOTOR IZQUIERDO Y DERECHO		6931
	92-99	SOPORTE PARA MOTOR IZQUIERDO Y DERECHO		1920
	00-07	SOPORTE PARA MOTOR IZQUIERDO Y DERECHO		7120
V8 6.0	01-11	SOPORTE PARA TRANSMISIÓN		1940
		SOPORTE PARA TRANSMISIÓN (4X4)		6874
		SOPORTE PARA TRANSMISIÓN		1911
	01-07	SOPORTE PARA MOTOR IZQUIERDO Y DERECHO		7120
	07-12	SOPORTE PARA MOTOR IZQUIERDO Y DERECHO		7365-H



CONTINUACIÓN... SONORA



	 28	APLICACIÓN / DESCRIPTION	DAI PARTS #
SOPORTES / TRANSMISSION & MOTOR MOUNTS			
V8 6.2	07-12	SOPORTE PARA MOTOR IZQUIERDO Y DERECHO	7365-H
V8 6.5	92-99	SOPORTE PARA MOTOR IZQUIERDO Y DERECHO	1920
	94-99	SOPORTE PARA TRANSMISIÓN (4X4)	6874
	94-00	SOPORTE PARA MOTOR IZQUIERDO Y DERECHO	6931

SPARK

SOPORTES / TRANSMISSION & MOTOR MOUNTS			
L4 1.2	11-16	SOPORTE PARA MOTOR DERECHO	7524
		SOPORTE PARA TRANSMISIÓN	7540
		SOPORTE PARA MOTOR TRASERO	7583
		REPUESTO PARA SOPORTE DE MOTOR TRASERO (7583)	7583-9



CONTINUACIÓN... SPARK

	 28	APLICACIÓN / DESCRIPTION	DAI PARTS #
CUBRE POLVOS / C.V. BOOTS			
	11-16	CUBRE POLVO IZQUIERDO Y DERECHO LADO RUEDA	63134
		CUBRE POLVO IZQUIERDO Y DERECHO LADO CAJA (CON TRIPOIDE)	63135
		CUBRE POLVO IZQUIERDO Y DERECHO DE DIRECCIÓN	63136



MISCELÁNEOS / AUTOMOTIVE RUBBER PARTS

11-16	BUJES PARA HORQUILLA (POLIURETANO KIT)	9808
-------	--	------



SS-400

MISCELÁNEOS / AUTOMOTIVE RUBBER PARTS

88-99	BUJES PARA HORQUILLA SUPERIOR	DAI-K-6323
-------	-------------------------------	------------



SUBURBAN

	28	APLICACIÓN / DESCRIPTION	DAI PARTS #
--	----	--------------------------	-------------

SOPORTES / TRANSMISSION & MOTOR MOUNTS

V8 4.3	07-10	SOPORTE PARA MOTOR IZQUIERDO Y DERECHO	7392
	07-11	SOPORTE PARA TRANSMISIÓN	1911
		SOPORTE PARA TRANSMISIÓN	1940

V8 4.8	07-11	SOPORTE PARA TRANSMISIÓN	1911
		SOPORTE PARA TRANSMISIÓN	1940
		SOPORTE PARA TRANSMISIÓN (4X4)	6874
		SOPORTE PARA TRANSMISIÓN (4X4)	6876
	07-12	SOPORTE PARA MOTOR IZQUIERDO Y DERECHO	7365-H

V8 5.0	68-72	SOPORTE PARA MOTOR IZQUIERDO Y DERECHO	1736
	73-81	SOPORTE PARA TRANSMISIÓN STD. Y AUT., 3 VEL.	1704
	73-91	SOPORTE PARA MOTOR IZQUIERDO Y DERECHO	1782
	81-82	SOPORTE PARA TRANSMISIÓN STD. Y AUT., 4 VEL.	6766
		SOPORTE PARA TRANSMISIÓN STD. Y AUT., 4 VEL.	6874
	85-99	SOPORTE PARA TRANSMISIÓN (4X4)	
	82-87	SOPORTE PARA TRANSMISIÓN	1932
	92-99	SOPORTE PARA TRANSMISIÓN	1911
		SOPORTE PARA MOTOR IZQUIERDO Y DERECHO	1920
		SOPORTE PARA TRANSMISIÓN	1940

SOPORTES TRANSMISSION & MOTOR MOUNTS



1704



1736



1782



1911



1920



1932



1940



6766



6874



6876





7365-H



7392



CONTINUACIÓN... SUBURBAN

			APLICACIÓN / DESCRIPTION	DAI PARTS #
SOPORTES / TRANSMISSION & MOTOR MOUNTS				
V8 5.0	92-99		SOPORTE PARA MOTOR IZQUIERDO Y DERECHO	6931
V8 5.3	00-07		SOPORTE PARA MOTOR IZQUIERDO Y DERECHO	7120
	00-11		SOPORTE PARA TRANSMISIÓN	1911
			SOPORTE PARA TRANSMISIÓN	1940
			SOPORTE PARA TRANSMISIÓN (4X4)	6874
	07-12		SOPORTE PARA MOTOR IZQUIERDO Y DERECHO	7365-H
	15-18		SOPORTE PARA MOTOR DERECHO	7638-H
V8 5.7	92-99		SOPORTE PARA TRANSMISIÓN	1911
			SOPORTE PARA MOTOR IZQUIERDO Y DERECHO	1920
			SOPORTE PARA TRANSMISIÓN	1940
			SOPORTE PARA TRANSMISIÓN (4X4)	6874
			SOPORTE PARA MOTOR IZQUIERDO Y DERECHO	6931
V8 6.0	00-11		SOPORTE PARA TRANSMISIÓN	1911
			SOPORTE PARA TRANSMISIÓN	1940
			SOPORTE PARA TRANSMISIÓN (4X4)	6874
	00-07		SOPORTE PARA MOTOR IZQUIERDO Y DERECHO	7120
	07-12		SOPORTE PARA MOTOR IZQUIERDO Y DERECHO	7365-H
V8 6.2	07-12		SOPORTE PARA MOTOR IZQUIERDO Y DERECHO	7365-H
	01-10		SOPORTE PARA BARRA DE TORSION	7548

**SOPORTES
TRANSMISSION & MOTOR MOUNTS**



1911



1920



1940



6874



6931



7120



7365-H



7548



7638-H

NUEVO



CONTINUACIÓN... SUBURBAN

28	APLICACIÓN / DESCRIPTION	DAI PARTS #	DAI KIT PARTS #
BASES PARA AMORTIGUADOR / STRUT MOUNTS			
07-12	BASE PARA AMORTIGUADOR FRONTAL IZQUIERDA Y DERECHA <i>1500</i>		7356-KIT

**BASES PARA AMORTIGUADOR
STRUT MOUNTS**

7356-KIT

28	APLICACIÓN / DESCRIPTION	DAI PARTS #
MISCELÁNEOS / AUTOMOTIVE RUBBER PARTS		
88-99	GOMA PARA BARRA ESTABILIZADORA (4X4) <i>1500 Y 2500</i>	6065
92-99	TORNILLO ESTABILIZADOR (7", 203.2 mm) <i>1500</i>	6102
	TORNILLO ESTABILIZADOR (7", 203.2 mm EQUIPO ORIGINAL) <i>1500</i>	6106
	BUJES PARA HORQUILLA SUPERIOR <i>1500</i>	DAI-K-6323
88-00	BUJES PARA HORQUILLA SUPERIOR <i>2500</i>	
88-94	BUJES PARA HORQUILLA SUPERIOR (4X4) <i>K1500 Y K2500</i>	
88-94	BUJES PARA HORQUILLA SUPERIOR <i>K3500</i>	DAI-K-6395
88-00	BUJE PARA HORQUILLA SUPERIOR <i>2500</i>	
00-06	BUJE PARA HORQUILLA SUPERIOR (4X4) <i>1500</i>	
92-14	BUJE PARA HORQUILLA SUPERIOR <i>1500</i>	
88-99	BUJE PARA HORQUILLA SUPERIOR (4X4) <i>K1500 Y K2500</i>	
88-94	BUJE PARA HORQUILLA SUPERIOR <i>K3500</i>	

**MISCELÁNEOS
AUTOMOTIVE RUBBER PARTS**

6065

6102

6106

DAI-K-6323

DAI-K-6395

TAHOE

 		APLICACIÓN / DESCRIPTION	DAI PARTS #
SOPORTES / TRANSMISSION & MOTOR MOUNTS			
V6 4.3 V8 4.8	07-10	SOPORTE PARA MOTOR IZQUIERDO Y DERECHO	7392
V8 4.8	07-09	SOPORTE PARA MOTOR IZQUIERDO Y DERECHO	7697
V8 4.8 V8 5.3	00-07	SOPORTE PARA MOTOR IZQUIERDO Y DERECHO	7120
	00-11	SOPORTE PARA TRANSMISIÓN	1911
		SOPORTE PARA TRANSMISIÓN	1940
		SOPORTE PARA TRANSMISIÓN (4X4)	6874
07-12	SOPORTE PARA MOTOR IZQUIERDO Y DERECHO	7365-H	
V8 5.3	15-18	SOPORTE PARA MOTOR DERECHO	7638-H
V8 5.7	92-99	SOPORTE PARA MOTOR IZQUIERDO Y DERECHO	1920
	92-00	SOPORTE PARA TRANSMISIÓN (4X4)	6874
		SOPORTE PARA MOTOR IZQUIERDO Y DERECHO	6931
		00-07	SOPORTE PARA MOTOR IZQUIERDO Y DERECHO
V8 6.0	01-11	SOPORTE PARA TRANSMISIÓN	1911
		SOPORTE PARA TRANSMISIÓN	1940
		SOPORTE PARA TRANSMISIÓN (4X4)	6874
	01-07	SOPORTE PARA MOTOR IZQUIERDO Y DERECHO	7120
	07-12	SOPORTE PARA MOTOR IZQUIERDO Y DERECHO	7365-H

**SOPORTES
TRANSMISSION & MOTOR MOUNTS**



1911



1920



1940



6931



6874



7120



7365-H



7392



7638-H



7697



CONTINUACIÓN... TAHOE

 		APLICACIÓN / DESCRIPTION	DAI PARTS #
SOPORTES / TRANSMISSION & MOTOR MOUNTS			
V8 6.2	07-12	SOPORTE PARA MOTOR IZQUIERDO Y DERECHO	7365-H
V8 6.5	92-99	SOPORTE PARA MOTOR IZQUIERDO Y DERECHO	1920
	94-99	SOPORTE PARA TRANSMISIÓN (4X4)	6874
	94-00	SOPORTE PARA MOTOR IZQUIERDO Y DERECHO	6931
	01-10	SOPORTE PARA BARRA DE TORSIÓN	7548





		APLICACIÓN / DESCRIPTION	DAI PARTS #	DAI KIT PARTS #
BASES PARA AMORTIGUADOR / STRUT MOUNTS				
07-12		BASE PARA AMORTIGUADOR FRONTAL IZQUIERDA Y DERECHA		7356-KIT



 		APLICACIÓN / DESCRIPTION	DAI PARTS #
MISCELÁNEOS / AUTOMOTIVE RUBBER PARTS			
	95-99	GOMA PARA BARRA ESTABILIZADORA (4X4)	6065



CONTINUACIÓN... TAHOE

	 28	APLICACIÓN / DESCRIPTION	DAI PARTS #
MISCELÁNEOS / AUTOMOTIVE RUBBER PARTS			
	00-14	BUJE PARA HORQUILLA SUPERIOR	DAI-K-6395
	95-06	BUJE PARA HORQUILLA SUPERIOR (4X4)	

**MISCELÁNEOS
AUTOMOTIVE RUBBER PARTS**



DAI-K-6395

TERRAIN

SOPORTES / TRANSMISSION & MOTOR MOUNTS			
L4 2.4	10-16	SOPORTE PARA MOTOR FRONTAL	7692
V6 3.0	10-12	SOPORTE PARA MOTOR FRONTAL	7691
V6 3.6	13-16		
V6 3.6	10-16	SOPORTE PARA MOTOR DERECHO	7541-H

**SOPORTES
TRANSMISSION & MOTOR MOUNTS**



7541-H



7691

NUEVO



7692

TIGRA

MISCELÁNEOS / AUTOMOTIVE RUBBER PARTS			
	1999	TOPE PARA AMORTIGUADOR FRONTAL IZQUIERDO Y DERECHO	D-037
		TOPE PARA AMORTIGUADOR TRASERO IZQUIERDO Y DERECHO	D-038

**MISCELÁNEOS
AUTOMOTIVE RUBBER PARTS**



D-037



D-038



TODOS LOS MODELOS

		APLICACIÓN / DESCRIPTION	DAI PARTS #
SOPORTES / TRANSMISSION & MOTOR MOUNTS			
L6 3.8 L6 3.9 L6 5.7	53-72	SOPORTE PARA MOTOR FRONTAL IZQUIERDO Y DERECHO	1467
L6 3.5 L6 3.8 L6 5.7	53-72	SOPORTE PARA TRANSMISIÓN	1577

**SOPORTES
TRANSMISSION & MOTOR MOUNTS**

1467

1577
TORNADO

SOPORTES / TRANSMISSION & MOTOR MOUNTS			
L4 1.8	11-15	SOPORTE PARA MOTOR IZQUIERDO	1934
		SOPORTE PARA MOTOR TRASERO	1935
		SOPORTE PARA MOTOR DERECHO FRONTAL	6905
	04-10	SOPORTE PARA MOTOR TRASERO EASY TRONIC Y STD. (COMPLEMENTO 7075)	7074
		SOPORTE PARA MOTOR TRASERO EASY TRONIC Y STD. (COMPLEMENTO 7074)	7075
		SOPORTE PARA TRANSMISIÓN EASY TRONIC Y STD.	7076-H
	SOPORTE PARA MOTOR DERECHO EASY TRONIC Y STD.	7077	
	SOPORTE PARA MOTOR FRONTAL EASY TRONIC Y STD.	7086	

**SOPORTES
TRANSMISSION & MOTOR MOUNTS**

1934

1935

6905

7074

7075

7076-H

7077

7086

CONTINUACIÓN... TORNADO

28	APLICACIÓN / DESCRIPTION	DAI PARTS #	DAI KIT PARTS #
BASES PARA AMORTIGUADOR / STRUT MOUNTS			
04-10	BASE PARA AMORTIGUADOR FRONTAL IZQUIERDA Y DERECHA	1997	

**BASES PARA AMORTIGUADOR
STRUT MOUNTS**



1997

28	APLICACIÓN / DESCRIPTION	DAI PARTS #
CUBRE POLVOS / C.V. BOOTS		
04-10	CUBRE POLVO IZQUIERDO Y DERECHO LADO RUEDA	6380
	CUBRE POLVO IZQUIERDO Y DERECHO LADO RUEDA	63107
	CUBRE POLVO IZQUIERDO Y DERECHO LADO CAJA	63108
	CUBRE POLVO IZQUIERDO Y DERECHO DE DIRECCIÓN	63109
	CUBRE POLVO IZQUIERDO Y DERECHO LADO CAJA	63115
11-16	CUBRE POLVO IZQUIERDO Y DERECHO LADO RUEDA	63100
	CUBRE POLVO IZQUIERDO Y DERECHO LADO CAJA (CON TRIPOIDE)	63101

**CUBRE POLVO
C.V. BOOTS**



6380



63100



63101



63107



63108



63109



63115

MISCELÁNEOS / AUTOMOTIVE RUBBER PARTS		
04-10	TOPE PARA AMORTIGUADOR FRONTAL IZQUIERDO Y DERECHO	D-037
	TOPE PARA AMORTIGUADOR TRASERO IZQUIERDO Y DERECHO	D-038

**MISCELÁNEOS
AUTOMOTIVE RUBBER PARTS**



D-037



D-038



CONTINUACIÓN... TORNADO

28		APLICACIÓN / DESCRIPTION	DAI PARTS #
MISCELÁNEOS / AUTOMOTIVE RUBBER PARTS			
04-10		GOMA PARA BARRA ESTABILIZADORA 3/4"	64706
		BUJE PARA HORQUILLA INFERIOR CHICO	DAI-1403007
		BUJE PARA HORQUILLA INFERIOR CHICO	DAI-1403007 R
04-11		TORNILLO ESTABILIZADOR FRONTAL	DAI-2103001
11-15		BUJE PARA HORQUILLA INFERIOR	DAI-90445097

DAI-1403007 R

DAI-2103001

DAI-90445097
TRACKER

SOPORTES / TRANSMISSION & MOTOR MOUNTS			
L4 1.6	89-98	SOPORTE PARA MOTOR IZQUIERDO Y DERECHO	7432
	98-03	SOPORTE PARA TRANSMISIÓN STD.	7262
	98-00	SOPORTE PARA MOTOR FRONTAL	7261
	99-00	SOPORTE PARA MOTOR IZQUIERDO Y DERECHO	7306
	99-04	SOPORTE PARA TRANSMISIÓN	7269
L4 2.0	99-03	SOPORTE PARA MOTOR IZQUIERDO Y DERECHO	7306

7269

7306

7432



CONTINUACIÓN... TRACKER

 		APLICACIÓN / DESCRIPTION	DAI PARTS #
SOPORTES / TRANSMISSION & MOTOR MOUNTS			
L4 2.0	99-04	SOPORTE PARA TRANSMISIÓN STD.	7262
		SOPORTE PARA TRANSMISIÓN	7269
L4 2.5	01-04	SOPORTE PARA TRANSMISIÓN STD.	7262



	APLICACIÓN / DESCRIPTION	DAI PARTS #	DAI KIT PARTS #
BASES PARA AMORTIGUADOR / STRUT MOUNTS			
89-98	BASE PARA AMORTIGUADOR FRONTAL IZQUIERDA Y DERECHA		7295-KIT
99-04	BASE PARA AMORTIGUADOR FRONTAL IZQUIERDA Y DERECHA		7289-KIT
99-08	BASE PARA AMORTIGUADOR FRONTAL IZQUIERDA Y DERECHA		7290-KIT



 		APLICACIÓN / DESCRIPTION	DAI PARTS #
SOPORTES / TRANSMISSION & MOTOR MOUNTS			
	99-08	BUJE PARA HORQUILLA INFERIOR GRANDE	DAI-1403011
		BUJE PARA HORQUILLA INFERIOR CHICO	DAI-1403012



TRAIL BLAZER

		APLICACIÓN / DESCRIPTION	DAI PARTS #
SOPORTES / TRANSMISSION & MOTOR MOUNTS			
L6 4.2	02-09	SOPORTE PARA MOTOR IZQUIERDO Y DERECHO	7244-H
		SOPORTE PARA TRANSMISIÓN	7311



		APLICACIÓN / DESCRIPTION	DAI PARTS #	DAI KIT PARTS #
BASES PARA AMORTIGUADOR / STRUT MOUNTS				
02-09		BASE PARA AMORTIGUADOR FRONTAL IZQUIERDA Y DERECHA		7377-KIT



		APLICACIÓN / DESCRIPTION	DAI PARTS #
SOPORTES / TRANSMISSION & MOTOR MOUNTS			
	02-08	GOMA PARA BARRA ESTABILIZADORA	64712
		BUJE PARA HORQUILLA SUPERIOR (4X2 Y 4X4)	DAI-1403010
		BUJE PARA HORQUILLA INFERIOR CHICO (4X2 Y 4X4)	DAI-1403013
		BUJE PARA HORQUILLA INFERIOR GRANDE (4X2 Y 4X4)	DAI-1403014



TRAX

 		APLICACIÓN / DESCRIPTION	DAI PARTS #
SOPORTES / TRANSMISSION & MOTOR MOUNTS			
L4 1.4	14-16	SOPORTE PARA TRANSMISIÓN TURBO	7496-H
		SOPORTE PARA MOTOR TRASERO	7499
		COMPLEMENTO PARA SOPORTE DE MOTOR TRASERO AUT. (7499)	7555
L4 1.8	14-16	SOPORTE PARA MOTOR TRASERO	7499
		COMPLEMENTO PARA SOPORTE DE MOTOR TRASERO AUT. (7499)	7555



		APLICACIÓN / DESCRIPTION	DAI PARTS #	DAI KIT PARTS #
BASES PARA AMORTIGUADOR / STRUT MOUNTS				
14-16	BASE PARA AMORTIGUADOR FRONTAL IZQUIERDA Y DERECHA		7385	
	BASE PARA AMORTIGUADOR TRASERA IZQUIERDA Y DERECHA		7386	



TRAVERSE

 		APLICACIÓN / DESCRIPTION	DAI PARTS #
SOPORTES / TRANSMISSION & MOTOR MOUNTS			
V6 3.6	07-16	SOPORTE PARA MOTOR TRASERO TORQUE STRUT	7587
		SOPORTE PARA MOTOR TRASERO DERECHO	7559-H



CONTINUACIÓN... TRAVERSE

 		APLICACIÓN / DESCRIPTION	DAI PARTS #
SOPORTES / TRANSMISSION & MOTOR MOUNTS			
V6 3.6	07-16	SOPORTE PARA MOTOR FRONTAL DERECHO	7735

**SOPORTES
TRANSMISSION & MOTOR MOUNTS**

7735
UPLANDER

SOPORTES / TRANSMISSION & MOTOR MOUNTS			
V6 3.5	05-09	SOPORTE PARA MOTOR FRONTAL SUPERIOR IZQUIERDO Y DERECHO	7123
V6 3.5 V6 3.9	05-09	SOPORTE PARA TRANSMISIÓN	6844
		SOPORTE PARA MOTOR DERECHO	6838-H
		SOPORTE PARA MOTOR DERECHO	6875-H
		REPUESTO DE SOPORTE TORSIÓN FRONTAL SUPERIOR IZQUIERDO Y DERECHO (7172)	7172-9
		SOPORTE PARA MOTOR DERECHO	7448-H

**SOPORTES
TRANSMISSION & MOTOR MOUNTS**

6838-H

6844

6875-H

7172-9

7123



7448-H

		APLICACIÓN / DESCRIPTION	DAI PARTS #	DAI KIT PARTS #
BASES PARA AMORTIGUADOR / STRUT MOUNTS				
05-09		BASE PARA AMORTIGUADOR FRONTAL IZQUIERDA Y DERECHA		7222-KIT

**BASES PARA AMORTIGUADOR
STRUT MOUNTS**

7222-KIT

CONTINUACIÓN... UPLANDER

 		APLICACIÓN / DESCRIPTION	DAI PARTS #
MISCELÁNEOS / AUTOMOTIVE RUBBER PARTS			
05-09		BUJE PARA HORQUILLA GRANDE	DAI-1403005
		BUJE PARA HORQUILLA CHICO	DAI-1403006
		TORNILLO ESTABILIZADOR	DAI-15851956



VARIOS

MISCELÁNEOS / AUTOMOTIVE RUBBER PARTS			
		GOMA PARA AMORTIGUADOR CÓNICA	36
		GOMA PARA AMORTIGUADOR CÓNICA	34
		TOPE PARA SUSPENSIÓN (DIAM. 40 mm ALT. 50 mm)	302
		AUMENTO PARA RESORTE	407
		GOMA PARA RADIADOR SUPERIOR	500
		GOMA PARA RADIADOR INFERIOR	501
66-79		COPLER PARA DIRECCIÓN STD. (SINFIN REDONDO DE .725" 2 PERNOS DELGADOS)	602
72-08		COPLER PARA DIRECCIÓN HID. Y ALGUNOS DIRECCIÓN STD. (SINFIN REBAJADO DE .725" PERNOS DELGADOS)	605



IMPORTANTE: Identifica nuestro producto con el grabado del logo  No aceptes imitaciones.



CONTINUACIÓN... VARIOS

		APLICACIÓN / DESCRIPTION	DAI PARTS #
MISCELÁNEOS / AUTOMOTIVE RUBBER PARTS			
65-08		GALLETAS PARA DIRECCIÓN STD. (2 PERNOS DELGADOS COMPLETO 602, 610, 608 Y 614)	622
		TAPÓN PARA BOMBA DE AGUA 3/4"	6012
		TOPE PARA SUSPENSIÓN TRASERA (ANCHO 47 mm)	6124

VECTRA

SOPORTES / TRANSMISSION & MOTOR MOUNTS			
L4 2.2 L4 2.8 L4 3.2	02-08	SOPORTE PARA MOTOR FRONTAL AUT.	7305
		SOPORTE PARA MOTOR TRASERO	7313
		SOPORTE PARA MOTOR DERECHO	7334-H
		SOPORTE PARA TRANSMISIÓN	7335-H
		SOPORTE PARA MOTOR FRONTAL STD.	7478
		REPUESTO PARA SOPORTE DE MOTOR FRONTAL Y TRASERO (7305, 7313 y 7478)	7478-9



NUEVO



CONTINUACIÓN... VECTRA

28		APLICACIÓN / DESCRIPTION	DAI PARTS #	DAI KIT PARTS #
BASES PARA AMORTIGUADOR / STRUT MOUNTS				
02-08		BASE PARA AMORTIGUADOR FRONTAL IZQUIERDA Y DERECHA	7317	



28		APLICACIÓN / DESCRIPTION	DAI PARTS #
CUBRE POLVOS / C.V. BOOTS			
L4 2.2	02-08	CUBRE POLVO IZQUIERDO Y DERECHO LADO RUEDA	6316



MISCELÁNEOS / AUTOMOTIVE RUBBER PARTS			
	02-08	TOPE PARA AMORTIGUADOR FRONTAL IZQUIERDO Y DERECHO	D-022
		TOPE PARA AMORTIGUADOR FRONTAL IZQUIERDO Y DERECHO	D-037
		BUJE PARA HORQUILLA INFERIOR CHICO	DAI-352364
		TORNILLO ESTABILIZADOR FRONTRAL	DAI-2103009

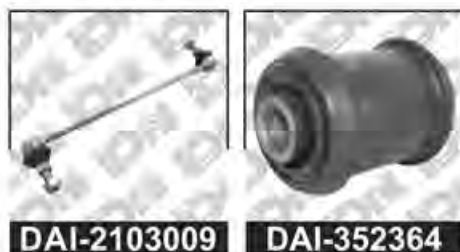



VENTURE

 		APLICACIÓN / DESCRIPTION	DAI PARTS #
SOPORTES / TRANSMISSION & MOTOR MOUNTS			
V6 3.4	97-04	SOPORTE PARA TRANSMISIÓN	6844
		SOPORTE PARA MOTOR DERECHO	6838-H
		SOPORTE PARA MOTOR DERECHO	6875-H
		REPUESTO PARA SOPORTE DE TORSIÓN FRONTAL SUPERIOR IZQUIERDO Y DERECHO (7172)	7172-9
		SOPORTE PARA MOTOR FRONTAL SUPERIOR IZQUIERDO Y DERECHO	7166
		SOPORTE PARA MOTOR DERECHO	7448-H



	APLICACIÓN / DESCRIPTION	DAI PARTS #	DAI KIT PARTS #
BASES PARA AMORTIGUADOR / STRUT MOUNTS			
97-04	BASE PARA AMORTIGUADOR FRONTAL IZQUIERDA Y DERECHA		7222-KIT



 		APLICACIÓN / DESCRIPTION	DAI PARTS #
CUBRE POLVOS / C.V. BOOTS			
	97-04	CUBRE POLVO IZQUIERDO Y DERECHO LADO RUEDA	6337
		CUBRE POLVO IZQUIERDO Y DERECHO LADO RUEDA	6318



CONTINUACIÓN... VENTURE

 		APLICACIÓN / DESCRIPTION	DAI PARTS #
MISCELÁNEOS / AUTOMOTIVE RUBBER PARTS			
97-04		GOMA PARA BARRA ESTABILIZADORA	64721
		TOPE PARA AMORTIGUADOR FRONTAL IZQUIERDO Y DERECHO	D-0622
		BUJE PARA HORQUILLA GRANDE	DAI-1403005
		BUJE PARA HORQUILLA CHICO	DAI-1403006



YUKON

SOPORTES / TRANSMISSION & MOTOR MOUNTS			
V6 4.3	07-10	SOPORTE PARA MOTOR IZQUIERDO Y DERECHO	7392
V8 4.3	07-11	SOPORTE PARA TRANSMISIÓN	1940
		SOPORTE PARA TRANSMISIÓN	1911
V8 4.8 V8 5.3	00-07	SOPORTE PARA MOTOR IZQUIERDO Y DERECHO	7120
	00-11	SOPORTE PARA TRANSMISIÓN	1911
		SOPORTE PARA TRANSMISIÓN (4X4)	6874
V8 8.1	01-06	SOPORTE PARA MOTOR IZQUIERDO Y DERECHO	7128



CONTINUACIÓN... YUKON

 		APLICACIÓN / DESCRIPTION	DAI PARTS #
SOPORTES / TRANSMISSION & MOTOR MOUNTS			
V8 4.8	07-12	SOPORTE PARA MOTOR IZQUIERDO Y DERECHO	7365-H
V8 5.3			
V8 6.0			
V8 6.2			
V8 4.8	07-09	SOPORTE PARA MOTOR IZQUIERDO Y DERECHO	7697
V8 5.3	14-18	SOPORTE PARA MOTOR DERECHO	7638-H
V8 6.2			
V8 5.7	92-99	SOPORTE PARA MOTOR IZQUIERDO Y DERECHO	1920
	92-00	SOPORTE PARA TRANSMISIÓN (4X4)	6874
		SOPORTE PARA MOTOR IZQUIERDO Y DERECHO	6931
	2000	SOPORTE PARA MOTOR IZQUIERDO Y DERECHO	7120
V8 6.0	01-11	SOPORTE PARA TRANSMISIÓN	1911
		SOPORTE PARA TRANSMISIÓN	1940
		SOPORTE PARA TRANSMISIÓN (4X4)	6874
	01-07	SOPORTE PARA MOTOR IZQUIERDO Y DERECHO	7120
V8 6.5	92-99	SOPORTE PARA MOTOR IZQUIERDO Y DERECHO	1920
	94-99	SOPORTE PARA TRANSMISIÓN (4X4)	6874
	94-00	SOPORTE PARA MOTOR IZQUIERDO Y DERECHO	6931
	01-10	SOPORTE PARA BARRA DE TORSIÓN	7548

**SOPORTES
TRANSMISSION & MOTOR MOUNTS**

1911

1920

1940

6874

6931

7120

7365-H

7548

7638-H

7697
NUEVO
NUEVO

CONTINUACIÓN... YUKON

 28	APLICACIÓN / DESCRIPTION	DAI PARTS #	DAI KIT PARTS #
BASES PARA AMORTIGUADOR / STRUT MOUNTS			
07-12	BASE PARA AMORTIGUADOR FRONTAL IZQUIERDA Y DERECHA 1500		7356-KIT

**BASES PARA AMORTIGUADOR
STRUT MOUNTS**



7356-KIT

 28	APLICACIÓN / DESCRIPTION	DAI PARTS #
MISCELÁNEOS / AUTOMOTIVE RUBBER PARTS		
00-06	BUJE PARA HORQUILLA SUPERIOR (4X4) 1500	DAI-K-6395
00-14	BUJE PARA HORQUILLA SUPERIOR 1500	

**MISCELÁNEOS
AUTOMOTIVE RUBBER PARTS**



DAI-K-6395

ZAFIRA

SOPORTES / TRANSMISSION & MOTOR MOUNTS			
L4 1.8 L4 2.2	00-08	SOPORTE PARA MOTOR FRONTAL AUT.	7011
		REPUESTO PARA SOPORTE PARA MOTOR FRONTAL TRANSMISIÓN AUT. (7011 Y 7022)	7011-9
		SOPORTE PARA TRANSMISIÓN STD. Y AUT.	7014
		SOPORTE PARA MOTOR TRASERO IZQUIERDO	7020

**SOPORTES
TRANSMISSION & MOTOR MOUNTS**



7011

7011-9



7014



7020



CONTINUACIÓN... ZAFIRA

		APLICACIÓN / DESCRIPTION	DAI PARTS #
SOPORTES / TRANSMISSION & MOTOR MOUNTS			
L4 1.8 L4 2.2	00-08	SOPORTE PARA MOTOR FRONTAL STD.	7021
		SOPORTE PARA MOTOR FRONTAL AUT.	7022
		SOPORTE PARA MOTOR DERECHO	7023
		REPUESTO PARA SOPORTE PARA MOTOR DERECHO (7023)	7023-9
		SOPORTE PARA MOTOR FRONTAL STD.	7078

L4 2.0 L4 2.4	04-08	SOPORTE PARA TRANSMISIÓN STD. Y AUT.	7014
		REPUESTO PARA SOPORTE PARA MOTOR FRONTAL TRANSMISIÓN AUT., (7011 Y 7022)	7011-9
		SOPORTE PARA MOTOR TRASERO IZQUIERDO	7020
		SOPORTE PARA MOTOR FRONTAL STD.	7021
		SOPORTE PARA MOTOR FRONTAL AUT.	7022
		SOPORTE PARA MOTOR DERECHO	7023
		REPUESTO PARA SOPORTE PARA MOTOR DERECHO (7023)	7023-9
		SOPORTE PARA MOTOR FRONTAL STD.	7078

**SOPORTES
TRANSMISSION & MOTOR MOUNTS**

7011-9

7014

7020

7021

7022

7023

7023-9

7078

		APLICACIÓN / DESCRIPTION	DAI PARTS #	DAI KIT PARTS #
BASES PARA AMORTIGUADOR / STRUT MOUNTS				
02-06		BASE PARA AMORTIGUADOR FRONTAL IZQUIERDA Y DERECHA	1997	

**BASES PARA AMORTIGUADOR
STRUT MOUNTS**

1997

CONTINUACIÓN... ZAFIRA

 		APLICACIÓN / DESCRIPTION	DAI PARTS #
CUBRE POLVOS / C.V. BOOTS			
L4 1.8	02-08	CUBRE POLVO IZQUIERDO Y DERECHO LADO RUEDA	6380
		CUBRE POLVO IZQUIERDO Y DERECHO LADO RUEDA	63107
		CUBRE POLVO IZQUIERDO Y DERECHO LADO CAJA	63108
		CUBRE POLVO IZQUIERDO Y DERECHO CAJA DE DIRECCIÓN	63109
		CUBRE POLVO IZQUIERDO Y DERECHO LADO CAJA	63115



MISCELÁNEOS / AUTOMOTIVE RUBBER PARTS			
	02-06	GOMA PARA BARRA ESTABILIZADORA	64718
	02-08	TOPE PARA AMORTIGUADOR FRONTAL IZQUIERDO Y DERECHO	D-037
		BUJE PARA HORQUILLA INFERIOR CHICO	DAI-352364
	02-08	TOPE PARA AMORTIGUADOR FRONTAL IZQUIERDO Y DERECHO	DAI-352365
		00-06	TORNILLO ESTABILIZADOR FRONTAL







A large sheet of white paper with horizontal ruling lines, pinned to the page. The paper has a slightly distressed, torn-edge appearance at the bottom.



DODGE / CHRYSLER

200

 		APLICACIÓN / DESCRIPTION	DAI PARTS #
SOPORTES / TRANSMISSION & MOTOR MOUNTS			
L4 2.4	11-14	SOPORTE PARA MOTOR FRONTAL	7279
		REPUESTO PARA SOPORTE DE MOTOR FRONTAL Y TRASERO (BUJE INTERNO GRANDE OVALADO) (7279 Y 7310)	7279-9
		SOPORTE PARA MOTOR TRASERO	7310
		REPUESTO PARA SOPORTE DE TRANSMISIÓN (7337)	7337-9
V6 3.6	11-14	SOPORTE PARA MOTOR TRASERO	7310
		REPUESTO PARA SOPORTE DE MOTOR FRONTAL Y TRASERO (BUJE INTERNO GRANDE OVALADO) (7279 Y 7310)	7279-9



		APLICACIÓN / DESCRIPTION	DAI PARTS #	DAI KIT PARTS #
BASES PARA AMORTIGUADOR / STRUT MOUNTS				
11-14		BASE PARA AMORTIGUADOR FRONTAL IZQUIERDA Y DERECHA		7596-KIT



 		APLICACIÓN / DESCRIPTION	DAI PARTS #
MISCELÁNEOS / AUTOMOTIVE RUBBER PARTS			
	11-12	KIT DE BUJES PARA SUSPENSIÓN TRASERA EN POLIURETANO 4 BUJES CHICOS, D. INT. 0.480" D. EXT. 1.575", ALTURA 1.650" 2 BUJES GRANDES D. INT. 0.480" D. EXT. 1.655", ALTURA 1.650"	9802



CONTINUACIÓN... 200

  28		APLICACIÓN / DESCRIPTION	DAI PARTS #
MISCELÁNEOS / AUTOMOTIVE RUBBER PARTS			
11-12		BUJE PARA SUSPENSIÓN TRASERA GRANDE D. INT. 0.480" D. EXT. 1.655" ALTURA 1.650"	9802-1
		BUJE CHICO PARA SUSPENSIÓN TRASERA D. INT. 0.480" D. EXT. 1.575" ALTURA 1.650	9802-2
11-14		BUJE PARA HORQUILLA INFERIOR CHICO	DAI-1406048
		BUJE PARA HORQUILLA INFERIOR GRANDE	DAI-1406055
		TORNILLO ESTABILIZADOR	DAI-2106016

300

SOPORTES / TRANSMISSION & MOTOR MOUNTS			
V6 2.7 V6 3.5	05-10	SOPORTE PARA MOTOR IZQUIERDO Y DERECHO	7442-H
V8 5.7 V8 6.1	05-10	SOPORTE PARA MOTOR IZQUIERDO Y DERECHO	7698-H



CONTINUACIÓN... 300

28		APLICACIÓN / DESCRIPTION	DAI PARTS #	DAI KIT PARTS #
BASES PARA AMORTIGUADOR / STRUT MOUNTS				
05-15		BASE PARA AMORTIGUADOR FRONTAL IZQUIERDA		7593-KIT
		BASE PARA AMORTIGUADOR FRONTAL DERECHA		7594-KIT



28		APLICACIÓN / DESCRIPTION	DAI PARTS #
MISCELÁNEOS / AUTOMOTIVE RUBBER PARTS			
	05-14	BUJE PARA HORQUILLA INFERIOR	DAI-1406091



300-C

SOPORTES / TRANSMISSION & MOTOR MOUNTS			
V8 5.7	05-10	SOPORTE PARA MOTOR IZQUIERDO Y DERECHO	7698-H
V8 6.1			



28		APLICACIÓN / DESCRIPTION	DAI PARTS #	DAI KIT PARTS #
BASES PARA AMORTIGUADOR / STRUT MOUNTS				
05-14		BASE PARA AMORTIGUADOR FRONTAL IZQUIERDA		7593-KIT
		BASE PARA AMORTIGUADOR FRONTAL DERECHA		7594-KIT



CONTINUACIÓN... 300-C

 28	APLICACIÓN / DESCRIPTION	DAI PARTS #
MISCELÁNEOS / AUTOMOTIVE RUBBER PARTS		
05-15	BUJE PARA HORQUILLA INFERIOR	DAI-1406091

**MISCELÁNEOS
AUTOMOTIVE RUBBER PARTS**

DAI-1406091
300-M

SOPORTES / TRANSMISSION & MOTOR MOUNTS			
V6 3.5	99-04	SOPORTE PARA TRANSMISIÓN	6695
		SOPORTE PARA TRANSMISIÓN (TIPO ORIGINAL)	6840
		SOPORTE PARA MOTOR IZQUIERDO Y DERECHO	6848-H

**SOPORTES
TRANSMISSION & MOTOR MOUNTS**

6695

6840

6848-H



 28	APLICACIÓN / DESCRIPTION	DAI PARTS #	DAI KIT PARTS #
BASES PARA AMORTIGUADOR / STRUT MOUNTS			
98-01	BASE PARA AMORTIGUADOR TRASERA IZQUIERDA Y DERECHA		7230-KIT
	BASE PARA AMORTIGUADOR FRONTAL IZQUIERDA Y DERECHA		7341-KIT

**BASES PARA AMORTIGUADOR
STRUT MOUNTS**

7230-KIT

7341-KIT

CONTINUACIÓN... 300-M



 		APLICACIÓN / DESCRIPTION	DAI PARTS #
MISCELÁNEOS / AUTOMOTIVE RUBBER PARTS			
98-01	TOPE PARA AMORTIGUADOR FRONTAL IZQUIERDO Y DERECHO		D-0619
	TORNILLO ESTABILIZADOR FRONTAL		DAI-2106008



600

		APLICACIÓN / DESCRIPTION	DAI PARTS #	DAI KIT PARTS #
BASES PARA AMORTIGUADOR / STRUT MOUNTS				
83-88	BASE PARA AMORTIGUADOR FRONTAL IZQUIERDA Y DERECHA		6641	
	BASE PARA AMORTIGUADOR FRONTAL IZQUIERDA Y DERECHA			6758-KIT
	BALERO PARA BASE DE AMORTIGUADOR 6641 Y 6758-KIT		6141	



 		APLICACIÓN / DESCRIPTION	DAI PARTS #
MISCELÁNEOS / AUTOMOTIVE RUBBER PARTS			
83-88	TOPE PARA AMORTIGUADOR FRONTAL IZQUIERDO Y DERECHO		D-0622



880

 28	APLICACIÓN / DESCRIPTION	DAI PARTS #
MISCELÁNEOS / AUTOMOTIVE RUBBER PARTS		
65-73	TORNILLO EXCENTRICO	64600



ARIES

 28	APLICACIÓN / DESCRIPTION	DAI PARTS #	DAI KIT PARTS #
BASES PARA AMORTIGUADOR / STRUT MOUNTS			
81-83	BASE PARA AMORTIGUADOR FRONTAL IZQUIERDA Y DERECHA	1808	1808-KIT
84-85	BASE PARA AMORTIGUADOR FRONTAL IZQUIERDA Y DERECHA	1820	1820-KIT
84-88	BASE PARA AMORTIGUADOR FRONTAL IZQUIERDA Y DERECHA	6641	
	BASE PARA AMORTIGUADOR FRONTAL IZQUIERDA Y DERECHA		6758-KIT
	BALERO PARA BASES DE AMORTIGUADOR 6641 Y 6758-KIT	6141	
1986	BALERO PARA BASE DE AMORTIGUADOR 6636, 6650 Y 6650-KIT	6140	
86-88	BASE PARA AMORTIGUADOR FRONTAL IZQUIERDA Y DERECHA	6636	



CONTINUACIÓN... ARIES

28		APLICACIÓN / DESCRIPTION	DAI PARTS #	DAI KIT PARTS #
BASES PARA AMORTIGUADOR / STRUT MOUNTS				
86-88		BASE PARA AMORTIGUADOR FRONTAL IZQUIERDA Y DERECHA	6650	6650-KIT



28		APLICACIÓN / DESCRIPTION	DAI PARTS #
MISCELÁNEOS / AUTOMOTIVE RUBBER PARTS			
	81-83	TOPE PARA AMORTIGUADOR FRONTAL IZQUIERDO Y DERECHO	D-0619
	81-88	GOMA PARA TIRANTE DE SUSPENSIÓN	64490
	84-88	TOPE PARA AMORTIGUADOR FRONTAL IZQUIERDO Y DERECHO	D-0622



ASPEN

SOPORTES / TRANSMISSION & MOTOR MOUNTS			
V8 4.7 V8 5.7	07-09	SOPORTE PARA TRANSMISIÓN AUT.	7463



AUTOS

	 28	APLICACIÓN / DESCRIPTION	DAI PARTS #
MISCELÁNEOS / AUTOMOTIVE RUBBER PARTS			
		TOPE PARA HORQUILLA	388
		GOMA PARA ALTERNADOR	506



AVENGER

SOPORTES / TRANSMISSION & MOTOR MOUNTS			
L4 2.0	95-98	SOPORTE PARA MOTOR FRONTAL	7787
	07-11	SOPORTE PARA MOTOR FRONTAL	7279
		SOPORTE PARA MOTOR TRASERO	7310
		SOPORTE PARA MOTOR DERECHO	7329-H
		SOPORTE PARA TRANSMISIÓN	7337
L4 2.4	07-11	SOPORTE PARA MOTOR DERECHO	7329-H
		SOPORTE PARA TRANSMISIÓN	7337
	07-12	SOPORTE PARA MOTOR TRASERO	7310
	07-14	SOPORTE PARA MOTOR FRONTAL	7279
	08-11	REPUESTO PARA SOPORTE DE TRANSMISIÓN (7337)	7337-9
	95-99	SOPORTE PARA MOTOR FRONTAL	7784



CONTINUACIÓN... AVENGER

 		APLICACIÓN / DESCRIPTION	DAI PARTS #
SOPORTES / TRANSMISSION & MOTOR MOUNTS			
L4 2.4	07-14	REPUESTO PARA SOPORTE DE MOTOR FRONTAL Y TRASERO (BUJE INTERNO GRANDE OVALADO) (7279 Y 7310)	7279-9
V6 2.7	08-10		
V6 3.5			
V6 3.6			
V6 3.5	08-10	SOPORTE PARA MOTOR FRONTAL	7279
		SOPORTE PARA MOTOR TRASERO	7310
		REPUESTO PARA SOPORTE DE TRANSMISIÓN (7337)	7337-9
V6 3.6	11-14	SOPORTE PARA MOTOR TRASERO	7310

**SOPORTES
TRANSMISSION & MOTOR MOUNTS**



7279



7279-9



7310



7337-9

		APLICACIÓN / DESCRIPTION	DAI PARTS #	DAI KIT PARTS #
BASES PARA AMORTIGUADOR / STRUT MOUNTS				
07-14		BASE PARA AMORTIGUADOR FRONTAL IZQUIERDA Y DERECHA	7332	
08-14		BASE PARA AMORTIGUADOR FRONTAL IZQUIERDA Y DERECHA		7596-KIT

**BASES PARA AMORTIGUADOR
STRUT MOUNTS**



7332



7596-KIT

 		APLICACIÓN / DESCRIPTION	DAI PARTS #
MISCELÁNEOS / AUTOMOTIVE RUBBER PARTS			
	07-11	BUJE PARA SUSPENSIÓN TRASERA GRANDE D. INT. 0.480" D. EXT. 1.655" ALTURA 1.650"	9802-1

**MISCELÁNEOS
AUTOMOTIVE RUBBER PARTS**



9802-1



CONTINUACIÓN... AVENGER

	28	APLICACIÓN / DESCRIPTION	DAI PARTS #
MISCELÁNEOS / AUTOMOTIVE RUBBER PARTS			
07-11		KIT DE BUJES PARA SUSPENSIÓN TRASERA EN POLIURETANO 4 BUJES CHICOS, D. INT. 0.4802" D. EXT. 1.575", ALTURA 1.650" 2 BUJES GRANDES D. INT. 0.480" D. EXT. 1.655", ALTURA 1.650"	9802
		BUJE CHICO PARA SUSPENSIÓN TRASERA D. INT. 0.480" D. EXT. 1.575" ALTURA 1.650"	9802-2
07-13		BUJE PARA EJE TRASERO	64821
		BUJE PARA HORQUILLA INFERIOR GRANDE	DAI-1406055
		BUJE PARA HORQUILLA INFERIOR CHICO	DAI-1406048
07-14		TORNILLO ESTABILIZADOR	DAI-2106016

**MISCELÁNEOS
AUTOMOTIVE RUBBER PARTS**

9802

9802-2

64821

DAI-1406048

DAI-1406055

DAI-2106016
B-150, 250 Y 350 VAM

MISCELÁNEOS / AUTOMOTIVE RUBBER PARTS		
70-78	TORNILLO EXCENTRICO	64600

**MISCELÁNEOS
AUTOMOTIVE RUBBER PARTS**

64600

BARRACUDA

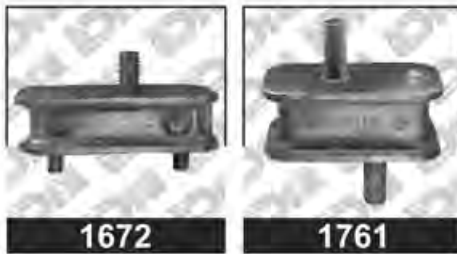

 		APLICACIÓN / DESCRIPTION	DAI PARTS #
SOPORTES / TRANSMISSION & MOTOR MOUNTS			
L6 2.8 L6 3.7	67-73	SOPORTE PARA MOTOR IZQUIERDO	1664
		SOPORTE PARA MOTOR IZQUIERDO	1761
		SOPORTE PARA TRANSMISIÓN STD. Y AUT.	1648
V6 5.2 V6 5.9	68-74	SOPORTE PARA MOTOR DERECHO	1672
		SOPORTE PARA TRANSMISIÓN STD. Y AUT.	1648

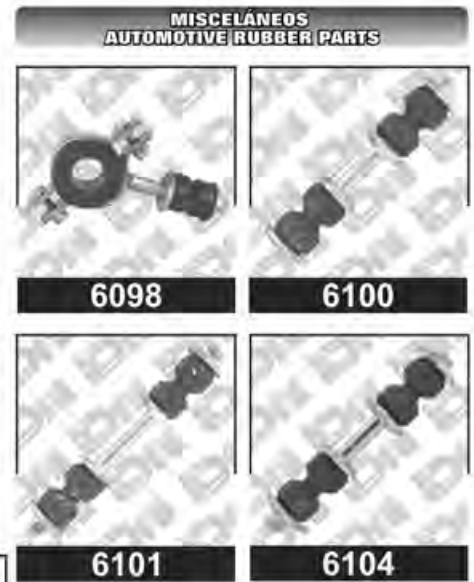

MISCELÁNEOS / AUTOMOTIVE RUBBER PARTS		
62-72	TORNILLO ESTABILIZADOR (6", 177.800 mm)	6101
	TORNILLO ESTABILIZADOR (6", 177.800 mm EQUIPO ORIGINAL)	6105
62-76	GOMA PARA TIRANTE DE SUSPENSIÓN	64570
	TORNILLO EXCENTRICO	64600
77-82	TORNILLO ESTABILIZADOR FRONTAL IZQUIERDO Y DERECHO (CORTO)	6098
	TORNILLO ESTABILIZADOR	64590
73-76	TORNILLO ESTABILIZADOR (5", 1542.4 mm)	6100
	TORNILLO ESTABILIZADOR (5", 1542.4 mm EQUIPO ORIGINAL)	6104



CALIBER

  28		APLICACIÓN / DESCRIPTION	DAI PARTS #
SOPORTES / TRANSMISSION & MOTOR MOUNTS			
L4 1.8	07-09	SOPORTE PARA MOTOR TRASERO	7414
		SOPORTE PARA MOTOR STD.	7749
		SOPORTE PARA MOTOR DERECHO TRASERO	7765
L4 2.0 L4 2.4	07-12	SOPORTE PARA MOTOR FRONTAL	7208
		REPUESTO PARA SOPORTE DE MOTOR FRONTAL (7208)	7208-9
		SOPORTE PARA MOTOR DERECHO	7348
		REPUESTO PARA SOPORTE MOTOR DERECHO (7348)	7348-9
		SOPORTE PARA TRANSMISIÓN	7358
		SOPORTE PARA MOTOR TRASERO	7414
		REPUESTO PARA SOPORTE DE MOTOR TRASERO AUT.	7414-9
		SOPORTE PARA MOTOR TRASERO	7359
		SOPORTE PARA TRANSMISIÓN STD.	7749
		SOPORTE PARA MOTOR DERECHO TRASERO	7765
SOPORTE PARA MOTOR TRASERO	7414		

SOPORTES TRANSMISSION & MOTOR MOUNTS



7208



7208-9



7348



7348-9



7358



7359



7414

7414-9

7749

7765

 28		APLICACIÓN / DESCRIPTION	DAI PARTS #	DAI KIT PARTS #
BASES PARA AMORTIGUADOR / STRUT MOUNTS				
07-12		BASE PARA AMORTIGUADOR FRONTAL IZQUIERDA Y DERECHA	7332	

BASES PARA AMORTIGUADOR STRUT MOUNTS



7332



CONTINUACIÓN... CALIBER

	28	APLICACIÓN / DESCRIPTION	DAI PARTS #
CUBRE POLVOS / C.V. BOOTS			
	08-14	CUBRE POLVO IZQUIERDO Y DERECHO LADO RUEDA	63165
		CUBRE POLVO IZQUIERDO Y DERECHO LADO CAJA AUT. CON TRIPOIDE	63166



MISCELÁNEOS / AUTOMOTIVE RUBBER PARTS

	07-12	KIT DE BUJES PARA SUSPENSIÓN TRASERA EN POLIURETANO 4 BUJES CHICOS, D. INT. 0.480" D. EXT. 1.575", ALTURA 1.650" 2 BUJES GRANDES D. INT. 0.480" D. EXT. 1.655", ALTURA 1.650"	9802
		BUJE CHICO PARA SUSPENSIÓN TRASERA D. INT. 0.480" D. EXT. 1.655" ALTURA 1.650	9802-1
		BUJE CHICO PARA SUSPENSIÓN TRASERA D. INT. 0.480" D. EXT. 1.575" ALTURA 1.650	9802-2
		BUJE PARA EJE TRASERO	64821
		BUJE PARA HORQUILLA INFERIOR CHICO	DAI-1415001
		BUJE PARA HORQUILLA INFERIOR GRANDE	DAI-1415002



CONTINUACIÓN... CALIBER

		APLICACIÓN / DESCRIPTION	DAI PARTS #
MISCELÁNEOS / AUTOMOTIVE RUBBER PARTS			
	07-12	TORNILLO ESTABILIZADOR	DAI-2106016

**MISCELÁNEOS
AUTOMOTIVE RUBBER PARTS**

DAI-2106016
CAMIONETAS

MISCELÁNEOS / AUTOMOTIVE RUBBER PARTS			
		TOPE PARA HORQUILLA	388
	77-84	GOMA PARA BARRA ESTABILIZADORA	6430
	82-84	GOMA PARA BARRA ESTABILIZADORA	6431
	94-99	GOMA PARA BARRA ESTABILIZADORA	6419

**SOPORTES TRANSMISION
& MOTOR MOUNTS**

388

6419

6430

6431
CARAVAN



SOPORTES / TRANSMISION & MOTOR MOUNTS			
V6 3.3	90-95	SOPORTE PARA MOTOR FRONTAL	6651
		REPUESTO PARA SOPORTE DE MOTOR FRONTAL (6651)	1927

**SOPORTES TRANSMISION
& MOTOR MOUNTS**

1927

6651

CONTINUACIÓN... CARAVAN

  28		APLICACIÓN / DESCRIPTION	DAI PARTS #
SOPORTES / TRANSMISSION & MOTOR MOUNTS			
V6 3.3	90-95	SOPORTE PARA MOTOR DERECHO	6652
		REPUESTO PARA SOPORTE MOTOR DERECHO (6652)	1973
		SOPORTE PARA TRANSMISIÓN	6668
		REPUESTO PARA SOPORTE DE TRANSMISIÓN (6668)	1928
		SOPORTE PARA MOTOR DERECHO	6913
		SOPORTE PARA MOTOR DERECHO	6913-H
	08-10	SOPORTE PARA MOTOR FRONTAL	7279
		SOPORTE PARA MOTOR TRASERO	7310
		REPUESTO PARA SOPORTE DE TRANSMISIÓN (7337)	7337-9
		REPUESTO PARA SOPORTE DE MOTOR FRONTAL	7716-9
		REPUESTO PARA SOPORTE DE MOTOR TRASERO	7723-9
		SOPORTE PARA MOTOR DERECHO	7567-H
V6 3.6	11-16	REPUESTO PARA SOPORTE DE TRANSMISIÓN (7337)	7337-9
V6 3.8	96-00	SOPORTE PARA MOTOR FRONTAL	6938
		SOPORTE PARA MOTOR DERECHO	6942

SOPORTES TRANSMISSION & MOTOR MOUNTS



1928 1973



6652 6668



6913 6913-H



6938 6942



7279 7310 7337-9 7567-H



7716-9 7723-9



CONTINUACIÓN... CARAVAN

		28	APLICACIÓN / DESCRIPTION	DAI PARTS #
SOPORTES / TRANSMISSION & MOTOR MOUNTS				
V6 3.8	96-00		SOPORTE PARA TRANSMISIÓN	7012
			REPUESTO PARA SOPORTE DE MOTOR FRONTAL Y TRANSMISIÓN (6938 Y 7012)	7012-9
			SOPORTE PARA TRANSMISIÓN AUT.	7028
			REPUESTO PARA SOPORTE DE MOTOR (7028 Y 7054)	7028-9
			REPUESTO PARA SOPORTE DE MOTOR DERECHO (6942)	6950
	01-08		SOPORTE PARA MOTOR FRONTAL	7119
			REPUESTO PARA SOPORTE DE MOTOR FRONTAL (7119)	7119-9
			SOPORTE PARA MOTOR TRASERO	7122
			SOPORTE PARA MOTOR DERECHO	7121-H
			SOPORTE PARA TRANSMISIÓN AUT.	7054
V6 3.8 V6 4.0	08-10		SOPORTE PARA MOTOR FRONTAL	7279
			SOPORTE PARA MOTOR TRASERO	7310
			REPUESTO PARA SOPORTE DE MOTOR FRONTAL	7716-9
			REPUESTO PARA SOPORTE MOTOR TRASERO	7723-9

**SOPORTES
TRANSMISSION & MOTOR MOUNTS**

6950

7012

7012-9

7028

7028-9

7054

7119

7119-9

7121-H

7122

7279

7310

7716-9

7723-9
NUEVO
NUEVO

CONTINUACIÓN... CARAVAN

28	APLICACIÓN / DESCRIPTION	DAI PARTS #	DAI KIT PARTS #
BASES PARA AMORTIGUADOR / STRUT MOUNTS			
84-90	BASE PARA AMORTIGUADOR FRONTAL IZQUIERDA Y DERECHA	6641	6758-KIT
	BALERO PARA BASES DE AMORTIGUADOR 6641 Y 6758-KIT	6141	
84-95	BASE PARA AMORTIGUADOR FRONTAL IZQUIERDA Y DERECHA	6636	
	BASE PARA AMORTIGUADOR FRONTAL IZQUIERDA Y DERECHA	6650	6650-KIT
	BALERO PARA BASES DE AMORTIGUADOR 6636, 6650 Y 6650-KIT	6140	
96-00	BASE PARA AMORTIGUADOR FRONTAL IZQUIERDA Y DERECHA	7015	7015-KIT
01-07	BASE PARA AMORTIGUADOR FRONTAL IZQUIERDA Y DERECHA	7051	7051-KIT

BASES PARA AMORTIGUADOR STRUT MOUNTS

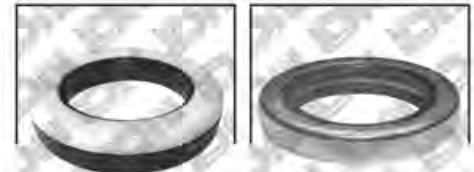

6140 6141



6636 6641



6650



6650-KIT



6758-KIT



7015



7015-KIT



7051



7051-KIT

28	APLICACIÓN / DESCRIPTION	DAI PARTS #
CUBRE POLVOS / C.V. BOOTS		
91-00	CUBRE POLVO IZQUIERDO Y DERECHO LADO RUEDA	6394

CUBRE POLVO C.V. BOOTS



6394



CONTINUACIÓN... CARAVAN

	28	APLICACIÓN / DESCRIPTION	DAI PARTS #
CUBRE POLVOS / C.V. BOOTS			
	91-00	CUBRE POLVO DERECHO LADO CAJA	6391
	96-00	CUBRE POLVO IZQUIERDO Y DERECHO LADO CAJA (CON TRIPOIDE)	6310

6391

6310
6310
MISCELÁNEOS / AUTOMOTIVE RUBBER PARTS

	91-05	GOMA PARA BARRA ESTABILIZADORA	64717
	84-90	GOMA PARA TIRANTE DE SUSPENSIÓN	64490
	96-07	TORNILLO ESTABILIZADOR FRONTAL	DAI-K-7258
		BUJE PARA HORQUILLA GRANDE	DAI-1406012
	01-07	BUJE PARA HORQUILLA INFERIOR CHICO	DAI-4689120
		BUJE PARA HORQUILLA GRANDE	DAI-1406014
	08-11	BUJE PARA HORQUILLA INFERIOR CHICO	DAI-1406048
		BUJE PARA HORQUILLA INFERIOR GRANDE	DAI-1406055

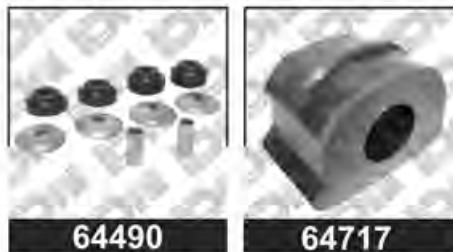
DAI-1406014
DAI-4689120
DAI-1406048
DAI-1406055
**MISCELÁNEOS
AUTOMOTIVE RUBBER PARTS**

64490
64717

DAI-K-7258
DAI-1406012

CARGO VAN

		APLICACIÓN / DESCRIPTION	DAI PARTS #
SOPORTES / TRANSMISSION & MOTOR MOUNTS			
V6 3.6	12-15	SOPORTE PARA MOTOR DERECHO	7567-H

**SOPORTES
TRANSMISSION & MOTOR MOUNTS**

7567-H

CHALLENGER

SOPORTES / TRANSMISSION & MOTOR MOUNTS			
V8 5.7	05-11	SOPORTE PARA MOTOR IZQUIERDO Y DERECHO	7698-H

SOPORTES TRANSMISSION & MOTOR MOUNTS

7698-H

		APLICACIÓN / DESCRIPTION	DAI PARTS #	DAI KIT PARTS #
BASES PARA AMORTIGUADOR / STRUT MOUNTS				
09-14		BASE PARA AMORTIGUADOR FRONTAL IZQUIERDA		7593-KIT
		BASE PARA AMORTIGUADOR FRONTAL DERECHA		7594-KIT

**BASES PARA AMORTIGUADOR
STRUT MOUNTS**

7593-KIT

7594-KIT

		APLICACIÓN / DESCRIPTION	DAI PARTS #
MISCELÁNEOS / AUTOMOTIVE RUBBER PARTS			
	09-14	BUJE PARA HORQUILLA INFERIOR	DAI-1406091

**MISCELÁNEOS
AUTOMOTIVE RUBBER PARTS**

DAI-1406091



CHARGER

		APLICACIÓN / DESCRIPTION	DAI PARTS #
SOPORTES / TRANSMISSION & MOTOR MOUNTS			
V6 2.7 V6 3.5	06-10	SOPORTE PARA MOTOR IZQUIERDO Y DERECHO	7442-H
V8 5.2	67-72	SOPORTE PARA TRANSMISIÓN STD. Y AUT.	1648
V8 5.9	67-72	SOPORTE PARA MOTOR IZQUIERDO	1761
V8 7.2		SOPORTE PARA MOTOR IZQUIERDO	1664
V8 5.7 V8 6.1	05-11	SOPORTE PARA MOTOR IZQUIERDO Y DERECHO	7698-H



		APLICACIÓN / DESCRIPTION	DAI PARTS #	DAI KIT PARTS #
BASES PARA AMORTIGUADOR / STRUT MOUNTS				
06-15		BASE PARA AMORTIGUADOR FRONTAL IZQUIERDA		7593-KIT
		BASE PARA AMORTIGUADOR FRONTAL DERECHA		7594-KIT



		APLICACIÓN / DESCRIPTION	DAI PARTS #
MISCELÁNEOS / AUTOMOTIVE RUBBER PARTS			
	65-72	TORNILLO EXCENTRICO	64600



CONTINUACIÓN... CHARGER

  28		APLICACIÓN / DESCRIPTION	DAI PARTS #
MISCELÁNEOS / AUTOMOTIVE RUBBER PARTS			
70-72	TORNILLO ESTABILIZADOR (5", 1542.4 mm)		6100
	TORNILLO ESTABILIZADOR (5", 1542.4 mm EQUIPO ORIGINAL)		6104
73-79	GOMA PARA TIRANTE DE SUSPENSIÓN		64570
83-87	GOMA PARA TIRANTE DE SUSPENSIÓN		64490
06-14	BUJE PARA HORQUILLA INFERIOR		DAI-1406091

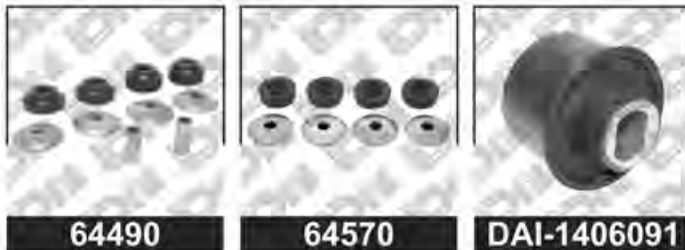

CIRRUS

SOPORTES / TRANSMISSION & MOTOR MOUNTS			
L4 2.0	2000	REPUESTO PARA SOPORTE DE MOTOR FRONTAL (6698, 6900 Y 6901)	6787
		SOPORTE PARA MOTOR FRONTAL CON DISTANCIA ENTRE TUERCAS DE FIJACIÓN A 92 mm	6900
		SOPORTE PARA MOTOR FRONTAL CON DISTANCIA ENTRE TUERCAS DE FIJACIÓN A 76 mm	6901
		SOPORTE PARA MOTOR DERECHO	6851
		SOPORTE PARA TRANSMISIÓN	6849



CONTINUACIÓN... CIRRUS

 		APLICACIÓN / DESCRIPTION	DAI PARTS #	SOPORTES TRANSMISSION & MOTOR MOUNTS	
L4 2.4	96-00	SOPORTE PARA MOTOR FRONTAL Y TRASERO (PUENTE)	6698		
		REPUESTO PARA SOPORTE DE MOTOR TRASERO (6698 Y 6899)	6785	6698	6785
		REPUESTO PARA SOPORTE DE MOTOR FRONTAL (6698, 6900 Y 6901)	6787		
	96-06	SOPORTE PARA TRANSMISIÓN	6849	6787	6849
		SOPORTE PARA MOTOR DERECHO	6851		
	01-06	SOPORTE PARA MOTOR TRASERO TURBO AUT.	7018	6851	6900
		SOPORTE PARA TRANSMISIÓN	6849		
		SOPORTE PARA MOTOR FRONTAL TURBO AUT.	7068	7018	7068
	07-11	SOPORTE PARA MOTOR FRONTAL	7279		
		REPUESTO PARA SOPORTE DE MOTOR FRONTAL Y TRASERO (BUJE INTERNO GRANDE OVALADO) (7279 Y 7310)	7279-9	7279	7279-9
		SOPORTE PARA MOTOR TRASERO	7310		
		SOPORTE PARA MOTOR DERECHO	7329-H		
		SOPORTE PARA TRANSMISIÓN	7337		
		REPUESTO PARA SOPORTE DE TRANSMISIÓN (7337)	7337-9		
V6 2.5	96-00	SOPORTE PARA MOTOR FRONTAL Y TRASERO (PUENTE)	6698		
		REPUESTO PARA SOPORTE DE MOTOR TRASERO (6698 Y 6899)	6785	6698	6785
		REPUESTO PARA SOPORTE DE MOTOR FRONTAL (6698, 6900 Y 6901)	6787		
		SOPORTE PARA TRANSMISIÓN	6849	6787	6849
				7279	7279-9



CONTINUACIÓN... CIRRUS

 		APLICACIÓN / DESCRIPTION	DAI PARTS #
SOPORTES / TRANSMISSION & MOTOR MOUNTS			
V6 2.5	96-00	SOPORTE PARA MOTOR DERECHO	6851
		SOPORTE PARA MOTOR TRASERO	6899
		SOPORTE PARA MOTOR FRONTAL CON DISTANCIA ENTRE TUERCAS DE FIJACIÓN A 92 mm	6900
		SOPORTE PARA MOTOR FRONTAL CON DISTANCIA ENTRE TUERCAS DE FIJACIÓN A 76 mm	6901
V6 2.7	97-00	REPUESTO PARA SOPORTE DE MOTOR TRASERO (6698 Y 6899)	6785
		REPUESTO PARA SOPORTE DE MOTOR FRONTAL (6698, 6900 Y 6901)	6787
		SOPORTE PARA TRANSMISIÓN	6849
		SOPORTE PARA MOTOR DERECHO	6851
		SOPORTE PARA MOTOR TRASERO	6899
		SOPORTE PARA MOTOR FRONTAL CON DISTANCIA ENTRE TUERCAS DE FIJACIÓN A 92 mm	6900
		SOPORTE PARA MOTOR FRONTAL CON DISTANCIA ENTRE TUERCAS DE FIJACIÓN A 76 mm	6901



CONTINUACIÓN... CIRRUS



28	APLICACIÓN / DESCRIPTION	DAI PARTS #	DAI KIT PARTS #
BASES PARA AMORTIGUADOR / STRUT MOUNTS			
95-00	BASE DE AMORTIGUADOR FRONTAL IZQUIERDA Y DERECHA <i>COUPE</i>	6755	
	BASE DE AMORTIGUADOR FRONTAL IZQUIERDA Y DERECHA	6736	6736-KIT
	BASE PARA AMORTIGUADOR TRASERA IZQUIERDA Y DERECHA	6750	6750-KIT
01-06	BASE PARA AMORTIGUADOR FRONTAL IZQUIERDA Y DERECHA <i>COUPE</i>		7319-KIT
07-11	BASE DE AMORTIGUADOR FRONTAL IZQUIERDA Y DERECHA	7332	
07-14	BASE PARA AMORTIGUADOR FRONTAL IZQUIERDA Y DERECHA		7596-KIT



28	APLICACIÓN / DESCRIPTION	DAI PARTS #
CUBRE POLVOS / C.V. BOOTS		
95-08	CUBRE POLVO DERECHO LADO CAJA (CON TRIPOIDE)	6310
	CUBRE POLVO IZQUIERDO LADO CAJA (CON TRIPOIDE)	6398



CONTINUACIÓN... CIRRUS

	 28	APLICACIÓN / DESCRIPTION	DAI PARTS #
MISCELÁNEOS / AUTOMOTIVE RUBBER PARTS			
95-00		GOMA PARA CREMALLERA DE DIRECCIÓN HID. (DERECHA PAR 713)	712
		GOMA PARA CREMALLERA DE DIRECCIÓN HID. (IZQUIERDA PAR 712)	713
		GOMA PARA BARRA ESTABILIZADORA	64737
95-06		TORNILLO ESTABILIZADOR	4695626
96-06		BUJE PARA HORQUILLA INFERIOR CHICO	DAI-4616939
01-06		TORNILLO ESTABILIZADOR FRONTAL IZQUIERDO <i>COUPE</i>	DAI-2115001
		TORNILLO ESTABILIZADOR FRONTAL DERECHO <i>COUPE</i>	DAI-2115002
07-11		KIT DE BUJES PARA SUSPENSIÓN TRASERA EN POLIURETANO 4 BUJES CHICOS, D. INT. 0.480" D. EXT. 1.575", ALTURA 1.650" 2 BUJES GRANDES D. INT. 0.480" D. EXT. 1.655", ALTURA 1.650"	9802
		BUJE PARA SUSPENSIÓN TRASERA GRANDE D. INT. 0.480" D. EXT. 1.655" ALTURA 1.650"	9802-1
		BUJE CHICO PARA SUSPENSIÓN TRASERA D. INT. 0.480" D. EXT. 1.575" ALTURA 1.650	9802-2
		BUJE PARA HORQUILLA INFERIOR CHICO	DAI-1406048
		BUJE PARA HORQUILLA INFERIOR GRANDE	DAI-1406055
07-14		TORNILLO ESTABILIZADOR	DAI-2106016

**MISCELÁNEOS
AUTOMOTIVE RUBBER PARTS**



712 713



9802 9802-1



9802-2 64737



4695626 DAI-1406048



DAI-1406055 DAI-2115001





DAI-2115002 DAI-2106016 DAI-4616939



CONCORDE

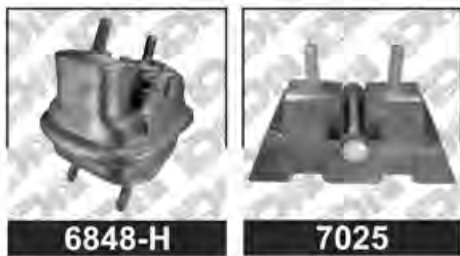

  28		APLICACIÓN / DESCRIPTION	DAI PARTS #
SOPORTES / TRANSMISSION & MOTOR MOUNTS			
V6 2.7	98-04	SOPORTE PARA TRANSMISIÓN	7025
V6 3.2	98-01		
V6 3.3 V6 3.5	93-02	SOPORTE PARA TRANSMISIÓN	6695
		SOPORTE PARA TRANSMISIÓN (TIPO ORIGINAL)	6840
		SOPORTE PARA MOTOR IZQUIERDO Y DERECHO	6848-H



 28		APLICACIÓN / DESCRIPTION	DAI PARTS #	DAI KIT PARTS #
BASES PARA AMORTIGUADOR / STRUT MOUNTS				
93-97	BASE PARA AMORTIGUADOR TRASERA IZQUIERDA Y DERECHA	6744	6744-KIT	
	BASE PARA AMORTIGUADOR FRONTAL IZQUIERDA Y DERECHA	6745	6745-KIT	
98-05	BASE PARA AMORTIGUADOR TRASERA IZQUIERDA Y DERECHA		7230-KIT	
	BASE PARA AMORTIGUADOR FRONTAL IZQUIERDA Y DERECHA		7341-KIT	



CONTINUACIÓN... CONCORDE

		APLICACIÓN / DESCRIPTION	DAI PARTS #
MISCELÁNEOS / AUTOMOTIVE RUBBER PARTS			
93-97		TOPE PARA AMORTIGUADOR FRONTAL IZQUIERDO Y DERECHO	D-0619
		TORNILLO ESTABILIZADOR FRONTRAL	DAI-K-7197
98-05		TORNILLO ESTABILIZADOR FRONTRAL	DAI-2106008



CORDOBA

MISCELÁNEOS / AUTOMOTIVE RUBBER PARTS

62-72	TORNILLO ESTABILIZADOR (6", 177.8 mm)	6101
	TORNILLO ESTABILIZADOR (6", 177.800 mm EQUIPO ORIGINAL)	6105
62-76	TORNILLO EXCENTRICO	64600
	GOMA PARA TIRANTE DE SUSPENSIÓN	64570
73-76	TORNILLO ESTABILIZADOR (5", 1542.4 mm)	6100
	TORNILLO ESTABILIZADOR (5", 1542.4 mm EQUIPO ORIGINAL)	6104
77-82	TORNILLO ESTABILIZADOR FRONTAL IZQUIERDO Y DERECHO (CORTO)	6098
	TORNILLO ESTABILIZADOR	64590

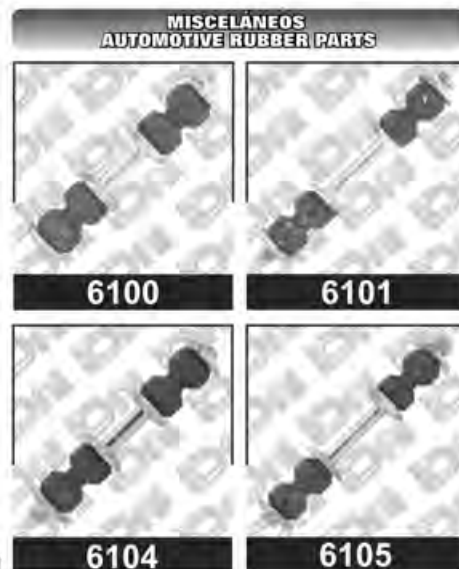

CORONET

		APLICACIÓN / DESCRIPTION	DAI PARTS #
SOPORTES / TRANSMISSION & MOTOR MOUNTS			
L6 2.8 L6 3.7	64-67	SOPORTE PARA TRANSMISIÓN STD. Y AUT.	1648
		SOPORTE PARA MOTOR DERECHO	1659
V8 5.2 V8 5.9 V8 7.2	67-72	SOPORTE PARA TRANSMISIÓN STD. Y AUT.	1648
		SOPORTE PARA MOTOR IZQUIERDO	1664
		SOPORTE PARA MOTOR IZQUIERDO	1761



MISCELÁNEOS / AUTOMOTIVE RUBBER PARTS		
65-72	TORNILLO EXCENTRICO	64600
70-82	TORNILLO ESTABILIZADOR (5", 1542.4 mm)	6100
	TORNILLO ESTABILIZADOR (5", 1542.4 mm EQUIPO ORIGINAL)	6104
73-79	GOMA PARA TIRANTE DE SUSPENSIÓN	64570
83-87	GOMA PARA TIRANTE DE SUSPENSIÓN	64490

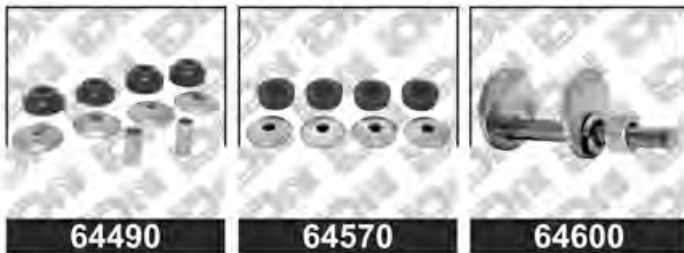
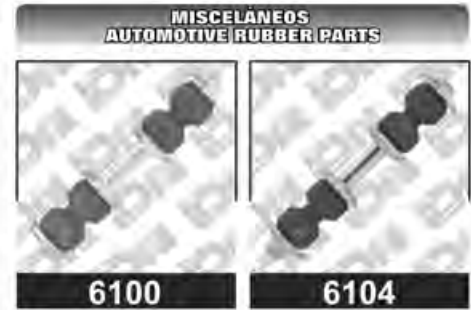

CROSSFIRE

 		APLICACIÓN / DESCRIPTION	DAI PARTS #
SOPORTES / TRANSMISSION & MOTOR MOUNTS			
V6 3.2	04-06	SOPORTE PARA TRANSMISIÓN AUT.	7466



D-100

SOPORTES / TRANSMISSION & MOTOR MOUNTS			
L6 2.8	61-74	SOPORTE PARA MOTOR DERECHO	1658
L6 3.7	75-94	SOPORTE PARA TRANSMISIÓN	1776
		SOPORTE PARA MOTOR IZQUIERDO Y DERECHO	1796
L4 4.0 V6 3.9 V8 5.7	75-94	SOPORTE PARA TRANSMISIÓN	1776
		SOPORTE PARA MOTOR IZQUIERDO Y DERECHO	1796
		SOPORTE PARA MOTOR IZQUIERDO Y DERECHO	1796
V8 5.2	69-80	SOPORTE PARA MOTOR IZQUIERDO Y DERECHO	1761
	69-94	SOPORTE PARA TRANSMISIÓN	1776
	75-94	SOPORTE PARA MOTOR IZQUIERDO Y DERECHO	1796
		SOPORTE PARA TRANSMISIÓN	6653
	69-80	REPUESTO PARA SOPORTE TRANSMISIÓN (1776)	2353
V8 5.9	69-80	SOPORTE PARA MOTOR IZQUIERDO Y DERECHO	1761
		REPUESTO PARA SOPORTE TRANSMISIÓN (1776)	2353
	69-94	SOPORTE PARA TRANSMISIÓN	1776
	75-94	SOPORTE PARA TRANSMISIÓN	6653
V8 7.2	75-94	SOPORTE PARA TRANSMISIÓN	1776
		SOPORTE PARA TRANSMISIÓN	6653



CONTINUACIÓN.. D-100

28		APLICACIÓN / DESCRIPTION	DAI PARTS #	MISCELÁNEOS / AUTOMOTIVE RUBBER PARTS	
MISCELÁNEOS / AUTOMOTIVE RUBBER PARTS					
72-93		TORNILLO ESTABILIZADOR (LARGO)	6099		
		GOMA PARA TIRANTE DE SUSPENSIÓN	64500		
		TORNILLO EXCENTRICO	64600		
		BRAZO AUXILIAR DE DIRECCIÓN	DAI-7055		



64600
DAI-7055
D-150

SOPORTES / TRANSMISSION & MOTOR MOUNTS				SOPORTES TRANSMISSION & MOTOR MOUNTS	
L6 3.7 V8 5.2	75-94	SOPORTE PARA TRANSMISIÓN	1776		
		SOPORTE PARA MOTOR IZQUIERDO Y DERECHO	1796		
		SOPORTE PARA MOTOR IZQUIERDO Y DERECHO	1799		
		REPUESTO PARA SOPORTE TRANSMISIÓN (1776)	2353		
L6 4.0 V6 3.9 V8 5.7	75-94	SOPORTE PARA TRANSMISIÓN	1776		
		SOPORTE PARA MOTOR IZQUIERDO Y DERECHO	1796		
V8 5.9 V8 7.2	75-94	SOPORTE PARA TRANSMISIÓN	1776		
		SOPORTE PARA MOTOR IZQUIERDO Y DERECHO	1799		
		REPUESTO PARA SOPORTE TRANSMISIÓN (1776)	2353		

1776
1796
1799
2353

CONTINUACIÓN... D-150

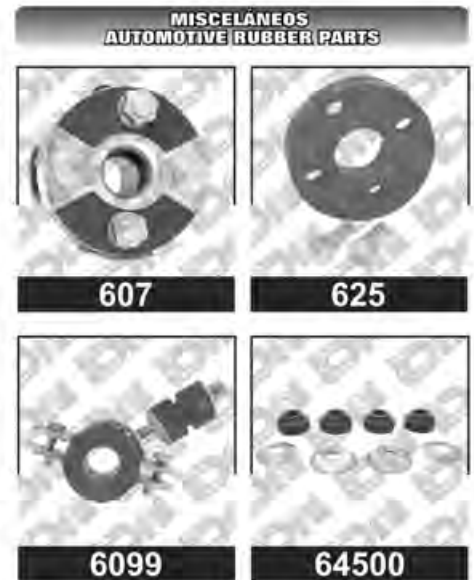
		APLICACIÓN / DESCRIPTION	DAI PARTS #
MISCELÁNEOS / AUTOMOTIVE RUBBER PARTS			
72-93		TORNILLO ESTABILIZADOR (LARGO)	6099
		GOMA PARA TIRANTE DE SUSPENSIÓN	64500
		TORNILLO EXCENTRICO	64600
91-08		GALLETAS PARA DIRECCIÓN (4 PERNOS COPLEROS CHICOS 2 5/8" COMPLETO 607 Y 617 NACIONALES Y AMERICANOS)	625
91-08		COPLEROS PARA DIRECCIÓN CHICO 2 5/8" (SINFÍN DE .725 mm)	607
72-93		BRAZO AUXILIAR DE DIRECCIÓN	DAI-7055



D-200

		SOPORTES / TRANSMISSION & MOTOR MOUNTS	
L6 3.7	75-94	SOPORTE PARA TRANSMISIÓN STD.	1776
		SOPORTE PARA MOTOR IZQUIERDO Y DERECHO	1799
		REPUESTO PARA SOPORTE TRANSMISIÓN (1776)	2353
		SOPORTE PARA MOTOR IZQUIERDO Y DERECHO	1796



CONTINUACIÓN... D-200

	28	APLICACIÓN / DESCRIPTION	DAI PARTS #
SOPORTES / TRANSMISSION & MOTOR MOUNTS			
L6 4.0 V6 3.9 V8 5.7	75-94	SOPORTE PARA TRANSMISIÓN STD.	1776
		SOPORTE PARA MOTOR IZQUIERDO Y DERECHO	1796

V8 5.2 V8 5.9	69-80	SOPORTE PARA MOTOR IZQUIERDO Y DERECHO	1761
	69-94	SOPORTE PARA TRANSMISIÓN STD.	1776
		REPUESTO PARA SOPORTE TRANSMISIÓN (1776)	2353
	75-94	SOPORTE PARA MOTOR IZQUIERDO Y DERECHO	1796
		SOPORTE PARA MOTOR IZQUIERDO Y DERECHO	1799
	SOPORTE PARA TRANSMISIÓN	6653	

V8 7.2	75-94	SOPORTE PARA TRANSMISIÓN STD.	1776
		REPUESTO PARA SOPORTE TRANSMISIÓN (1776)	2353
		SOPORTE PARA TRANSMISIÓN	6653
		SOPORTE PARA MOTOR IZQUIERDO Y DERECHO	1799

**SOPORTES
TRANSMISSION & MOTOR MOUNTS**

1761

1776

1796

1799

2353

6653
MISCELÁNEOS / AUTOMOTIVE RUBBER PARTS

	72-93	TORNILLO ESTABILIZADOR (LARGO)	6099
		GOMA PARA TIRANTE DE SUSPENSIÓN (131", 149", WB 3000, 3300)	64500
		TORNILLO EXCENTRICO (131"WB, 3000, 3300)	64600
		BRAZO AUXILIAR DE DIRECCIÓN	DAI-7055

**MISCELÁNEOS
AUTOMOTIVE RUBBER PARTS**

6099

64500

64600

DAI-7055

D-250

  28		APLICACIÓN / DESCRIPTION	DAI PARTS #
SOPORTES / TRANSMISSION & MOTOR MOUNTS			
L6 3.7 L6 4.0 V6 3.9 V8 5.2 V8 5.7	75-94	SOPORTE PARA TRANSMISIÓN	1776
		SOPORTE PARA MOTOR IZQUIERDO Y DERECHO	1796



MISCELÁNEOS / AUTOMOTIVE RUBBER PARTS

	72-93	GOMA PARA TIRANTE DE SUSPENSIÓN (165" BW 4000)	64500
		TORNILLO EXCENTRICO (131"WB, 3000, 3300)	64600
		BRAZO DE DIRECCIÓN DE DIRECCIÓN	DAI-7055



D-300

SOPORTES / TRANSMISSION & MOTOR MOUNTS

L6 3.7	75-94	SOPORTE PARA TRANSMISIÓN	1776
--------	-------	--------------------------	------



CONTINUACIÓN... D-300

  28		APLICACIÓN // DESCRIPTION	DAI PARTS #
SOPORTES / TRANSMISSION & MOTOR MOUNTS			
L6 3.7	75-94	SOPORTE PARA MOTOR IZQUIERDO Y DERECHO	1796
		SOPORTE PARA MOTOR IZQUIERDO Y DERECHO	1799
		REPUESTO PARA SOPORTE TRANSMISIÓN (1776)	2353
L6 4.0 V6 3.9 V8 5.7	75-94	SOPORTE PARA TRANSMISIÓN	1776
		SOPORTE PARA MOTOR IZQUIERDO Y DERECHO	1796
V8 5.9	69-80	SOPORTE PARA MOTOR IZQUIERDO Y DERECHO	1761
	69-94	SOPORTE PARA TRANSMISIÓN	1776
		REPUESTO PARA SOPORTE TRANSMISIÓN (1776)	2353
	75-94	SOPORTE PARA MOTOR IZQUIERDO Y DERECHO	1799
		SOPORTE PARA TRANSMISIÓN	6653
V8 5.2	69-80	SOPORTE PARA MOTOR IZQUIERDO Y DERECHO	1761
	69-94	SOPORTE PARA TRANSMISIÓN	1776
		REPUESTO PARA SOPORTE TRANSMISIÓN (1776)	2353
	75-94	SOPORTE PARA MOTOR IZQUIERDO Y DERECHO	1796
		SOPORTE PARA MOTOR IZQUIERDO Y DERECHO	1799
		SOPORTE PARA TRANSMISIÓN	6653
V8 7.2	75-94	SOPORTE PARA TRANSMISIÓN	1776
		SOPORTE PARA MOTOR IZQUIERDO Y DERECHO	1799
		REPUESTO PARA SOPORTE TRANSMISIÓN (1776)	2353
		SOPORTE PARA TRANSMISIÓN	6653

**SOPORTES
TRANSMISSION & MOTOR MOUNTS**

1761

1776

1796

1799

2353

6653

CONTINUACIÓN... D-300

 		APLICACIÓN / DESCRIPTION	DAI PARTS #
MISCELÁNEOS / AUTOMOTIVE RUBBER PARTS			
72-93		TORNILLO ESTABILIZADOR (LARGO)	6099
		GOMA PARA TIRANTE DE SUSPENSIÓN	64500
		TORNILLO EXCENTRICO (131"WB, 3000, 3300)	64600
		BRAZO AUXILIAR DE DIRECCIÓN	DAI-7055



D-350

SOPORTES / TRANSMISSION & MOTOR MOUNTS			
L6 3.7 L6 4.0 V6 3.9 V8 5.7	75-94	SOPORTE PARA TRANSMISIÓN	1776
		SOPORTE PARA MOTOR IZQUIERDO Y DERECHO	1796
V8 5.9 V8 7.2	75-94	SOPORTE PARA TRANSMISIÓN STD.	1776
		SOPORTE PARA MOTOR IZQUIERDO Y DERECHO	1898
		SOPORTE PARA MOTOR IZQUIERDO Y DERECHO	1899
		SOPORTE PARA TRANSMISIÓN	6653



CONTINUACIÓN... D-350

 		APLICACIÓN / DESCRIPTION	DAI PARTS #
SOPORTES / TRANSMISSION & MOTOR MOUNTS			
V8 5.2	75-94	SOPORTE PARA TRANSMISIÓN	1776
		SOPORTE PARA MOTOR IZQUIERDO Y DERECHO	1796
		SOPORTE PARA MOTOR IZQUIERDO Y DERECHO	1898
		SOPORTE PARA MOTOR IZQUIERDO Y DERECHO	1899
		SOPORTE PARA TRANSMISIÓN	6653



MISCELÁNEOS / AUTOMOTIVE RUBBER PARTS		
91-08	COPLE PARA DIRECCIÓN CHICO 2 5/8" (SINFÍN DE .725")	607
	GALLETAS PARA DIRECCIÓN (4 PERNOS COPLE CHICO 2 5/8" COMPLETO 607 Y 617 NACIONALES Y AMERICANOS)	625
72-93	TORNILLO ESTABILIZADOR (LARGO)	6099
	GOMA PARA TIRANTE DE SUSPENSIÓN	64500
	BRAZO AUXILIAR DE DIRECCIÓN	DAI-7055
	TORNILLO EXCENTRICO	64600



DAKOTA

		APLICACIÓN / DESCRIPTION	DAI PARTS #
--	--	--------------------------	-------------

SOPORTES / TRANSMISSION & MOTOR MOUNTS

V6 3.7	05-11	SOPORTE PARA TRANSMISIÓN (4X4)	7584
V8 4.7	05-09		
V6 3.9	89-96	SOPORTE PARA MOTOR IZQUIERDO	6934
	91-96	SOPORTE PARA TRANSMISIÓN STD.	7242
V8 4.7 V8 5.9	98-04	SOPORTE PARA TRANSMISIÓN	7174
		SOPORTE PARA MOTOR IZQUIERDO	7175
		SOPORTE PARA MOTOR DERECHO	7253
V8 5.2	89-96	SOPORTE PARA MOTOR IZQUIERDO	6934
	92-93	SOPORTE PARA TRANSMISIÓN	1894
		SOPORTE PARA TRANSMISIÓN (4X4)	6831
		SOPORTE PARA TRANSMISIÓN	6833
	94-98	SOPORTE PARA TRANSMISIÓN STD.	7242
97-99	SOPORTE PARA TRANSMISIÓN STD. Y AUT.	7243	
V8 5.9	98-03	SOPORTE PARA TRANSMISIÓN STD. Y AUT.	7243

SOPORTES TRANSMISSION & MOTOR MOUNTS



MISCELÁNEOS / AUTOMOTIVE RUBBER PARTS

	01-09	GOMA PARA BARRA ESTABILIZADORA	64692
--	-------	--------------------------------	-------

MISCELÁNEOS AUTOMOTIVE RUBBER PARTS



DART

 		APLICACIÓN / DESCRIPTION	DAI PARTS #
SOPORTES / TRANSMISSION & MOTOR MOUNTS			
L6 2.8	73-84	SOPORTE PARA MOTOR IZQUIERDO	1764
		SOPORTE PARA TRANSMISIÓN STD. Y AUT.	1775
L6 2.8 L6 3.7	63-72	SOPORTE PARA MOTOR DERECHO AUT.	1647
		SOPORTE PARA TRANSMISIÓN STD. Y AUT.	1648
	67-72	SOPORTE PARA MOTOR IZQUIERDO	1664
	73-82	SOPORTE PARA MOTOR DERECHO	1763
		REPUESTO PARA SOPORTE MOTOR DERECHO (1763)	2350
REPUESTO PARA SOPORTE DE TRANSMISIÓN STD. Y AUT. (1762 Y 1775)		2349	
V8 5.2 V8 5.9	67-72	SOPORTE PARA MOTOR IZQUIERDO Y DERECHO	1743

SOPORTES TRANSMISSION & MOTOR MOUNTS



1647



1648



1664



1743



1763



1764



1775



2349



2350

CUBRE POLVOS / C.V. BOOTS

77-82	CUBRE POLVO IZQUIERDO Y DERECHO LADO RUEDA	6306
-------	--	------

CUBRE POLVO C.V. BOOTS



6306



CONTINUACIÓN... DART

		APLICACIÓN / DESCRIPTION	DAI PARTS #
MISCELÁNEOS / AUTOMOTIVE RUBBER PARTS			
62-72		TORNILLO ESTABILIZADOR (6", 177.8 mm)	6101
		TORNILLO ESTABILIZADOR (6", 177.8 mm EQUIPO ORIGINAL)	6105
62-76		TORNILLO EXCENTRICO	64600
		GOMA PARA TIRANTE DE SUSPENSIÓN	64570
77-82		TOPE PARA AMORTIGUADOR FRONTAL IZQUIERDO Y DERECHO	D-0622
		TORNILLO ESTABILIZADOR FRONTAL IZQUIERDO Y DERECHO (CORTO)	6098
73-76		TORNILLO ESTABILIZADOR (5", 1542.4 mm)	6100
		TORNILLO ESTABILIZADOR (5", 1542.4 mm EQUIPO ORIGINAL)	6104
77-82		TORNILLO ESTABILIZADOR	64590

**MISCELÁNEOS
AUTOMOTIVE RUBBER PARTS**



D-0622



6098



6100



6101



6105



6104



64570



64590



64600

DART K

SOPORTES / TRANSMISSION & MOTOR MOUNTS			
L4 2.2 L4 2.5	85-88	SOPORTE PARA MOTOR DERECHO	1810
		SOPORTE PARA MOTOR FRONTAL	1910
		REPUESTO PARA SOPORTE DE MOTOR FRONTAL (1910)	1868



1868

**SOPORTES TRANSMISSION
& MOTOR MOUNTS**



1810



1910



CONTINUACIÓN... DART K

 		APLICACIÓN / DESCRIPTION	DAI PARTS #
SOPORTES / TRANSMISSION & MOTOR MOUNTS			
L4 2.2 L4 2.5	85-88	REPUESTO PARA SOPORTE DE TRANSMISIÓN (1827)	2354
		SOPORTE DE TORSIÓN TRASERO	1809



	APLICACIÓN / DESCRIPTION	DAI PARTS #	DAI KIT PARTS #
BASES PARA AMORTIGUADOR / STRUT MOUNTS			
82-83	BASE PARA AMORTIGUADOR FRONTAL IZQUIERDA Y DERECHA	1808	1808-KIT
84-85	BASE PARA AMORTIGUADOR FRONTAL IZQUIERDA Y DERECHA	1820	1820-KIT
84-88	BASE PARA AMORTIGUADOR FRONTAL IZQUIERDA Y DERECHA	6641	6758-KIT
	BALERO PARA BASE DE AMORTIGUADOR 6641 Y 6758-KIT	6141	
86-88	BASE PARA AMORTIGUADOR FRONTAL IZQUIERDA Y DERECHA	6636	
	BASE PARA AMORTIGUADOR FRONTAL IZQUIERDA Y DERECHA	6650	6650-KIT
	BALERO PARA BASE DE AMORTIGUADOR 6636, 6650 Y 6650-KIT	6140	



CONTINUACIÓN... DART K

  28		APLICACIÓN / DESCRIPTION	DAI PARTS #
MISCELÁNEOS / AUTOMOTIVE RUBBER PARTS			
82-88		CUBRE POLVO PARA PALANCA DE VELOCIDADES	6554
		TOPE PARA AMORTIGUADOR FRONTAL IZQUIERDO Y DERECHO	D-0619
		GOMA PARA CREMALLERA DE DIRECCIÓN IZQUIERDA Y DERECHA	711
		GOMA PARA BARRA ESTABILIZADORA	6423
		GOMA SUJETADORA DE ESCAPE (TIRANTE)	6548
		GOMA PARA TIRANTE DE SUSPENSIÓN	64490

**MISCELÁNEOS
AUTOMOTIVE RUBBER PARTS**



D-0619



711



6423



6548



6554

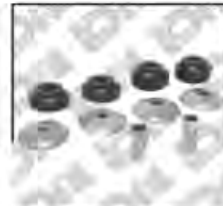

64490

DAYTONA

 28		APLICACIÓN / DESCRIPTION	DAI PARTS #	DAI KIT PARTS #
BASES PARA AMORTIGUADOR / STRUT MOUNTS				
84-93		BASE PARA AMORTIGUADOR FRONTAL IZQUIERDA Y DERECHA	6636	
		BASE PARA AMORTIGUADOR FRONTAL IZQUIERDA Y DERECHA	6650	6650-KIT
		BASE PARA AMORTIGUADOR FRONTAL IZQUIERDA Y DERECHA	6641	

**BASES PARA AMORTIGUADOR
STRUT MOUNTS**



6636



6650



6650-KIT



6641



CONTINUACIÓN... DAYTONA

28	APLICACIÓN / DESCRIPTION	DAI PARTS #	DAI KIT PARTS #
BASES PARA AMORTIGUADOR / STRUT MOUNTS			
84-93	BASE PARA AMORTIGUADOR FRONTAL IZQUIERDA Y DERECHA		6758-KIT
	BALERO PARA BASES DE AMORTIGUADOR 6636, 6650 Y 6650-KIT	6140	
	BALERO PARA BASES DE AMORTIGUADOR 6641 Y 6758-KIT	6141	

**BASES PARA AMORTIGUADOR
STRUT MOUNTS**

6140

6141

6758-KIT

28	APLICACIÓN / DESCRIPTION	DAI PARTS #
MISCELÁNEOS / AUTOMOTIVE RUBBER PARTS		
84-93	TOPE PARA AMORTIGUADOR FRONTAL IZQUIERDO Y DERECHO	D-0622
84-88	GOMA PARA TIRANTE DE SUSPENSIÓN	64490
89-93	TOPE PARA AMORTIGUADOR FRONTAL Y TRASERO IZQUIERDO Y DERECHO	D-0621

**MISCELÁNEOS
AUTOMOTIVE RUBBER PARTS**

D-0621

D-0622

64490

DINASTY

28		APLICACIÓN / DESCRIPTION	DAI PARTS #	DAI KIT PARTS #
BASES PARA AMORTIGUADOR / STRUT MOUNTS				
88-93		BASE PARA AMORTIGUADOR FRONTAL IZQUIERDA Y DERECHA	6636	
		BASE PARA AMORTIGUADOR FRONTAL IZQUIERDA Y DERECHA	6650	6650-KIT
		BALERO PARA BASE DE AMORTIGUADOR 6636, 6650 Y 6650-KIT	6140	



28		APLICACIÓN / DESCRIPTION	DAI PARTS #
MISCELÁNEOS / AUTOMOTIVE RUBBER PARTS			
88-93		TOPE PARA AMORTIGUADOR TRASERO IZQUIERDO Y DERECHO	D-0620



DURANGO

SOportes / TRANSMISSION & MOTOR MOUNTS			
V8 4.7	00-04	SOPORTE PARA TRANSMISIÓN	7174
V8 5.9		SOPORTE PARA MOTOR IZQUIERDO	7175



CONTINUACIÓN... DURANGO

		APLICACIÓN / DESCRIPTION	DAI PARTS #
SOPORTES / TRANSMISSION & MOTOR MOUNTS			
V8 4.7 V8 5.9	00-04	SOPORTE PARA MOTOR DERECHO	7253
V8 4.7 V8 3.7 V8 5.7	04-07	SOPORTE PARA TRANSMISIÓN AUT.	7463



MISCELÁNEOS / AUTOMOTIVE RUBBER PARTS			
	01-09	GOMA PARA BARRA ESTABILIZADORA (4X2)	64692
	05-09	BUJE PARA SOPORTE DIFERENCIAL	DAI-2906208

DUSTER

MISCELÁNEOS / AUTOMOTIVE RUBBER PARTS			
	62-72	TORNILLO ESTABILIZADOR (6", 177.8 mm)	6101
		TORNILLO ESTABILIZADOR (6", 177.8 mm EQUIPO ORIGINAL)	6105
	62-76	TORNILLO EXCENTRICO	64600
		GOMA PARA TIRANTE DE SUSPENSIÓN	64570



CONTINUACIÓN... DUSTER

	 28	APLICACIÓN / DESCRIPTION	DAI PARTS #
MISCELÁNEOS / AUTOMOTIVE RUBBER PARTS			
	73-76	TORNILLO ESTABILIZADOR (5", 1542.400 mm)	6100
		TORNILLO ESTABILIZADOR (5", 1542.4 mm EQUIPO ORIGINAL)	6104
	77-82	TORNILLO ESTABILIZADOR FRONTAL IZQUIERDO Y DERECHO (CORTO)	6098
		TORNILLO ESTABILIZADOR	64590



E CLASS

 28	APLICACIÓN / DESCRIPTION	DAI PARTS #	DAI KIT PARTS #
BASES PARA AMORTIGUADOR / STRUT MOUNTS			
83-84	BASE PARA AMORTIGUADOR FRONTAL IZQUIERDA Y DERECHA	6641	6758-KIT
	BALERO PARA BASE DE AMORTIGUADOR 6641 Y 6758-KIT	6141	



EUROPA

28	APLICACIÓN / DESCRIPTION	DAI PARTS #	DAI KIT PARTS #	BASES PARA AMORTIGUADOR STRUT MOUNTS	
BASES PARA AMORTIGUADOR / STRUT MOUNTS					
82-83	BASE PARA AMORTIGUADOR FRONTAL IZQUIERDA Y DERECHA	1808	1808-KIT		
				1808	1808-KIT
84-85	BASE PARA AMORTIGUADOR FRONTAL IZQUIERDA Y DERECHA	1820	1820-KIT		
				1820	1820-KIT
84-88	BASE PARA AMORTIGUADOR FRONTAL IZQUIERDA Y DERECHA	6641	6758-KIT		
	BALERO PARA BASE DE AMORTIGUADOR 6641 Y 6758-KIT	6141			
86-88	BASE PARA AMORTIGUADOR FRONTAL IZQUIERDA Y DERECHA	6636			
	BASE PARA AMORTIGUADOR FRONTAL IZQUIERDA Y DERECHA	6650	6650-KIT		
	BALERO PARA BASE DE AMORTIGUADOR 6636 Y 6650	6140			
				6140	6141
					
				6636	6641
					
				6650	6650-KIT
					
				6758-KIT	



CONTINUACIÓN... EUROPA

 28	APLICACIÓN / DESCRIPTION	DAI PARTS #
MISCELÁNEOS / AUTOMOTIVE RUBBER PARTS		
82-88	GOMA PARA TIRANTE DE SUSPENSIÓN	64490



EXECUTIVE

28	APLICACIÓN / DESCRIPTION	DAI PARTS #	DAI KIT PARTS #
BASES PARA AMORTIGUADOR / STRUT MOUNTS			
83-86	BASE PARA AMORTIGUADOR FRONTAL IZQUIERDA Y DERECHA	6641	6758-KIT
	BALERO PARA BASE DE AMORTIGUADOR 6641 Y 6758-KIT	6141	



GRAND CARAVAN

 28	APLICACIÓN / DESCRIPTION	DAI PARTS #
SOPORTES / TRANSMISSION & MOTOR MOUNTS		
V6 3.3 08-10	SOPORTE PARA MOTOR FRONTAL	7279
	SOPORTE PARA MOTOR TRASERO	7310





CONTINUACIÓN... GRAND CARAVAN

		APLICACIÓN / DESCRIPTION		DAI PARTS #	SOPORTES TRANSMISSION & MOTOR MOUNTS		
V6 3.3	08-10	REPUESTO PARA SOPORTE DE TRANSMISIÓN (7337)		7337-9			
		SOPORTE PARA TRANSMISIÓN AUT.		7426			
		SOPORTE PARA MOTOR DERECHO		7567-H			
		REPUESTO PARA SOPORTE DE MOTOR FRONTAL		7716-9			
		REPUESTO PARA SOPORTE DE MOTOR TRASERO		7723-9			
	90-95	SOPORTE PARA MOTOR FRONTAL		6651			
		REPUESTO PARA SOPORTE DE MOTOR FRONTAL (6651)		1927			
		SOPORTE PARA MOTOR DERECHO		6652			
	90-95	REPUESTO PARA SOPORTE MOTOR DERECHO (6652)		1973			
		SOPORTE PARA TRANSMISIÓN		6668			
		REPUESTO PARA SOPORTE DE TRANSMISIÓN (6668)		1928			
		SOPORTE PARA MOTOR DERECHO		6913			
	V6 3.6	11-13	SOPORTE PARA MOTOR FRONTAL		7279		
			SOPORTE PARA MOTOR TRASERO		7310		
SOPORTE PARA TRANSMISIÓN AUT.			7426				
11-15		SOPORTE PARA MOTOR DERECHO		7567-H			

7279	7310	7337-9	7426	7567-H	7716-9



CONTINUACIÓN... GRAND CARAVAN

 		APLICACIÓN / DESCRIPTION	DAI PARTS #
SOPORTES / TRANSMISSION & MOTOR MOUNTS			
V6 3.6	11-16	REPUESTO PARA SOPORTE DE TRANSMISIÓN (7337)	7337-9
V6 3.8	96-00	SOPORTE PARA MOTOR FRONTAL	6938
		REPUESTO PARA SOPORTE DE MOTOR FRONTAL Y TRANSMISIÓN (6938 Y 7012)	7012-9
		SOPORTE PARA MOTOR DERECHO	6942
		SOPORTE PARA TRANSMISIÓN	7012
		SOPORTE PARA TRANSMISIÓN AUT.	7028
		REPUESTO PARA SOPORTE DE TRANSMISIÓN (7028 Y 7054)	7028-9
	96-08	REPUESTO PARA SOPORTE DE MOTOR DERECHO (6942)	6950
	01-08	SOPORTE PARA MOTOR FRONTAL	7119
		REPUESTO PARA SOPORTE DE MOTOR FRONTAL (7119)	7119-9
		SOPORTE PARA MOTOR DERECHO	7121-H
		SOPORTE PARA MOTOR TRASERO	7122
	08-10	SOPORTE PARA TRANSMISIÓN AUT.	7054
		SOPORTE PARA MOTOR FRONTAL	7279
		SOPORTE PARA MOTOR TRASERO	7310

SOPORTES TRANSMISSION & MOTOR MOUNTS



6938 6942

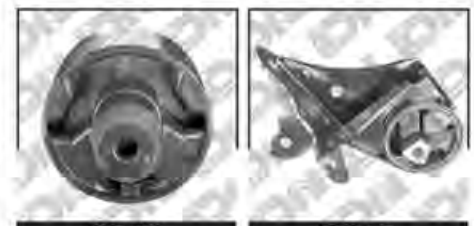

6950 7012

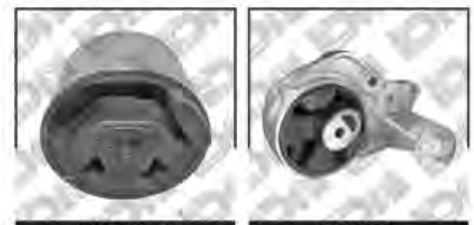

7012-9 7028



7028-9 7054



7119 7119-9 7121-H 7122

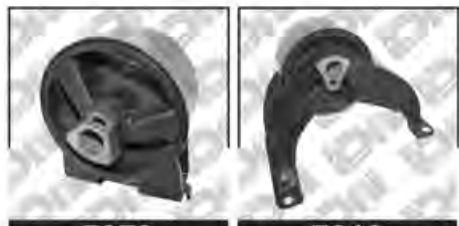

7279 7310



CONTINUACIÓN... GRAND CARAVAN

 		APLICACIÓN / DESCRIPTION	DAI PARTS #
SOPORTES / TRANSMISSION & MOTOR MOUNTS			
V6 3.8	08-10	REPUESTO PARA SOPORTE DE TRANSMISIÓN (7337)	7337-9
		SOPORTE PARA TRANSMISIÓN AUT.	7426
		REPUESTO PARA SOPORTE DE MOTOR FRONTAL	7716-9
		REPUESTO PARA SOPORTE DE MOTOR TRASERO	7723-9
V6 4.0	08-10	SOPORTE PARA MOTOR FRONTAL	7279
		REPUESTO PARA SOPORTE DE MOTOR FRONTAL	7716-9
		REPUESTO PARA SOPORTE DE TRANSMISIÓN (7337)	7337-9
		SOPORTE PARA MOTOR TRASERO	7310
		SOPORTE PARA TRANSMISIÓN AUT.	7426
		REPUESTO PARA SOPORTE DE MOTOR TRASERO	7723-9
	09-10	SOPORTE PARA MOTOR DERECHO	7567-H

**SOPORTES
TRANSMISSION & MOTOR MOUNTS**



7279



7310



7337-9



7426



7567-H



7716-9

NUEVO



7723-9

	APLICACIÓN / DESCRIPTION	DAI PARTS #	DAI KIT PARTS #
BASES PARA AMORTIGUADOR / STRUT MOUNTS			
84-90	BASE PARA AMORTIGUADOR FRONTAL IZQUIERDA Y DERECHA	6641	6758-KIT

**BASES PARA AMORTIGUADOR
STRUT MOUNTS**



6641





6758-KIT

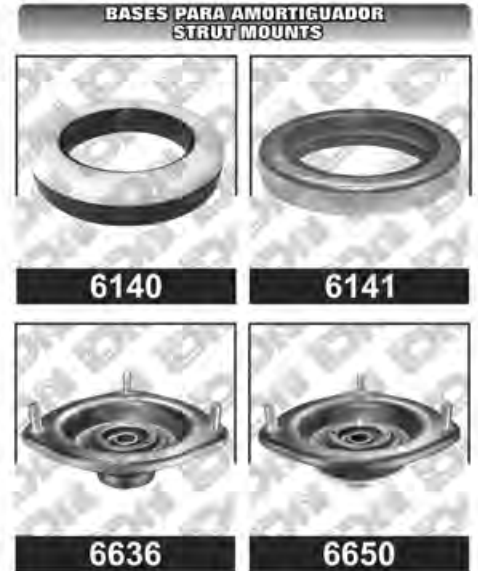

CONTINUACIÓN... GRAND CARAVAN

 28	APLICACIÓN / DESCRIPTION	DAI PARTS #	DAI KIT PARTS #
BASES PARA AMORTIGUADOR / STRUT MOUNTS			
84-90	BALERO PARA BASE DE AMORTIGUADOR 6641 Y 6758-KIT	6141	
84-95	BASE PARA AMORTIGUADOR FRONTAL IZQUIERDA Y DERECHA	6636	
	BASE PARA AMORTIGUADOR FRONTAL IZQUIERDA Y DERECHA	6650	6650-KIT
	BALERO PARA BASE DE AMORTIGUADOR 6636, 6650, 6650-KIT	6140	
96-00	BASE PARA AMORTIGUADOR FRONTAL IZQUIERDA Y DERECHA	7015	7015-KIT
01-07	BASE PARA AMORTIGUADOR FRONTAL IZQUIERDA Y DERECHA	7051	7051-KIT
08-14	BASE PARA AMORTIGUADOR FRONTAL IZQUIERDA Y DERECHA	7332	



 28	APLICACIÓN / DESCRIPTION	DAI PARTS #
MISCELÁNEOS / AUTOMOTIVE RUBBER PARTS		
84-90	GOMA PARA TIRANTE DE SUSPENSIÓN	64490
91-95	GOMA PARA BARRA ESTABILIZADORA	64717



CONTINUACIÓN.. GRAND CARAVAN

  28		APLICACIÓN / DESCRIPTION	DAI PARTS #
MISCELÁNEOS / AUTOMOTIVE RUBBER PARTS			
96-07	TORNILLO ESTABILIZADOR FRONTAL		DAI-K-7258
	BUJE PARA HORQUILLA		DAI-1406012
	BUJE PARA HORQUILLA INFERIOR CHICO		DAI-4689120
01-07	BUJE PARA HORQUILLA GRANDE		DAI-1406014
08-14	BUJE PARA HORQUILLA INFERIOR CHICO		DAI-1406048
	BUJE PARA HORQUILLA INFERIOR GRANDE		DAI-1406055
	TORNILLO ESTABILIZADOR FRONTAL		DAI-2106017

SOPORTES TRANSMISION & MOTOR MOUNTS

DAI-K-7258

DAI-1406012

DAI-1406014

DAI-1406048

DAI-1406055

DAI-2106017

DAI-4689120
GRAND VOYAGER
SOPORTES / TRANSMISSION & MOTOR MOUNTS

V6 3.3	90-95	SOPORTE PARA MOTOR FRONTAL	6651
		REPUESTO PARA SOPORTE DE MOTOR FRONTAL (6651)	1927
		SOPORTE PARA MOTOR DERECHO	6652
		REPUESTO PARA SOPORTE MOTOR DERECHO (6652)	1973

SOPORTES TRANSMISION & MOTOR MOUNTS

1927

1973

6651

6652

CONTINUACIÓN... GRAN VOYAGER

	28	APLICACIÓN / DESCRIPTION	DAI PARTS #
--	----	--------------------------	-------------

SOPORTES / TRANSMISSION & MOTOR MOUNTS

V6 3.3	90-95	SOPORTE PARA TRANSMISIÓN	6668
		REPUESTO PARA SOPORTE DE TRANSMISIÓN (6668)	1928
		SOPORTE PARA MOTOR DERECHO	6913
		SOPORTE PARA MOTOR DERECHO	6913-H

V6 3.8	96-00	SOPORTE PARA MOTOR FRONTAL	6938
		SOPORTE PARA MOTOR DERECHO	6942
		REPUESTO PARA SOPORTE DE MOTOR FRONTAL Y TRANSMISIÓN (6938 Y 7012)	7012-9
		SOPORTE PARA TRANSMISIÓN	7012
		SOPORTE PARA TRANSMISIÓN AUT.	7028
	96-08	REPUESTO PARA SOPORTE DE TRANSMISIÓN (7028 Y 7054)	7028-9
		REPUESTO PARA SOPORTE DE MOTOR DERECHO (6942)	6950
		01-08	SOPORTE PARA MOTOR FRONTAL
	REPUESTO PARA SOPORTE DE MOTOR FRONTAL (7119)		7119-9
	SOPORTE PARA MOTOR DERECHO	7121-H	

**SOPORTES
TRANSMISSION & MOTOR MOUNTS**



1928



6668



6913



6913-H



6938



6942

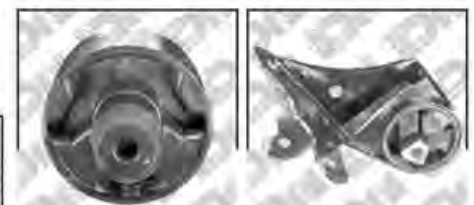

6950



7012

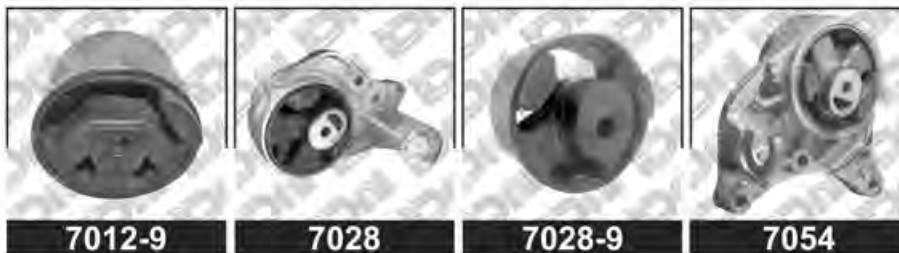

7012-9

7028

7028-9

7054



7119

7119-9

7121-H



CONTINUACIÓN... GRAN VOYAGER

 28	APLICACIÓN / DESCRIPTION	DAI PARTS #
--	---------------------------------	--------------------

SOPORTES / TRANSMISSION & MOTOR MOUNTS

V6 3.8	01-08	SOPORTE PARA MOTOR TRASERO	7122
		SOPORTE PARA TRANSMISIÓN AUT.	7054
V6 3.8 V6 4.0	08-10	SOPORTE PARA MOTOR DERECHO	7567-H
		REPUESTO PARA SOPORTE DE TRANSMISIÓN (7337)	7337-9
		SOPORTE PARA MOTOR FRONTAL	7279
		SOPORTE PARA MOTOR TRASERO	7310
		REPUESTO PARA SOPORTE DE MOTOR FRONTAL	7716-9
		REPUESTO PARA SOPORTE DE MOTOR TRASERO	7723-9

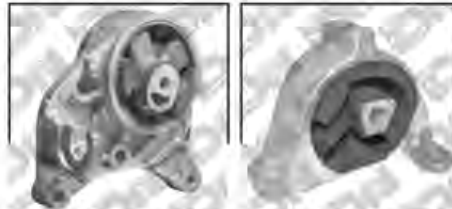
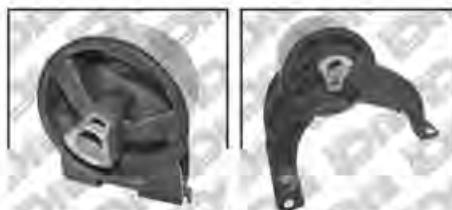
**SOPORTES
TRANSMISSION & MOTOR MOUNTS**

7054
7122

7279
7310

7337-9
7567-H
7716-9
7723-9

28	APLICACIÓN / DESCRIPTION	DAI PARTS #	DAI KIT PARTS #
-----------	---------------------------------	--------------------	------------------------

BASES PARA AMORTIGUADOR / STRUT MOUNTS

84-95	BASE PARA AMORTIGUADOR FRONTAL IZQUIERDA Y DERECHA	6636	
	BASE PARA AMORTIGUADOR FRONTAL IZQUIERDA Y DERECHA	6650	6650-KIT
	BALERO PARA BASE DE AMORTIGUADOR 6636, 6650 Y 6650-KIT	6140	

**BASES PARA AMORTIGUADOR
STRUT MOUNTS**

6140
6650

6636
6650-KIT

CONTINUACIÓN... GRAN VOYAGER

28	APLICACIÓN / DESCRIPTION	DAI PARTS #	DAI KIT PARTS #
BASES PARA AMORTIGUADOR / STRUT MOUNTS			
84-90	BASE PARA AMORTIGUADOR FRONTAL IZQUIERDA Y DERECHA	6641	6758-KIT
	BALERO PARA BASE DE AMORTIGUADOR 6641 Y 6758-KIT	6141	
96-00	BASE PARA AMORTIGUADOR FRONTAL IZQUIERDA Y DERECHA	7015	7015-KIT
01-07	BASE PARA AMORTIGUADOR FRONTAL IZQUIERDA Y DERECHA	7051	7051-KIT

BASES PARA AMORTIGUADOR STRUT MOUNTS



6141 6641



6758-KIT 7015



7015-KIT 7051 7051-KIT

28	APLICACIÓN / DESCRIPTION	DAI PARTS #
CUBRE POLVOS / C.V. BOOTS		
91-00	CUBRE POLVO IZQUIERDO Y DERECHO LADO CAJA	6391
	CUBRE POLVO IZQUIERDO Y DERECHO LADO RUEDA	6394
96-00	CUBRE POLVO IZQUIERDO Y DERECHO LADO CAJA (CON TRIPOIDE)	6310

CUBRE POLVO C.V. BOOTS

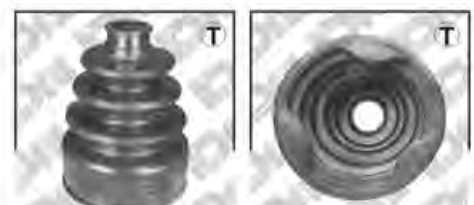

6310 6310



6391 6394



CONTINUACIÓN.. GRAN VOYAGER

	 28	APLICACIÓN / DESCRIPTION	DAI PARTS #
MISCELÁNEOS / AUTOMOTIVE RUBBER PARTS			
	84-90	GOMA PARA TIRANTE DE SUSPENSIÓN	64490
		TORNILLO ESTABILIZADOR FRONTAL	DAI-K-7258
	96-07	BUJE PARA HORQUILLA	DAI-1406012
		BUJE PARA HORQUILLA INFERIOR CHICO	DAI-4689120
	01-07	BUJE PARA HORQUILLA GRANDE	DAI-1406014



GUAYIN

MISCELÁNEOS / AUTOMOTIVE RUBBER PARTS			
	67-72	TOPE PARA AMORTIGUADOR FRONTAL IZQUIERDO Y DERECHO	D-0620



INTREPID

SOPORTES / TRANSMISSION & MOTOR MOUNTS			
V6 2.7	93-97	SOPORTE PARA TRANSMISIÓN	6695
		SOPORTE PARA TRANSMISIÓN (TIPO ORIGINAL)	6840



CONTINUACIÓN... INTREPID

 		APLICACIÓN / DESCRIPTION	DAI PARTS #
SOPORTES / TRANSMISSION & MOTOR MOUNTS			
V6 2.7	93-97	SOPORTE PARA TRANSMISIÓN	6695
		SOPORTE PARA TRANSMISIÓN (TIPO ORIGINAL)	6840
	93-97	SOPORTE PARA MOTOR IZQUIERDO Y DERECHO	6848-H
	98-04	SOPORTE PARA TRANSMISIÓN	7025
V6 3.2	98-04	SOPORTE PARA TRANSMISIÓN	7025
V6 3.3	93-99	SOPORTE PARA MOTOR IZQUIERDO Y DERECHO	6848-H
		SOPORTE PARA TRANSMISIÓN	6695
		SOPORTE PARA TRANSMISIÓN (TIPO ORIGINAL)	6840
V6 3.5	93-97	SOPORTE PARA MOTOR IZQUIERDO Y DERECHO	6848-H
		SOPORTE PARA TRANSMISIÓN	6695
		SOPORTE PARA TRANSMISIÓN (TIPO ORIGINAL)	6840
V6 3.5	98-05	SOPORTE PARA TRANSMISIÓN	7025



		APLICACIÓN / DESCRIPTION	DAI PARTS #	DAI KIT PARTS #
BASES PARA AMORTIGUADOR / STRUT MOUNTS				
93-97	BASE DE AMORTIGUADOR TRASERA IZQUIERDA Y DERECHA		6744	6744-KIT
	BASE DE AMORTIGUADOR FRONTAL IZQUIERDA Y DERECHA		6745	6745-KIT



CONTINUACIÓN.. INTREPID

28		APLICACIÓN / DESCRIPTION	DAI PARTS #	DAI KIT PARTS #
BASES PARA AMORTIGUADOR / STRUT MOUNTS				
98-05		BASE PARA AMORTIGUADOR TRASERA IZQUIERDA Y DERECHA		7230-KIT
		BASE PARA AMORTIGUADOR FRONTAL IZQUIERDA Y DERECHA		7341-KIT



28		APLICACIÓN / DESCRIPTION	DAI PARTS #
MISCELÁNEOS / AUTOMOTIVE RUBBER PARTS			
93-97		TOPE PARA AMORTIGUADOR FRONTAL IZQUIERDO Y DERECHO	D-0619
		GOMA PARA CREMALLERA DE DIRECCIÓN HID. (DERECHA PAR 713)	712
		GOMA PARA CREMALLERA DE DIRECCIÓN HID. (IZQUIERDA PAR 712)	713
		TORNILLO ESTABILIZADOR FRONTRAL	DAI-K-7197
98-05		TORNILLO ESTABILIZADOR FRONTRAL	DAI-2106008

JOURNEY

SOPORTES / TRANSMISSION & MOTOR MOUNTS			
L4 2.0 L4 2.4	07-11	REPUESTO PARA SOPORTE DE MOTOR FRONTAL Y TRASERO (BUJE INTERNO GRANDE OVALADO) (7279 Y 7310)	7279-9
		REPUESTO PARA SOPORTE DE TRANSMISIÓN (7337)	7337-9



CONTINUACIÓN... JOURNEY

  28		APLICACIÓN / DESCRIPTION	DAI PARTS #
SOPORTES / TRANSMISSION & MOTOR MOUNTS			
L4 2.4 V6 3.5	07-11	SOPORTE PARA MOTOR FRONTAL	7279
		SOPORTE PARA MOTOR TRASERO	7310
		SOPORTE PARA MOTOR FRONTAL	7321
		REPUESTO PARA SOPORTES DE MOTOR FRONTAL Y TRASERO (7321 Y 7330)	7321-9
		SOPORTE PARA MOTOR TRASERO	7330
		SOPORTE PARA TRANSMISIÓN	7337
		SOPORTE PARA MOTOR DERECHO	7345-H
V6 3.5	07-11	REPUESTO PARA SOPORTE DE TRANSMISIÓN (7337)	7337-9



 28		APLICACIÓN / DESCRIPTION	DAI PARTS #	DAI KIT PARTS #
BASES PARA AMORTIGUADOR / STRUT MOUNTS				
07-15		BASE PARA AMORTIGUADOR FRONTAL IZQUIERDA Y DERECHA	7332	7596-KIT





CONTINUACIÓN.. JOURNEY

		APLICACIÓN / DESCRIPTION	DAI PARTS #	MISCELÁNEOS AUTOMOTIVE RUBBER PARTS	
MISCELÁNEOS / AUTOMOTIVE RUBBER PARTS					
07-15	TORNILLO ESTABILIZADOR FRONTAL		DAI-K-8702		
	BUJE PARA HORQUILLA INFERIOR CHICO		DAI-1406048		
	BUJE PARA HORQUILLA INFERIOR GRANDE		DAI-1406055	64821	DAI-K-8702
	BUJE PARA EJE TRASERO		64821		



DAI-1406048

DAI-1406055
LASER

		APLICACIÓN / DESCRIPTION	DAI PARTS #	DAI KIT PARTS #	BASES PARA AMORTIGUADOR STRUT MOUNTS	
BASES PARA AMORTIGUADOR / STRUT MOUNTS						
84-86	BASE PARA AMORTIGUADOR FRONTAL IZQUIERDA Y DERECHA		6641			
	BASE PARA AMORTIGUADOR FRONTAL IZQUIERDA Y DERECHA			6758-KIT		
	BALERO PARA BASE DE AMORTIGUADOR 6641 Y 6758-KIT		6141			6141

6758-KIT

CONTINUACIÓN... LASER

 	APLICACIÓN / DESCRIPTION	DAI PARTS #
84-86	TOPE PARA AMORTIGUADOR FRONTAL IZQUIERDO Y DERECHO	D-0622

**MISCELÁNEOS
AUTOMOTIVE RUBBER PARTS**



D-0622

LEBARON

SOPORTES / TRANSMISSION & MOTOR MOUNTS			
V6 3.0 V6 3.7	89-95	SOPORTE PARA MOTOR FRONTAL	6651
		REPUESTO PARA SOPORTE DE MOTOR FRONTAL (6651)	1927
		SOPORTE PARA MOTOR DERECHO	6913
		SOPORTE PARA MOTOR DERECHO	6913-H
		REPUESTO PARA SOPORTE MOTOR DERECHO (6652)	1973
		SOPORTE PARA TRANSMISIÓN	6668
		REPUESTO PARA SOPORTE DE TRANSMISIÓN (6668)	1928

**SOPORTES
TRANSMISSION & MOTOR MOUNTS**



1927



1928



1973



6668



6651



6913



6913-H

 	APLICACIÓN / DESCRIPTION	DAI PARTS #	DAI KIT PARTS #
82-83	BASE PARA AMORTIGUADOR FRONTAL IZQUIERDA Y DERECHA	1808	1808-KIT

**BASES PARA AMORTIGUADOR
STRUT MOUNTS**



1808



1808-KIT



CONTINUACIÓN... LEBARON

28		APLICACIÓN / DESCRIPTION	DAI PARTS #	DAI KIT PARTS #
BASES PARA AMORTIGUADOR / STRUT MOUNTS				
84-88	BASE DE AMORTIGUADOR FRONTAL IZQUIERDA Y DERECHA		6758	6758-KIT
	BALERO PARA BASE DE AMORTIGUADOR 6641 Y 6758-KIT		6141	
86-95	BASE PARA AMORTIGUADOR FRONTAL IZQUIERDA Y DERECHA		6636	
	BASE PARA AMORTIGUADOR FRONTAL IZQUIERDA Y DERECHA		6650	6650-KIT
	BALERO PARA BASE DE AMORTIGUADOR 6636, 6650 Y 6650-KIT		6140	

BASES PARA AMORTIGUADOR STRUT MOUNTS

6140
6141

6636
6650

6650-KIT

6758

6758-KIT

28		APLICACIÓN / DESCRIPTION	DAI PARTS #
CUBRE POLVOS / C.V. BOOTS			
82-88	CUBRE POLVO IZQUIERDO Y DERECHO LADO RUEDA		6304
	CUBRE POLVO DERECHO LADO CAJA		6330
	CUBRE POLVO DERECHO LADO CAJA		6353
	CUBRE POLVO DERECHO LADO CAJA		6375
	CUBRE POLVO IZQUIERDO Y DERECHO DIRECCIÓN STD.		6363

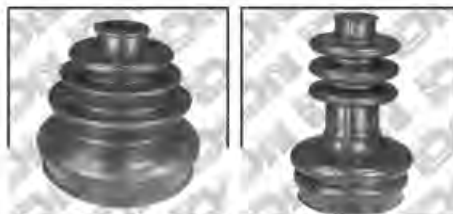

CUBRE POLVO C.V. BOOTS

6304
6330

6353

6363

6375

CONTINUACIÓN... LEBARON

 		APLICACIÓN / DESCRIPTION	DAI PARTS #
CUBRE POLVOS / C.V. BOOTS			
82-88		CUBRE POLVO IZQUIERDO Y DERECHO DIRECCIÓN HID.	6364
		CUBRE POLVO IZQUIERDO Y DERECHO LADO RUEDA	6350



MISCELÁNEOS / AUTOMOTIVE RUBBER PARTS			
62-72		TORNILLO ESTABILIZADOR (6", 177.8 mm)	6101
		TORNILLO ESTABILIZADOR (6", 177.8 mm EQUIPO ORIGINAL)	6105
62-76		TORNILLO EXCENTRICO	64600
		GOMA PARA TIRANTE DE SUSPENSIÓN	64570
73-76		TORNILLO ESTABILIZADOR (5", 1542.4 mm)	6100
		TORNILLO ESTABILIZADOR (5", 1542.4 mm EQUIPO ORIGINAL)	6104
77-82		TORNILLO ESTABILIZADOR FRONTAL IZQUIERDO Y DERECHO (CORTO)	6098
		TORNILLO ESTABILIZADOR	64590
82-88		GOMA PARA TIRANTE DE SUSPENSIÓN	64490
89-95		TOPE PARA AMORTIGUADOR FRONTAL Y TRASERO IZQUIERDO Y DERECHO	D-0621

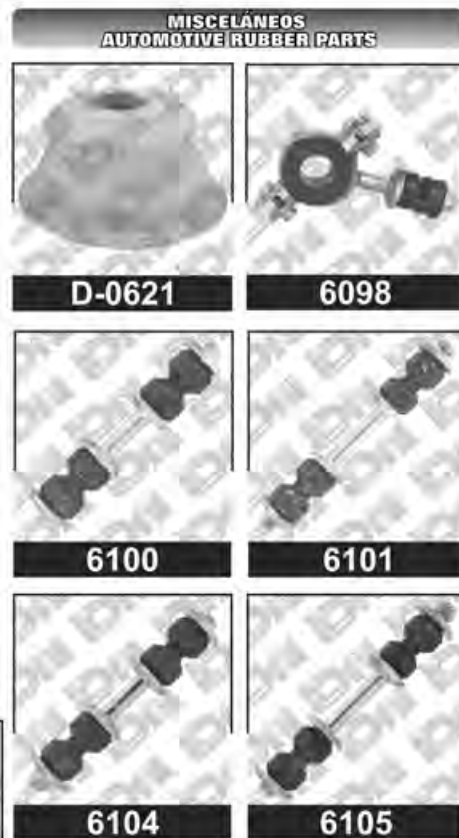

LEBARON K

		APLICACIÓN / DESCRIPTION	DAI PARTS #
SOPORTES / TRANSMISSION & MOTOR MOUNTS			
L4 2.2 L4 2.5	82-89	SOPORTE DE TORSIÓN TRASERO	1809
		SOPORTE PARA MOTOR DERECHO	1810
		SOPORTE PARA MOTOR FRONTAL	1910
		REPUESTO PARA SOPORTE DE MOTOR FRONTAL (1910)	1868
		REPUESTO PARA SOPORTE DE TRANSMISIÓN (1827)	2354



		APLICACIÓN / DESCRIPTION	DAI PARTS #	DAI KIT PARTS #
BASES PARA AMORTIGUADOR / STRUT MOUNTS				
84-85		BASE PARA AMORTIGUADOR FRONTAL IZQUIERDA Y DERECHA	1820	1820-KIT
84-88		BASE PARA AMORTIGUADOR FRONTAL IZQUIERDA Y DERECHA	6641	
		BASE PARA AMORTIGUADOR FRONTAL IZQUIERDA Y DERECHA		6758-KIT
		BALERO PARA BASE DE AMORTIGUADOR 6641 Y 6758-KIT	6141	



CONTINUACIÓN... LEBARON K

 		APLICACIÓN / DESCRIPTION	DAI PARTS #
MISCELÁNEOS / AUTOMOTIVE RUBBER PARTS			
82-89		TOPE PARA AMORTIGUADOR FRONTAL IZQUIERDO Y DERECHO	D-0619
		TOPE PARA AMORTIGUADOR FRONTAL IZQUIERDO Y DERECHO	D-0622
		GOMA SUJETADORA DE ESCAPE (TIRANTE)	6548
		GOMA SUJETADORA DE ESCAPE	6549



LERMA

MISCELÁNEOS / AUTOMOTIVE RUBBER PARTS			
62-72		TORNILLO ESTABILIZADOR (6", 177.8 mm)	6101
		TORNILLO ESTABILIZADOR (6", 177.8 mm EQUIPO ORIGINAL)	6105



LHS

SOPORTES / TRANSMISSION & MOTOR MOUNTS			
V6 3.5	95-98	SOPORTE PARA TRANSMISIÓN	6695
		SOPORTE PARA TRANSMISIÓN (TIPO ORIGINAL)	6840





CONTINUACIÓN... LHS

 		APLICACIÓN / DESCRIPTION	DAI PARTS #
SOPORTES / TRANSMISSION & MOTOR MOUNTS			
V6 3.5	95-98	SOPORTE PARA MOTOR IZQUIERDO Y DERECHO	6848-H
	99-01	SOPORTE PARA TRANSMISIÓN	7025



		APLICACIÓN / DESCRIPTION	DAI PARTS #	DAI KIT PARTS #
BASES PARA AMORTIGUADOR / STRUT MOUNTS				
93-97		BASE PARA AMORTIGUADOR TRASERA IZQUIERDA Y DERECHA	6744	6744-KIT
		BASE PARA AMORTIGUADOR FRONTAL IZQUIERDA Y DERECHA	6745	6745-KIT
98-05		BASE PARA AMORTIGUADOR TRASERA IZQUIERDA Y DERECHA		7230-KIT
		BASE PARA AMORTIGUADOR FRONTAL IZQUIERDA Y DERECHA		7341-KIT



 		APLICACIÓN / DESCRIPTION	DAI PARTS #
MISCELÁNEOS / AUTOMOTIVE RUBBER PARTS			
	98-05	TOPE PARA AMORTIGUADOR FRONTAL IZQUIERDO Y DERECHO	D-0619
		TORNILLO ESTABILIZADOR FRONTAL	DAI-2106008



CONTINUACIÓN... LHS

	 28	APLICACIÓN / DESCRIPTION	DAI PARTS #
MISCELÁNEOS / AUTOMOTIVE RUBBER PARTS			
	93-97	TORNILLO ESTABILIZADOR FRONTAL	DAI-K-7197

**MISCELÁNEOS
AUTOMOTIVE RUBBER PARTS**



DAI-2106008

MAGNUM

SOPORTES / TRANSMISSION & MOTOR MOUNTS			
V6 3.5	05-07	SOPORTE PARA MOTOR IZQUIERDO Y DERECHO	7442-H
V8 5.2 V8 5.9	74-82	SOPORTE PARA MOTOR DERECHO	1765
		SOPORTE PARA MOTOR IZQUIERDO	1766
		SOPORTE PARA TRANSMISIÓN STD. Y AUT.	1775
		REPUESTO PARA SOPORTE MOTOR IZQUIERDO (1766) Y DERECHO (1765)	2352
			REPUESTO PARA SOPORTE DE TRANSMISIÓN STD. Y AUT. (1762 Y 1775)
	75-82	SOPORTE PARA TRANSMISIÓN AUT.	1762
V8 5.7 V8 6.1	05-11	SOPORTE PARA MOTOR IZQUIERDO Y DERECHO	7698-H

**SOPORTES
TRANSMISSION & MOTOR MOUNTS**



1762



1765



1775



2349



2352



7442-H



7698-H



CONTINUACIÓN... MAGNUM

28	APLICACIÓN / DESCRIPTION	DAI PARTS #	DAI KIT PARTS #
BASES PARA AMORTIGUADOR / STRUT MOUNTS			
75-82	BASE PARA AMORTIGUADOR FRONTAL IZQUIERDA Y DERECHA	1820	1820-KIT
	BASE PARA AMORTIGUADOR FRONTAL IZQUIERDA Y DERECHA	6641	
	BASE PARA AMORTIGUADOR FRONTAL IZQUIERDA Y DERECHA		6758-KIT
	BALERO PARA BASES DE AMORTIGUADOR 6641 Y 6758-KIT	6141	
06-11	BASE PARA AMORTIGUADOR FRONTAL IZQUIERDA		7593-KIT
	BASE PARA AMORTIGUADOR FRONTAL DERECHA		7594-KIT

**BASES PARA AMORTIGUADOR
STRUT MOUNTS**

1820

1820-KIT

6141

6641

6758-KIT

7594-KIT

7593-KIT

28	APLICACIÓN / DESCRIPTION	DAI PARTS #
MISCELÁNEOS / AUTOMOTIVE RUBBER PARTS		
62-72	TORNILLO ESTABILIZADOR (6", 177.8 mm)	6101
	TORNILLO ESTABILIZADOR (6", 177.8 mm EQUIPO ORIGINAL)	6105
62-76	GOMA PARA TIRANTE DE SUSPENSIÓN	64570
	TORNILLO EXCÉNTRICO	64600

**MISCELÁNEOS
AUTOMOTIVE RUBBER PARTS**

6101

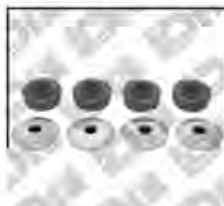
6105

64570

64600



CONTINUACIÓN... MAGNUM

  28		APLICACIÓN / DESCRIPTION	DAI PARTS #
MISCELÁNEOS / AUTOMOTIVE RUBBER PARTS			
73-76		TORNILLO ESTABILIZADOR (5", 1542.4 mm)	6100
		TORNILLO ESTABILIZADOR (5", 1542.4 mm EQUIPO ORIGINAL)	6104
77-82		TORNILLO ESTABILIZADOR	64590
		TORNILLO ESTABILIZADOR FRONTAL IZQUIERDO Y DERECHO (CORTO)	6098
82-88		GOMA PARA TIRANTE DE SUSPENSIÓN	64490
07-11		BUJE PARA HORQUILLA INFERIOR	DAI-1406091

**MISCELÁNEOS
AUTOMOTIVE RUBBER PARTS**



6098



6100



6104



64490



64590



DAI-1406091

MAGNUM K

SOPORTES / TRANSMISSION & MOTOR MOUNTS			
L4 2.2 L4 2.5	82-89	SOPORTE DE TORSIÓN TRASERO	1809
		SOPORTE PARA MOTOR DERECHO	1810
		REPUESTO PARA SOPORTE DE MOTOR FRONTAL (1910)	1868
		SOPORTE PARA MOTOR FRONTAL	1910
		REPUESTO PARA SOPORTE DE TRANSMISIÓN (1827)	2354

**SOPORTES
TRANSMISSION & MOTOR MOUNTS**



1809



1810



1868



1910



2354



CONTINUACIÓN... MAGNUM K

		APLICACIÓN / DESCRIPTION	DAI PARTS #
MISCELÁNEOS / AUTOMOTIVE RUBBER PARTS			
82-89	TOPE PARA AMORTIGUADOR FRONTAL IZQUIERDO Y DERECHO		D-0622
	GOMA SUJETADORA DE ESCAPE (TIRANTE)		6548
	GOMA SUJETADORA DE ESCAPE		6549

MONACO

SOPORTES / TRANSMISSION & MOTOR MOUNTS			
V8 5.2 V8 5.9	65-72	SOPORTE PARA TRANSMISIÓN STD. Y AUT.	1648
	72-82	SOPORTE PARA MOTOR DERECHO	1765
		REPUESTO SOPORTE IZQUIERDO (1766) Y DERECHO (1765)	2352
		REPUESTO PARA SOPORTE DE TRANSMISIÓN STD. Y AUT. (1762 Y 1775)	2349
		SOPORTE PARA TRANSMISIÓN STD.	1775



CONTINUACIÓN... MONACO

	 28	APLICACIÓN / DESCRIPTION	DAI PARTS #
MISCELÁNEOS / AUTOMOTIVE RUBBER PARTS			
	65-73	TORNILLO EXCENTRICO	64600



NEON

SOPORTES / TRANSMISSION & MOTOR MOUNTS			
L4 2.0	95-99	SOPORTE PARA MOTOR DERECHO	6669
		REPUESTO PARA SOPORTE MOTOR DERECHO (6669)	6669-9
		SOPORTE PARA MOTOR FRONTAL	6682
		SOPORTE PARA TRANSMISIÓN AUT.	6670
		SOPORTE PARA TRANSMISIÓN STD.	6671
		REPUESTO PARA SOPORTE DE MOTOR FRONTAL (6682)	6683
		REPUESTO PARA SOPORTE DE TRANSMISIÓN STD. Y AUT. (6670 Y 6671)	6763
L4 2.0 L4 2.4	00-05	SOPORTE PARA MOTOR DERECHO INFERIOR	6902
		REPUESTO PARA SOPORTE DE MOTOR DERECHO INFERIOR (6902)	6902-9
		SOPORTE DE TORSIÓN DERECHO SUPERIOR	6903
		REPUESTO PARA SOPORTE DE MOTOR DERECHO SUPERIOR (6903)	6903-9
		SOPORTE PARA MOTOR DERECHO	6943



CONTINUACIÓN... NEON

		APLICACIÓN / DESCRIPTION	DAI PARTS #
SOPORTES / TRANSMISSION & MOTOR MOUNTS			
L4 2.0 L4 2.4	00-05	SOPORTE PARA TRANSMISIÓN AUT., 3 VEL.	6944
		SOPORTE PARA TRANSMISIÓN STD.	7187
		SOPORTE PARA TRANSMISIÓN AUT. 4 VEL. O/D	7361



		APLICACIÓN / DESCRIPTION	DAI PARTS #	DAI KIT PARTS #
BASES PARA AMORTIGUADOR / STRUT MOUNTS				
95-99		BASE PARA AMORTIGUADOR FRONTAL IZQUIERDA Y DERECHA	6748	6748-KIT
		BASE PARA AMORTIGUADOR TRASERA IZQUIERDA Y DERECHA	6749	6749-KIT
00-05		BASE PARA AMORTIGUADOR TRASERA IZQUIERDA Y DERECHA		7293-KIT
		BASE PARA AMORTIGUADOR FRONTAL IZQUIERDA Y DERECHA		7381-KIT



CONTINUACIÓN... NEON

		APLICACIÓN / DESCRIPTION	DAI PARTS #
CUBRE POLVOS / C.V. BOOTS			
95-99		CUBRE POLVO IZQUIERDO Y DERECHO LADO RUEDA	6385
		CUBRE POLVO DERECHO LADO CAJA (CON TRIPOIDE)	6386
		CUBRE POLVO IZQUIERDO LADO CAJA	6397
00-05		CUBRE POLVO IZQUIERDO Y DERECHO LADO RUEDA	6316
		CUBRE POLVO IZQUIERDO Y DERECHO LADO CAJA	6318



MISCELÁNEOS / AUTOMOTIVE RUBBER PARTS

95-99		GOMA SUJETADORA DE ESCAPE	6564
		GOMA SUJETADORA DE ESCAPE	6565
		TOPE PARA AMORTIGUADOR FRONTAL Y TRASERO IZQUIERDO Y DERECHO	D-0621
95-05		TOPE PARA AMORTIGUADOR FRONTAL IZQUIERDO Y DERECHO	D-0619
		TOPE PARA AMORTIGUADOR TRASERO IZQUIERDO Y DERECHO	D-0620



CONTINUACIÓN.. NEON

 28	APLICACIÓN / DESCRIPTION	DAI PARTS #
---	--------------------------	-------------

MISCELÁNEOS / AUTOMOTIVE RUBBER PARTS

00-05	BUJE PARA HORQUILLA INFERIOR CHICO	DAI-5272252
	TORNILLO ESTABILIZADOR FRONTAL	DAI-2106006
	BUJE PARA HORQUILLA INFERIOR GRANDE	DAI-5272250

DAI-5272252
**MISCELÁNEOS
AUTOMOTIVE RUBBER PARTS**

DAI-2106006

DAI-5272250
NEW YORKER
SOPORTES / TRANSMISSION & MOTOR MOUNTS

L4 2.2 L4 2.5	90-93	SOPORTE DE TORSIÓN TRASERO	1809
		SOPORTE PARA MOTOR DERECHO	1810
		SOPORTE PARA MOTOR FRONTAL	1910
		REPUESTO PARA SOPORTE DE MOTOR FRONTAL (1910)	1868
		REPUESTO PARA SOPORTE DE TRANSMISIÓN (6700)	2354

V6 3.0	88-90	SOPORTE PARA MOTOR DERECHO	1810
		REPUESTO PARA SOPORTE DE TRANSMISIÓN (1827)	2354
		SOPORTE PARA MOTOR FRONTAL	6651
		REPUESTO PARA SOPORTE DE MOTOR FRONTAL (6651)	1927

**SOPORTES
TRANSMISSION & MOTOR MOUNTS**

1809

1810

1868

1910

1927

2354

6651

CONTINUACIÓN... NEW YORKER

 		APLICACIÓN / DESCRIPTION	DAI PARTS #
SOPORTES / TRANSMISSION & MOTOR MOUNTS			
V6 3.3	90-95	SOPORTE PARA MOTOR FRONTAL	6651
		REPUESTO PARA SOPORTE DE MOTOR FRONTAL (6651)	1927
		SOPORTE PARA TRANSMISIÓN (16 VALVULAS)	6700
		REPUESTO PARA SOPORTE DE TRANSMISIÓN (6700)	2354
		SOPORTE PARA MOTOR DERECHO	6913
		SOPORTE PARA MOTOR DERECHO	6913-H
V6 3.5	90-95	SOPORTE PARA TRANSMISIÓN	6700
		REPUESTO PARA SOPORTE DE TRANSMISIÓN (6700)	2354
		SOPORTE PARA MOTOR FRONTAL	6651
	95-97	REPUESTO PARA SOPORTE DE MOTOR FRONTAL (6651)	1927
		SOPORTE PARA MOTOR IZQUIERDO Y DERECHO	6848-H
		SOPORTE PARA TRANSMISIÓN	6695
		SOPORTE PARA TRANSMISIÓN (TIPO ORIGINAL)	6840

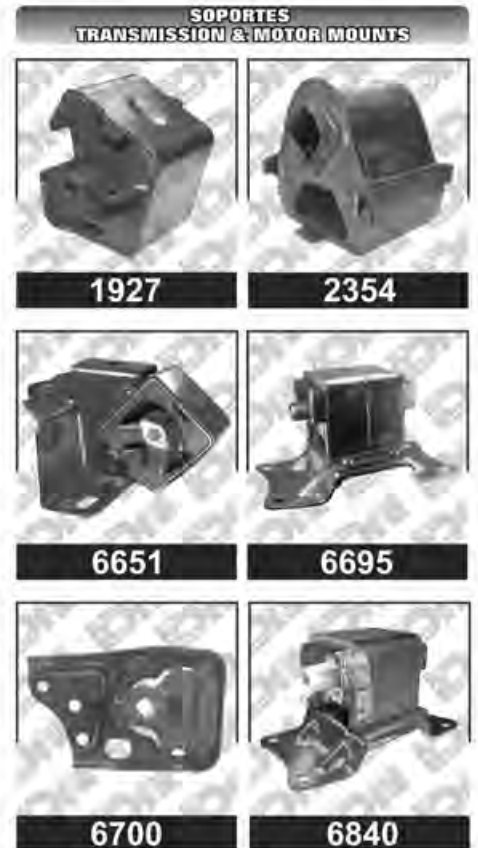

		APLICACIÓN / DESCRIPTION	DAI PARTS #	DAI KIT PARTS #
BASES PARA AMORTIGUADOR / STRUT MOUNTS				
82-83		BASE PARA AMORTIGUADOR FRONTAL IZQUIERDA Y DERECHA	1808	1808-KIT



CONTINUACIÓN.. NEW YORKER

28	APLICACIÓN / DESCRIPTION	DAI PARTS #	DAI KIT PARTS #	BASES PARA AMORTIGUADOR STRUT MOUNTS	
BASES PARA AMORTIGUADOR / STRUT MOUNTS					
84-85	BASE PARA AMORTIGUADOR FRONTAL IZQUIERDA Y DERECHA	1820	1820-KIT		
				1820	1820-KIT
86-95	BASE PARA AMORTIGUADOR FRONTAL IZQUIERDA Y DERECHA	6636			
	BASE PARA AMORTIGUADOR FRONTAL IZQUIERDA Y DERECHA	6650	6650-KIT		
				6140	6141
	BALERO PARA BASE DE AMORTIGUADOR 6636, 6650 Y 6650-KIT	6140			
84-88	BASE PARA AMORTIGUADOR FRONTAL IZQUIERDA Y DERECHA	6641			
	BASE PARA AMORTIGUADOR FRONTAL IZQUIERDA Y DERECHA		6758-KIT		
				6636	6641
93-97	BASE DE AMORTIGUADOR TRASERA IZQUIERDA Y DERECHA	6744	6744-KIT		
	BASE DE AMORTIGUADOR FRONTAL IZQUIERDA Y DERECHA	6745	6745-KIT		
				6650	6650-KIT
				6744	6744-KIT
				6745	6745-KIT
				6758	6758-KIT



CONTINUACIÓN... NEW YORKER



		APLICACIÓN / DESCRIPTION	DAI PARTS #
CUBRE POLVOS / C.V. BOOTS			
82-88		CUBRE POLVO IZQUIERDO Y DERECHO DIRECCIÓN STD.	6363
		CUBRE POLVO IZQUIERDO Y DERECHO DIRECCIÓN HID.	6364
		CUBRE POLVO IZQUIERDO Y DERECHO LADO RUEDA	6350
82-97		CUBRE POLVO DERECHO LADO CAJA	6330
		CUBRE POLVO DERECHO LADO CAJA	6353
		CUBRE POLVO IZQUIERDO LADO CAJA	6375
		CUBRE POLVO IZQUIERDO Y DERECHO LADO RUEDA	6304
		CUBRE POLVO IZQUIERDO Y DERECHO LADO RUEDA	6306
		CUBRE POLVO IZQUIERDO Y DERECHO LADO RUEDA	6380
		CUBRE POLVO IZQUIERDO Y DERECHO LADO RUEDA (FLECHA IMPORTADA)	6396
		CUBRE POLVO IZQUIERDO Y DERECHO DE DIRECCIÓN HID.	6381



MISCELÁNEOS / AUTOMOTIVE RUBBER PARTS			
82-88		TOPE PARA AMORTIGUADOR FRONTAL IZQUIERDO Y DERECHO	D-0622
		GOMA PARA TIRANTE DE SUSPENSIÓN	64490





CONTINUACIÓN... NEW YORKER

	 28	APLICACIÓN / DESCRIPTION	DAI PARTS #
MISCELÁNEOS / AUTOMOTIVE RUBBER PARTS			
	93-97	TORNILLO ESTABILIZADOR FRONTAL	DAI-K-7197
	94-97	TOPE PARA AMORTIGUADOR FRONTAL IZQUIERDO Y DERECHO	D-0619
	98-04	TORNILLO ESTABILIZADOR FRONTAL	DAI-2106008

NITRO

 28	APLICACIÓN / DESCRIPTION	DAI PARTS #	DAI KIT PARTS #
BASES PARA AMORTIGUADOR / STRUT MOUNTS			
08-12	BASE PARA AMORTIGUADOR FRONTAL IZQUIERDA		7370-KIT
	BASE PARA AMORTIGUADOR FRONTAL DERECHA		7371-KIT



	 28	APLICACIÓN / DESCRIPTION	DAI PARTS #
MISCELÁNEOS / AUTOMOTIVE RUBBER PARTS			
	06-12	BUJE PARA HORQUILLA INFERIOR TRASERO	DAI-1406068



PACIFICA

		APLICACIÓN / DESCRIPTION	DAI PARTS #
SOportes / TRANSMISSION & MOTOR MOUNTS			
V6 3.5 V6 3.8	04-06	SOPOrTE PARA MOTOR FRONTAL	7277-H
		SOPOrTE PARA TRANSMISIÓN	7363
V6 3.8	08-09	SOPOrTE PARA MOTOR FRONTAL	7509-H
V6 4.0	07-08	SOPOrTE PARA TRANSMISIÓN	7363
	08-09	SOPOrTE PARA MOTOR FRONTAL	7509-H





	APLICACIÓN / DESCRIPTION	DAI PARTS #	DAI KIT PARTS #
BASES PARA AMORTIGUADOR / STRUT MOUNTS			
04-07	BASE PARA AMORTIGUADOR FRONTAL IZQUIERDA Y DERECHA	7051	7051-KIT



	APLICACIÓN / DESCRIPTION	DAI PARTS #
MISCELÁNEOS / AUTOMOTIVE RUBBER PARTS		
04-07	TORNILLO ESTABILIZADOR FRONTAL	DAI-2106017
	BUJE PARA HORQUILLA INFERIOR CHICO	DAI-4689120



PHANTOM

 		APLICACIÓN / DESCRIPTION	DAI PARTS #
SOPORTES / TRANSMISSION & MOTOR MOUNTS			
L4 2.2 L4 2.5	87-89	SOPORTE DE TORSIÓN TRASERO	1809
		SOPORTE PARA TRANSMISIÓN	6700
	87-95	SOPORTE PARA MOTOR FRONTAL	1910
	88-95	SOPORTE PARA ALTERNADOR	6830
	90-95	SOPORTE PARA TRANSMISIÓN	6668
		REPUESTO PARA SOPORTE DE TRANSMISIÓN (6668)	1928
	91-95	SOPORTE PARA MOTOR FRONTAL	6651
		REPUESTO PARA SOPORTE DE MOTOR FRONTAL (6651)	1927
SOPORTE PARA MOTOR DERECHO		6652	
		REPUESTO PARA SOPORTE MOTOR DERECHO (6652)	1973
V6 3.0	92-94	SOPORTE PARA MOTOR FRONTAL	6651
		REPUESTO PARA SOPORTE DE MOTOR FRONTAL (6651)	1927
		REPUESTO PARA SOPORTE DE TRANSMISIÓN (6668)	1928
		SOPORTE PARA TRANSMISIÓN	6668

**SOPORTES
TRANSMISSION & MOTOR MOUNTS**

1809

1910

1927

1928

1973

6651

6652
6668
6700
6830

		APLICACIÓN / DESCRIPTION	DAI PARTS #	DAI KIT PARTS #
BASES PARA AMORTIGUADOR / STRUT MOUNTS				
89-95		BASE PARA AMORTIGUADOR FRONTAL IZQUIERDA Y DERECHA	6636	

**BASES PARA AMORTIGUADOR
STRUT MOUNTS**

6636

CONTINUACIÓN... PHANTOM

28	APLICACIÓN / DESCRIPTION	DAI PARTS #	DAI KIT PARTS #
BASES PARA AMORTIGUADOR / STRUT MOUNTS			
89-95	BASE PARA AMORTIGUADOR FRONTAL IZQUIERDA Y DERECHA	6650	6650-KIT
	BALERO PARA BASE DE AMORTIGUADOR 6636, 6650 Y 6650-KIT	6140	



28	APLICACIÓN / DESCRIPTION	DAI PARTS #
CUBRE POLVOS / C.V. BOOTS		
88-95	CUBRE POLVO IZQUIERDO Y DERECHO LADO RUEDA	6304
	CUBRE POLVO DERECHO LADO CAJA	6330
	CUBRE POLVO DERECHO LADO CAJA	6353
	CUBRE POLVO IZQUIERDO Y DERECHO DIRECCIÓN STD.	6363
	CUBRE POLVO DERECHO LADO CAJA	6375
	CUBRE POLVO IZQUIERDO Y DERECHO DIRECCIÓN HID.	6364
	CUBRE POLVO IZQUIERDO Y DERECHO LADO RUEDA	6350
	CUBRE POLVO IZQUIERDO Y DERECHO LADO RUEDA	6306



CONTINUACIÓN... PHANTOM

 28		APLICACIÓN / DESCRIPTION	DAI PARTS #
CUBRE POLVOS / C.V. BOOTS			
88-95		CUBRE POLVO IZQUIERDO Y DERECHO LADO RUEDA	6380
		CUBRE POLVO IZQUIERDO Y DERECHO LADO RUEDA (FLECHA IMPORTADA)	6396
		CUBRE POLVO IZQUIERDO Y DERECHO DE DIRECCIÓN HID.	6381



MISCELÁNEOS / AUTOMOTIVE RUBBER PARTS			
88-95		TOPE PARA AMORTIGUADOR FRONTAL IZQUIERDO Y DERECHO	D-0622
		GOMA SUJETADORA DE ESCAPE	6546

PICK UP

SOPORTES / TRANSMISSION & MOTOR MOUNTS			
V6 3.3 V8 5.9	91-94	SOPORTE PARA MOTOR IZQUIERDO Y DERECHO	1892
		SOPORTE PARA MOTOR IZQUIERDO Y DERECHO	1891



CONTINUACIÓN... PICK UP

 		APLICACIÓN / DESCRIPTION	DAI PARTS #
SOPORTES / TRANSMISSION & MOTOR MOUNTS			
V6 3.3 V8 5.9	91-9	SOPORTE PARA TRANSMISIÓN STD.	1894
		SOPORTE PARA TRANSMISIÓN AUT.	1895



MISCELÁNEOS / AUTOMOTIVE RUBBER PARTS			
	79-85	GOMAS PARA TIRANTE DE SUSPENSIÓN	6056



PLYMOUTH

SOPORTES / TRANSMISSION & MOTOR MOUNTS			
L6 2.8 L6 3.7	64-67	SOPORTE PARA MOTOR DERECHO	1659
		SOPORTE PARA TRANSMISIÓN STD. Y AUT.	1648
		SOPORTE PARA MOTOR IZQUIERDO	1656
	67-72	SOPORTE PARA MOTOR IZQUIERDO	1649
		SOPORTE PARA MOTOR DERECHO	1658
V8 318 V8 360	67-71	SOPORTE PARA MOTOR DERECHO	1672
		SOPORTE PARA MOTOR IZQUIERDO	1673
		SOPORTE PARA TRANSMISIÓN STD. Y AUT.	1648



CONTINUACIÓN... PLYMOUTH

 28	APLICACIÓN / DESCRIPTION	DAI PARTS #
MISCELÁNEOS / AUTOMOTIVE RUBBER PARTS		
59-64	TORNILLO EXCENTRICO	64600

PT CRUISER

SOPORTES / TRANSMISSION & MOTOR MOUNTS			
L4 2.4	01-10	SOPORTE DE TORSIÓN DERECHO INFERIOR	6902
		REPUESTO PARA SOPORTE DE MOTOR DERECHO INFERIOR (6902)	6902-9
		SOPORTE DE TORSIÓN DERECHO SUPERIOR	6903
		REPUESTO PARA SOPORTE DE MOTOR DERECHO SUPERIOR (6903)	6903-9
		SOPORTE PARA MOTOR DERECHO	6943



 28	APLICACIÓN / DESCRIPTION	DAI PARTS #	DAI KIT PARTS #
BASES PARA AMORTIGUADOR / STRUT MOUNTS			
01-10	BASE PARA AMORTIGUADOR FRONTAL IZQUIERDA Y DERECHA		7381-KIT



CONTINUACIÓN... PT CRUISER

	 28	APLICACIÓN / DESCRIPTION	DAI PARTS #
CUBRE POLVOS / C.V. BOOTS			
	01-10	CUBRE POLVO IZQUIERDO Y DERECHO LADO RUEDA	6316
		CUBRE POLVO IZQUIERDO Y DERECHO LADO CAJA	6318
	03-07	CUBRE POLVO IZQUIERDO Y DERECHO LADO RUEDA (TURBO)	6333
		CUBRE POLVO IZQUIERDO Y DERECHO LADO CAJA (TURBO)	6334



MISCELÁNEOS / AUTOMOTIVE RUBBER PARTS			
	01-10	TOPE PARA AMORTIGUADOR FRONTAL IZQUIERDO Y DERECHO	D-0619
		BUJE PARA HORQUILLA INFERIOR CHICO	DAI-5272252
		TORNILLO ESTABILIZADOR FRONTAL	DAI-2106006
		BUJE PARA HORQUILLA INFERIOR GRANDE	DAI-5272250



RALLY

28		APLICACIÓN / DESCRIPTION	DAI PARTS #
MISCELÁNEOS / AUTOMOTIVE RUBBER PARTS			
62-72	TORNILLO ESTABILIZADOR (6", 177.8 mm)	6101	
	TORNILLO ESTABILIZADOR (6", 177.8 mm EQUIPO ORIGINAL)	6105	

RAM







MISCELÁNEOS / AUTOMOTIVE RUBBER PARTS			
1996	GOMA PARA BARRA ESTABILIZADORA	6407	



RAM 50

MISCELÁNEOS / AUTOMOTIVE RUBBER PARTS			
82-85	TORNILLO ESTABILIZADOR (5", 1542.4 mm (4X4))	6100	
	TORNILLO ESTABILIZADOR (5", 1542.4 mm EQUIPO ORIGINAL)	6104	

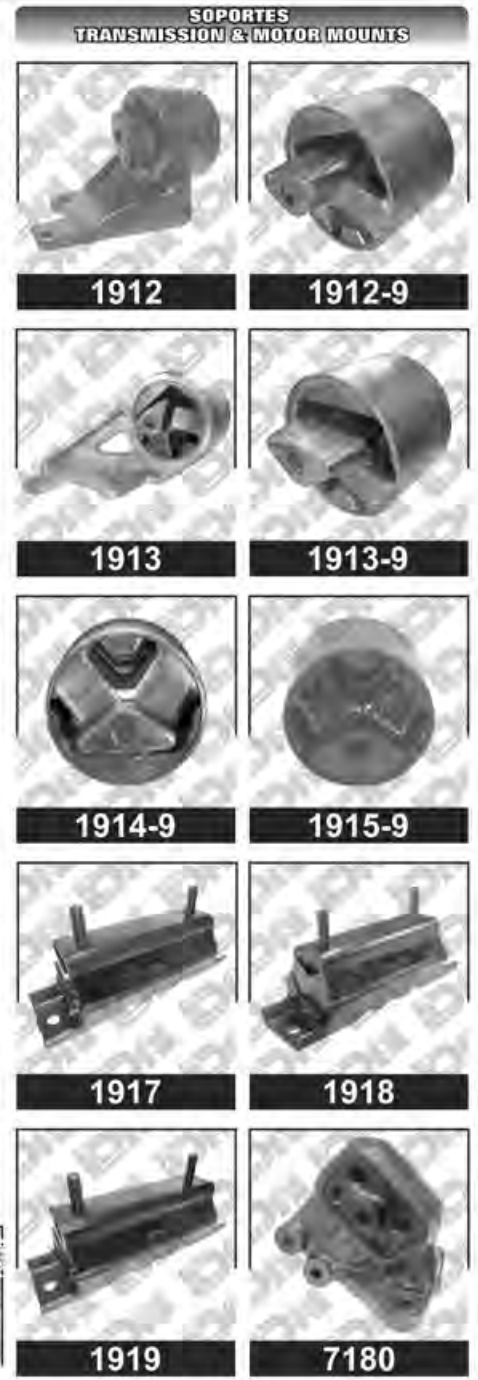

RAM 1500

		28	APLICACIÓN / DESCRIPTION	DAI PARTS #	
SOPORTES / TRANSMISSION & MOTOR MOUNTS					
V6 3.7	06-07		SOPORTE PARA TRANSMISIÓN (4X4)	7584	
V8 4.7					
V8 3.9 V8 5.2	94-00		SOPORTE PARA MOTOR DERECHO	1912	
			REPUESTO PARA SOPORTE DE MOTOR DERECHO (1912)	1912-9	
			SOPORTE PARA MOTOR IZQUIERDO	1913	
			REPUESTO PARA SOPORTE DE MOTOR IZQUIERDO (1913)	1913-9	
			REPUESTO SOPORTE PARA MOTOR DERECHO	1914-9	
			REPUESTO SOPORTE PARA MOTOR IZQUIERDO	1915-9	
			SOPORTE PARA TRANSMISIÓN	1917	
			SOPORTE PARA TRANSMISIÓN	1918	
			SOPORTE PARA TRANSMISIÓN (REFORZADO)	1919	
V8 3.8	02-05		SOPORTE PARA TRANSMISIÓN STD.	7463	
V8 4.7	06-08				
V8 4.7	01-05		SOPORTE PARA MOTOR DERECHO	7181	
V8 5.7			SOPORTE PARA MOTOR IZQUIERDO	7180	
V8 5.9	94-00		SOPORTE PARA MOTOR DERECHO	1912	
			REPUESTO PARA SOPORTE DE MOTOR DERECHO (1912)	1912-9	
			SOPORTE PARA MOTOR IZQUIERDO	1913	
					
7180-9	7181	7463	7584		



CONTINUACIÓN... RAM 1500

 		APLICACIÓN / DESCRIPTION	DAI PARTS #
SOPORTES / TRANSMISSION & MOTOR MOUNTS			
V8 5.9	94-00	REPUESTO PARA SOPORTE DE MOTOR IZQUIERDO (1913)	1913-9
		REPUESTO PARA SOPORTE MOTOR DERECHO	1914-9
		REPUESTO PARA SOPORTE MOTOR IZQUIERDO	1915-9
		SOPORTE PARA TRANSMISIÓN	1917
		SOPORTE PARA TRANSMISIÓN	1918
		SOPORTE PARA TRANSMISIÓN (REFORZADO)	1919
01-05		SOPORTE PARA MOTOR IZQUIERDO	7180
		SOPORTE PARA MOTOR DERECHO	7181
		REPUESTO PARA SOPORTE DE MOTOR IZQUIERDO Y DERECHO (7180 Y 7181)	7180-9
03-08		SOPORTE PARA MOTOR IZQUIERDO Y DERECHO	7545

**SOPORTES
TRANSMISSION & MOTOR MOUNTS**

1913-9

1914-9

1915-9

1917

1918

1919

7180
7180-9
7181
7545
MISCELÁNEOS / AUTOMOTIVE RUBBER PARTS

70-78	TORNILLO EXCENTRICO VAM Y WAGON	64600
94-02	GOMA PARA BARRA ESTABILIZADORA (4X2)	64692

**MISCELÁNEOS
AUTOMOTIVE RUBBER PARTS**

64600

64692



CONTINUACIÓN... RAM 1500

  28		APLICACIÓN / DESCRIPTION	DAI PARTS #
MISCELÁNEOS / AUTOMOTIVE RUBBER PARTS			
	98-05	GOMA PARA BARRA ESTABILIZADORA 11/8"	64693
	00-05	GOMA PARA BARRA ESTABILIZADORA 1"	64704
	06-14	BUJE PARA HORQUILLA SUPERIOR (4X2 Y 4X4) SUSPENSIÓN INDEPENDIENTE	DAI-1406036
	07-12	BUJE PARA HORQUILLA SUPERIOR (4X4) SUSPENSIÓN INDEPENDIENTE	DAI-1406036

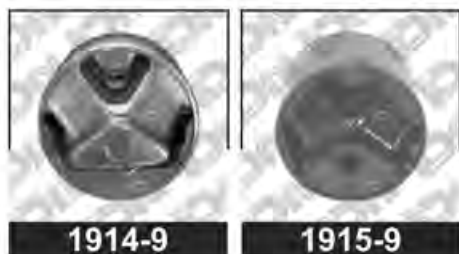

RAM 2500

SOPORTES / TRANSMISSION & MOTOR MOUNTS			
V8 3.9 V8 5.2 V8 5.9	94-00	SOPORTE PARA MOTOR DERECHO	1912
		REPUESTO PARA SOPORTE DE MOTOR DERECHO (1912)	1912-9
		SOPORTE PARA MOTOR IZQUIERDO	1913
		REPUESTO PARA SOPORTE DE MOTOR IZQUIERDO (1913)	1913-9
		REPUESTO SOPORTE PARA MOTOR DERECHO	1914-9
		REPUESTO SOPORTE PARA MOTOR IZQUIERDO	1915-9



CONTINUACIÓN... RAM 2500



 		APLICACIÓN / DESCRIPTION	DAI PARTS #
SOPORTES / TRANSMISSION & MOTOR MOUNTS			
V8 3.9	94-00	SOPORTE PARA TRANSMISIÓN	1917
V8 5.2		SOPORTE PARA TRANSMISIÓN	1918
V8 5.9		SOPORTE PARA TRANSMISIÓN (REFORZADO)	1919
V8 4.7	01-05	SOPORTE PARA MOTOR DERECHO	7181
V8 5.7		SOPORTE PARA MOTOR IZQUIERDO	7180
V8 5.9		REPUESTO PARA SOPORTE DE MOTOR IZQUIERDO Y DERECHO (7180 Y 7181)	7180-9
V8 5.7 V8 5.9 V8 6.7	06-08	SOPORTE PARA TRANSMISIÓN (4X4)	7584
V8 5.9	02-05	SOPORTE PARA TRANSMISIÓN STD.	7463
	03-08	SOPORTE PARA MOTOR IZQUIERDO Y DERECHO	7545

MISCELÁNEOS / AUTOMOTIVE RUBBER PARTS

70-78	TORNILLO EXCENTRICO VAM Y WAGON	64600
94-02	GOMA PARA BARRA ESTABILIZADORA SUSPENSIÓN INDEPENDIENTE (4X2)	64692



CONTINUACIÓN... RAM 2500

  28		APLICACIÓN / DESCRIPTION	DAI PARTS #
MISCELÁNEOS / AUTOMOTIVE RUBBER PARTS			
	94-05	GOMA SUJETADORA DE ESCAPE	6566
	98-05	GOMA PARA BARRA ESTABILIZADORA 11/8"	64693
	00-05	GOMA PARA BARRA ESTABILIZADORA 1"	64704

**MISCELÁNEOS
AUTOMOTIVE RUBBER PARTS**



6566



64693



64704

RAM 3500

SOPORTES / TRANSMISSION & MOTOR MOUNTS			
L6 5.7	08-13	SOPORTE PARA TRANSMISIÓN (GAS)	7577
L6 6.7		SOPORTE PARA TRANSMISIÓN (DIESEL)	
V8 5.9	03-08	SOPORTE PARA TRANSMISIÓN	
L6 5.9	03-04	SOPORTE PARA TRANSMISIÓN STD.	7463
V8 3.9 V8 5.2 V8 5.9	94-00	SOPORTE PARA MOTOR DERECHO	1912
		REPUESTO PARA SOPORTE DE MOTOR DERECHO (1912)	1912-9
		SOPORTE PARA MOTOR IZQUIERDO	1913
		REPUESTO PARA SOPORTE DE MOTOR IZQUIERDO (1913)	1913-9

**SOPORTES
TRANSMISSION & MOTOR MOUNTS**



1912



1912-9



1913



1913-9



7463



7577



CONTINUACIÓN... RAM 3500

  28		APLICACIÓN / DESCRIPTION	DAI PARTS #
SOPORTES / TRANSMISION & MOTOR MOUNTS			
V8 3.9 V8 5.2 V8 5.9	94-00	REPUESTO SOPORTE PARA MOTOR DERECHO	1914-9
		REPUESTO SOPORTE PARA MOTOR IZQUIERDO	1915-9
		SOPORTE PARA TRANSMISIÓN	1917
		SOPORTE PARA TRANSMISIÓN	1918
		SOPORTE PARA TRANSMISIÓN (REFORZADO)	1919
V8 4.7 V8 5.7 V8 5.9	01-05	SOPORTE PARA MOTOR DERECHO	7181
		SOPORTE PARA MOTOR IZQUIERDO	7180
		REPUESTO PARA SOPORTE DE MOTOR IZQUIERDO Y DERECHO (7180 Y 7181)	7180-9
V8 5.9	03-08	SOPORTE PARA MOTOR IZQUIERDO Y DERECHO	7545
V10 8.0	2003	SOPORTE PARA MOTOR IZQUIERDO Y DERECHO (MOTOR DIESEL CUMMINS)	



MISCELÁNEOS / AUTOMOTIVE RUBBER PARTS		
70-78	TORNILLO EXCENTRICO VAM Y WAGON	64600
94-05	GOMA SUJETADORA DE ESCAPE	6566



CONTINUACIÓN... RAM 3500

	 28	APLICACIÓN / DESCRIPTION	DAI PARTS #
MISCELÁNEOS / AUTOMOTIVE RUBBER PARTS			
	94-02	GOMA PARA BARRA ESTABILIZADORA (4X2) SUSP. INDEPENDIENTE	64692

**MISCELÁNEOS
AUTOMOTIVE RUBBER PARTS**



64692

RAM 4500

SOPORTES / TRANSMISSION & MOTOR MOUNTS			
L6 5.7	08-13	SOPORTE PARA TRANSMISIÓN (GAS)	7577
L6 6.7		SOPORTE PARA TRANSMISIÓN (DIESEL)	
V8 5.9	03-08	SOPORTE PARA TRANSMISIÓN	
V8 5.9	03-08	SOPORTE PARA MOTOR IZQUIERDO Y DERECHO	7545
V10 8.0	2003	SOPORTE PARA MOTOR IZQUIERDO Y DERECHO (MOTOR DIESEL CUMMINS)	

**SOPORTES
TRANSMISSION & MOTOR MOUNTS**



7545 **7577**

RAM CARGO VAN TRADESMAN

SOPORTES / TRANSMISSION & MOTOR MOUNTS			
V6 3.6	10-16	REPUESTO PARA SOPORTE DE TRANSMISIÓN (7337)	7337-9

**SOPORTES
TRANSMISSION & MOTOR MOUNTS**



7337-9



RAM CHARGER

 		APLICACIÓN / DESCRIPTION	DAI PARTS #
SOPORTES / TRANSMISSION & MOTOR MOUNTS			
V6 3.7	74-94	SOPORTE PARA MOTOR IZQUIERDO Y DERECHO	1796
		SOPORTE PARA TRANSMISIÓN STD.	1894
		SOPORTE PARA TRANSMISIÓN STD.	1776
V8 5.9	74-94	SOPORTE PARA TRANSMISIÓN	6653
	99-01	SOPORTE PARA MOTOR IZQUIERDO Y DERECHO	1892
		SOPORTE PARA MOTOR IZQUIERDO	1891
74-01	SOPORTE PARA TRANSMISIÓN STD.	1894	
V8 7.2	74-94	SOPORTE PARA TRANSMISIÓN STD.	1894
		SOPORTE PARA TRANSMISIÓN	6653

**SOPORTES
TRANSMISSION & MOTOR MOUNTS**

1776

1796

1891

1892

1894

1895

6653
MISCELÁNEOS / AUTOMOTIVE RUBBER PARTS

71-93	GOMA PARA BARRA ESTABILIZADORA (4X2)	64692
	GOMA PARA TIRANTE DE SUSPENSIÓN (4X2)	64500
72-93	BRAZO AUXILIAR DE DIRECCIÓN (4X2)	DAI-7055
	TORNILLO EXCENTRICO (4X2)	64600
94-02	TORNILLO ESTABILIZADOR (LARGO)	6099

**MISCELÁNEOS
AUTOMOTIVE RUBBER PARTS**

6099



64500

64600

64692

DAI-7055

SEBRING

 		APLICACIÓN / DESCRIPTION	DAI PARTS #
SOPORTES / TRANSMISSION & MOTOR MOUNTS			
L4 2.0	95-99	SOPORTE PARA MOTOR FRONTAL	6787
		SOPORTE PARA MOTOR FRONTAL	7787
L4 2.4	96-99	REPUESTO PARA SOPORTE DE MOTOR FRONTAL (6698, 6900 Y 6901)	6787
		SOPORTE PARA MOTOR FRONTAL CON DISTANCIA ENTRE TUERCAS DE FIJACIÓN A 92 mm	6900
		SOPORTE PARA MOTOR FRONTAL CON DISTANCIA ENTRE TUERCAS DE FIJACIÓN A 76 mm	6901
		SOPORTE MOTOR TRASERO	6899
		REPUESTO PARA SOPORTE DE MOTOR TRASERO (6698 Y 6899)	6785
	96-05	SOPORTE PARA TRANSMISIÓN	6849
		SOPORTE PARA MOTOR DERECHO	6851
	01-05	SOPORTE PARA TRANSMISIÓN AUT.	7734
		SOPORTE PARA MOTOR TRASERO <i>COUPE</i>	7752
		SOPORTE PARA MOTOR FRONTAL <i>COUPE</i>	7784
	07-11	SOPORTE PARA MOTOR FRONTAL	7279
		REPUESTO PARA SOPORTE DE MOTOR FRONTAL Y TRASERO BUJE INTERNO GRANDE OVALADO (7279 Y 7310)	7279-9
SOPORTE PARA MOTOR TRASERO		7310	



CONTINUACIÓN... SEBRING

		APLICACIÓN / DESCRIPTION	DAI PARTS #
SOPORTES / TRANSMISSION & MOTOR MOUNTS			
L4 2.4	07-11	SOPORTE PARA MOTOR DERECHO	7329-H
		SOPORTE PARA TRANSMISIÓN	7337
L4 2.5	95-99	SOPORTE PARA MOTOR FRONTAL	6787
		SOPORTE PARA MOTOR FRONTAL	7787
V6 2.7	01-06	SOPORTE PARA TRANSMISIÓN	6849
		SOPORTE PARA MOTOR DERECHO	6851
		SOPORTE PARA MOTOR TRASERO	7018
		SOPORTE PARA MOTOR FRONTAL	7068
V6 3.0	2001	SOPORTE PARA MOTOR TRASERO <i>LX Y JR</i>	7418-9
		SOPORTE PARA MOTOR TRASERO (LX Y JR)	7786
	01-05	REPUESTO PARA SOPORTE DE TRANSMISIÓN <i>MOTOR MITSUBISHI LX Y SR</i>	7418-9
	01-05	SOPORTE PARA MOTOR FRONTAL <i>COUPE</i>	7784
V6 3.5	07-10	SOPORTE PARA MOTOR TRASERO	7310
		SOPORTE MOTOR FRONTAL	7279
		REPUESTO PARA SOPORTE DE MOTOR FRONTAL Y TRASERO BUJE INTERNO GRANDE OVALADO (7279 Y 7310)	7279-9
	08-10	REPUESTO PARA SOPORTE DE TRANSMISIÓN (7337)	7337-9

**SOPORTES
TRANSMISSION & MOTOR MOUNTS**

6849

6851

7018

7068

7279

7279-9

7310

7329-H

7337

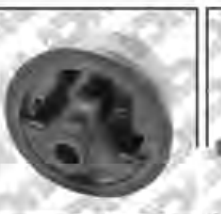
7337-9

7418-9

7784

7786

7787

CONTINUACIÓN... SEBRING

28	APLICACIÓN / DESCRIPTION	DAI PARTS #	DAI KIT PARTS #
BASES PARA AMORTIGUADOR / STRUT MOUNTS			
89-95	BASE PARA AMORTIGUADOR FRONTAL IZQUIERDA Y DERECHA	6636	
	BASE PARA AMORTIGUADOR FRONTAL IZQUIERDA Y DERECHA	6650	6650-KIT
	BALERO PARA BASE DE AMORTIGUADOR 6636, 6650 Y 6650-KIT	6140	



28	APLICACIÓN / DESCRIPTION	DAI PARTS #
MISCELÁNEOS / AUTOMOTIVE RUBBER PARTS		
95-06	BUJE PARA HORQUILLA INFERIOR CHICO	DAI-4616939
07-08	TORNILLO ESTABILIZADOR	DAI-2106016
01-06	TORNILLO ESTABILIZADOR FRONTAL IZQUIERDO <i>COUPE</i>	DAI-2115001
	TORNILLO ESTABILIZADOR FRONTAL DERECHO <i>COUPE</i>	DAI-2115002



SERIE 800 Y 900 [PERKINS]

 		APLICACIÓN / DESCRIPTION	DAI PARTS #
SOPORTES / TRANSMISSION & MOTOR MOUNTS			
L6 3.7	54-75	SOPORTE PARA MOTOR TRASERO	1127
L6 5.8	80-85	SOPORTE PARA MOTOR FRONTAL IZQUIERDO Y DERECHO	1804





SERIE CT 800 Y CT 900 [PERKINS]

SOPORTES / TRANSMISSION & MOTOR MOUNTS			
L6 354	59-92	SOPORTE PARA TRANSMISIÓN IZQUIERDO Y DERECHO	1643
		SOPORTE PARA MOTOR IZQUIERDO Y DERECHO	1678
		SOPORTE PARA MOTOR CENTRAL INFERIOR	1680
		SOPORTE PARA MOTOR IZQUIERDO Y DERECHO	1706
	97-99	SOPORTE PARA MOTOR IZQUIERDO Y DERECHO	6799



SHADOW

  28		APLICACIÓN / DESCRIPTION	DAI PARTS #
SOPORTES / TRANSMISSION & MOTOR MOUNTS			
L4 2.2	89-90	SOPORTE DE TORSIÓN TRASERO	1809
		SOPORTE PARA MOTOR FRONTAL	1910
		REPUESTO PARA SOPORTE DE MOTOR FRONTAL (1910)	1868
		REPUESTO PARA SOPORTE DE TRANSMISIÓN (1827)	2354
90-95	REPUESTO PARA SOPORTE DE TRANSMISIÓN (6668)	1928	
L4 2.5	91-95	SOPORTE PARA MOTOR FRONTAL	6651
		REPUESTO PARA SOPORTE DE MOTOR FRONTAL (6651)	1927
		SOPORTE PARA MOTOR DERECHO	6652
		REPUESTO PARA SOPORTE MOTOR DERECHO (6652)	1973
		SOPORTE PARA TRANSMISIÓN	6668
		REPUESTO PARA SOPORTE DE TRANSMISIÓN (6668)	1928
V6 3.0	92-94	SOPORTE PARA MOTOR DERECHO	6913
		SOPORTE PARA MOTOR FRONTAL	6651
		REPUESTO PARA SOPORTE DE MOTOR FRONTAL (6651)	1927
		SOPORTE PARA MOTOR DERECHO	6913-H
		SOPORTE PARA TRANSMISIÓN	6668
		REPUESTO PARA SOPORTE DE TRANSMISIÓN (6668)	1928
89-95	SOPORTE PARA ALTERNADOR	6830	

**SOPORTES
TRANSMISSION & MOTOR MOUNTS**

	
1809	1868
	
1910	1927
	
1928	1973
	
2354	6651
	
6652	6668

		
6830	6913	6913-H



CONTINUACIÓN... SHADOW

 28		APLICACIÓN / DESCRIPTION	DAI PARTS #	DAI KIT PARTS #
BASES PARA AMORTIGUADOR / STRUT MOUNTS				
89-95	BASE PARA AMORTIGUADOR FRONTAL IZQUIERDA Y DERECHA	6636		
	BASE PARA AMORTIGUADOR FRONTAL IZQUIERDA Y DERECHA	6650	6650-KIT	
	BALERO PARA BASE DE AMORTIGUADOR 6636, 6650 Y 6650-KIT	6140		



 28		APLICACIÓN / DESCRIPTION	DAI PARTS #
CUBRE POLVOS / C.V. BOOTS			
89-95	CUBRE POLVO IZQUIERDO Y DERECHO LADO RUEDA	6304	
	CUBRE POLVO IZQUIERDO Y DERECHO LADO RUEDA	6306	
	CUBRE POLVO DERECHO LADO CAJA	6330	
	CUBRE POLVO DERECHO LADO CAJA	6353	
	CUBRE POLVO IZQUIERDO Y DERECHO LADO RUEDA	6350	
	CUBRE POLVO IZQUIERDO Y DERECHO DIRECCIÓN STD.	6363	
	CUBRE POLVO IZQUIERDO Y DERECHO DIRECCIÓN HID.	6364	



CONTINUACIÓN... SHADOW

 		APLICACIÓN / DESCRIPTION	DAI PARTS #
CUBRE POLVOS / C.V. BOOTS			
89-95		CUBRE POLVO DERECHO LADO CAJA	6375
		CUBRE POLVO IZQUIERDO Y DERECHO LADO RUEDA	6380
		CUBRE POLVO IZQUIERDO Y DERECHO DE DIRECCIÓN HID.	6381
		CUBREPOLVO DERECHO LADO CAJA	6391
		CUBRE POLVO IZQUIERDO Y DERECHO LADO RUEDA (FLECHA IMPORTADA)	6396



MISCELÁNEOS / AUTOMOTIVE RUBBER PARTS			
89-94		TOPE PARA AMORTIGUADOR FRONTAL IZQUIERDO Y DERECHO	D-0622
		TOPE PARA AMORTIGUADOR FRONTAL Y TRASERO IZQUIERDO Y DERECHO	D-0621
		GOMA PARA BARRA ESTABILIZADORA	6413
		GOMA PARA BARRA ESTABILIZADORA	6414
		GOMA SUJETADORA DE ESCAPE	6546

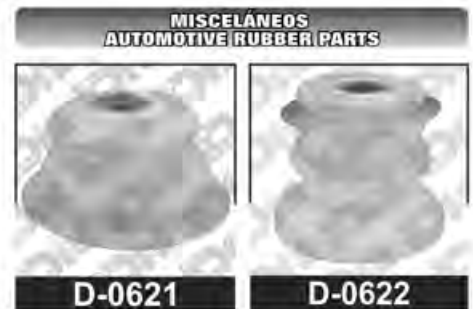

SPIRIT

 28		APLICACIÓN / DESCRIPTION	DAI PARTS #
SOPORTES / TRANSMISSION & MOTOR MOUNTS			
L4 2.2	90-93	SOPORTE PARA MOTOR FRONTAL	6651
		REPUESTO PARA SOPORTE DE MOTOR FRONTAL (6651)	1927
		SOPORTE PARA MOTOR DERECHO	6652
		REPUESTO PARA SOPORTE MOTOR DERECHO (6652)	1973
		SOPORTE PARA TRANSMISIÓN	6668
		REPUESTO PARA SOPORTE DE TRANSMISIÓN (6668)	1928
L4 2.5	94-95	SOPORTE PARA MOTOR FRONTAL	6651
		REPUESTO PARA SOPORTE DE MOTOR FRONTAL (6651)	1927
		SOPORTE PARA MOTOR DERECHO	6652
		REPUESTO PARA SOPORTE MOTOR DERECHO (6652)	1973
		SOPORTE PARA TRANSMISIÓN	6668
		REPUESTO PARA SOPORTE DE TRANSMISIÓN (6668)	1928
	89-95	SOPORTE PARA ALTERNADOR	6830

**SOPORTES
TRANSMISSION & MOTOR MOUNTS**

1927

1928

1973

6651

6652

6668

6830

 28		APLICACIÓN / DESCRIPTION	DAI PARTS #	DAI KIT PARTS #
BASES PARA AMORTIGUADOR / STRUT MOUNTS				
1989		BASE PARA AMORTIGUADOR FRONTAL IZQUIERDA Y DERECHA	6650	6650-KIT

**BASES PARA AMORTIGUADOR
STRUT MOUNTS**

6650

6650-KIT

CONTINUACIÓN... SPIRIT

28		APLICACIÓN / DESCRIPTION	DAI PARTS #	DAI KIT PARTS #
BASES PARA AMORTIGUADOR / STRUT MOUNTS				
89-95	BASE PARA AMORTIGUADOR FRONTAL IZQUIERDA Y DERECHA		6636	
	BALERO PARA BASES DE AMORTIGUADOR 6636, 6650 Y 6650-KIT		6140	



28		APLICACIÓN / DESCRIPTION	DAI PARTS #
CUBRE POLVOS / C.V. BOOTS			
89-95	CUBRE POLVO IZQUIERDO Y DERECHO LADO RUEDA		6304
	CUBRE POLVO IZQUIERDO Y DERECHO LADO RUEDA		6306
	CUBRE POLVO DERECHO LADO CAJA		6330
	CUBRE POLVO IZQUIERDO Y DERECHO LADO RUEDA		6350
	CUBRE POLVO DERECHO LADO CAJA		6353
	CUBRE POLVO IZQUIERDO Y DERECHO DIRECCIÓN STD.		6363
	CUBRE POLVO IZQUIERDO Y DERECHO DIRECCIÓN HID.		6364
	CUBRE POLVO DERECHO LADO CAJA		6375
	CUBRE POLVO IZQUIERDO Y DERECHO LADO RUEDA		6380
	CUBRE POLVO IZQUIERDO Y DERECHO DE DIRECCIÓN HID.		6381



CONTINUACIÓN... SPIRIT



		APLICACIÓN / DESCRIPTION	DAI PARTS #
MISCELÁNEOS / AUTOMOTIVE RUBBER PARTS			
89-95	TOPE PARA AMORTIGUADOR FRONTAL IZQUIERDO Y DERECHO		D-0622
	TOPE PARA AMORTIGUADOR FRONTAL Y TRASERO IZQUIERDO Y DERECHO		D-0621
	GOMA PARA BARRA ESTABILIZADORA		6414

STRATUS

SOPORTES / TRANSMISSION & MOTOR MOUNTS				
L4 2.0	96-06	REPUESTO PARA SOPORTE DE MOTOR TRASERO (6698 Y 6899)	6785	
		REPUESTO PARA SOPORTE DE MOTOR FRONTAL (6698, 6900 Y 6901)	6787	
		SOPORTE PARA TRANSMISIÓN	6849	
	01-06	SOPORTE PARA MOTOR DERECHO		6851
		SOPORTE PARA MOTOR FRONTAL CON DISTANCIA ENTRE TUERCAS DE FIJACIÓN A 92 mm		6900
		SOPORTE PARA MOTOR FRONTAL CON DISTANCIA ENTRE TUERCAS DE FIJACIÓN A 76 mm		6901



CONTINUACIÓN... STRATUS

 		APLICACIÓN / DESCRIPTION	DAI PARTS #
SOPORTES / TRANSMISSION & MOTOR MOUNTS			
L4 2.0	01-06	SOPORTE PARA MOTOR TRASERO	6899
L4 2.4	96-00	REPUESTO PARA SOPORTE DE MOTOR TRASERO (6698 Y 6899)	6785
		REPUESTO PARA SOPORTE DE MOTOR FRONTAL (6698, 6900 Y 6901)	6787
	96-08	SOPORTE PARA TRANSMISIÓN	6849
		SOPORTE PARA MOTOR DERECHO	6851
	01-05	SOPORTE PARA MOTOR FRONTAL AUT. MOTOR MITSUBISHI (USA)	7422
		REPUESTO PARA SOPORTE DERECHO DE MOTOR MOTOR MITSUBISHI (USA)	7417-9
		SOPORTE PARA MOTOR TRASERO COUPE	7752
		SOPORTE PARA MOTOR FRONTAL	7784
	01-06	SOPORTE PARA TRANSMISIÓN AUT.	7734
	01-08	SOPORTE PARA MOTOR FRONTAL	7068
SOPORTE PARA MOTOR TRASERO		7018	
L4 2.0 L4 2.4	96-00	SOPORTE PARA MOTOR FRONTAL Y TRASERO (PUENTE)	6698
V6 3.0	96-00	SOPORTE PARA MOTOR FRONTAL	7784
		SOPORTE PARA MOTOR TRASERO MOTOR MITSUBISHI (USA)	7786



CONTINUACIÓN... STRATUS

28		APLICACIÓN / DESCRIPTION	DAI PARTS #	DAI KIT PARTS #
BASES PARA AMORTIGUADOR / STRUT MOUNTS				
95-00	BASE PARA AMORTIGUADOR FRONTAL IZQUIERDA Y DERECHA		6736	6736-KIT
	BASE PARA AMORTIGUADOR TRASERA IZQUIERDA Y DERECHA		6750	6750-KIT
	BASE PARA AMORTIGUADOR FRONTAL IZQUIERDA Y DERECHA		6755	





28		APLICACIÓN / DESCRIPTION	DAI PARTS #
CUBRE POLVOS / C.V. BOOTS			
95-08	CUBRE POLVO DERECHO LADO CAJA (CON TRIPOIDE)		6310
	CUBRE POLVO IZQUIERDO LADO CAJA (CON TRIPOIDE)		6398



MISCELÁNEOS / AUTOMOTIVE RUBBER PARTS			
95-00	GOMA PARA CREMALLERA DE DIRECCIÓN HID. (DERECHA PAR 713)		712
	GOMA PARA CREMALLERA DE DIRECCIÓN HID., (IZQUIERDA PAR 712)		713



CONTINUACIÓN... STRATUS

 		APLICACIÓN / DESCRIPTION	DAI PARTS #
MISCELÁNEOS / AUTOMOTIVE RUBBER PARTS			
	95-04	TORNILLO ESTABILIZADOR	4695626
	95-06	BUJE PARA HORQUILLA INFERIOR CHICO	DAI-4616939
	95-08	GOMA SUJETADORA DE ESCAPE	6572
		GOMA PARA BARRA ESTABILIZADORA	64737



SUPER BEE

SOPORTES / TRANSMISSION & MOTOR MOUNTS			
V8 5.2 V8 5.9	67-72	SOPORTE PARA MOTOR IZQUIERDO Y DERECHO	1743



MISCELÁNEOS / AUTOMOTIVE RUBBER PARTS			
	62-72	TORNILLO ESTABILIZADOR (6", 177.8 mm)	6101
		TORNILLO ESTABILIZADOR (6", 177.8 mm) E.P.	6105
	62-76	TORNILLO EXCENTRICO	64600
		GOMA PARA TIRANTE DE SUSPENSIÓN	64570
	73-76	TORNILLO ESTABILIZADOR (5", 1542.4 mm)	6100
		TORNILLO ESTABILIZADOR (5", 1542.4 mm) E.P.	6104

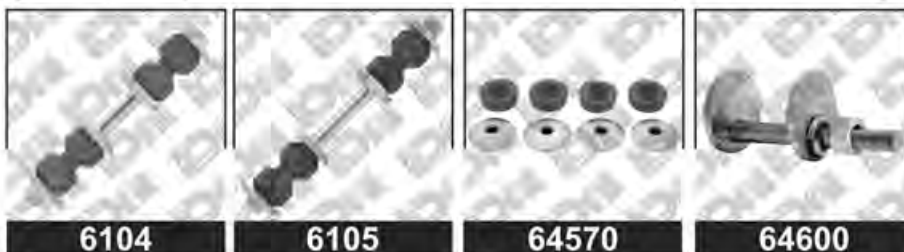

CONTINUACIÓN... SUPER BEE

		APLICACIÓN / DESCRIPTION	DAI PARTS #
MISCELÁNEOS / AUTOMOTIVE RUBBER PARTS			
77-82	TORNILLO ESTABILIZADOR FRONTAL IZQUIERDO Y DERECHO (CORTO)		6098
	TORNILLO ESTABILIZADOR		64590

TOWN & COUNTRY



SOPORTES / TRANSMISSION & MOTOR MOUNTS			
V6 3.3	90-95	SOPORTE PARA MOTOR FRONTAL	6651
		REPUESTO PARA SOPORTE DE MOTOR FRONTAL (6651)	1927
		SOPORTE PARA MOTOR DERECHO	6652
		REPUESTO PARA SOPORTE MOTOR DERECHO (6652)	1973
		SOPORTE PARA MOTOR DERECHO	6913
		SOPORTE PARA MOTOR DERECHO	6913-H
	08-10	SOPORTE PARA TRANSMISIÓN	6668
		REPUESTO PARA SOPORTE DE TRANSMISIÓN (6668)	1928
		SOPORTE PARA MOTOR TRASERO	7310
		REPUESTO PARA SOPORTE DE MOTOR FRONTAL	7716-9



NUEVO



CONTINUACIÓN... TOWN & COUNTRY

 		APLICACIÓN / DESCRIPTION	DAI PARTS #
SOPORTES / TRANSMISSION & MOTOR MOUNTS			
V6 3.3	08-10	REPUESTO PARA SOPORTE DE MOTOR TRASERO	7723-9
V6 3.6	11-14	SOPORTE PARA MOTOR TRASERO	7310
		SOPORTE PARA MOTOR FRONTAL	7279
		SOPORTE PARA TRANSMISIÓN AUT.	7426
	11-16	REPUESTO PARA SOPORTE DE TRANSMISIÓN (7337)	7337-9
V6 3.8	96-00	SOPORTE PARA MOTOR FRONTAL	6938
		REPUESTO PARA MOTOR DERECHO	6942
		REPUESTO PARA SOPORTE DE MOTOR DERECHO (6942)	6950
		SOPORTE PARA TRANSMISIÓN	7012
		REPUESTO PARA SOPORTE DE MOTOR FRONTAL Y TRANSMISIÓN (6938 Y 7012)	7012-9
		SOPORTE PARA TRANSMISIÓN AUT.	7028
	01-07	SOPORTE PARA MOTOR FRONTAL	7119
		REPUESTO PARA SOPORTE DE MOTOR FRONTAL (7119)	7119-9
		SOPORTE PARA MOTOR TRASERO	7122



CONTINUACIÓN... TOWN & COUNTRY

		APLICACIÓN / DESCRIPTION	DAI PARTS #
SOPORTES / TRANSMISSION & MOTOR MOUNTS			
V6 3.8	01-07	SOPORTE PARA MOTOR DERECHO	7121-H
		SOPORTE PARA TRANSMISIÓN AUT.	7054
V6 3.3	08-10	SOPORTE PARA MOTOR DERECHO	7567-H
V6 4.0			
V6 3.6	11-15		
V6 3.8 V6 4.0	08-10	SOPORTE PARA MOTOR TRASERO	7310
		SOPORTE PARA MOTOR FRONTAL	7279
		SOPORTE PARA TRANSMISIÓN AUT.	7426
		REPUESTO PARA SOPORTE DE MOTOR FRONTAL	7716-9
		REPUESTO PARA SOPORTE DE MOTOR TRASERO	7723-9
V6 4.0	08-10	REPUESTO PARA SOPORTE DE TRANSMISIÓN (7337)	7337-9



		APLICACIÓN / DESCRIPTION	DAI PARTS #	DAI KIT PARTS #
BASES PARA AMORTIGUADOR / STRUT MOUNTS				
91-95		BASE PARA AMORTIGUADOR FRONTAL IZQUIERDA Y DERECHA	6636	
		BASE PARA AMORTIGUADOR FRONTAL IZQUIERDA Y DERECHA	6650	6650-KIT



CONTINUACIÓN... TOWN & COUNTRY

28	APLICACIÓN / DESCRIPTION	DAI PARTS #	DAI KIT PARTS #
BASES PARA AMORTIGUADOR / STRUT MOUNTS			
91-95	BALERO PARA BASES DE AMORTIGUADOR 6636, 6650 Y 6650-KIT	6140	
96-00	BASE PARA AMORTIGUADOR FRONTAL IZQUIERDA Y DERECHA	7015	7015-KIT
01-07	BASE PARA AMORTIGUADOR FRONTAL IZQUIERDA Y DERECHA	7051	7051-KIT
08-14	BASE PARA AMORTIGUADOR FRONTAL IZQUIERDA Y DERECHA	7332	



28	APLICACIÓN / DESCRIPTION	DAI PARTS #
CUBRE POLVOS / C.V. BOOTS		
91-95	CUBRE POLVO IZQUIERDO Y DERECHO LADO RUEDA	6350
96-00	CUBRE POLVO IZQUIERDO Y DERECHO LADO RUEDA	6394



MISCELÁNEOS / AUTOMOTIVE RUBBER PARTS			
91-95	GOMA PARA BARRA ESTABILIZADORA	64717	
96-07	TORNILLO ESTABILIZADOR FRONTAL	DAI-K-7258	



CONTINUACIÓN... TOWN & COUNTRY

 		APLICACIÓN / DESCRIPTION	DAI PARTS #
MISCELÁNEOS / AUTOMOTIVE RUBBER PARTS			
96-07		BUJE PARA HORQUILLA	DAI-1406012
		BUJE PARA HORQUILLA INFERIOR CHICO	DAI-4689120
01-07		BUJE PARA HORQUILLA GRANDE	DAI-1406014
08-12		TORNILLO ESTABILIZADOR FRONTAL	DAI-2106017
08-14		BUJE PARA HORQUILLA INFERIOR CHICO	DAI-1406048
		BUJE PARA HORQUILLA INFERIOR GRANDE	DAI-1406055

DAI-2106017

DAI-4689120

**MISCELÁNEOS
AUTOMOTIVE RUBBER PARTS**



DAI-1406012



DAI-1406014



DAI-1406048



DAI-1406055

VALIANT

SOPORTES / TRANSMISSION & MOTOR MOUNTS			
L6 2.8 L6 3.7	63-73	SOPORTE PARA MOTOR IZQUIERDO	1646
		SOPORTE PARA MOTOR DERECHO STD.	1657
		SOPORTE PARA TRANSMISIÓN STD. Y AUT.	1648
	67-73	SOPORTE PARA MOTOR IZQUIERDO	1664
		SOPORTE PARA MOTOR IZQUIERDO AUT.	1761
	73-82	SOPORTE PARA MOTOR DERECHO	1763
SOPORTE PARA MOTOR IZQUIERDO		1764	

1761

1763

1764

**SOPORTES
TRANSMISSION & MOTOR MOUNTS**



1646



1648



1657



1664



CONTINUACIÓN... VALIANT

		 28	APLICACIÓN / DESCRIPTION	DAI PARTS #
SOPORTES / TRANSMISSION & MOTOR MOUNTS				
L6 2.8 L6 3.7	73-82	REPUESTO PARA SOPORTE DE TRANSMISIÓN STD. Y AUT., (1762 Y 1775)		2349
		SOPORTE PARA TRANSMISIÓN STD.		1775
V8 5.2 V8 5.9	67-72	SOPORTE PARA MOTOR IZQUIERDO Y DERECHO		1743



MISCELÁNEOS / AUTOMOTIVE RUBBER PARTS			
62-69	GOMAS PARA TIRANTE DE SUSPENSIÓN		6046
	62-72	TORNILLO ESTABILIZADOR (6", 177.8 mm)	6101
		TORNILLO ESTABILIZADOR (6", 177.8 mm EQUIPO ORIGINAL)	6105
62-76	TAPON PARA BOMBA DE AGUA 5/8"		6010
		GOMA PARA TIRANTE DE SUSPENSIÓN	64570
	TORNILLO EXCENTRICO		64600
70-76	GOMAS PARA TIRANTE DE SUSPENSIÓN		6055
77-82	TORNILLO ESTABILIZADOR FRONTAL IZQUIERDO Y DERECHO (CORTO)		6098
	TORNILLO ESTABILIZADOR		64590

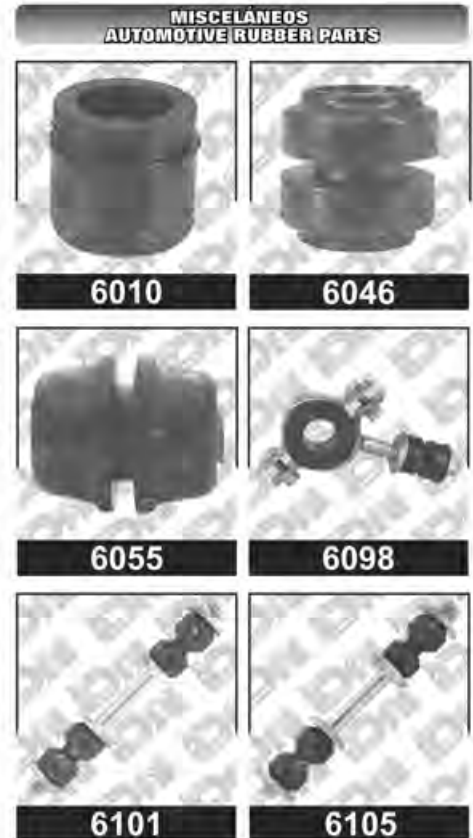

CONTINUACIÓN... VALIANT

	28	APLICACIÓN / DESCRIPTION	DAI PARTS #
MISCELÁNEOS / AUTOMOTIVE RUBBER PARTS			
73-76		TORNILLO ESTABILIZADOR (5", 1542.4 mm)	6100
		TORNILLO ESTABILIZADOR (5", 1542.4 mm EQUIPO ORIGINAL)	6104

VAM



MISCELÁNEOS / AUTOMOTIVE RUBBER PARTS		
	TOPE PARA SUSPENSIÓN DELANTERA (DIAM. 47 mm ALT. 65 mm)	351

VARIOS

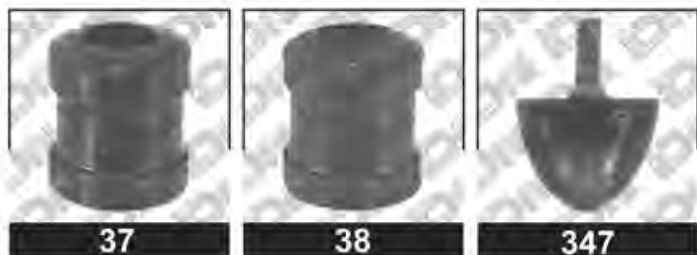
MISCELÁNEOS / AUTOMOTIVE RUBBER PARTS		
	GOMA PARA AMORTIGUADOR CÓNICA	34
	GOMA PARA AMORTIGUADOR CÓNICA	36
	GOMA PARA AMORTIGUADOR CARRETE	37
	GOMA PARA AMORTIGUADOR CARRETE	38
	TOPE PARA SUSPENSIÓN HORQUILLA (DIAM. 40 mm ALT. 35 mm)	347



CONTINUACIÓN... VARIOS

	 28	APLICACIÓN / DESCRIPTION	DAI PARTS #
MISCELÁNEOS / AUTOMOTIVE RUBBER PARTS			
	66-75	GOMA PARA BARRA ESTABILIZADORA	512
	69-88	COPLÉ PARA DIRECCIÓN STD. (SINFIN REDONDO DE .725 mm 2 PERNOS DELGADOS)	602
	79-08	COPLÉ PARA DIRECCIÓN HID. ALGUNOS DIRECCIÓN STD. (SINFIN REBAJADO DE .725" 2 PERNOS DELGADOS)	605
	79-08	COPLÉ PARA DIRECCIÓN HID. (SINFIN REBAJADO DE .810" 2 PERNOS DELGADOS)	606
	65-08	GALLETAS PARA DIRECCIÓN STD. (2 PERNOS DELGADOS) COMPLETO 602, 610, 608 Y 614	622
		CUBRE POLVO PARA PALANCA DE VELOCIDADES	6556



VOLARE K

SOPORTES / TRANSMISSION & MOTOR MOUNTS			
L4 2.2	82-89	SOPORTE PARA MOTOR DERECHO	1810
L4 2.5		SOPORTE PARA MOTOR FRONTAL	1910



CONTINUACIÓN... VOLARE K

 		APLICACIÓN / DESCRIPTION	DAI PARTS #
SOPORTES / TRANSMISSION & MOTOR MOUNTS			
L4 2.2 L4 2.5	82-89	REPUESTO PARA SOPORTE DE MOTOR FRONTAL (1910)	1868
		REPUESTO PARA SOPORTE DE TRANSMISIÓN (1827)	2354
		SOPORTE DE TORSIÓN TRASERO	1809



	APLICACIÓN / DESCRIPTION	DAI PARTS #	DAI KIT PARTS #
BASES PARA AMORTIGUADOR / STRUT MOUNTS			
82-83	BASE PARA AMORTIGUADOR FRONTAL IZQUIERDA Y DERECHA	1808	1808-KIT
84-85	BASE PARA AMORTIGUADOR FRONTAL IZQUIERDA Y DERECHA	1820	1820-KIT
86-88	BASE PARA AMORTIGUADOR FRONTAL IZQUIERDA Y DERECHA	6636	
	BASE PARA AMORTIGUADOR FRONTAL IZQUIERDA Y DERECHA	6650	6650-KIT
	BALERO PARA BASE DE AMORTIGUADOR 6636, 6650 Y 6650-KIT	6140	
84-88	BASE PARA AMORTIGUADOR FRONTAL IZQUIERDA Y DERECHA	6641	



CONTINUACIÓN... VOLARE K

28		APLICACIÓN / DESCRIPTION	DAI PARTS #	DAI KIT PARTS #
BASES PARA AMORTIGUADOR / STRUT MOUNTS				
84-88	BASE PARA AMORTIGUADOR FRONTAL IZQUIERDA Y DERECHA			6758-KIT
	BALERO PARA BASES DE AMORTIGUADOR 6641, 6758 Y 6758-KIT		6141	



28		APLICACIÓN / DESCRIPTION	DAI PARTS #
CUBRE POLVOS / C.V. BOOTS			
82-88	CUBRE POLVO IZQUIERDO Y DERECHO LADO RUEDA		6304
	CUBRE POLVO IZQUIERDO Y DERECHO LADO RUEDA		6306
	CUBRE POLVO DERECHO LADO CAJA		6330
	CUBRE POLVO IZQUIERDO Y DERECHO LADO RUEDA		6350
	CUBRE POLVO DERECHO LADO CAJA		6353
	CUBRE POLVO IZQUIERDO Y DERECHO DIRECCIÓN STD.		6363
	CUBRE POLVO IZQUIERDO Y DERECHO DIRECCIÓN HID.		6364
	CUBRE POLVO DERECHO LADO CAJA		6375



CONTINUACIÓN... VOLARE K

		APLICACIÓN / DESCRIPTION	DAI PARTS #	MISCELÁNEOS AUTOMOTIVE RUBBER PARTS	
MISCELÁNEOS / AUTOMOTIVE RUBBER PARTS					
62-72		TORNILLO ESTABILIZADOR (6", 177.800 mm)	6101	 D-0619	 D-0622
		TORNILLO ESTABILIZADOR (6", 177.8 mm EQUIPO ORIGINAL)	6105		
62-76		GOMA PARA TIRANTE DE SUSPENSIÓN	64570	 6098	 6100
		TORNILLO EXCENTRICO	64600		
73-76		TORNILLO ESTABILIZADOR (5", 1542.4 mm)	6100	 6101	 6104
		TORNILLO ESTABILIZADOR (5", 1542.4 mm EQUIPO ORIGINAL)	6104		
77-82		TORNILLO ESTABILIZADOR FRONTAL IZQUIERDO Y DERECHO (CORTO)	6098	 6105	 6548
		TORNILLO ESTABILIZADOR	64590		
82-88		TOPE PARA AMORTIGUADOR FRONTAL IZQUIERDO Y DERECHO	D-0619	 64600	
		TOPE PARA AMORTIGUADOR FRONTAL IZQUIERDO Y DERECHO	D-0622		
		GOMA SUJETADORA DE ESCAPE (TIRANTE)	6548		
		GOMA SUJETADORA DE ESCAPE	6549		
		GOMA PARA TIRANTE DE SUSPENSIÓN	64490		



VOYAGER

 		APLICACIÓN / DESCRIPTION	DAI PARTS #
SOPORTES / TRANSMISSION & MOTOR MOUNTS			
V6 3.3	90-95	SOPORTE PARA MOTOR FRONTAL	6651
		REPUESTO PARA SOPORTE DE MOTOR FRONTAL (6651)	1927
		SOPORTE PARA MOTOR DERECHO	6652
		REPUESTO PARA SOPORTE MOTOR DERECHO (6652)	1973
		SOPORTE PARA MOTOR DERECHO	6913
		SOPORTE PARA MOTOR DERECHO	6913-H
		SOPORTE PARA TRANSMISIÓN	6668
		REPUESTO PARA SOPORTE DE TRANSMISIÓN (6668)	1928

V6 3.8	96-00	SOPORTE PARA MOTOR DERECHO	6942
		SOPORTE PARA MOTOR FRONTAL	6938
		SOPORTE PARA TRANSMISIÓN	7012
		REPUESTO PARA SOPORTE DE MOTOR FRONTAL Y TRANSMISIÓN (6938 Y 7012)	7012-9
		SOPORTE PARA TRANSMISIÓN AUT.	7028
		REPUESTO PARA SOPORTE DE TRANSMISIÓN (7028 Y 7054)	7028-9
		REPUESTO PARA SOPORTE DE MOTOR DERECHO (6942)	6950

SOPORTES TRANSMISSION & MOTOR MOUNTS



1927



1928



1973



6651



6652



6668



6913



6913-H



6938



6942



6950



7012



7012-9



7028



7028-9



CONTINUACIÓN... VOYAGER

  28		APLICACIÓN / DESCRIPTION	DAI PARTS #	SOPORTES TRANSMISSION & MOTOR MOUNTS	
SOPORTES / TRANSMISSION & MOTOR MOUNTS					
V6 3.8	01-08	SOPORTE PARA MOTOR DERECHO	7121-H		
		SOPORTE PARA MOTOR FRONTAL	7119	7054	7119
		REPUESTO PARA SOPORTE DE MOTOR FRONTAL (7119)	7119-9		
		SOPORTE PARA MOTOR TRASERO	7122	7119-9	7121-H
		SOPORTE PARA TRANSMISIÓN AUT.	7054		
V6 3.3 V6 3.8 V8 4.0	08-10	SOPORTE PARA MOTOR TRASERO	7310	7122	7279
		SOPORTE PARA MOTOR FRONTAL	7279		
		REPUESTO PARA SOPORTE DE TRANSMISIÓN (7337)	7337-9		
		SOPORTE PARA MOTOR DERECHO	7567-H	7310	7337-9
		REPUESTO PARA SOPORTE DE MOTOR FRONTAL	7716-9	7567-H	7716-9
		REPUESTO PARA SOPORTE DE MOTOR TRASERO	7723-9	7716-9	

CONTINUACIÓN... VOYAGER

 28	APLICACIÓN / DESCRIPTION	DAI PARTS #	DAI KIT PARTS #
BASES PARA AMORTIGUADOR / STRUT MOUNTS			
84-90	BASE PARA AMORTIGUADOR FRONTAL IZQUIERDA Y DERECHA	6641	6758-KIT
	BALERO PARA BASE DE AMORTIGUADOR 6641 Y 6758-KIT	6141	
84-95	BASE PARA AMORTIGUADOR FRONTAL IZQUIERDA Y DERECHA	6636	
	BASE PARA AMORTIGUADOR FRONTAL IZQUIERDA Y DERECHA	6650	6650-KIT
	BALERO PARA BASE DE AMORTIGUADOR 6636, Y 6650-KIT	6140	
96-00	BASE PARA AMORTIGUADOR FRONTAL IZQUIERDA Y DERECHA	7015	7015-KIT
01-07	BASE PARA AMORTIGUADOR FRONTAL IZQUIERDA Y DERECHA	7051	7051-KIT

BASES PARA AMORTIGUADOR STRUT MOUNTS

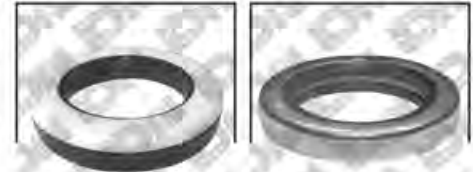

6140 6141



6636 6641



 28	APLICACIÓN / DESCRIPTION	DAI PARTS #
CUBRE POLVOS / C.V. BOOTS		
01-00	CUBRE POLVO IZQUIERDO Y DERECHO LADO CAJA	6391
	CUBRE POLVO IZQUIERDO Y DERECHO LADO RUEDA	6394

CUBRE POLVO C.V. BOOTS



6391 6394



CONTINUACIÓN... VOYAGER

	28	APLICACIÓN / DESCRIPTION	DAI PARTS #
CUBRE POLVOS / C.V. BOOTS			
01-06		CUBRE POLVO IZQUIERDO Y DERECHO LADO CAJA (TRIPOIDE)	63123
		CUBRE POLVO IZQUIERDO Y DERECHO LADO RUEDA	63124
		CUBRE POLVO DERECHO LADO CAJA	63125



MISCELÁNEOS / AUTOMOTIVE RUBBER PARTS			
84-90		GOMA PARA TIRANTE DE SUSPENSIÓN	64490
84-95		TOPE PARA AMORTIGUADOR FRONTAL IZQUIERDO Y DERECHO	D-0620
91-95		GOMA PARA BARRA ESTABILIZADORA	64717
91-99		TOPE PARA AMORTIGUADOR FRONTAL IZQUIERDO Y DERECHO	D-015
96-07		BUJE PARA HORQUILLA	DAI-1406012
		BUJE PARA HORQUILLA INFERIOR CHICO	DAI-4689120
		TORNILLO ESTABILIZADOR FRONTAL	DAI-K-7258
01-07		BUJE PARA HORQUILLA GRANDE	DAI-1406014
08-11		BUJE PARA HORQUILLA INFERIOR CHICO	DAI-1406048
		BUJE PARA HORQUILLA INFERIOR GRANDE	DAI-1406055





EAGLE
TALON

28
APLICACIÓN / DESCRIPTION
**DAI
PARTS #**
SOPORTES / TRANSMISSION & MOTOR MOUNTS

L4 2.0	95-98	OPORTE PARA MOTOR FRONTAL	7787
		SOPORTE PARA MOTOR DERECHO	7788
	95-99	SOPORTE PARA TRANSMISIÓN	7423

**SOPORTES
TRANSMISSION & MOTOR MOUNTS**

7423

7787

7788
VISION
MISCELÁNEOS / AUTOMOTIVE RUBBER PARTS

	93-97	TORNILLO ESTABILIZADOR FRONTAL	DAI-K-7197
		BUJE PARA HORQUILLA INFERIOR	DAI-K-8452-A

**MISCELÁNEOS
AUTOMOTIVE RUBBER PARTS**

DAI-K-7197

DAI-K-8452-A





FIAT

PALIO

28	APLICACIÓN / DESCRIPTION	DAI PARTS #	DAI KIT PARTS #	BASES PARA AMORTIGUADOR STRUT MOUNTS
BASES PARA AMORTIGUADOR / STRUT MOUNTS				
04-07	BASE PARA AMORTIGUADOR FRONTAL DERECHA	7342		 <p>7342</p>

ADVENTURE

BASES PARA AMORTIGUADOR / STRUT MOUNTS				BASES PARA AMORTIGUADOR STRUT MOUNTS
04-07	BASE PARA AMORTIGUADOR FRONTAL DERECHA	7342		 <p>7342</p>



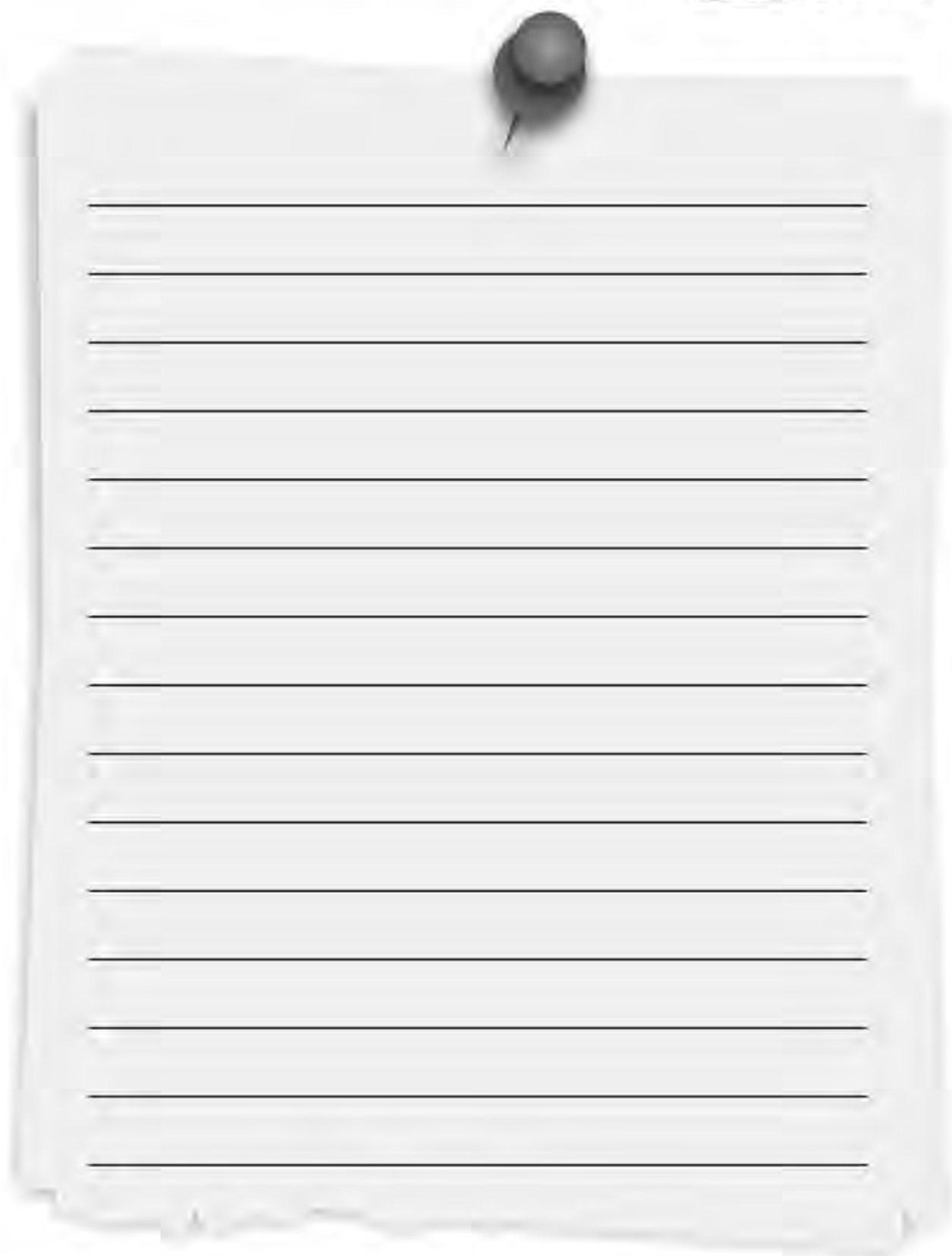

FORD
AEROSTAR

28
APLICACIÓN / DESCRIPTION
**DAI
PARTS #**
SOPORTES / TRANSMISSION & MOTOR MOUNTS

V6 3.0	86-97	SOPORTE PARA TRANSMISIÓN	6890
		SOPORTE PARA MOTOR DERECHO	6932
		SOPORTE PARA MOTOR IZQUIERDO	6933
V6 4.0	90-97	SOPORTE PARA MOTOR IZQUIERDO	6933
		SOPORTE PARA TRANSMISIÓN	6890

6933
**SOPORTES
TRANSMISSION & MOTOR MOUNTS**

6890

6932
CUBRE POLVOS / C.V. BOOTS

	86-97	CUBRE POLVO IZQUIERDO Y DERECHO LADO CAJA	6302
		CUBRE POLVO IZQUIERDO Y DERECHO DIRECCIÓN HID.	6399

**CUBRE POLVO
C.V. BOOTS**

6302



6399
MISCELÁNEOS / AUTOMOTIVE RUBBER PARTS

	86-97	TORNILLO ESTABILIZADOR (5", 1542.4 mm)	6100
		TORNILLO ESTABILIZADOR (5", 1542.4 mm EQUIPO ORIGINAL)	6104

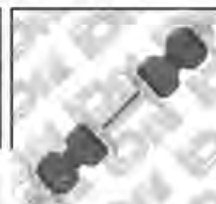
**MISCELÁNEOS
AUTOMOTIVE RUBBER PARTS**

6100

6104

BRONCO

 		APLICACIÓN / DESCRIPTION	DAI PARTS #
SOPORTES / TRANSMISSION & MOTOR MOUNTS			
L6 4.9	80-88	SOPORTE PARA TRANSMISIÓN	1798
		SOPORTE PARA MOTOR DERECHO	6870
		SOPORTE PARA MOTOR IZQUIERDO	6871
	87-93	SOPORTE PARA TRANSMISIÓN	1896
	89-93	SOPORTE PARA MOTOR IZQUIERDO Y DERECHO	6893-H
V8 5.0	68-86	SOPORTE PARA MOTOR IZQUIERDO Y DERECHO	1797
		SOPORTE PARA TRANSMISIÓN	1798
	87-93	SOPORTE PARA MOTOR IZQUIERDO Y DERECHO	1897
	87-96	SOPORTE PARA TRANSMISIÓN	1896
	94-96	SOPORTE PARA TRANSMISIÓN	1949
V8 5.8	78-79	SOPORTE PARA TRANSMISIÓN	1719
	80-86	SOPORTE PARA TRANSMISIÓN	1798
		SOPORTE PARA MOTOR IZQUIERDO Y DERECHO	1797
	87-93	SOPORTE PARA TRANSMISIÓN	1896
	87-96	SOPORTE PARA MOTOR IZQUIERDO Y DERECHO	1897
	94-95	SOPORTE PARA TRANSMISIÓN	1949
V8 6.6	78-79	SOPORTE PARA TRANSMISIÓN	1719



CONTINUACIÓN... BRONCO

 28		APLICACIÓN / DESCRIPTION	DAI PARTS #
MISCELÁNEOS / AUTOMOTIVE RUBBER PARTS			
	66-79	GOMA PARA TIRANTE DE SUSPENSIÓN (U150 4X4)	64470
	80-96	GOMA PARA TIRANTE DE SUSPENSIÓN (U150 4X4)	64370

BRONCO II

SOPORTES / TRANSMISSION & MOTOR MOUNTS			
V6 2.9	86-90	SOPORTE PARA MOTOR IZQUIERDO (4X4)	6948
		SOPORTE PARA MOTOR IZQUIERDO (4X2)	6892
		SOPORTE PARA MOTOR DERECHO	6891
		SOPORTE PARA TRANSMISIÓN	6890
		SOPORTE PARA TRANSMISIÓN	6924



MISCELÁNEOS / AUTOMOTIVE RUBBER PARTS			
	87-90	GOMA PARA TIRANTE DE SUSPENSIÓN (4X4) DANA 35	64350



CAMIONETAS

 		APLICACIÓN / DESCRIPTION	DAI PARTS #
MISCELÁNEOS / AUTOMOTIVE RUBBER PARTS			
		GOMA PARA CASETA	103
		CONJUNTO DE GOMAS TRASERAS PARA CASETA	104
		TOPE PARA SUSPENSIÓN TRASERA (DIFERENCIAL)	354
		CUBRE POLVO PARA PALANCA DE VELOCIDADES	6557
68-78		GOMA PARA BARRA ESTABILIZADORA	6409
79-85		GOMA PARA BARRA ESTABILIZADORA	6410
83-90		GOMA PARA BARRA ESTABILIZADORA	6411



CLUB WAGON

SOPORTES / TRANSMISSION & MOTOR MOUNTS			
L6 4.9	77-84	SOPORTE PARA MOTOR DERECHO	6870
		SOPORTE PARA MOTOR IZQUIERDO	6871
V6 4.2	95-06	SOPORTE PARA MOTOR DERECHO	6981
		SOPORTE PARA MOTOR IZQUIERDO	6982



CONTINUACIÓN... CLUB WAGON

	 28	APLICACIÓN / DESCRIPTION	DAI PARTS #
--	--	--------------------------	-------------

SOPORTES / TRANSMISSION & MOTOR MOUNTS

V8 4.6	97-06	SOPORTE PARA TRANSMISIÓN	1896
		SOPORTE PARA MOTOR DERECHO	7124
		SOPORTE PARA MOTOR IZQUIERDO	7125

V8 5.0	68-74	SOPORTE PARA MOTOR IZQUIERDO Y DERECHO	1797
		SOPORTE PARA TRANSMISIÓN	1719
	75-91	SOPORTE PARA TRANSMISIÓN	1798
	92-96	SOPORTE PARA TRANSMISIÓN	1896

V8 5.4	97-06	SOPORTE PARA MOTOR DERECHO	7124
		SOPORTE PARA MOTOR IZQUIERDO	7125

V8 5.8	75-91	SOPORTE PARA TRANSMISIÓN	1798
	75-96	SOPORTE PARA MOTOR DERECHO	6868
		SOPORTE PARA MOTOR IZQUIERDO	6869
	92-96	SOPORTE PARA TRANSMISIÓN	1896

7124
7125
**SOPORTES
TRANSMISSION & MOTOR MOUNTS**

1719

1797

1798

1896

6868

6869
MISCELÁNEOS / AUTOMOTIVE RUBBER PARTS

	71-72	GOMA PARA TIRANTE DE SUSPENSIÓN	64450
--	-------	---------------------------------	-------

**MISCELÁNEOS
AUTOMOTIVE RUBBER PARTS**

64450

CONTOUR

 		APLICACIÓN / DESCRIPTION	DAI PARTS #
SOPORTES / TRANSMISSION & MOTOR MOUNTS			
L4 2.0	95-00	REPUESTO PARA SOPORTE DE MOTOR FRONTAL (6704)	6704-9
		REPUESTO PARA SOPORTE DE MOTOR FRONTAL (6705)	6705-9
		SOPORTE PARA TRANSMISIÓN AUT.	6706
		SOPORTE PARA TRANSMISIÓN STD.	6707
		REPUESTO PARA SOPORTE DE TRANSMISIÓN STD. Y AUT. (6706, 6707, 6940 Y 6941)	6707-9
		SOPORTE PARA MOTOR TRASERO	6714
		REPUESTO PARA SOPORTE MOTOR TRASERO (6714)	6714-9
		SOPORTE PARA TRANSMISIÓN	6940
		REPUESTO PARA SOPORTE DE TRANSMISIÓN	6941
		SOPORTE PARA MOTOR FRONTAL STD. (TIPO ORIGINAL)	6856
		SOPORTE PARA MOTOR FRONTAL AUT. (TIPO ORIGINAL)	6857
L4 2.4 V6 2.5	95-01	REPUESTO PARA SOPORTE DE MOTOR FRONTAL (6704)	6704-9
		SOPORTE PARA MOTOR DERECHO	6703
		REPUESTO PARA SOPORTE DE MOTOR FRONTAL (6705)	6705-9
		REPUESTO PARA SOPORTE DE TRANSMISIÓN STD. Y AUT. (6706, 6707, 6940 Y 6941)	6707-9
		SOPORTE PARA MOTOR TRASERO	6714
		REPUESTO PARA SOPORTE MOTOR TRASERO (6714)	6714-9



CONTINUACIÓN... CONTOUR

 		APLICACIÓN / DESCRIPTION	DAI PARTS #
SOPORTES / TRANSMISSION & MOTOR MOUNTS			
L4 2.4 V6 2.5	95-01	SÓPORTE PARA TRANSMISIÓN	6940
L4 2.4	95-01	SOPORTE PARA TRANSMISIÓN AUT.	6706
		SOPORTE PARA MOTOR FRONTAL STD. (TIPO ORIGINAL)	6856
		SOPORTE PARA MOTOR FRONTAL AUT. (TIPO ORIGINAL)	6857
V6 2.5	95-00	SOPORTE PARA TRANSMISIÓN AUT.	6706
		SOPORTE PARA TRANSMISIÓN STD.	6707
		REPUESTO PARA SOPORTE DE TRANSMISIÓN	6941
	95-01	SOPORTE PARA MOTOR FRONTAL	6939



		APLICACIÓN / DESCRIPTION	DAI PARTS #	DAI KIT PARTS #
BASES PARA AMORTIGUADOR / STRUT MOUNTS				
95-01		BASE PARA AMORTIGUADOR FRONTAL IZQUIERDA Y DERECHA	6753	6753-KIT



CONTINUACIÓN... CONTOUR

28		APLICACIÓN / DESCRIPTION	DAI PARTS #	DAI KIT PARTS #
BASES PARA AMORTIGUADOR / STRUT MOUNTS				
95-01		BASE PARA AMORTIGUADOR TRASERA IZQUIERDA Y DERECHA	6754	6754-KIT



28		APLICACIÓN / DESCRIPTION	DAI PARTS #
MISCELÁNEOS / AUTOMOTIVE RUBBER PARTS			
95-01		GOMA PARA CREMALLERA DE DIRECCIÓN HID., (DERECHA PAR 720)	719
		GOMA PARA CREMALLERA DE DIRECCIÓN HID., (IZQUIERDA PAR 719)	720
		TORNILLO ESTABILIZADOR FRONTAL	DAI-93BB-3B-438CA



DAI-93BB-3B-438CA

COUGAR

SOPORTES / TRANSMISSION & MOTOR MOUNTS			
L6 3.3	80-82	SOPORTE PARA TRANSMISIÓN AUT.	1845
		SOPORTE PARA TRANSMISIÓN STD.	1846



CONTINUACIÓN... COUGAR

 		APLICACIÓN / DESCRIPTION	DAI PARTS #
SOPORTES / TRANSMISSION & MOTOR MOUNTS			
V6 3.8	85-97	SOPORTE PARA TRANSMISIÓN AUT.	1845
		SOPORTE PARA TRANSMISIÓN STD.	1846
		SOPORTE PARA MOTOR IZQUIERDO Y DERECHO	1881-H
		SOPORTE PARA MOTOR IZQUIERDO	6623
		SOPORTE PARA MOTOR DERECHO	6624
		SOPORTE PARA TRANSMISIÓN AUT.	6828
V8 5.0	87-97	SOPORTE PARA TRANSMISIÓN AUT.	1845
		SOPORTE PARA MOTOR IZQUIERDO Y DERECHO	1881-H
		SOPORTE PARA TRANSMISIÓN AUT.	6828

**SOPORTES
TRANSMISSION & MOTOR MOUNTS**

1845

1846

1881-H

6623

6624

6828

	APLICACIÓN / DESCRIPTION	DAI PARTS #	DAI KIT PARTS #
BASES PARA AMORTIGUADOR / STRUT MOUNTS			
80-86	BASE PARA AMORTIGUADOR FRONTAL IZQUIERDA Y DERECHA	6742	6742-KIT

**BASES PARA AMORTIGUADOR
STRUT MOUNTS**

6742

6742-KIT

CONTINUACIÓN... COUGAR

28	APLICACIÓN / DESCRIPTION	DAI PARTS #	DAI KIT PARTS #
BASES PARA AMORTIGUADOR / STRUT MOUNTS			
80-01	BASE PARA AMORTIGUADOR FRONTAL IZQUIERDA Y DERECHA	1829	1829-KIT
	REPUESTO PARA BASE DE AMORTIGUADOR FRONTAL IZQUIERDA Y DERECHA 6741, 6741-KIT, 6142 Y 6142-KIT		6729-KIT
87-89	BASE PARA AMORTIGUADOR FRONTAL IZQUIERDA Y DERECHA	6741	6741-KIT
90-97	BASE PARA AMORTIGUADOR FRONTAL IZQUIERDA Y DERECHA	6740	6740-KIT

BASES PARA AMORTIGUADOR STRUT MOUNTS

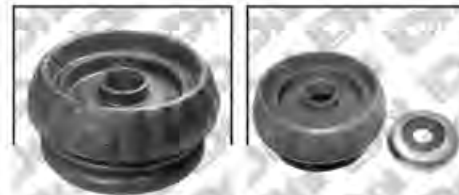

1829 1829-KIT



6729-KIT 6740



6740-KIT 6741 6741-KIT

28	APLICACIÓN / DESCRIPTION	DAI PARTS #
CUBRE POLVOS / C.V. BOOTS		
87-89	CUBRE POLVO IZQUIERDO Y DERECHO DE DIRECCIÓN HID.	6342
	CUBRE POLVO IZQUIERDO Y DERECHO LADO RUEDA	6378
90-97	CUBRE POLVO IZQUIERDO Y DERECHO LADO CAJA	6380
	CUBRE POLVO IZQUIERDO Y DERECHO DE DIRECCIÓN HID.	6361

CUBRE POLVO C.V. BOOTS

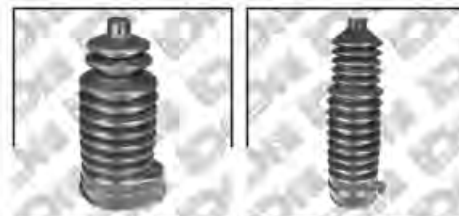

6342 6361



6378 6380



CONTINUACIÓN... COUGAR

		28	APLICACIÓN / DESCRIPTION	DAI PARTS #
MISCELÁNEOS / AUTOMOTIVE RUBBER PARTS				
80-86			TORNILLO ESTABILIZADOR (7", 203.2 mm)	6102
			TORNILLO ESTABILIZADOR (7", 203.2 mm EQUIPO ORIGINAL)	6106
80-96			GOMA SUJETADORA DE ESCAPE	72
87-89			TORNILLO ESTABILIZADOR (10", 254.0 mm)	6103
90-97			TOPE PARA AMORTIGUADOR FRONTAL IZQUIERDO Y DERECHO	D-0620
			TOPE PARA AMORTIGUADOR FRONTAL Y TRASERO IZQUIERDO Y DERECHO	D-0621
			TORNILLO EXCENTRICO	64600
99-02			TORNILLO ESTABILIZADOR FRONTAL	DAI-93BB-3B-438CA

**MISCELÁNEOS
AUTOMOTIVE RUBBER PARTS**

D-0620

D-0621

72

6102

6103

6106

64600

DAI-93BB-3B-438CA
COUNTRY SQUIRE
MISCELÁNEOS / AUTOMOTIVE RUBBER PARTS

65-78	GOMA PARA TIRANTE DE SUSPENSIÓN	64430
-------	---------------------------------	-------

**MISCELÁNEOS
AUTOMOTIVE RUBBER PARTS**

64430



COURIER

 		APLICACIÓN / DESCRIPTION	DAI PARTS #
SOPORTES / TRANSMISSION & MOTOR MOUNTS			
L4 1.6	00-12	SOPORTE DE TORSIÓN TRASERO	6989
		SOPORTE PARA TRANSMISIÓN	6990
		REPUESTO PARA SOPORTE DE TRANSMISIÓN 6990	6990-9
		SOPORTE PARA MOTOR DERECHO	7013



		APLICACIÓN / DESCRIPTION	DAI PARTS #	DAI KIT PARTS #
BASES PARA AMORTIGUADOR / STRUT MOUNTS				
00-12		BASE PARA AMORTIGUADOR FRONTAL IZQUIERDA Y DERECHA	1829	1829-KIT
		BALERO PARA BASE DE AMORTIGUADOR FRONTAL IZQ. Y DER., (1829)	6146	



 		APLICACIÓN / DESCRIPTION	DAI PARTS #
CUBRE POLVOS / C.V. BOOTS			
	00-12	CUBRE POLVO IZQUIERDO Y DERECHO LADO RUEDA	6315
		CUBRE POLVO IZQUIERDO Y DERECHO LADO RUEDA	6316



CONTINUACIÓN... COURIER

28		APLICACIÓN / DESCRIPTION	DAI PARTS #
CUBRE POLVOS / C.V. BOOTS			
00-12	CUBRE POLVO IZQUIERDO Y DERECHO LADO CAJA (CON TRIPOIDE)		6319
	CUBRE POLVO IZQUIERDO LADO CAJA		6327
	CUBRE POLVO DERECHO LADO CAJA (CON TRIPOIDE)		6386



MISCELÁNEOS / AUTOMOTIVE RUBBER PARTS			
81-90	BUJE PARA HORQUILLA (BRAZO) INFERIOR EXTERIOR (ZX2)		DAI-K-8417
	BUJE PARA HORQUILLA (BRAZO) INFERIOR INTERIOR (ZX2)		DAI-K-8436
91-02	TOPE PARA AMORTIGUADOR TRASERO IZQUIERDO Y DERECHO		D-050
	TOPE PARA AMORTIGUADOR TRASERO IZQUIERDO Y DERECHO (ZX2)		
	TOPE PARA AMORTIGUADOR TRASERO IZQUIERDO Y DERECHO		D-074



CROWN VICTORIA

  28		APLICACIÓN / DESCRIPTION	DAI PARTS #
SOPORTES / TRANSMISSION & MOTOR MOUNTS			
V8 4.6	92-97	SOPORTE PARA MOTOR IZQUIERDO	6702
		SOPORTE PARA MOTOR DERECHO	6701
		SOPORTE PARA TRANSMISIÓN	6622
V8 5.0 V8 5.8	87-91	SOPORTE PARA MOTOR IZQUIERDO	6620
		SOPORTE PARA MOTOR DERECHO	6621
		SOPORTE PARA TRANSMISIÓN	6622



MISCELÁNEOS / AUTOMOTIVE RUBBER PARTS			
	83-86	TORNILLO ESTABILIZADOR (10", 254.0 mm)	6103
	92-02	TORNILLO ESTABILIZADOR 10" (243 mm EQUIPO ORIGINAL)	6107
	95-02	TORNILLO ESTABILIZADOR FRONTAL	DAI-K-8953



E-100

 		APLICACIÓN / DESCRIPTION	DAI PARTS #
SOPORTES / TRANSMISSION & MOTOR MOUNTS			
L6 4.9	77-84	SOPORTE PARA MOTOR DERECHO	6870
		SOPORTE PARA MOTOR IZQUIERDO	6871
V8 4.6	97-06	SOPORTE PARA TRANSMISIÓN	1896
V8 5.0	68-74	SOPORTE PARA TRANSMISIÓN	1719
		SOPORTE PARA MOTOR IZQUIERDO Y DERECHO	1797
	75-91	SOPORTE PARA TRANSMISIÓN	1798
	92-96	SOPORTE PARA TRANSMISIÓN	1896
V8 5.8	75-96	SOPORTE PARA MOTOR DERECHO	6868
		SOPORTE PARA MOTOR IZQUIERDO	6869
	75-91	SOPORTE PARA TRANSMISIÓN	1798
	92-96	SOPORTE PARA TRANSMISIÓN	1896

**SOPORTES
TRANSMISSION & MOTOR MOUNTS**

1719

1797

1798

1896

6868

6869

6870

6871
MISCELÁNEOS / AUTOMOTIVE RUBBER PARTS

69-87	GOMA PARA TIRANTE DE SUSPENSIÓN VAM	64470
71-72	GOMA PARA TIRANTE DE SUSPENSIÓN	64450

**MISCELÁNEOS
AUTOMOTIVE RUBBER PARTS**

64450

64470

CONTINUACIÓN... E-100

	 28	APLICACIÓN / DESCRIPTION	DAI PARTS #
MISCELÁNEOS / AUTOMOTIVE RUBBER PARTS			
	75-91	BUJE PARA EJE (PARALELO) VAM	DAI-K-8300

**MISCELÁNEOS
AUTOMOTIVE RUBBER PARTS**



DAI-K-8300

E-150

SOPORTES / TRANSMISSION & MOTOR MOUNTS			
L6 4.9	77-84	SOPORTE PARA MOTOR DERECHO	6870
		SOPORTE PARA MOTOR IZQUIERDO	6871
V8 4.2	97-03	SOPORTE PARA TRANSMISIÓN	1896
		SOPORTE PARA MOTOR DERECHO	6981
		SOPORTE PARA MOTOR IZQUIERDO	6982
V8 4.6	97-06	SOPORTE PARA TRANSMISIÓN	1896
		SOPORTE PARA MOTOR DERECHO	7124
		SOPORTE PARA MOTOR IZQUIERDO	7125
V8 5.4	97-06	SOPORTE PARA MOTOR DERECHO	7124
		SOPORTE PARA MOTOR IZQUIERDO	7125
V8 5.0	68-74	SOPORTE PARA TRANSMISIÓN	1719
		SOPORTE PARA MOTOR IZQUIERDO Y DERECHO	1797

**SOPORTES
TRANSMISSION & MOTOR MOUNTS**



1797



1896



6870



6871



6981



6982



7124



7125



CONTINUACIÓN... E-150

		APLICACIÓN / DESCRIPTION	DAI PARTS #
SOPORTES / TRANSMISSION & MOTOR MOUNTS			
V8 5.0	75-91	SOPORTE PARA TRANSMISIÓN	1798
	92-96	SOPORTE PARA TRANSMISIÓN	1896
V8 5.8	75-91	SOPORTE PARA TRANSMISIÓN	1798
	75-96	SOPORTE PARA MOTOR DERECHO	6868
		SOPORTE PARA MOTOR IZQUIERDO	6869
	92-96	SOPORTE PARA TRANSMISIÓN	1896



MISCELÁNEOS / AUTOMOTIVE RUBBER PARTS			
	71-72	GOMA PARA TIRANTE DE SUSPENSIÓN	64450
	75-87	GOMA PARA TIRANTE DE SUSPENSIÓN VAM	64470
	75-91	BUJE PARA EJE (PARALELO) VAM	DAI-K-8300
	92-07	BUJE PARA TIRANTE	DAI-K-8645

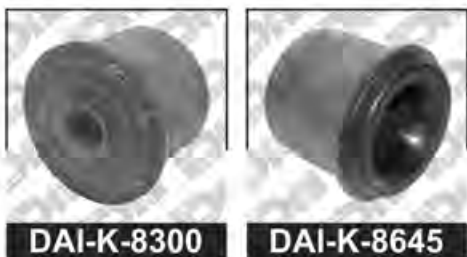

E-200

 		APLICACIÓN / DESCRIPTION	DAI PARTS #
MISCELÁNEOS / AUTOMOTIVE RUBBER PARTS			
	69-74	GOMA PARA TIRANTE DE SUSPENSIÓN VAN	64470
	71-72	GOMA PARA TIRANTE DE SUSPENSIÓN	64450



E-250

SOPORTES / TRANSMISSION & MOTOR MOUNTS			
L6 4.9	77-84	SOPORTE PARA MOTOR DERECHO	6870
		SOPORTE PARA MOTOR IZQUIERDO	6871
V8 4.2	97-03	SOPORTE PARA TRANSMISIÓN	1896
		SOPORTE PARA MOTOR DERECHO	6981
		SOPORTE PARA MOTOR IZQUIERDO	6982
V8 4.6	97-06	SOPORTE PARA TRANSMISIÓN	1896
V8 4.6 V8 5.4	97-06	SOPORTE PARA MOTOR DERECHO	7124
		SOPORTE PARA MOTOR IZQUIERDO	7125
V8 5.0	68-74	SOPORTE PARA TRANSMISIÓN	1719
		SOPORTE PARA MOTOR IZQUIERDO Y DERECHO	1797
	75-91	SOPORTE PARA TRANSMISIÓN	1798
	92-96	SOPORTE PARA TRANSMISIÓN	1896

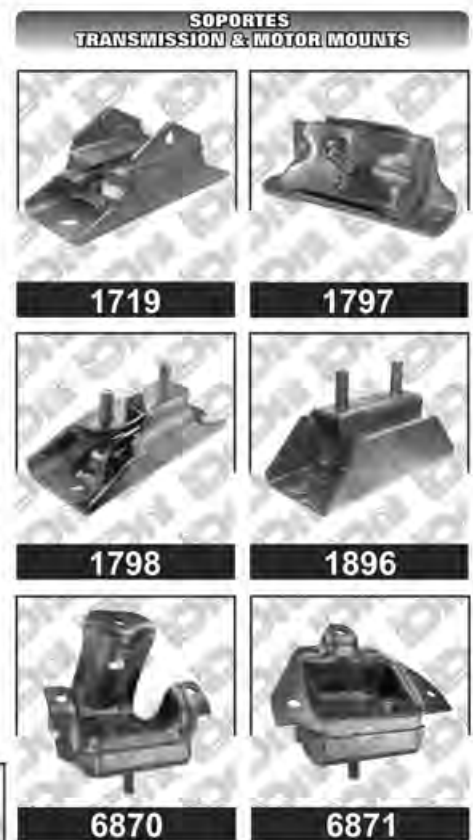

CONTINUACIÓN... E-250

  28		APLICACIÓN / DESCRIPTION	DAI PARTS #
SOPORTES / TRANSMISSION & MOTOR MOUNTS			
V8 5.8	75-91	SOPORTE PARA TRANSMISIÓN	1798
	75-96	SOPORTE PARA MOTOR DERECHO	6868
		SOPORTE PARA MOTOR IZQUIERDO	6869
	92-96	SOPORTE PARA TRANSMISIÓN	1896



MISCELÁNEOS / AUTOMOTIVE RUBBER PARTS			
	71-72	GOMA PARA TIRANTE DE SUSPENSIÓN	64450
	75-01	BUJE PARA EJE (PARALELO) VAM	DAI-K-8300
	92-07	BUJE PARA TIRANTE	DAI-K-8645

E-300

SOPORTES / TRANSMISSION & MOTOR MOUNTS			
L6 4.9	77-84	SOPORTE PARA MOTOR DERECHO	6870
		SOPORTE PARA MOTOR IZQUIERDO	6871



CONTINUACIÓN... E-300

		APLICACIÓN / DESCRIPTION	DAI PARTS #
---	---	---------------------------------	--------------------

SOPORTES / TRANSMISSION & MOTOR MOUNTS

V8 4.6	97-06	SOPORTE PARA MOTOR IZQUIERDO	7125
		SOPORTE PARA MOTOR DERECHO	7124
		SOPORTE PARA TRANSMISIÓN	1896
V8 5.0	68-74	SOPORTE PARA MOTOR IZQUIERDO Y DERECHO	1797
		SOPORTE PARA TRANSMISIÓN	1719
	75-91	SOPORTE PARA TRANSMISIÓN	1798
	92-96	SOPORTE PARA TRANSMISIÓN	1896
V8 5.4	97-06	SOPORTE PARA MOTOR IZQUIERDO	7125
		SOPORTE PARA MOTOR DERECHO	7124
V8 5.8	75-96	SOPORTE PARA MOTOR DERECHO	6868
		SOPORTE PARA MOTOR IZQUIERDO	6869
	75-91	SOPORTE PARA TRANSMISIÓN	1798
	92-96	SOPORTE PARA TRANSMISIÓN	1896

**SOPORTES
TRANSMISSION & MOTOR MOUNTS**



1719



1797



1798



1896



6868



6869



7124



7125

MISCELÁNEOS / AUTOMOTIVE RUBBER PARTS

69-74	GOMA PARA TIRANTE DE SUSPENSIÓN VAN	64470
-------	-------------------------------------	-------

**MISCELÁNEOS
AUTOMOTIVE RUBBER PARTS**



64470



E-350

 		APLICACIÓN / DESCRIPTION	DAI PARTS #
SOPORTES / TRANSMISSION & MOTOR MOUNTS			
L6 4.9	77-84	SOPORTE PARA MOTOR DERECHO	6870
		SOPORTE PARA MOTOR IZQUIERDO	6871
V8 4.6	97-06	SOPORTE PARA TRANSMISIÓN	1896
		SOPORTE PARA MOTOR IZQUIERDO	7124
		SOPORTE PARA MOTOR DERECHO	7125
V8 5.0	68-74	SOPORTE PARA TRANSMISIÓN	1719
		SOPORTE PARA MOTOR IZQUIERDO Y DERECHO	1797
	75-91	SOPORTE PARA TRANSMISIÓN	1798
	92-96	SOPORTE PARA TRANSMISIÓN	1896
V8 5.4	99-03	SOPORTE PARA MOTOR IZQUIERDO (TRITON)	7115
		SOPORTE PARA MOTOR DERECHO (TRITON)	7116
	97-06	SOPORTE PARA MOTOR IZQUIERDO	7124
		SOPORTE PARA MOTOR DERECHO	7125
		SOPORTE PARA TRANSMISIÓN	1896
V8 5.8	75-91	SOPORTE PARA TRANSMISIÓN	1798
	75-96	SOPORTE PARA MOTOR DERECHO	6868
		SOPORTE PARA MOTOR IZQUIERDO	6869
	92-96	SOPORTE PARA TRANSMISIÓN	1896

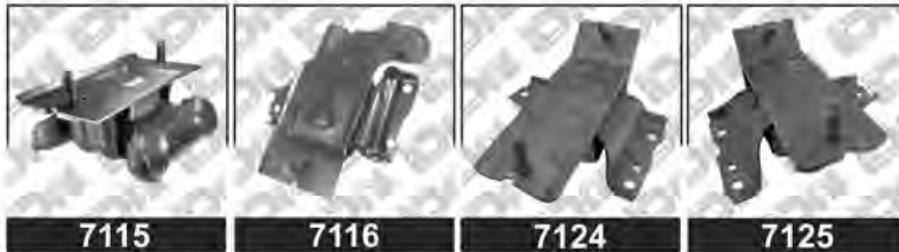

CONTINUACIÓN... E-350

 		APLICACIÓN / DESCRIPTION	DAI PARTS #
MISCELÁNEOS / AUTOMOTIVE RUBBER PARTS			
	75-01	BUJE PARA EJE (PARALELO) VAN	DAI-K-8300
	92-06	BUJE PARA TIRANTE	DAI-K-8645

**MISCELÁNEOS
AUTOMOTIVE RUBBER PARTS**



DAI-K-8300



DAI-K-8645

E-450

SOPORTES / TRANSMISSION & MOTOR MOUNTS			
		SOPORTE PARA TRANSMISIÓN	1896
V8 5.4	97-06	SOPORTE PARA MOTOR IZQUIERDO	7125
		SOPORTE PARA MOTOR DERECHO	7124



7125

**SOPORTES
TRANSMISSION & MOTOR MOUNTS**



1896



7124

MISCELÁNEOS / AUTOMOTIVE RUBBER PARTS			
	92-07	BUJE PARA TIRANTE	DAI-K-8645

**MISCELÁNEOS
AUTOMOTIVE RUBBER PARTS**



DAI-K-8645



E-550

  28		APLICACIÓN / DESCRIPTION	DAI PARTS #
MISCELÁNEOS / AUTOMOTIVE RUBBER PARTS			
92-07		BUJE PARA TIRANTE	DAI-K-8645

**MISCELÁNEOS
AUTOMOTIVE RUBBER PARTS**

DAI-K-8645
ECOSPORT
SOPORTES / TRANSMISSION & MOTOR MOUNTS

L4 2.0	04-12	SOPORTE PARA MOTOR TRASERO TORQUE STRUT AUT.	7753
		SOPORTE PARA TRANSMISIÓN	7082
		SOPORTE PARA MOTOR DERECHO	7210
		SOPORTE PARA MOTOR TRASERO STD.	7481

**SOPORTES
TRANSMISSION & MOTOR MOUNTS**

7082

7210

7481

7753



 28		APLICACIÓN / DESCRIPTION	DAI PARTS #	DAI KIT PARTS #
BASES PARA AMORTIGUADOR / STRUT MOUNTS				
04-12		BASE PARA AMORTIGUADOR TRASERA IZQUIERDA Y DERECHA	7353	
		BASE PARA AMORTIGUADOR FRONTAL IZQUIERDA Y DERECHA		7384-KIT

**BASES PARA AMORTIGUADOR
STRUT MOUNTS**

7353

7384-KIT

CONTINUACIÓN... ECOSPORT

  28		APLICACIÓN / DESCRIPTION	DAI PARTS #
CUBRE POLVOS / C.V. BOOTS			
04-12		CUBRE POLVO IZQUIERDO Y DERECHO LADO CAJA (CON TRIPOIDE)	6308
		CUBRE POLVO IZQUIERDO Y DERECHO DE DIRECCIÓN HID.	63112



MISCELÁNEOS / AUTOMOTIVE RUBBER PARTS			
03-12		TORNILLO ESTABILIZADOR	DAI-2108002
04-12		BUJE PARA HORQUILLA INFERIOR GRANDE (SIN SOPORTE)	DAI-1408016
		BUJE PARA HORQUILLA INFERIOR CHICO	DAI-1408017



ECONOLINE

SOPORTES / TRANSMISSION & MOTOR MOUNTS			
L6 4.9	77-84	SOPORTE PARA MOTOR DERECHO	6870
		SOPORTE PARA MOTOR IZQUIERDO (E-250)	6871



CONTINUACIÓN... ECONOLINE

	28	APLICACIÓN / DESCRIPTION	DAI PARTS #
SOPORTES / TRANSMISSION & MOTOR MOUNTS			
V8 4.2	93-11	SOPORTE PARA TRANSMISIÓN	1896
		SOPORTE PARA MOTOR DERECHO	6981
		SOPORTE PARA MOTOR IZQUIERDO	6982

V8 4.6	97-06	SOPORTE PARA TRANSMISIÓN	1896
		SOPORTE PARA MOTOR DERECHO	7124
		SOPORTE PARA MOTOR IZQUIERDO	7125
	06-10	SOPORTE PARA MOTOR IZQUIERDO <i>(CLUB WAGON E-250)</i>	7580-H
		SOPORTE PARA MOTOR DERECHO <i>(CLUB WAGON E-250)</i>	7601-H

V8 5.0	68-74	SOPORTE PARA TRANSMISIÓN	1719
		SOPORTE PARA MOTOR IZQUIERDO Y DERECHO	1797
	75-91	SOPORTE PARA TRANSMISIÓN	1798
	92-96	SOPORTE PARA TRANSMISIÓN	1896

V8 5.4	93-11	SOPORTE PARA MOTOR DERECHO (TRITON)	7115
		SOPORTE PARA MOTOR IZQUIERDO (TRITON)	7116
		SOPORTE PARA MOTOR DERECHO <i>SUPER DUTY</i>	7124
		SOPORTE PARA MOTOR IZQUIERDO <i>SUPER DUTY</i>	7125
		SOPORTE PARA TRANSMISIÓN	1896
	05-10	SOPORTE PARA MOTOR DERECHO <i>(CLUB WAGON E-250)</i>	7601-H
	06-10	SOPORTE PARA MOTOR IZQUIERDO <i>(CLUB WAGON E-250)</i>	7580-H

**SOPORTES
TRANSMISSION & MOTOR MOUNTS**

1719

1797

1798

1896

6981

6982

7115

7116

7124

7125

7580-H

7601-H

CONTINUACIÓN... ECONOLINE

		APLICACIÓN / DESCRIPTION	DAI PARTS #
---	---	--------------------------	-------------

SOPORTES / TRANSMISSION & MOTOR MOUNTS

V8 5.8	75-91	SOPORTE PARA TRANSMISIÓN	1798
	75-96	SOPORTE PARA MOTOR DERECHO	6868
		SOPORTE PARA MOTOR IZQUIERDO	6869
	92-96	SOPORTE PARA TRANSMISIÓN	1896
V8 7.5	75-80	SOPORTE PARA MOTOR IZQUIERDO Y DERECHO (E-250)	6871
	75-96	SOPORTE PARA MOTOR IZQUIERDO Y DERECHO (E-350)	
	76-80	SOPORTE PARA MOTOR IZQUIERDO Y DERECHO (E-150)	
	81-91	SOPORTE PARA MOTOR IZQUIERDO Y DERECHO (E-250 CLUB WAGON)	

**SOPORTES
TRANSMISSION & MOTOR MOUNTS**



1798



1896



6868



6869



6871

MISCELÁNEOS / AUTOMOTIVE RUBBER PARTS

71-72	GOMA PARA TIRANTE DE SUSPENSIÓN	64450
-------	---------------------------------	-------

**MISCELÁNEOS
AUTOMOTIVE RUBBER PARTS**



64450



EDGE

  28		APLICACIÓN / DESCRIPTION	DAI PARTS #
SOPORTES / TRANSMISSION & MOTOR MOUNTS			
L4 2.0	15-17	SOPORTE PARA TRANSMISIÓN	7766
V6 3.5	06-14	SOPORTE PARA MOTOR TRASERO	7558
V6 3.7			





MISCELÁNEOS / AUTOMOTIVE RUBBER PARTS		
	07-14	BUJES PARA HORQUILLA TRASERA (2 PIEZAS) DAI-1508086

ESCAPE

SOPORTES / TRANSMISSION & MOTOR MOUNTS			
L4 1.6	13-16	SOPORTE PARA MOTOR TRASERO	7617
		SOPORTE PARA TRANSMISIÓN	7689
	13-17	SOPORTE PARA MOTOR TRASERO REFORZADO	7759
L4 2.0	01-05	SOPORTE PARA MOTOR TRASERO	7117
		SOPORTE PARA TRANSMISIÓN AUT. TRACCIÓN DELANTERA Y (4X4)	7118



CONTINUACIÓN... ESCAPE

			APLICACIÓN / DESCRIPTION	DAI PARTS #
SOPORTES / TRANSMISSION & MOTOR MOUNTS				
L4 2.0	01-05	SOPORTE PARA MOTOR DERECHO TRACCIÓN DELANTERA Y (4X4)		7237-H
	13-16	SOPORTE PARA TRANSMISIÓN		7689
		SOPORTE PARA MOTOR TRASERO		7617
	13-17	SOPORTE PARA MOTOR TRASERO REFORZADO		7759
L4 2.3	01-05	SOPORTE PARA MOTOR TRASERO		7117
		SOPORTE PARA TRANSMISIÓN AUT.		7118
		SOPORTE PARA MOTOR DERECHO		7237-H
	06-13	SOPORTE PARA MOTOR FRONTAL		7281
		SOPORTE PARA MOTOR TRASERO		7282
		SOPORTE PARA MOTOR DERECHO		7339-H
		SOPORTE PARA TRANSMISIÓN		7340
L4 2.5	13-16	SOPORTE PARA MOTOR TRASERO		7617
		SOPORTE PARA TRANSMISIÓN		7689
	13-17	SOPORTE PARA MOTOR TRASERO REFORZADO		7759
V6 3.0	01-12	SOPORTE PARA MOTOR TRASERO		7117
		SOPORTE PARA TRANSMISIÓN AUT.		7118
		SOPORTE PARA MOTOR DERECHO		7237-H



CONTINUACIÓN... ESCAPE

28		APLICACIÓN / DESCRIPTION	DAI PARTS #	DAI KIT PARTS #
BASES PARA AMORTIGUADOR / STRUT MOUNTS				
01-13		BASE PARA AMORTIGUADOR FRONTAL IZQUIERDA Y DERECHA		7299-KIT
13-15		BASE PARA AMORTIGUADOR FRONTAL IZQUIERDA Y DERECHA	7182	





28		APLICACIÓN / DESCRIPTION	DAI PARTS #
MISCELÁNEOS / AUTOMOTIVE RUBBER PARTS			
01-12		BUJE PARA HORQUILLA INFERIOR GRANDE	DAI-1408007
		BUJE PARA HORQUILLA INFERIOR CHICO	DAI-1408063
01-12		TORNILLO ESTABILIZADOR FRONTAL (LARGO)	DAI-2108002
01-04		TORNILLO ESTABILIZADOR FRONTAL	DAI-2108004



ESCORT

SOPORTES / TRANSMISSION & MOTOR MOUNTS			
L4 1.8 L4 1.9	91-96	SOPORTE PARA MOTOR FRONTAL	6835
		REPUESTO PARA SOPORTE DE MOTOR FRONTAL (6835)	6835-9

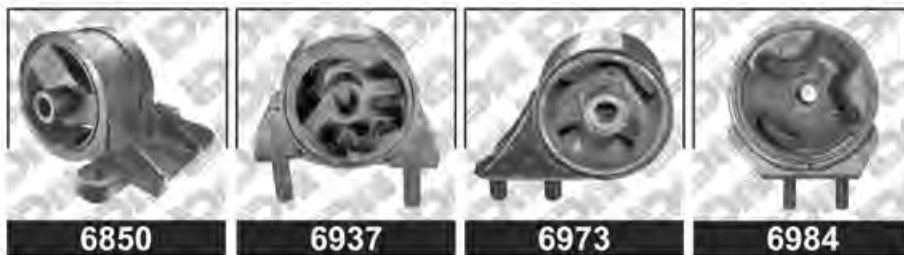
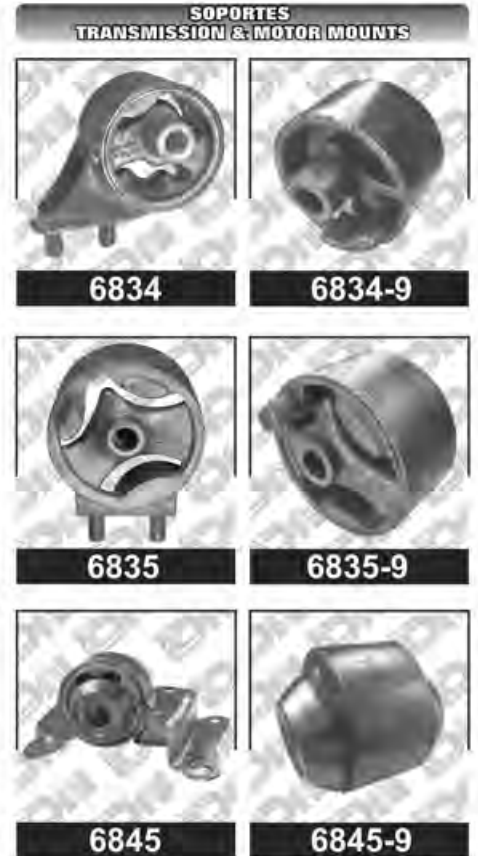

CONTINUACIÓN... ESCORT

		 28	APLICACIÓN / DESCRIPTION	DAI PARTS #
SOPORTES / TRANSMISSION & MOTOR MOUNTS				
L4 1.8	91-96		SOPORTE PARA MOTOR TRASERO (TIPO ORIGINAL)	6973
L4 1.8 L4 1.9	91-96		SOPORTE PARA MOTOR DERECHO	6850
			SOPORTE PARA TRANSMISIÓN	6845
			REPUESTO PARA SOPORTE DE TRANSMISIÓN (6845)	6845-9
			SOPORTE PARA TRANSMISIÓN TRASERO	6834
			REPUESTO PARA SOPORTE DE TRANSMISIÓN TRASERO (6834 Y 6973)	6834-9
			SOPORTE PARA MOTOR FRONTAL AUT.	6984
L4 2.0	97-03		SOPORTE PARA MOTOR FRONTAL	6835
			REPUESTO PARA SOPORTE DE MOTOR FRONTAL (6835)	6835-9
			SOPORTE PARA MOTOR DERECHO	6850
			REPUESTO PARA SOPORTE DE TRANSMISIÓN TRASERO (6845)	6845-9
			SOPORTE PARA TRANSMISIÓN	6937
			SOPORTE PARA MOTOR FRONTAL AUT.	6984



CONTINUACIÓN... ESCORT

28		APLICACIÓN / DESCRIPTION	DAI PARTS #	DAI KIT PARTS #
BASES PARA AMORTIGUADOR / STRUT MOUNTS				
81-90	BASE PARA AMORTIGUADOR FRONTAL IZQUIERDA Y DERECHA (ZX2)	1855		
	BASE PARA AMORTIGUADOR FRONTAL IZQUIERDA Y DERECHA (ZX2)	6784	6784-KIT	
	BALERO PARA BASES DE AMORTIGUADOR 1855, 6784 Y 6784-KIT (Zx2)	6138		
81-03	BASE PARA AMORTIGUADOR FRONTAL IZQUIERDA Y DERECHA	1855		
	BALERO PARA BASES DE AMORTIGUADOR 1855, 6784 Y 6784-KIT	6138		
	BASE PARA AMORTIGUADOR TRASERA IZQUIERDA Y DERECHA		6734-KIT	
	BASE PARA AMORTIGUADOR FRONTAL IZQUIERDA Y DERECHA	6784	6784-KIT	
91-02	BASE PARA AMORTIGUADOR TRASERA IZQUIERDA Y DERECHA (ZX2)	6737	6737-KIT	
	BALERO PARA BASE DE AMORTIGUADOR FRONTAL IZQUIERDA Y DERECHA 7029 (ZX2)	6148		
	BASE PARA AMORTIGUADOR FRONTAL IZQUIERDA Y DERECHA (ZX2)	7029	7029-KIT	

BASES PARA AMORTIGUADOR STRUT MOUNTS

1855

6138

6148

6734-KIT

6737

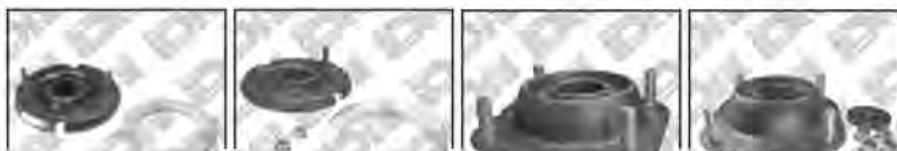

6737-KIT

6784
6784-KIT
7029
7029-KIT

28		APLICACIÓN / DESCRIPTION	DAI PARTS #
CUBRE POLVOS / C.V. BOOTS			
91-02	CUBRE POLVO IZQUIERDO Y DERECHO LADO RUEDA (ZX2)	6378	

CUBRE POLVO C.V. BOOTS

6378

CONTINUACIÓN... ESCORT

	 28	APLICACIÓN / DESCRIPTION	DAI PARTS #
CUBRE POLVOS / C.V. BOOTS			
	91-03	CUBRE POLVO DERECHO LADO CAJA (CON TRIPOIDE)	6386
		CUBRE POLVO IZQUIERDO Y DERECHO LADO CAJA (AUT.)	6397



MISCELÁNEOS / AUTOMOTIVE RUBBER PARTS			
	81-90	BUJE PARA HORQUILLA (BRAZO) INFERIOR EXTERIOR (ZX2)	DAI-K-8417
		BUJE PARA HORQUILLA (BRAZO) INFERIOR INTERIOR (ZX2)	DAI-K-8436
	91-02	TOPE PARA AMORTIGUADOR TRASERO IZQUIERDO Y DERECHO	D-050
		TOPE PARA AMORTIGUADOR TRASERO IZQUIERDO Y DERECHO (ZX2)	
		TOPE PARA AMORTIGUADOR TRASERO IZQUIERDO Y DERECHO	D-074
	TOPE PARA AMORTIGUADOR TRASERO IZQUIERDO Y DERECHO (ZX2)		
	TOPE PARA AMORTIGUADOR FRONTAL IZQUIERDO Y DERECHO	D-0619	
	TOPE PARA AMORTIGUADOR FRONTAL IZQUIERDO Y DERECHO (ZX2)		

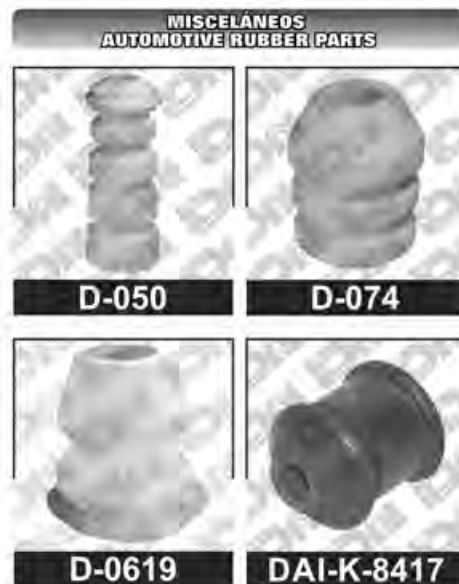

CONTINUACIÓN... ESCORT

28		APLICACIÓN / DESCRIPTION	DAI PARTS #
MISCELÁNEOS / AUTOMOTIVE RUBBER PARTS			
91-02	BUJE PARA PUNTA DE HORQUILLA CON ABRAZADERA DERECHO	DAI-B455-34-46XA	
	BUJE PARA PUNTA DE HORQUILLA CON ABRAZADERA DERECHO (ZX2)		
	BUJE PARA PUNTA DE HORQUILLA CON ABRAZADERA IZQUIERDO	DAI-B455-34-46YA	
	BUJE PARA PUNTA DE HORQUILLA CON ABRAZADERA IZQUIERDO (ZX2)		

**MISCELÁNEOS
AUTOMOTIVE RUBBER PARTS**

DAI-B455-34-46XA

DAI-B455-34-46YA
EXPEDITION
SOPORTES / TRANSMISSION & MOTOR MOUNTS

V8 4.6 V8 5.4	07-14	REPUESTO PARA SOPORTE DE MOTOR IZQUIERDO Y DERECHO	7599-9
	03-06	SOPORTE PARA MOTOR IZQUIERDO	7116
		SOPORTE PARA MOTOR DERECHO	7115
		SOPORTE PARA TRANSMISIÓN (4X4)	7173
	97-02	SOPORTE PARA TRANSMISIÓN	1896
		SOPORTE PARA MOTOR DERECHO	7110

**SOPORTES
TRANSMISSION & MOTOR MOUNTS**

1896

7110

7115

7116

7173

7599-9

CONTINUACIÓN... EXPEDITION

		APLICACIÓN / DESCRIPTION	DAI PARTS #
---	---	---------------------------------	--------------------

SOPORTES / TRANSMISSION & MOTOR MOUNTS

V8 4.6 V8 5.4	97-02	SOPORTE PARA MOTOR DERECHO (EQUIVALENTE AL 7110)	7106
	97-98	SOPORTE PARA MOTOR IZQUIERDO	7107
	99-02	SOPORTE PARA MOTOR DERECHO	7111

**SOPORTES
TRANSMISSION & MOTOR MOUNTS**



7106



7107



7111

	APLICACIÓN / DESCRIPTION	DAI PARTS #	DAI KIT PARTS #
---	---------------------------------	--------------------	------------------------

BASES PARA AMORTIGUADOR / STRUT MOUNTS

03-09	BASE PARA AMORTIGUADOR FRONTAL IZQUIERDA Y DERECHA (4X2 Y 4X4)		7367-KIT
	BASE PARA AMORTIGUADOR TRASERA IZQUIERDA Y DERECHA (4X2 Y 4X4)		7368-KIT

**BASES PARA AMORTIGUADOR
STRUT MOUNTS**



7367-KIT



7368-KIT

		APLICACIÓN / DESCRIPTION	DAI PARTS #
---	---	---------------------------------	--------------------

MISCELÁNEOS / AUTOMOTIVE RUBBER PARTS

	97-02	GOMA PARA BARRA ESTABILIZADORA (4X4)	64728
	03-06	BUJES PARA HORQUILLA SUPERIOR (4X2 Y 4X4)	DAI-1408040

**MISCELÁNEOS
AUTOMOTIVE RUBBER PARTS**



64728



DAI-1408040



EXPLORER

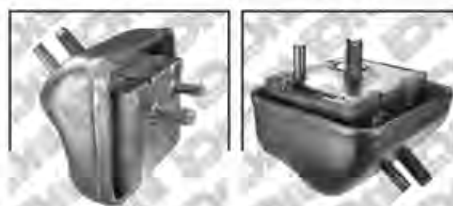

 		APLICACIÓN / DESCRIPTION	DAI PARTS #
SOPORTES / TRANSMISSION & MOTOR MOUNTS			
V6 3.5	11-16	SOPORTE PARA MOTOR TRASERO TORQUE STRUT	7739
		SOPORTE PARA MOTOR FRONTAL TORQUE STRUT	7740
V6 4.0	91-93	SOPORTE PARA MOTOR IZQUIERDO (4X4)	6948
	95-01	SOPORTE PARA TRANSMISIÓN	6890
	95-05	SOPORTE PARA MOTOR IZQUIERDO	7184
	01-05	SOPORTE PARA MOTOR DERECHO (4X4)	6884
		SOPORTE PARA MOTOR DERECHO (TRACCION TRASERA Y 4X4) (SPORT)	6891
V6 4.0 V6 4.6	01-10	SOPORTE PARA MOTOR DERECHO	7176
		SOPORTE PARA MOTOR IZQUIERDO	7177
		SOPORTE PARA TRANSMISIÓN (4X4)	7178
V8 5.0	96-01	SOPORTE PARA TRANSMISIÓN	7702

**SOPORTES
TRANSMISSION & MOTOR MOUNTS**

6884
6890

6891
6948

7176
7177

7178
7184

 		APLICACIÓN / DESCRIPTION	DAI PARTS #
CUBRE POLVOS / C.V. BOOTS			
	02-05	CUBRE POLVO IZQUIERDO Y DERECHO DE DIRECCIÓN HID.	63112

**CUBRE POLVO
C.V. BOOTS**

63112

CONTINUACIÓN... EXPLORER

	 28	APLICACIÓN / DESCRIPTION	DAI PARTS #
MISCELÁNEOS / AUTOMOTIVE RUBBER PARTS			
	80-96	GOMA PARA TIRANTE DE SUSPENSIÓN	64350
	81-90	GOMA PARA TIRANTE DE SUSPENSIÓN	64370
	95-06	GOMA PARA BARRA ESTABILIZADORA 3/4" (4X2 Y 4X4)	64703
	95-05	GOMA PARA BARRA ESTABILIZADORA 1" (4X2 Y 4X4)	64716
	99-09	GOMA PARA BARRA ESTABILIZADORA 1" (4X2 AMERICANA)	
	06-10	TORNILLO ESTABILIZADOR FRONTAL (MISMO K-8639)	DAI-K-8702



DAI-K-8702

EXPLORER SPORT

SOPORTES / TRANSMISSION & MOTOR MOUNTS			
V6 4.0	91-93	SOPORTE PARA MOTOR IZQUIERDO TRACCIÓN TRASERA (4X4)	6948
		SOPORTE PARA MOTOR DERECHO TRACCIÓN TRASERA (4X4)	6891
	91-05	SOPORTE PARA TRANSMISIÓN	6890



6890



CONTINUACIÓN... EXPLORER SPORT

  28		APLICACIÓN / DESCRIPTION	DAI PARTS #
SOPORTES / TRANSMISSION & MOTOR MOUNTS			
V6 4.0	01-05	SOPORTE PARA MOTOR IZQUIERDO TRACCIÓN TRASERA (4X4)	7184
		SOPORTE PARA MOTOR DERECHO (4X4)	6884





MISCELÁNEOS / AUTOMOTIVE RUBBER PARTS			
	95-03	GOMA PARA BARRA ESTABILIZADORA 1" (4X2 Y 4X4)	64716
	95-05	GOMA PARA BARRA ESTABILIZADORA 3/4" (4X2 Y 4X4)	64703

F-100

SOPORTES / TRANSMISSION & MOTOR MOUNTS			
L6 3.9 L6 4.9	65-76	SOPORTE PARA TRANSMISIÓN	1719
L6 4.9	74-84	SOPORTE PARA MOTOR IZQUIERDO	6871
		SOPORTE PARA MOTOR DERECHO	6870
	80-86	SOPORTE PARA TRANSMISIÓN	1798



CONTINUACIÓN... F-100

 		APLICACIÓN / DESCRIPTION	DAI PARTS #
SOPORTES / TRANSMISIÓN & MOTOR MOUNTS			
L6 4.9	85-96	SOPORTE PARA MOTOR IZQUIERDO	6769
		SOPORTE PARA MOTOR DERECHO	6764
	87-93	SOPORTE PARA TRANSMISIÓN	1896
	89-93	SOPORTE PARA MOTOR IZQUIERDO Y DERECHO	6893-H
		SOPORTE PARA TRANSMISIÓN	6923
94-96	SOPORTE PARA TRANSMISIÓN	1949	
V6 4.2	97-04	SOPORTE PARA TRANSMISIÓN	1949
		SOPORTE PARA MOTOR IZQUIERDO (EQUIVALENTE AL 7109)	7105
		SOPORTE PARA MOTOR DERECHO	7108
		SOPORTE PARA MOTOR IZQUIERDO (EQUIVALENTE AL 7105)	7109
		SOPORTE PARA MOTOR DERECHO	7112
V8 4.6	97-06	SOPORTE PARA MOTOR DERECHO (EQUIVALENTE AL 7110)	7106
	97-05	SOPORTE PARA MOTOR DERECHO	7110
	97-06	SOPORTE PARA MOTOR IZQUIERDO (4X4)	7111
	97-12	SOPORTE PARA TRANSMISIÓN	1949
		SOPORTE PARA TRANSMISIÓN (4X4)	7173

SOPORTES TRANSMISIÓN & MOTOR MOUNTS

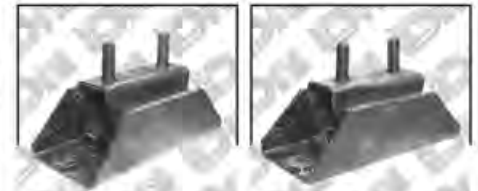

1896 **1949**



6764 **6769**



6893-H **6923**

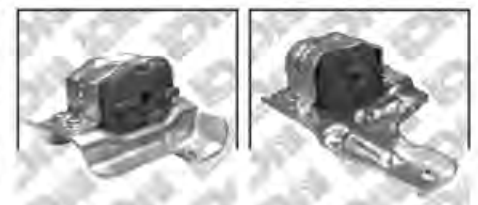

7105 **7106**



CONTINUACIÓN... F-100

		 28	APLICACIÓN / DESCRIPTION	DAI PARTS #	SOPORTES TRANSMISSION & MOTOR MOUNTS		
SOPORTES / TRANSMISSION & MOTOR MOUNTS							
V8 4.6	06-10	SOPORTE PARA MOTOR DERECHO		7601-H			
		SOPORTE PARA MOTOR IZQUIERDO		7580-H			
	06-12	SOPORTE PARA MOTOR IZQUIERDO		7382-H			
		SOPORTE PARA MOTOR DERECHO		7383-H			
V8 4.9	67-79	SOPORTE PARA MOTOR IZQUIERDO Y DERECHO		1714			
		SOPORTE PARA TRANSMISIÓN		1719			
V8 5.0	67-79	SOPORTE PARA TRANSMISIÓN		1719			
	80-93	SOPORTE PARA MOTOR IZQUIERDO Y DERECHO		1797			
		SOPORTE PARA TRANSMISIÓN		1798			
	87-97	SOPORTE PARA TRANSMISIÓN		1896			
	93-99	SOPORTE PARA MOTOR IZQUIERDO Y DERECHO		1897			
SOPORTE PARA TRANSMISIÓN		1949					
V8 5.4	97-05	SOPORTE PARA MOTOR DERECHO		7106			
		SOPORTE PARA MOTOR DERECHO		7110			
		SOPORTE PARA MOTOR IZQUIERDO (4X4)		7111			
	97-12	SOPORTE PARA TRANSMISIÓN (4X4)		7173			
		SOPORTE PARA TRANSMISIÓN		1949			
	05-10	SOPORTE PARA MOTOR IZQUIERDO		7580-H			
							
7110		7111		7173		7580-H	



CONTINUACIÓN... F-100

 		APLICACIÓN / DESCRIPTION	DAI PARTS #
SOPORTES / TRANSMISSION & MOTOR MOUNTS			
V8 5.4	05-10	SOPORTE PARA MOTOR DERECHO	7601-H
	05-12	SOPORTE PARA MOTOR IZQUIERDO	7382-H
		SOPORTE PARA MOTOR DERECHO	7383-H
V8 5.8	66-67	SOPORTE PARA MOTOR IZQUIERDO	1879
		SOPORTE PARA MOTOR DERECHO	1880
	66-79	SOPORTE PARA TRANSMISIÓN	1719
	80-93	SOPORTE PARA MOTOR IZQUIERDO Y DERECHO	1797
		SOPORTE PARA TRANSMISIÓN	1798
	87-97	SOPORTE PARA TRANSMISIÓN	1896
	92-99	SOPORTE PARA MOTOR IZQUIERDO Y DERECHO	1897
		SOPORTE PARA TRANSMISIÓN	1949
V8 5.9	68-76	SOPORTE PARA MOTOR IZQUIERDO	1879
		SOPORTE PARA MOTOR DERECHO	1880
		SOPORTE PARA TRANSMISIÓN	1719
V8 6.8	99-12	SOPORTE PARA TRANSMISIÓN	1949
		SOPORTE PARA TRANSMISIÓN (4X4)	7173
V8 6.9	83-86	SOPORTE PARA TRANSMISIÓN	1798
V8 7.3	88-97	SOPORTE PARA MOTOR DERECHO	7225
		SOPORTE PARA MOTOR IZQUIERDO	7226



CONTINUACIÓN... F-100

	28	APLICACIÓN / DESCRIPTION	DAI PARTS #
--	----	--------------------------	-------------

SOPORTES / TRANSMISSION & MOTOR MOUNTS

V8 7.3	88-98	SOPORTE PARA TRANSMISIÓN	1896
	99-03	SOPORTE PARA TRANSMISIÓN	1949
		SOPORTE PARA TRANSMISIÓN (4X4)	7173

V8 7.5	83-86	SOPORTE PARA TRANSMISIÓN	1798
	87-93	SOPORTE PARA TRANSMISIÓN	1896
	94-97	SOPORTE PARA TRANSMISIÓN	1949

**SOPORTES
TRANSMISSION & MOTOR MOUNTS**

1798

1896

1949

7173
MISCELÁNEOS / AUTOMOTIVE RUBBER PARTS

	65-71	GOMA PARA TIRANTE DE SUSPENSIÓN	6051
	65-79	GOMA PARA TIRANTE DE SUSPENSIÓN (4X4)	64470
80-96		BUJE PARA MUELLE 1 X 7/8" X 1 11/16" X 1/2"	9145
		BUJE PARA EJE (PARALELO 4X2)	DAI-K-8300
		GOMA PARA TIRANTE DE SUSPENSIÓN (4X2)	64370
		GOMA PARA TIRANTE DE SUSPENSIÓN (4X2)	64350

**MISCELÁNEOS
AUTOMOTIVE RUBBER PARTS**

6051

9145



64350

64370

64470

DAI-K-8300

F-150

 		APLICACIÓN / DESCRIPTION	DAI PARTS #
SOPORTES / TRANSMISSION & MOTOR MOUNTS			
L6 3.9	65-76	SOPORTE PARA TRANSMISIÓN	1719
L6 4.9	65-76	SOPORTE PARA TRANSMISIÓN	1719
	74-84	SOPORTE PARA MOTOR IZQUIERDO	6871
		SOPORTE PARA MOTOR DERECHO	6870
	80-86	SOPORTE PARA TRANSMISIÓN	1798
	85-96	SOPORTE PARA MOTOR IZQUIERDO	6769
		SOPORTE PARA MOTOR DERECHO	6764
	87-93	SOPORTE PARA TRANSMISIÓN	1896
	89-93	SOPORTE PARA MOTOR IZQUIERDO Y DERECHO	6893-H
		SOPORTE PARA TRANSMISIÓN	6923
94-96	SOPORTE PARA TRANSMISIÓN	1949	
V6 2.7	15-16	REPUESTO PARA SOPORTE DE MOTOR IZQUIERDO Y DERECHO	7599-9
V6 3.5	11-12		
V6 3.7	11-13		
V8 4.6	09-10		
V8 5.4			
V6 3.8	86-94	SOPORTE PARA MOTOR DERECHO	1865
		REPUESTO PARA SOPORTE MOTOR DERECHO (1865)	1849
		SOPORTE PARA MOTOR IZQUIERDO	1866
		REPUESTO PARA SOPORTE MOTOR IZQUIERDO (1866)	1850



389 **IMPORTANTE:** Identifica nuestro producto con el grabado del logo  No aceptes imitaciones.



CONTINUACIÓN... F-150

  28		APLICACIÓN / DESCRIPTION	DAI PARTS #
SOPORTES / TRANSMISSION & MOTOR MOUNTS			
V6 4.2	97-04	SOPORTE PARA TRANSMISIÓN	1949
		SOPORTE PARA MOTOR IZQUIERDO (EQUIVALENTE AL 7109)	7105
		SOPORTE PARA MOTOR DERECHO	7108
		SOPORTE PARA MOTOR IZQUIERDO (EQUIVALENTE AL 7105)	7109
		SOPORTE PARA MOTOR DERECHO	7112
V8 4.6	97-06	SOPORTE PARA MOTOR DERECHO (EQUIVALENTE AL 7110)	7106
		SOPORTE PARA MOTOR IZQUIERDO AUT. Y STD., (4X2)	7110
V8 5.4	97-05	SOPORTE PARA MOTOR DERECHO (EQUIVALENTE AL 7110)	7106
		SOPORTE PARA MOTOR IZQUIERDO AUT. Y STD., (4X2)	7110
V8 4.6 V8 5.4	06-12	SOPORTE PARA MOTOR IZQUIERDO	7382-H
		SOPORTE PARA MOTOR DERECHO	7383-H
	97-05	SOPORTE PARA MOTOR IZQUIERDO (4X4)	7111
	97-12	SOPORTE PARA TRANSMISIÓN	1949
		SOPORTE PARA TRANSMISIÓN (4X4)	7173
	05-10	SOPORTE PARA MOTOR DERECHO	7601-H
SOPORTE PARA MOTOR IZQUIERDO		7580-H	

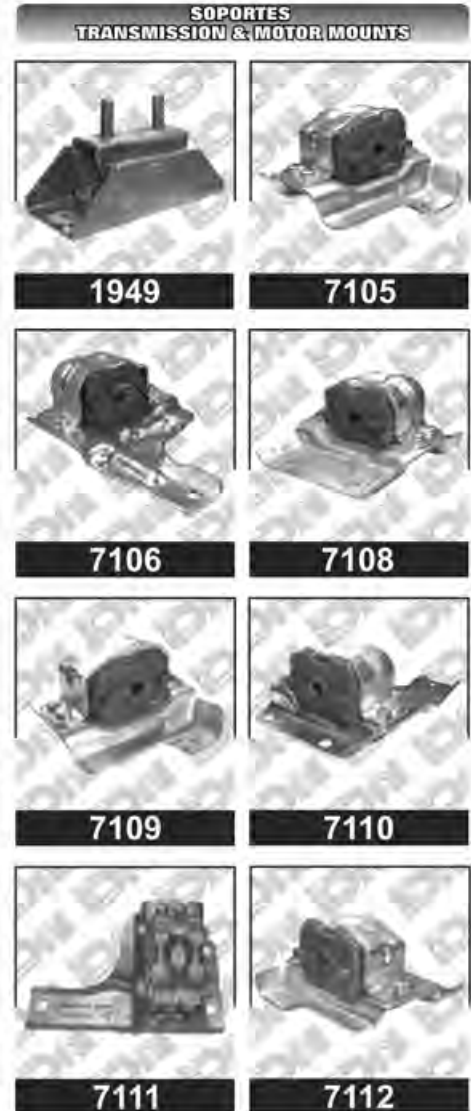

CONTINUACIÓN... F-150

		APLICACIÓN / DESCRIPTION	DAI PARTS #
SOPORTES / TRANSMISSION & MOTOR MOUNTS			
V8 5.0	67-79	SOPORTE PARA TRANSMISIÓN	1719
	92-99	SOPORTE PARA TRANSMISIÓN	1949
		SOPORTE PARA MOTOR IZQUIERDO Y DERECHO	1897
V8 5.0 V8 5.8	80-93	SOPORTE PARA MOTOR IZQUIERDO Y DERECHO	1797
		SOPORTE PARA TRANSMISIÓN	1798
	87-97	SOPORTE PARA TRANSMISIÓN	1896
V8 5.8	66-76	SOPORTE PARA MOTOR IZQUIERDO	1879
	66-67	SOPORTE PARA MOTOR DERECHO	1880
	66-79	SOPORTE PARA TRANSMISIÓN	1719
	92-99	SOPORTE PARA MOTOR IZQUIERDO Y DERECHO	1897
		SOPORTE PARA TRANSMISIÓN	1949
V8 5.9	68-76	SOPORTE PARA TRANSMISIÓN	1719
		SOPORTE PARA MOTOR IZQUIERDO	1879
		SOPORTE PARA MOTOR DERECHO	1880
V8 6.8	99-12	SOPORTE PARA TRANSMISIÓN	1949
		SOPORTE PARA TRANSMISIÓN (4X4)	7173
V8 6.9	1987	SOPORTE PARA TRANSMISIÓN	1896
V8 6.9 V8 7.5	83-86	SOPORTE PARA TRANSMISIÓN	1798



CONTINUACIÓN... F-150

28		APLICACIÓN / DESCRIPTION	DAI PARTS #
SOPORTES / TRANSMISSION & MOTOR MOUNTS			
V8 7.3	88-97	SOPORTE PARA MOTOR DERECHO	7225
		SOPORTE PARA MOTOR IZQUIERDO	7226
	88-98	SOPORTE PARA TRANSMISIÓN	1896
	99-03	SOPORTE PARA TRANSMISIÓN	1949
		SOPORTE PARA TRANSMISIÓN (4X4)	7173
V8 7.5	87-93	SOPORTE PARA TRANSMISIÓN	1896
	94-97	SOPORTE PARA TRANSMISIÓN	1949



28		APLICACIÓN / DESCRIPTION	DAI PARTS #	DAI KIT PARTS #
BASES PARA AMORTIGUADOR / STRUT MOUNTS				
04-08		BASE PARA AMORTIGUADOR FRONTAL IZQUIERDA Y DERECHA (4X4 Y USA)		7366-KIT



28		APLICACIÓN / DESCRIPTION	DAI PARTS #
MISCELÁNEOS / AUTOMOTIVE RUBBER PARTS			
	65-79	GOMA PARA TIRANTE DE SUSPENSIÓN (4X4)	64470
	80-96	BUJE PARA EJE (PARALELO 4X2)	DAI-K-8300



CONTINUACIÓN... F-150

  28		APLICACIÓN / DESCRIPTION	DAI PARTS #
MISCELÁNEOS / AUTOMOTIVE RUBBER PARTS			
80-96		GOMA PARA TIRANTE DE SUSPENSIÓN (4X4)	64370
		GOMA PARA TIRANTE DE SUSPENSIÓN (4X4)	64350
85-03		GOMA SUJETADORA DE ESCAPE	6567
85-08		COPLÉ PARA DIRECCIÓN HID. (SINFIN REBAJADO DE .725" 1 PERNO GRUESO Y 1 PERNO DELGADO)	604
04-08		BUJES PARA HORQUILLA SUPERIOR 4X2 USA	DAI-1408040
		BUJES PARA HORQUILLA SUPERIOR (4X4)	

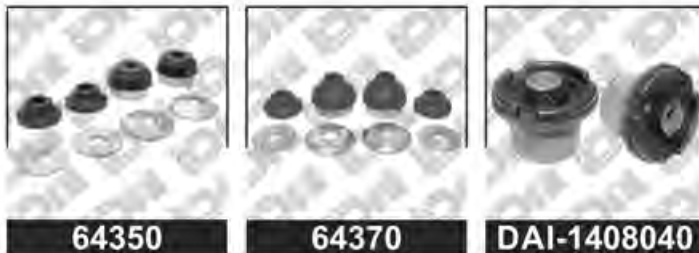

F-200

SOportes / TRANSMISSION & MOTOR MOUNTS			
V6 3.8	86-94	SOPORE PARA MOTOR DERECHO	1865
		REPUESTO PARA SOPORE MOTOR DERECHO (1865)	1849
		SOPORE PARA MOTOR IZQUIERDO	1866
		REPUESTO PARA SOPORE MOTOR IZQUIERDO (1866)	1850



F-250

	28	APLICACIÓN / DESCRIPTION	DAI PARTS #
--	----	--------------------------	-------------

SOPORTES / TRANSMISSION & MOTOR MOUNTS

L6 3.9 L6 4.9	65-76	SOPORTE PARA TRANSMISIÓN	1719
------------------	-------	--------------------------	------

L6 4.9	74-84	SOPORTE PARA MOTOR IZQUIERDO	6871
		SOPORTE PARA MOTOR DERECHO	6870
	80-86	SOPORTE PARA TRANSMISIÓN	1798
	85-96	SOPORTE PARA MOTOR IZQUIERDO	6769
		SOPORTE PARA MOTOR DERECHO	6764
	87-93	SOPORTE PARA TRANSMISIÓN	1896
	89-93	SOPORTE PARA MOTOR IZQUIERDO Y DERECHO	6893-H
		SOPORTE PARA TRANSMISIÓN	6923
94-96	SOPORTE PARA TRANSMISIÓN	1949	

V6 4.2	97-04	SOPORTE PARA MOTOR IZQUIERDO (EQUIVALENTE AL 7109)	7105
		SOPORTE PARA MOTOR DERECHO	7112
		SOPORTE PARA MOTOR IZQUIERDO (EQUIVALENTE AL 7105)	7109
		SOPORTE PARA MOTOR DERECHO	7108
		SOPORTE PARA TRANSMISIÓN	1949

SOPORTES TRANSMISSION & MOTOR MOUNTS



1719



1798



1896



1949



6764



6769



6870



6871



6893-H

6923

7105

7108



7109

7112



CONTINUACIÓN... F-250

 		APLICACIÓN / DESCRIPTION	DAI PARTS #
SOPORTES / TRANSMISSION & MOTOR MOUNTS			
V8 4.6	99-06	SOPORTE PARA MOTOR DERECHO (EQUIVALENTE AL 7110)	7106
	97-02	SOPORTE PARA MOTOR DERECHO	7107
	97-05	SOPORTE PARA MOTOR IZQUIERDO (EQUIVALENTE AL 7106)	7110
		SOPORTE PARA MOTOR IZQUIERDO (4X4)	7111
	97-12	SOPORTE PARA TRANSMISIÓN	1949
	97-12	SOPORTE PARA TRANSMISIÓN (4X4)	7173
	06-12	SOPORTE PARA MOTOR IZQUIERDO	7382-H
SOPORTE PARA MOTOR DERECHO		7383-H	
V8 5.0	67-79	SOPORTE PARA TRANSMISIÓN	1719
	93-99	SOPORTE PARA TRANSMISIÓN	1949
	80-93	SOPORTE PARA MOTOR IZQUIERDO Y DERECHO	1797
		SOPORTE PARA TRANSMISIÓN	1798
	87-97	SOPORTE PARA TRANSMISIÓN	1896
	93-99	SOPORTE PARA MOTOR IZQUIERDO Y DERECHO	1897
V8 5.4	97-12	SOPORTE PARA TRANSMISIÓN	1949
		SOPORTE PARA TRANSMISIÓN (4X4)	7173
	97-05	SOPORTE PARA MOTOR IZQUIERDO (EQUIVALENTE AL 7106)	7110
		SOPORTE PARA MOTOR IZQUIERDO (4X4)	7111



CONTINUACIÓN... F-250

	28	APLICACIÓN / DESCRIPTION	DAI PARTS #
SOPORTES / TRANSMISSION & MOTOR MOUNTS			
V8 5.4	97-05	SOPORTE PARA MOTOR DERECHO (EQUIVALENTE AL 7110)	7106
	06-12	SOPORTE PARA MOTOR IZQUIERDO	7382-H
		SOPORTE PARA MOTOR DERECHO	7383-H
V8 5.4	08-10	REPUESTO PARA SOPORTE DE MOTOR IZQUIERDO Y DERECHO	7599-9
V8 6.2	11-16		
V10 6.8	08-10		
V8 6.4	08-10	REPUESTO PARA SOPORTE DE MOTOR IZQUIERDO Y DERECHO	
V8 6.7	11-16	(DIESEL)	
V8 5.8	66-67	SOPORTE PARA MOTOR IZQUIERDO	1879
	66-76	SOPORTE PARA MOTOR DERECHO	1880
	66-79	SOPORTE PARA TRANSMISIÓN	1719
	80-93	SOPORTE PARA MOTOR IZQUIERDO Y DERECHO	1797
		SOPORTE PARA TRANSMISIÓN	1798
	87-97	SOPORTE PARA TRANSMISIÓN	1896
	92-99	SOPORTE PARA MOTOR IZQUIERDO Y DERECHO	1897
	92-99	SOPORTE PARA TRANSMISIÓN	1949
V8 5.9	68-76	SOPORTE PARA TRANSMISIÓN	1719
		SOPORTE PARA MOTOR IZQUIERDO	1879
		SOPORTE PARA MOTOR DERECHO	1880
V8 6.2 V8 6.7	11-16	REPUESTO PARA SOPORTE DE MOTOR DERECHO (OVALADO)	7717-9

SOPORTES TRANSMISSION & MOTOR MOUNTS

1719

1797

1798

1879

1880

1896

1897

1949

7106

7382-H

7383-H

7599-9

7717-9

CONTINUACIÓN... F-250

		 28	APLICACIÓN / DESCRIPTION	DAI PARTS #
SOPORTES / TRANSMISSION & MOTOR MOUNTS				
V8 6.8	99-12	SOPORTE PARA TRANSMISIÓN		1949
		SOPORTE PARA TRANSMISIÓN (4X4)		7173
V8 6.9	1987	SOPORTE PARA TRANSMISIÓN		1896
		SOPORTE PARA MOTOR IZQUIERDO		7225
V8 6.9 V8 7.5	83-86	SOPORTE PARA TRANSMISIÓN		1798
V8 7.3	88-97	SOPORTE PARA MOTOR IZQUIERDO		7226
		SOPORTE PARA MOTOR DERECHO		7225
	88-98	SOPORTE PARA TRANSMISIÓN		1896
		SOPORTE PARA TRANSMISIÓN		1949
99-03	SOPORTE PARA TRANSMISIÓN (4X4)		7173	
	V8 7.5	87-93	SOPORTE PARA TRANSMISIÓN	
94-97		SOPORTE PARA TRANSMISIÓN		1949

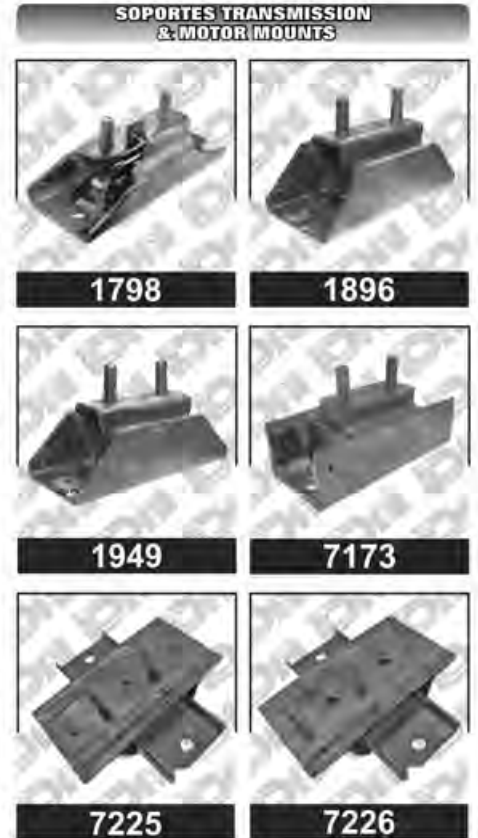

MISCELÁNEOS / AUTOMOTIVE RUBBER PARTS				
	65-79	GOMA PARA TIRANTE DE SUSPENSIÓN (4X2)	64470	
	75-77	GOMA PARA TIRANTE DE SUSPENSIÓN	6051	
	80-98	BUJE PARA EJE PARALELO (4X2)		DAI-K-8300
		GOMA PARA TIRANTE DE SUSPENSIÓN (4X2)		64370
		GOMA PARA TIRANTE DE SUSPENSIÓN (4X2)		64350
	85-03	GOMA SUJETADORA DE ESCAPE		6567



F-350

	28	APLICACIÓN / DESCRIPTION	DAI PARTS #
--	----	--------------------------	-------------

SOPORTES / TRANSMISSION & MOTOR MOUNTS

L6 3.9 L6 4.9	65-76	SOPORTE PARA TRANSMISIÓN	1719
------------------	-------	--------------------------	------

L6 4.9	74-84	SOPORTE PARA MOTOR IZQUIERDO	6871
		SOPORTE PARA MOTOR DERECHO	6870
	85-96	SOPORTE PARA MOTOR IZQUIERDO	6769
		SOPORTE PARA MOTOR DERECHO	6764
	89-93	SOPORTE PARA MOTOR IZQUIERDO Y DERECHO	6893-H
		SOPORTE PARA TRANSMISIÓN	6923
	80-86	SOPORTE PARA TRANSMISIÓN	1798
	87-93	SOPORTE PARA TRANSMISIÓN	1896
94-96	SOPORTE PARA TRANSMISIÓN	1949	

V6 4.2	97-04	SOPORTE PARA MOTOR IZQUIERDO (EQUIVALENTE AL 7105)	7109
		SOPORTE PARA MOTOR DERECHO	7108
		SOPORTE PARA TRANSMISIÓN	1949
		SOPORTE PARA MOTOR IZQUIERDO (EQUIVALENTE AL 7109)	7105
		SOPORTE PARA MOTOR DERECHO	7112

SOPORTES TRANSMISSION & MOTOR MOUNTS

1719
1798

1896
1949

6764
6769

6870
6871

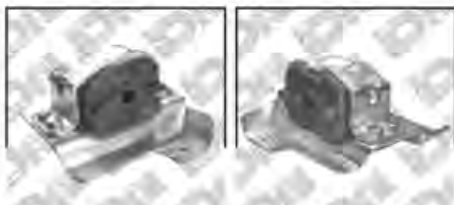
6893-H
6923
7105
7108

7109
7112

CONTINUACIÓN... F-350

 		APLICACIÓN / DESCRIPTION	DAI PARTS #
SOPORTES / TRANSMISSION & MOTOR MOUNTS			
V8 3.9	53-77	SOPORTE PARA MOTOR FRONTAL SUPERIOR IZQUIERDO Y DERECHO	1431
	55-64	SOPORTE PARA MOTOR SUPERIOR IZQUIERDO Y DERECHO	1640
V8 4.2	53-77	SOPORTE PARA MOTOR FRONTAL SUPERIOR IZQUIERDO Y DERECHO	1431
		SOPORTE PARA TRANSMISIÓN	1432
	55-64	SOPORTE PARA MOTOR INFERIOR IZQUIERDO Y DERECHO	1443
		SOPORTE PARA MOTOR SUPERIOR IZQUIERDO Y DERECHO	1640
V8 4.6	99-06	SOPORTE PARA MOTOR DERECHO (EQUIVALENTE AL 7110)	7106
	97-05	SOPORTE PARA MOTOR IZQUIERDO	7110
		SOPORTE PARA MOTOR IZQUIERDO (4X4)	7111
	97-12	SOPORTE PARA TRANSMISIÓN (4X4)	7173
		SOPORTE PARA TRANSMISIÓN	1949
	06-10	SOPORTE PARA MOTOR IZQUIERDO	7580-H
		SOPORTE PARA MOTOR DERECHO	7601-H
	06-12	SOPORTE PARA MOTOR IZQUIERDO	7382-H
SOPORTE PARA MOTOR DERECHO		7383-H	
V8 5.0	55-64	SOPORTE PARA MOTOR SUPERIOR IZQUIERDO Y DERECHO	1640
	67-79	SOPORTE PARA TRANSMISIÓN	1719



CONTINUACIÓN... F-350

	28	APLICACIÓN / DESCRIPTION	DAI PARTS #
--	----	--------------------------	-------------

SOPORTES / TRANSMISSION & MOTOR MOUNTS

V8 5.0	80-93	SOPORTE PARA MOTOR IZQUIERDO Y DERECHO	1797
		SOPORTE PARA TRANSMISIÓN	1798
	87-97	SOPORTE PARA TRANSMISIÓN	1896
	93-99	SOPORTE PARA MOTOR IZQUIERDO Y DERECHO	1897
SOPORTE PARA TRANSMISIÓN		1949	

V8 5.4	97-05	SOPORTE PARA MOTOR IZQUIERDO	7110
		SOPORTE PARA MOTOR IZQUIERDO (4X4)	7111
	97-12	SOPORTE PARA TRANSMISIÓN	1949
		SOPORTE PARA TRANSMISIÓN (4X4)	7173
	99-03	SOPORTE PARA MOTOR DERECHO (TRITON SD)	7115
		SOPORTE PARA MOTOR IZQUIERDO (TRITON SD)	7116
	99-05	SOPORTE PARA MOTOR DERECHO (EQUIVALENTE AL 7110)	7106
	05-10	SOPORTE PARA MOTOR DERECHO	7601-H
		SOPORTE PARA MOTOR IZQUIERDO	7580-H

SOPORTES TRANSMISSION & MOTOR MOUNTS

1797
1798

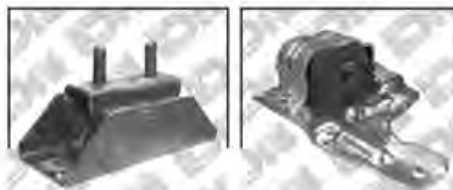
1896
1897

1949
7106

7110
7111

7115
7116
7173
7580-H

7601-H

CONTINUACIÓN... F-350

 		APLICACIÓN / DESCRIPTION	DAI PARTS #
SOPORTES / TRANSMISSION & MOTOR MOUNTS			
V8 5.4	06-12	SOPORTE PARA MOTOR IZQUIERDO	7382-H
		SOPORTE PARA MOTOR DERECHO	7383-H
V8 5.4	08-10	REPUESTO PARA SOPORTE DE MOTOR IZQUIERDO Y DERECHO	7599-9
V8 6.2	11-16		
V10 6.8	08-10		
V8 6.4	08-10	REPUESTO PARA SOPORTE DE MOTOR IZQUIERDO Y DERECHO (DIESEL)	
V8 6.7	11-16		
V8 5.7 V8 6.4	67-79	SOPORTE PARA MOTOR IZQUIERDO Y DERECHO	1713
		SOPORTE PARA TRANSMISIÓN	1719
V8 5.8	67-79	SOPORTE PARA TRANSMISIÓN	1719
	66-67	SOPORTE PARA MOTOR IZQUIERDO	1879
		SOPORTE PARA MOTOR DERECHO	1880
	80-93	SOPORTE PARA MOTOR IZQUIERDO Y DERECHO	1797
		SOPORTE PARA TRANSMISIÓN	1798
	87-97	SOPORTE PARA TRANSMISIÓN	1896
	92-99	SOPORTE PARA MOTOR IZQUIERDO Y DERECHO	1897
		SOPORTE PARA TRANSMISIÓN	1949



CONTINUACIÓN... F-350

  28		APLICACIÓN / DESCRIPTION	DAI PARTS #
SOPORTES / TRANSMISSION & MOTOR MOUNTS			
V8 5.9	68-76	SOPORTE PARA MOTOR IZQUIERDO	1879
		SOPORTE PARA MOTOR DERECHO	1880
		SOPORTE PARA TRANSMISIÓN	1719
V8 6.2	10-16	REPUESTO PARA SOPORTE DE MOTOR DERECHO (OVALADO)	7717-9
V8 6.7	11-16		
V8 6.8	99-12	SOPORTE PARA TRANSMISIÓN	1949
		SOPORTE PARA TRANSMISIÓN (4X4)	7173
V8 6.9	1987	SOPORTE PARA TRANSMISIÓN	1896
		SOPORTE PARA MOTOR DERECHO	7225
	83-86	SOPORTE PARA TRANSMISIÓN	1798
V8 7.3	88-97	SOPORTE PARA MOTOR IZQUIERDO	7226
		SOPORTE PARA MOTOR DERECHO	7225
	88-98	SOPORTE PARA TRANSMISIÓN	1896
		SOPORTE PARA TRANSMISIÓN	1949
		SOPORTE PARA TRANSMISIÓN (4X4)	7173
V8 7.5	83-86	SOPORTE PARA TRANSMISIÓN	1798
	87-93	SOPORTE PARA TRANSMISIÓN	1896
	94-97	SOPORTE PARA TRANSMISIÓN	1949
V10 6.8	00-10	SOPORTE PARA TRANSMISIÓN	1949
		SOPORTE PARA MOTOR IZQUIERDO	7114

SOPORTES TRANSMISSION & MOTOR MOUNTS

1897

1719

1798

1880

1896

1949

7114

7173

7225

7226

7717-9
NUEVO



CONTINUACIÓN... F-350

			APLICACIÓN / DESCRIPTION	DAI PARTS #
SOPORTES / TRANSMISSION & MOTOR MOUNTS				
V10 6.8	00-10		SOPORTE PARA MOTOR DERECHO	7113
	99-12		SOPORTE PARA TRANSMISIÓN	7173

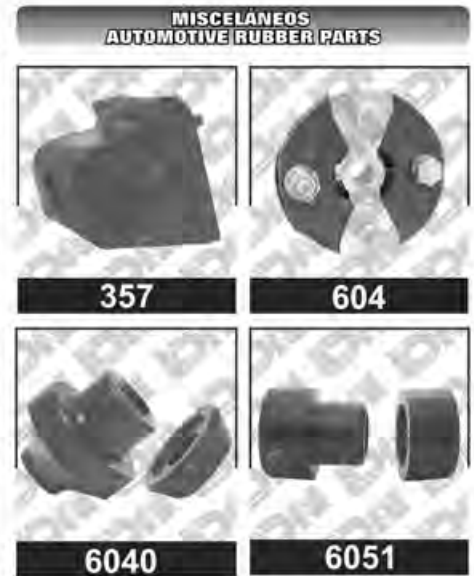

MISCELÁNEOS / AUTOMOTIVE RUBBER PARTS

		TOPE PARA SUSPENSIÓN DELANTERA	357
61-79		GOMA PARA TIRANTE DE SUSPENSIÓN (4X2)	64470
71-72		GOMA PARA TIRANTE DE SUSPENSIÓN	64450
75-77		GOMA PARA TIRANTE DE SUSPENSIÓN	6051
79-85		GOMAS PARA TIRANTE DE SUSPENSIÓN	6040
80-98		GOMA PARA TIRANTE DE SUSPENSIÓN (4X2)	64350
		GOMA PARA TIRANTE DE SUSPENSIÓN	64370
		BUJE PARA EJE (PARALELO (4X2))	DAI-K-8300
85-08		COPEL PARA DIRECCIÓN HID. (SINFIN REBAJADO DE .725" 1 PERNO GRUESO Y 1 PERNO DELGADO)	604



F-450

		 28	APLICACIÓN / DESCRIPTION	DAI PARTS #
SOPORTES / TRANSMISSION & MOTOR MOUNTS				
V6 6.0 V6 6.8 V6 7.3	99-07		SOPORTE PARA TRANSMISIÓN	7173
V8 3.9 V8 4.2	53-77		SOPORTE PARA MOTOR FRONTAL SUPERIOR IZQUIERDO Y DERECHO	1431
			SOPORTE PARA TRANSMISIÓN	1432
V8 3.9 V8 4.2 V8 5.0	55-64		SOPORTE PARA MOTOR SUPERIOR IZQUIERDO Y DERECHO	1640
V8 5.0	93-10		SOPORTE PARA TRANSMISIÓN	1949
V8 5.4 V8 6.2 V8 6.7	07-12 11-13 10-16		REPUESTO PARA SOPORTE DE MOTOR DERECHO (OVALADO)	7717-9

NUEVO

MISCELÁNEOS / AUTOMOTIVE RUBBER PARTS		
		TOPE PARA SUSPENSIÓN DELANTERA
		357



F-500

  28		APLICACIÓN / DESCRIPTION	DAI PARTS #
SOPORTES / TRANSMISSION & MOTOR MOUNTS			
V6 6.0 V6 6.8 V6 7.3	99-07	SOPORTE PARA TRANSMISIÓN	7173



F-550

SOPORTES / TRANSMISSION & MOTOR MOUNTS			
V8 3.9 V8 4.2	53-77	SOPORTE PARA MOTOR FRONTAL SUPERIOR IZQUIERDO Y DERECHO	1431
		SOPORTE PARA MOTOR INFERIOR IZQUIERDO Y DERECHO	1443
		SOPORTE PARA TRANSMISIÓN	1432
V8 3.9 V8 4.2 V8 5.0	55-64	SOPORTE PARA MOTOR SUPERIOR IZQUIERDO Y DERECHO	1640
V8 6.2 V8 6.7	11-13 08-16	REPUESTO PARA SOPORTE DE MOTOR DERECHO (OVALADO)	7717-9



F-600

 28		APLICACIÓN / DESCRIPTION	DAI PARTS #
SOPORTES / TRANSMISSION & MOTOR MOUNTS			
V8 3.9 V8 4.2	53-77	SOPORTE PARA MOTOR FRONTAL SUPERIOR IZQUIERDO Y DERECHO	1431
		SOPORTE PARA MOTOR INFERIOR IZQUIERDO Y DERECHO	1443
		SOPORTE PARA TRANSMISIÓN	1432
V8 5.5	55-88	SOPORTE PARA TRANSMISIÓN IZQUIERDO Y DERECHO	1685
		SOPORTE PARA MOTOR Y TRANSMISIÓN SUPERIOR IZQUIERDO Y DERECHO	1652

SOPORTES TRANSMISSION & MOTOR MOUNTS

1431

1432

1443

1652

1685
F-650

SOPORTES / TRANSMISSION & MOTOR MOUNTS			
V8 3.9 V8 4.2 V8 5.0	55-64	SOPORTE PARA MOTOR SUPERIOR IZQUIERDO Y DERECHO	1640

SOPORTES TRANSMISSION & MOTOR MOUNTS

1640

F-700

		APLICACIÓN / DESCRIPTION	DAI PARTS #
SOPORTES / TRANSMISSION & MOTOR MOUNTS			
V8 3.9 V8 4.2 V8 5.0	55-64	SOPORTE PARA MOTOR SUPERIOR IZQUIERDO Y DERECHO	1640
V8 4.8 V8 5.7 V8 6.4	55-79	SOPORTE PARA TRANSMISIÓN TRASERO INFERIOR	1700



F-800

		APLICACIÓN / DESCRIPTION	DAI PARTS #
SOPORTES / TRANSMISSION & MOTOR MOUNTS			
V8 4.8 V8 5.7 V8 6.4	55-79	SOPORTE PARA TRANSMISIÓN TRASERO INFERIOR	1700



FAIRMONT

		APLICACIÓN / DESCRIPTION	DAI PARTS #
SOPORTES / TRANSMISSION & MOTOR MOUNTS			
L6 3.3	78-82	SOPORTE PARA TRANSMISIÓN AUT.	1845
		SOPORTE PARA TRANSMISIÓN STD.	1846
V8 4.2 V8 5.0	78-82	SOPORTE PARA MOTOR IZQUIERDO	1862



CONTINUACIÓN... FAIRMONT

 28		APLICACIÓN / DESCRIPTION	DAI PARTS #
SOPORTES / TRANSMISSION & MOTOR MOUNTS			
V8 4.2 V8 5.0	78-82	REPUESTO PARA SOPORTE MOTOR IZQUIERDO (1862)	1847
		SOPORTE PARA MOTOR DERECHO	1863
		REPUESTO PARA SOPORTE MOTOR DERECHO (1863)	1848
		SOPORTE PARA TRANSMISIÓN STD.	1846
	78-84	SOPORTE PARA TRANSMISIÓN AUT.	1845



 28		APLICACIÓN / DESCRIPTION	DAI PARTS #	DAI KIT PARTS #
BASES PARA AMORTIGUADOR / STRUT MOUNTS				
78-83		REPUESTO BASE DE AMORTIGUADOR FRONTAL IZQUIERDA Y DERECHA		6729-KIT



 28		APLICACIÓN / DESCRIPTION	DAI PARTS #
CUBRE POLVOS / C.V. BOOTS			
	78-83	CUBRE POLVO IZQUIERDO Y DERECHO DE DIRECCIÓN HID.	6342
		CUBRE POLVO IZQUIERDO Y DERECHO DE DIRECCIÓN STD.	6372



CONTINUACIÓN... FAIRMONT

 		APLICACIÓN / DESCRIPTION	DAI PARTS #
MISCELÁNEOS / AUTOMOTIVE RUBBER PARTS			
78-84		TORNILLO ESTABILIZADOR (10", 254.0 mm)	6103
		COPLÉ PARA DIRECCIÓN (SINFÍN DE.725" 2 PERNOS UNIVERSALES REPUESTO 626)	611
78-89		GALLETA PARA DIRECCIÓN STD. Y HID. (2 PERNOS DELGADOS COMPLETO 611)	626
		GOMA PARA BARRA ESTABILIZADORA	6064
		GOMA PARA BARRA ESTABILIZADORA 1"	6408
		TOPE PARA AMORTIGUADOR FRONTAL IZQUIERDO Y DERECHO	D-0620

**MISCELÁNEOS
AUTOMOTIVE RUBBER PARTS**



D-0620



611



626



6064



6103



6408

FALCON

SOPORTES / TRANSMISSION & MOTOR MOUNTS			
L6 2.4	62-66	SOPORTE PARA MOTOR IZQUIERDO	1751
		SOPORTE PARA MOTOR DERECHO	1752
		SOPORTE PARA TRANSMISIÓN STD. Y AUT.	1758

**SOPORTES
TRANSMISSION & MOTOR MOUNTS**



1751



1752



1758



CONTINUACIÓN... FALCON

	 28	APLICACIÓN / DESCRIPTION	DAI PARTS #
--	--	--------------------------	-------------

SOPORTES / TRANSMISSION & MOTOR MOUNTS

L6 2.4 L6 2.8 L6 3.3 L6 4.1	60-73	SOPORTE PARA MOTOR IZQUIERDO Y DERECHO	6908
--------------------------------------	-------	--	------

L6 2.9 L6 3.3	62-66	SOPORTE PARA MOTOR IZQUIERDO	1751
		SOPORTE PARA MOTOR DERECHO	1752
		SOPORTE PARA TRANSMISIÓN STD. Y AUT.	1758

V8 4.3	63-69	SOPORTE PARA TRANSMISIÓN STD. Y AUT.	1653
		SOPORTE PARA MOTOR IZQUIERDO	1926
	66-70	SOPORTE PARA TRANSMISIÓN STD. Y AUT.	1758

V8 5.0	66-70	SOPORTE PARA MOTOR IZQUIERDO Y DERECHO	1727
		SOPORTE PARA TRANSMISIÓN STD. Y AUT.	1758

SOPORTES TRANSMISSION & MOTOR MOUNTS

1653

1727

1751

1752

1758

1926

6908

CONTINUACIÓN... FALCON

  28		APLICACIÓN / DESCRIPTION	DAI PARTS #
MISCELÁNEOS / AUTOMOTIVE RUBBER PARTS			
60-65		TORNILLO ESTABILIZADOR (5", 1542.4 mm)	6100
		TORNILLO ESTABILIZADOR (5", 1542.4 mm EQUIPO ORIGINAL)	6104
64-72		GOMAS PARA TIRANTE DE SUSPENSIÓN	6047
66-70		GOMAS PARA TIRANTE DE SUSPENSIÓN	6050
		TORNILLO EXCENTRICO	64600
66-80		GOMA PARA TIRANTE DE SUSPENSIÓN	64550



FIESTA

SOPORTES / TRANSMISSION & MOTOR MOUNTS			
L4 1.3	98-01	SOPORTE DE TORSIÓN TRASERO	6989
		SOPORTE PARA TRANSMISIÓN	6990
		REPUESTO PARA SOPORTE DE TRANSMISIÓN (6990)	6990-9
		SOPORTE PARA MOTOR DERECHO	6991-H



CONTINUACIÓN... FIESTA

	 28	APLICACIÓN / DESCRIPTION	DAI PARTS #
--	--	--------------------------	-------------

SOPORTES / TRANSMISSION & MOTOR MOUNTS

L4 1.3	98-01	SOPORTE PARA MOTOR DERECHO	7013
		SOPORTE PARA MOTOR DERECHO	7081

L4 1.4	98-00	SOPORTE DE TORSIÓN TRASERO	6989
		SOPORTE PARA TRANSMISIÓN	6990
		REPUESTO PARA SOPORTE DE TRANSMISIÓN (6990)	6990-9
		SOPORTE PARA MOTOR DERECHO	6991-H
		SOPORTE PARA MOTOR DERECHO	7013
		SOPORTE PARA MOTOR DERECHO	7081

L4 1.6	02-10	SOPORTE DE TORSIÓN TRASERO	6989
		SOPORTE PARA TRANSMISIÓN	6990
		REPUESTO PARA SOPORTE DE TRANSMISIÓN (6990)	6990-9
		SOPORTE PARA TRANSMISIÓN	7082
		SOPORTE PARA MOTOR TRASERO	7083
		SOPORTE PARA MOTOR DERECHO	7215
	11-16	SOPORTE PARA MOTOR DERECHO	7491-H
		SOPORTE PARA TRANSMISIÓN	7492
		SOPORTE PARA MOTOR TRASERO	7495

SOPORTES TRANSMISSION & MOTOR MOUNTS

6989

6990

6990-9

6991-H

7013

7081

7082

7083

7215

7491-H

7492

7495

CONTINUACIÓN... FIESTA

28	APLICACIÓN / DESCRIPTION	DAI PARTS #	DAI KIT PARTS #
BASES PARA AMORTIGUADOR / STRUT MOUNTS			
98-11	BASE PARA AMORTIGUADOR TRASERA IZQUIERDA Y DERECHA	1822	
	BASE PARA AMORTIGUADOR FRONTAL IZQUIERDA Y DERECHA	1829	1829-KIT
	BALERO PARA BASE DE AMORTIGUADOR FRONTAL IZQUIERDA Y DERECHA, 1829	6146	
03-10	BASE PARA AMORTIGUADOR TRASERA IZQUIERDA Y DERECHA	7353	
	BASE PARA AMORTIGUADOR FRONTAL IZQUIERDA Y DERECHA		7384-KIT



28	APLICACIÓN / DESCRIPTION	DAI PARTS #
CUBRE POLVOS / C.V. BOOTS		
03-11	CUBRE POLVO IZQUIERDO Y DERECHO LADO RUEDA	6315
	CUBRE POLVO IZQUIERDO Y DERECHO LADO CAJA	6397
	CUBRE POLVO IZQUIERDO Y DERECHO LADO CAJA (CON TRIPOIDE)	6319
	CUBRE POLVO IZQUIERDO Y DERECHO DE DIRECCIÓN HID.	63112



CONTINUACIÓN... FIESTA

	28	APLICACIÓN / DESCRIPTION	DAI PARTS #
MISCELÁNEOS / AUTOMOTIVE RUBBER PARTS			
98-11	98-01	GOMA PARA BARRA ESTABILIZADORA 3/4"	64724
		GOMA SUJETADORA DE ESCAPE	648
		GOMA SUJETADORA DE ESCAPE	649
		TOPE PARA AMORTIGUADOR TRASERO IZQUIERDO Y DERECHO	D-050
		TOPE PARA AMORTIGUADOR Y CUBRE POLVO TRASERO IZQUIERDO Y DERECHO	DAI-050-KIT
		TOPE PARA AMORTIGUADOR FRONTAL IZQUIERDO Y DERECHO	D-067
		TOPE PARA AMORTIGUADOR Y CUBRE POLVO FRONTAL IZQUIERDO Y DERECHO	DAI-067-KIT
		BUJE PARA HORQUILLA GRANDE	DAI-96FB-3A-262
00-09		BUJE PARA HORQUILLA CHICO	DAI-96FB-3063-AA
		GOMA PARA BARRA ESTABILIZADORA IZQUIERDA 7/8"	64695
		GOMA PARA BARRA ESTABILIZADORA IZQUIERDA 9/16"	64722
	TOPE PARA AMORTIGUADOR FRONTAL IZQUIERDO Y DERECHO	2009	
03-09		GOMA PARA BARRA ESTABILIZADORA IZQUIERDA	64726



CONTINUACIÓN... FIESTA

28		APLICACIÓN / DESCRIPTION	DAI PARTS #
MISCELÁNEOS / AUTOMOTIVE RUBBER PARTS			
03-04		BUJE PARA HORQUILLA INFERIOR GRANDE (SIN SOPORTE)	DAI-1408016
		BUJE PARA HORQUILLA INFERIOR CHICO	DAI-1408017
03-12		TORNILLO ESTABILIZADOR FRONTAL (LARGO BRASILEÑO)	DAI-2108002

**MISCELÁNEOS
AUTOMOTIVE RUBBER PARTS**



DAI-1408016



DAI-1408017



DAI-2108002

FIVE HUNDRED

SOPORTES / TRANSMISSION & MOTOR MOUNTS			
V6 3.0	05-07	SOPORTE PARA MOTOR FRONTAL	7542-H
		SOPORTE PARA MOTOR TRASERO	7543-H

**SOPORTES TRANSMISSION
& MOTOR MOUNTS**



7542-H



7543-H

FLEX

SOPORTES / TRANSMISSION & MOTOR MOUNTS			
V6 3.5	10-16	SOPORTE PARA MOTOR TRASERO TORQUE STRUT	7739
		SOPORTE PARA MOTOR FRONTAL TORQUE STRUT	7740

**SOPORTES TRANSMISSION
& MOTOR MOUNTS**



7739



7740



FOCUS (AMERICA)

 		APLICACIÓN / DESCRIPTION	DAI PARTS #
SOPORTES / TRANSMISSION & MOTOR MOUNTS			
L4 2.0	00-05	SOPORTE PARA MOTOR DERECHO	7072-H
		SOPORTE PARA MOTOR DERECHO	7073-H
	00-06	SOPORTE PARA TRANSMISIÓN	7000
		SOPORTE PARA MOTOR DERECHO SOHC (SOLIDO)	7063
		SOPORTE PARA MOTOR DERECHO SOHC	7063-H
		SOPORTE PARA MOTOR TRASERO	7064
		SOPORTE PARA MOTOR DERECHO DOCH (SOLIDO)	7071
		SOPORTE PARA MOTOR DERECHO DOHC	7071-H
		12-17	SOPORTE PARA MOTOR TRASERO
	SOPORTE PARA TRANSMISIÓN		7689
SOPORTE PARA MOTOR TRASERO (REFORZADO)	7759		

**SOPORTES
TRANSMISSION & MOTOR MOUNTS**

7000

7063

7063-H

7064

7071

7071-H

7072-H

7073-H

7617

7759



7689

	APLICACIÓN / DESCRIPTION	DAI PARTS #	DAI KIT PARTS #
BASES PARA AMORTIGUADOR / STRUT MOUNTS			
99-06	BASE PARA AMORTIGUADOR FRONTAL IZQUIERDA Y DERECHA	7070	

**BASES PARA AMORTIGUADOR
STRUT MOUNTS**

7070

CONTINUACIÓN... FOCUS (AMERICA)

 		APLICACIÓN / DESCRIPTION	DAI PARTS #
CUBRE POLVOS / C.V. BOOTS			
99-06		CUBRE POLVO IZQUIERDO Y DERECHO LADO RUEDA AUT.	6316
		CUBRE POLVO IZQUIERDO Y DERECHO LADO CAJA AUT.	6326
		CUBRE POLVO IZQUIERDO Y DERECHO LADO RUEDA STD.	6320
		CUBRE POLVO IZQUIERDO Y DERECHO LADO CAJA	6327
		CUBRE POLVO IZQUIERDO Y DERECHO LADO CAJA	6339
		CUBRE POLVO IZQUIERDO Y DERECHO DE DIRECCIÓN HID.	63112



MISCELÁNEOS / AUTOMOTIVE RUBBER PARTS			
99-06		GOMA SUJETADORA DE ESCAPE	6571
		GOMA PARA CAJA DE DIRECCIÓN	64741
		TOPE PARA AMORTIGUADOR TRASERO IZQUIERDO Y DERECHO	D-050
		TORNILLO ESTABILIZADOR FRONTAL (CORTO)	DAI-2108001



FOCUS (EUROPA)

 28		APLICACIÓN / DESCRIPTION	DAI PARTS #
SOPORTES / TRANSMISSION & MOTOR MOUNTS			
L4 2.0	07-11	SOPORTE PARA MOTOR DERECHO	7151-H
		SOPORTE PARA MOTOR TRASERO	7152
		SOPORTE PARA TRANSMISIÓN AUT.	7153
		SOPORTE PARA TRANSMISIÓN STD., 5 VEL.	7154
		SOPORTE PARA TRANSMISIÓN STD., 6 VEL. RT	7155
		SOPORTE PARA MOTOR TRASERO	7460
L5 2.5	07-10	SOPORTE PARA MOTOR DERECHO	7151-H
		SOPORTE PARA MOTOR TRASERO	7152
		SOPORTE PARA TRANSMISIÓN AUT.	7153
		SOPORTE PARA TRANSMISIÓN STD. 5 VEL.	7154

SOPORTES TRANSMISSION & MOTOR MOUNTS

7151-H

7152

7153

7154

7155

7460



 28		APLICACIÓN / DESCRIPTION	DAI PARTS #	DAI KIT PARTS #
BASES PARA AMORTIGUADOR / STRUT MOUNTS				
07-11	BASE PARA AMORTIGUADOR TRASERA IZQUIERDA Y DERECHA		7156	
	BASE PARA AMORTIGUADOR FRONTAL IZQUIERDA Y DERECHA		7182	

BASES PARA AMORTIGUADOR STRUT MOUNTS

7156

7182

CONTINUACIÓN... FOCUS (EUROPA)

  28		APLICACIÓN / DESCRIPTION	DAI PARTS #
MISCELÁNEOS / AUTOMOTIVE RUBBER PARTS			
07-11		TORNILLO ESTABILIZADOR FRONTAL	DAI-2113001
		BUJE PARA HORQUILLA INFERIOR GRANDE	DAI-1408057



FREESTAR

SOportes / TRANSMISSION & MOTOR MOUNTS			
V6 3.9 V6 4.2	04-07	SOPOrTE PARA MOTOR FRONTAL	7235-H
		SOPOrTE PARA MOTOR TRASERO	7236-H



  28		APLICACIÓN / DESCRIPTION	DAI PARTS #	DAI KIT PARTS #
BASES PARA AMORTIGUADOR / STRUT MOUNTS				
04-07		BASE PARA AMORTIGUADOR FRONTAL IZQUIERDA Y DERECHA		7372-KIT



  28		APLICACIÓN / DESCRIPTION	DAI PARTS #
MISCELÁNEOS / AUTOMOTIVE RUBBER PARTS			
04-08		TORNILLO ESTABILIZADOR FRONTAL	DAI-K-8702



FUSION

 		APLICACIÓN / DESCRIPTION	DAI PARTS #
SOPORTES / TRANSMISSION & MOTOR MOUNTS			
L4 1.5	13-16	SOPORTE PARA TRANSMISIÓN	7766
L4 1.6			
L4 2.0	13-17		
L4 2.5	13-16		
L4 2.3	06-12	SOPORTE PARA MOTOR TRASERO	7249
		SOPORTE PARA MOTOR DERECHO	7250-H
		SOPORTE PARA TRANSMISIÓN	7276-H
L4 2.5	10-12	REPUESTO PARA SOPORTE DE TRANSMISIÓN AUT.	7715-9
V6 3.0	06-12	SOPORTE PARA MOTOR TRASERO	7249
		SOPORTE PARA MOTOR DERECHO	7255-H
		SOPORTE PARA TRANSMISIÓN	7276-H
	08-12	SOPORTE PARA TRANSMISIÓN	7651-H
	10-12	REPUESTO PARA SOPORTE DE TRANSMISIÓN SOLIDO	7651-9
V6 3.5	08-12	SOPORTE PARA TRANSMISIÓN	7651-H
	10-12	REPUESTO PARA SOPORTE DE TRANSMISIÓN SOLIDO	7651-9

SOPORTES TRANSMISSION & MOTOR MOUNTS

7249

7250-H

7255-H

7276-H

7651-H

7651-9

7715-9

7766

		APLICACIÓN / DESCRIPTION	DAI PARTS #	DAI KIT PARTS #
BASES PARA AMORTIGUADOR / STRUT MOUNTS				
06-11		BASE PARA AMORTIGUADOR FRONTAL IZQUIERDA Y DERECHA	7597	

BASES PARA AMORTIGUADOR STRUT MOUNTS

7597

CONTINUACIÓN... FUSION

 28		APLICACIÓN / DESCRIPTION	DAI PARTS #
MISCELÁNEOS / AUTOMOTIVE RUBBER PARTS			
06-12	TORNILLO ESTABILIZADOR TRASERO		DAI-2113005
	BUJE PARA HORQUILLA INFERIOR (CURVA)		DAI-1408066
	BUJE PARA HORQUILLA INFERIOR (INTERIOR AL AMORTIGUADOR)		DAI-1408067

**MISCELÁNEOS
AUTOMOTIVE RUBBER PARTS**



DAI-2113005



DAI-1408066



DAI-1408067

Fx4

28		APLICACIÓN / DESCRIPTION	DAI PARTS #	DAI KIT PARTS #
BASES PARA AMORTIGUADOR / STRUT MOUNTS				
04-08	BASE PARA AMORTIGUADOR FRONTAL IZQUIERDA Y DERECHA (4x4)			7366-KIT

**BASES PARA AMORTIGUADOR
STRUT MOUNTS**



7366-KIT

 28		APLICACIÓN / DESCRIPTION	DAI PARTS #
MISCELÁNEOS / AUTOMOTIVE RUBBER PARTS			
04-08	BUJES PARA HORQUILLA SUPERIOR (4x4 y 4x2)		DAI-1408040

**MISCELÁNEOS
AUTOMOTIVE RUBBER PARTS**



DAI-1408040



GALAXIE

	28	APLICACIÓN / DESCRIPTION	DAI PARTS #
--	----	--------------------------	-------------

SOPORTES / TRANSMISSION & MOTOR MOUNTS

V8 4.3 V8 4.7	63-69	SOPORTE PARA TRANSMISIÓN STD. Y AUT.	1653
		SOPORTE PARA MOTOR IZQUIERDO	1926

V8 5.0 V8 5.7	65-79	SOPORTE PARA TRANSMISIÓN STD. Y AUT.	1653
		SOPORTE PARA MOTOR IZQUIERDO Y DERECHO	1654
		SOPORTE PARA TRANSMISIÓN AUT.	1707
		SOPORTE PARA TRANSMISIÓN STD.	1708
		SOPORTE PARA MOTOR IZQUIERDO Y DERECHO	1714
		SOPORTE PARA TRANSMISIÓN STD.	1760

V8 6.4	63-67	SOPORTE PARA MOTOR IZQUIERDO	1748
		SOPORTE PARA MOTOR DERECHO	1749
	63-71	SOPORTE PARA TRANSMISIÓN STD. Y AUT.	1653
		SOPORTE PARA MOTOR DERECHO (500)	6885
		SOPORTE PARA MOTOR IZQUIERDO (500)	6886

V8 5.8 V8 6.7 V8 7.0	63-71	SOPORTE PARA TRANSMISIÓN STD. Y AUT. (500)	1653
		SOPORTE PARA MOTOR DERECHO (500)	6885
	64-71	SOPORTE PARA MOTOR IZQUIERDO (500)	6886

SOPORTES TRANSMISSION & MOTOR MOUNTS

1653

1654

1707

1708

1714

1748

1749

1760

1926

6885

6886

CONTINUACIÓN... GALAXIE

  28		APLICACIÓN / DESCRIPTION	DAI PARTS #
MISCELÁNEOS / AUTOMOTIVE RUBBER PARTS			
60-64		TORNILLO ESTABILIZADOR (5", 1542.400 mm)	6100
		TORNILLO ESTABILIZADOR (5", 1542.400 mm EQUIPO ORIGINAL)	6104
65-69		GOMAS PARA TIRANTE DE SUSPENSIÓN	6048
65-78		GOMA PARA TIRANTE DE SUSPENSIÓN 500	64430
66-67		GOMAS PARA TIRANTE DE SUSPENSIÓN	6049

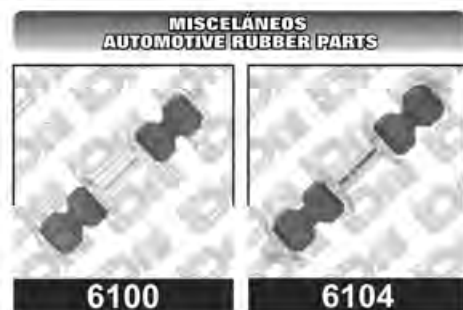

GHIA

SOPORTES / TRANSMISSION & MOTOR MOUNTS			
L4 2.3	91-94	SOPORTE PARA MOTOR DERECHO	1823
		SOPORTE PARA MOTOR FRONTAL	1872
		SOPORTE PARA MOTOR TRASERO	1873
		REPUESTO PARA SOPORTE MOTOR TRASERO (1873)	1873-9
		REPUESTO PARA SOPORTE MOTOR DERECHO (1823)	1874



CONTINUACIÓN... GHIA

 28	APLICACIÓN / DESCRIPTION	DAI PARTS #
---	--------------------------	-------------

SOPORTES / TRANSMISSION & MOTOR MOUNTS

L4 2.3	91-94	SOPORTE PARA TRANSMISIÓN AUT.	1884
		SOPORTE PARA TRANSMISIÓN AUT.	1884-H
		REPUESTO PARA SOPORTE DE AIRE ACONDICIONADO	6756
V6 3.0	92-94	SOPORTE PARA TRANSMISIÓN	1870
		REPUESTO PARA SOPORTE DE TRANSMISIÓN (1870)	1870-9
		SOPORTE PARA TRANSMISIÓN AUT.	1884
		SOPORTE PARA TRANSMISIÓN AUT.	1884-H
		REPUESTO PARA SOPORTE DE TRANSMISIÓN IZQUIERDO	1979
		REPUESTO SOPORTE PARA MOTOR DERECHO	6691
		REPUESTO SOPORTE PARA MOTOR FRONTAL (1870 Y 1871)	6919

SOPORTES TRANSMISSION & MOTOR MOUNTS

1870

1870-9

1884

1884-H

1979

6691

6756

6919

28	APLICACIÓN / DESCRIPTION	DAI PARTS #	DAI KIT PARTS #
----	--------------------------	-------------	-----------------

BASES PARA AMORTIGUADOR / STRUT MOUNTS

90-94	BASE PARA AMORTIGUADOR FRONTAL IZQUIERDA Y DERECHA	1855	
-------	--	------	--

BASES PARA AMORTIGUADOR STRUT MOUNTS

1855

CONTINUACIÓN... GUIA

28	APLICACIÓN / DESCRIPTION	DAI PARTS #	DAI KIT PARTS #
BASES PARA AMORTIGUADOR / STRUT MOUNTS			
91-94	BASE PARA AMORTIGUADOR FRONTAL IZQUIERDA Y DERECHA	6784	6784-KIT
	BASE PARA AMORTIGUADOR TRASERA IZQUIERDA Y DERECHA	6715	6715-KIT
	BALERO PARA BASES DE AMORTIGUADOR 1855, 6784 Y 6784-KIT	6138	



28	APLICACIÓN / DESCRIPTION	DAI PARTS #
CUBRE POLVOS / C.V. BOOTS		
90-94	CUBRE POLVO IZQUIERDO Y DERECHO LADO CAJA	6380
	CUBRE POLVO DERECHO LADO CAJA	6391
	CUBRE POLVO IZQUIERDO LADO RUEDA	6392
	CUBRE POLVO IZQUIERDO Y DERECHO DE DIRECCIÓN	6399



CONTINUACIÓN... GHIA

 28	APLICACIÓN / DESCRIPTION	DAI PARTS #
MISCELÁNEOS / AUTOMOTIVE RUBBER PARTS		
90-94	BUJE PARA HORQUILLA INFERIOR INTERIOR (BRAZO) (2x2)	DAI-K-8436

GRANADA



SOPORTES / TRANSMISSION & MOTOR MOUNTS			
L6 3.3 L6 4.1	71-77	SOPORTE PARA MOTOR IZQUIERDO Y DERECHO	6866
V6 3.8 V6 4.2 V6 5.0	81-84	SOPORTE PARA MOTOR IZQUIERDO	6786
		SOPORTE PARA MOTOR DERECHO	6788
		SOPORTE PARA MOTOR IZQUIERDO	6796
		SOPORTE PARA MOTOR DERECHO	6797



 28	APLICACIÓN / DESCRIPTION	DAI PARTS #	DAI KIT PARTS #
BASES PARA AMORTIGUADOR / STRUT MOUNTS			
81-82	REPUESTO BASE DE AMORTIGUADOR FRONTAL IZQUIERDA Y DERECHA		6729-KIT



CONTINUACIÓN... GRANADA

	 28	APLICACIÓN / DESCRIPTION	DAI PARTS #
MISCELÁNEOS / AUTOMOTIVE RUBBER PARTS			
	81-82	TOPE PARA AMORTIGUADOR FRONTAL IZQUIERDO Y DERECHO	D-0620



GRAND MARQUIS

SOPORTES / TRANSMISSION & MOTOR MOUNTS			
V8 4.6	98-02	SOPORTE PARA TRANSMISIÓN	6622
		SOPORTE PARA MOTOR DERECHO	6701
		SOPORTE PARA MOTOR IZQUIERDO	6702
V8 5.0 V8 5.8	79-91	SOPORTE PARA MOTOR IZQUIERDO	6620
		SOPORTE PARA MOTOR DERECHO	6621
		SOPORTE PARA TRANSMISIÓN	6622
V8 351	78-84	SOPORTE PARA MOTOR IZQUIERDO	6620
		SOPORTE PARA MOTOR DERECHO	6621
		SOPORTE PARA TRANSMISIÓN	6622



CONTINUACIÓN... GRAND MARQUIS

		APLICACIÓN / DESCRIPTION	DAI PARTS #
MISCELÁNEOS / AUTOMOTIVE RUBBER PARTS			
	65-78	GOMA PARA TIRANTE DE SUSPENSIÓN	64430
	83-02	TORNILLO ESTABILIZADOR (10", 254.000 mm)	6103
		TORNILLO ESTABILIZADOR (10", 243 mm EQUIPO ORIGINAL)	6107

IKON

SOPORTES / TRANSMISSION & MOTOR MOUNTS			
L4 1.6	00-08	SOPORTE DE TORSIÓN TRASERO	6989
		SOPORTE PARA TRANSMISIÓN	6990
		REPUESTO PARA SOPORTE DE TRANSMISIÓN (6990)	6990-9
	11-15	SOPORTE PARA MOTOR DERECHO	7013
		SOPORTE PARA TRANSMISIÓN	7082
		SOPORTE PARA MOTOR TRASERO	7083
		SOPORTE PARA MOTOR DERECHO	7461-H



CONTINUACIÓN... IKON

28	APLICACIÓN / DESCRIPTION	DAI PARTS #	DAI KIT PARTS #
BASES PARA AMORTIGUADOR / STRUT MOUNTS			
98-11	BASE PARA AMORTIGUADOR TRASERA IZQUIERDA Y DERECHA	1822	
	BASE PARA AMORTIGUADOR FRONTAL IZQUIERDA Y DERECHA	1829	1829-KIT
	BALERO PARA BASE DE AMORTIGUADOR FRONTAL IZQUIERDA Y DERECHO 1829, 1829-KIT	6146	



28	APLICACIÓN / DESCRIPTION	DAI PARTS #
CUBRE POLVOS / C.V. BOOTS		
98-11	CUBRE POLVO IZQUIERDO Y DERECHO LADO RUEDA	6315
	CUBRE POLVO IZQUIERDO Y DERECHO LADO CAJA	6397
	CUBRE POLVO IZQUIERDO Y DERECHO LADO CAJA (CON TRIPOIDE)	6319
	CUBRE POLVO IZQUIERDO Y DERECHO DE DIRECCIÓN HID.	63112



CONTINUACIÓN... IKON

28		APLICACIÓN / DESCRIPTION	DAI PARTS #
MISCELÁNEOS / AUTOMOTIVE RUBBER PARTS			
98-11		GOMA SUJETADORA DE ESCAPE	648
		GOMA SUJETADORA DE ESCAPE	649
		TOPE PARA AMORTIGUADOR Y CUBRE POLVO TRASERO IZQUIERDO Y DERECHO	DAI-050-KIT
		TOPE PARA AMORTIGUADOR Y CUBRE POLVO FRONTAL IZQUIERDO Y DERECHO	DAI-067-KIT
		TOPE PARA AMORTIGUADOR FRONTAL IZQUIERDO Y DERECHO	DAI-067
		TORNILLO ESTABILIZADOR FRONTAL (CORTO)	DAI-2108001
98-15		BUJE PARA HORQUILLA INFERIOR GRANDE	DAI-96FB-3A-262
		BUJE PARA HORQUILLA INFERIOR CHICO	DAI-96FB-3063-AA
12-13		BUJE PARA HORQUILLA INFERIOR GRANDE (SIN SOPORTE)	DAI-1408016
12-14		BUJE PARA HORQUILLA INFERIOR CHICO	DAI-1408017
12-15		TORNILLO ESTABILIZADOR FRONTAL (LARGO INDIA)	DAI-2108002

**MISCELÁNEOS
AUTOMOTIVE RUBBER PARTS**

D-067

648

649

DAI-050-KIT

DAI-067-KIT

DAI-1408016

DAI-1408017

DAI-2108001

DAI-2108002

DAI-96FB-3A-262

DAI-96FB-3063-AA

KA

 		APLICACIÓN / DESCRIPTION	DAI PARTS #
SOPORTES / TRANSMISSION & MOTOR MOUNTS			
L4 1.6	01-08	SOPORTE PARA MOTOR TRASERO	6999
		SOPORTE PARA TRANSMISIÓN FRONTAL	7001
		SOPORTE PARA TRANSMISIÓN	7002
		SOPORTE PARA MOTOR DERECHO	7081

SOPORTES TRANSMISSION & MOTOR MOUNTS



6999



7001



7002



7081

	APLICACIÓN / DESCRIPTION	DAI PARTS #	DAI KIT PARTS #
BASES PARA AMORTIGUADOR / STRUT MOUNTS			
01-08	BASE PARA AMORTIGUADOR FRONTAL IZQUIERDA Y DERECHA	1829	1829-KIT
	BALERO PARA BASE DE AMORTIGUADOR FRONTAL IZQUIERDO Y DERECHO 1829	6146	

BASES PARA AMORTIGUADOR STRUT MOUNTS





1829



1829-KIT



6146

 		APLICACIÓN / DESCRIPTION	DAI PARTS #
CUBRE POLVOS / C.V. BOOTS			
	01-08	CUBRE POLVO IZQUIERDO Y DERECHO LADO CAJA (CON TRIPOIDE)	6319

CUBRE POLVO C.V. BOOTS



6319



6319



CONTINUACIÓN... KA

	28	APLICACIÓN // DESCRIPTION	DAI PARTS #
CUBRE POLVOS / C.V. BOOTS			
01-08		CUBRE POLVO DERECHO LADO CAJA (CON TRIPOIDE)	6386



MISCELÁNEOS / AUTOMOTIVE RUBBER PARTS			
	01-08	TOPE PARA AMORTIGUADOR TRASERO IZQUIERDO Y DERECHO	D-050
		GOMA PARA BARRA ESTABILIZADORA 9/16"	64722
		BUJE PARA HORQUILLA INFERIOR GRANDE	DAI-1408033
		BUJE PARA HORQUILLA INFERIOR CHICO	DAI-1408034

LOBO

SOPORTES / TRANSMISSION & MOTOR MOUNTS			
V8 4.6 V8 5.4	06-12	SOPORTE PARA MOTOR IZQUIERDO	7382-H
		SOPORTE PARA MOTOR DERECHO	7383-H





CONTINUACIÓN... LOBO

  28		APLICACIÓN / DESCRIPTION	DAI PARTS #
SOPORTES / TRANSMISSION & MOTOR MOUNTS			
V8 5.4	99-06	SOPORTE PARA MOTOR IZQUIERDO (TRITON)	7115
		SOPORTE PARA MOTOR DERECHO (TRITON)	7116
V8 4.6	05-10	SOPORTE PARA MOTOR IZQUIERDO	7580-H
		SOPORTE PARA MOTOR DERECHO	7601-H



 28		APLICACIÓN / DESCRIPTION	DAI PARTS #	DAI KIT PARTS #
BASES PARA AMORTIGUADOR / STRUT MOUNTS				
04-08		BASE PARA AMORTIGUADOR FRONTAL IZQUIERDA Y DERECHA (4X4)		7366-KIT



  28		APLICACIÓN / DESCRIPTION	DAI PARTS #
MISCELÁNEOS / AUTOMOTIVE RUBBER PARTS			
	80-96	GOMA PARA TIRANTE DE SUSPENSIÓN	64350
	81-90	GOMA PARA TIRANTE DE SUSPENSIÓN	64370



CONTINUACIÓN... LOBO

	 28	APLICACIÓN / DESCRIPTION	DAI PARTS #
MISCELÁNEOS / AUTOMOTIVE RUBBER PARTS			
	97-03	GOMA SUJETADORA DE ESCAPE	6567
		GOMA PARA BARRA ESTABILIZADORA (4X4)	64728
	97-05	TOPE PARA AMORTIGUADOR FRONTAL IZQUIERDO Y DERECHO	2008
	00-08	GOMAS PARA AMORTIGUADOR	2015
	04-08	BUJES PARA HORQUILLA SUPERIOR (4X2 Y 4X4)	DAI-1408040

LTD



 28	APLICACIÓN / DESCRIPTION	DAI PARTS #	DAI KIT PARTS #
BASES PARA AMORTIGUADOR / STRUT MOUNTS			
83-86	REPUESTO BASE DE AMORTIGUADOR FRONTAL IZQUIERDA Y DERECHA		6729-KIT



	 28	APLICACIÓN / DESCRIPTION	DAI PARTS #
MISCELÁNEOS / AUTOMOTIVE RUBBER PARTS			
	65-78	GOMA PARA TIRANTE DE SUSPENSIÓN	64430



MAVERICK

 		APLICACIÓN / DESCRIPTION	DAI PARTS #
SOPORTES / TRANSMISSION & MOTOR MOUNTS			
V6 4.7 V6 5.0	71-77	SOPORTE PARA TRANSMISIÓN STD. Y AUT.	1725
		SOPORTE PARA TRANSMISIÓN STD. Y AUT.	1773



MISCELÁNEOS / AUTOMOTIVE RUBBER PARTS			
	70-77	GOMA PARA TIRANTE DE SUSPENSIÓN	64550
		TORNILLO EXCENTRICO	64600
	75-77	TORNILLO ESTABILIZADOR (5", 154.24 mm)	6100
		TORNILLO ESTABILIZADOR (5", 154.24 mm EQUIPO ORIGINAL)	6104
	78-89	COPLÉ PARA DIRECCIÓN (SINFÍN DE .725" 2 PERNOS UNIVERSALES REPUESTO 626)	611
		GALLETAS PARA DIRECCIÓN STD. Y HID. (2 PERNOS DELGADOS COMPLETO 611)	626

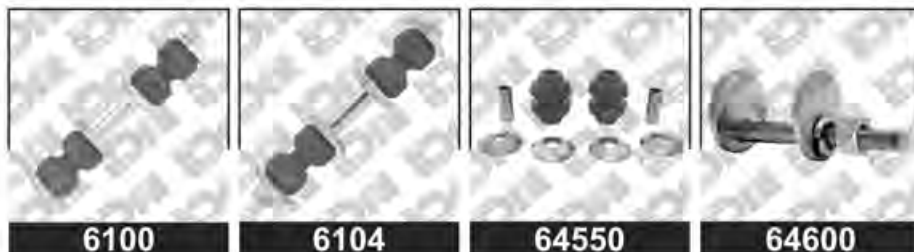

MICROBUS

MISCELÁNEOS / AUTOMOTIVE RUBBER PARTS			
	80-98	BUJE PARA EJE (PARALELO)	DAI-K-8300
		GOMA PARA TIRANTE DE SUSPENSIÓN	64350



MODIFICADOS

 28	APLICACIÓN / DESCRIPTION	DAI PARTS #
MISCELÁNEOS / AUTOMOTIVE RUBBER PARTS		
79-92	GOMA PARA TIRANTE DE SUSPENSIÓN	64360

**MISCELÁNEOS
AUTOMOTIVE RUBBER PARTS**

64360
MONDEO
SOPORTES / TRANSMISSION & MOTOR MOUNTS

L4 2.0	01-07	SOPORTE PARA TRANSMISIÓN	7185
		SOPORTE PARA MOTOR TRASERO	7186
		SOPORTE PARA MOTOR DERECHO	7198-H
V6 2.5 V6 3.0	01-07	SOPORTE PARA TRANSMISIÓN	7185
		SOPORTE PARA MOTOR TRASERO	7186

**SOPORTES TRANSMISSION
& MOTOR MOUNTS**

7185

7186

7198-H



 28	APLICACIÓN / DESCRIPTION	DAI PARTS #	DAI KIT PARTS #
BASES PARA AMORTIGUADOR / STRUT MOUNTS			
02-07	BASE PARA AMORTIGUADOR FRONTAL IZQUIERDA Y DERECHA	6992	
	BASE PARA AMORTIGUADOR TRASERA IZQUIERDA Y DERECHA	6993	

**BASES PARA AMORTIGUADOR
STRUT MOUNTS**

6992

6993

CONTINUACIÓN... MONDEO

	 28	APLICACIÓN / DESCRIPTION	DAI PARTS #
CUBRE POLVOS / C.V. BOOTS			
	01-07	CUBRE POLVO IZQUIERDO Y DERECHO LADO RUEDA	6316
		CUBRE POLVO IZQUIERDO Y DERECHO LADO CAJA	6327
		CUBRE POLVO IZQUIERDO Y DERECHO DE DIRECCIÓN HID.	63112



MISCELÁNEOS / AUTOMOTIVE RUBBER PARTS

	01-07	TOPE PARA AMORTIGUADOR FRONTAL IZQUIERDO Y DERECHO	D-097
	02-07	TORNILLO ESTABILIZADOR TRASERO	DAI-2108003
		TORNILLO ESTABILIZADOR FRONTAL	DAI-2108005



MUSTANG

 28		APLICACIÓN / DESCRIPTION	DAI PARTS #
SOPORTES / TRANSMISSION & MOTOR MOUNTS			
L6 3.3	79-82	SOPORTE PARA TRANSMISIÓN	1845
		SOPORTE PARA TRANSMISIÓN STD.	1846
V6 2.8	79-80	SOPORTE PARA TRANSMISIÓN	1845
		REPUESTO PARA SOPORTE MOTOR IZQUIERDO (1862)	1847
		SOPORTE PARA MOTOR IZQUIERDO	1862
		REPUESTO PARA SOPORTE MOTOR DERECHO (1863)	1848
		SOPORTE PARA MOTOR DERECHO	1863
V6 3.8	81-84	SOPORTE PARA MOTOR IZQUIERDO	6786
		SOPORTE PARA MOTOR DERECHO	6788
		SOPORTE PARA MOTOR IZQUIERDO	6796
		SOPORTE PARA MOTOR DERECHO	6797
	96-98	SOPORTE PARA TRANSMISIÓN	1845
	96-04	SOPORTE PARA MOTOR DERECHO	7462
V6 4.2 V8 5.0	81-84	SOPORTE PARA MOTOR IZQUIERDO	6786
		SOPORTE PARA MOTOR DERECHO	6788
		SOPORTE PARA MOTOR IZQUIERDO	6796
		SOPORTE PARA MOTOR DERECHO	6797
V8 4.2	63-69	SOPORTE PARA TRANSMISIÓN STD. Y AUT.	1653
		SOPORTE PARA MOTOR IZQUIERDO	1926
V8 4.6	96-98	SOPORTE PARA TRANSMISIÓN	1845

SOPORTES TRANSMISSION & MOTOR MOUNTS

1653

1845

1846

1847

1848

1862

1863

1926

6786



6788

6796

6797

7462

CONTINUACIÓN... MUSTANG

 		APLICACIÓN / DESCRIPTION	DAI PARTS #
SOPORTES / TRANSMISSION & MOTOR MOUNTS			
V8 4.7	63-69	SOPORTE PARA TRANSMISIÓN STD. Y AUT.	1653
		SOPORTE PARA MOTOR IZQUIERDO	1926
	66-74	SOPORTE PARA TRANSMISIÓN STD. Y AUT.	1722
		SOPORTE PARA TRANSMISIÓN STD. Y AUT.	1758
	70-74	SOPORTE PARA MOTOR IZQUIERDO Y DERECHO	1727
V8 5.0	66-77	SOPORTE PARA TRANSMISIÓN STD. Y AUT.	1722
		SOPORTE PARA TRANSMISIÓN STD. Y AUT.	1758
	70-74	SOPORTE PARA MOTOR IZQUIERDO Y DERECHO	1727
		SOPORTE PARA MOTOR IZQUIERDO Y DERECHO	1772
	78-85	SOPORTE PARA TRANSMISIÓN	1845
		SOPORTE PARA TRANSMISIÓN STD.	1846
		REPUESTO PARA SOPORTE MOTOR IZQUIERDO (1862)	1847
		REPUESTO PARA SOPORTE MOTOR DERECHO (1863)	1848
		SOPORTE PARA MOTOR IZQUIERDO	1862
		SOPORTE PARA MOTOR DERECHO	1863
V8 5.7	74-77	SOPORTE PARA TRANSMISIÓN STD. Y AUT.	1722
		SOPORTE PARA TRANSMISIÓN STD. Y AUT.	1758
		SOPORTE PARA MOTOR IZQUIERDO Y DERECHO	1772
V8 7.5	66-70	SOPORTE PARA TRANSMISIÓN STD. Y AUT.	1722
		SOPORTE PARA TRANSMISIÓN STD. Y AUT.	1758



CONTINUACIÓN... MUSTANG

28	APLICACIÓN / DESCRIPTION	DAI PARTS #	DAI KIT PARTS #
BASES PARA AMORTIGUADOR / STRUT MOUNTS			
85-06	REPUESTO BASE DE AMORTIGUADOR FRONTAL IZQUIERDA Y DERECHA		6729-KIT



28	APLICACIÓN / DESCRIPTION	DAI PARTS #
CUBRE POLVOS / C.V. BOOTS		
74-78	CUBRE POLVO IZQUIERDO Y DERECHO DE DIRECCIÓN HID.	6341
79-84	CUBRE POLVO IZQUIERDO Y DERECHO DE DIRECCIÓN HID.	6377



MISCELÁNEOS / AUTOMOTIVE RUBBER PARTS			
	CUBRE POLVO PARA PALANCA DE VELOCIDADES	6084	
	CUBRE POLVO PARA PALANCA DE VELOCIDADES (SIN PLACA DE ACERO)	6551	
67-73	GOMA PARA TIRANTE DE SUSPENSIÓN (M.S. STD. Y P.S. HID.)	64550	
	TORNILLO EXCENTRICO	64600	
1967	TORNILLO ESTABILIZADOR (5", 1542.400 mm)	6100	
	TORNILLO ESTABILIZADOR (5", 1542.4 mm EQUIPO ORIGINAL)	6104	
74-78	GOMA PARA TIRANTE DE SUSPENSIÓN (P.S.STD.)	64560	

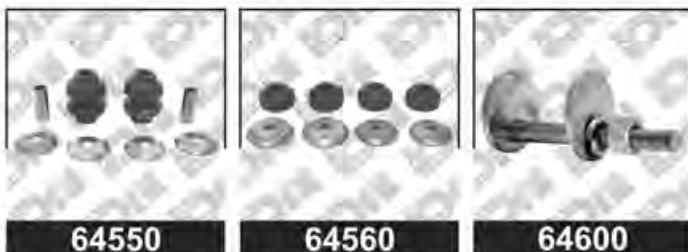

CONTINUACIÓN... MUSTANG

 		APLICACIÓN / DESCRIPTION	DAI PARTS #
MISCELÁNEOS / AUTOMOTIVE RUBBER PARTS			
78-89		COPLE PARA DIRECCIÓN (SINFÍN DE .725" 2 PERNOS UNIVERSALES REPUESTO 626)	611
		GALLETAS PARA DIRECCIÓN STD. Y HID. (2 PERNOS DELGADOS COMPLETO 611)	626
79-83		GOMA PARA BARRA ESTABILIZADORA	6412
		GOMA SUJETADORA DE ESCAPE	70
		TOPE PARA AMORTIGUADOR FRONTAL IZQUIERDO Y DERECHO	D-0620
79-04		TORNILLO ESTABILIZADOR (10", 254.000 mm)	6103
		TORNILLO ESTABILIZADOR (243 mm EQUIPO ORIGINAL)	6107
85-04		TOPE PARA AMORTIGUADOR FRONTAL TRASERO IZQUIERDO Y DERECHO	D-0621
94-99		TOPE PARA AMORTIGUADOR FRONTAL IZQUIERDO Y DERECHO	D-0622
94-04		TOPE PARA AMORTIGUADOR FRONTAL TRASERO IZQUIERDO Y DERECHO (COBRA)	D-0621
05-14		TORNILLO ESTABILIZADOR FRONTAL	DAI-K-8702



MYSTIQUE

	28	APLICACIÓN / DESCRIPTION	DAI PARTS #
--	----	--------------------------	-------------

SOPORTES / TRANSMISSION & MOTOR MOUNTS

L4 2.0	95-00	REPUESTO PARA SOPORTE DE MOTOR FRONTAL (6705)	6705-9
		SOPORTE PARA MOTOR TRASERO	6714
		REPUESTO PARA SOPORTE MOTOR TRASERO (6714)	6714-9
		REPUESTO PARA SOPORTE DE MOTOR FRONTAL	6704-9
		SOPORTE PARA TRANSMISIÓN AUT.	6706
		SOPORTE PARA TRANSMISIÓN STD.	6707
		REPUESTO PARA SOPORTE DE TRANSMISIÓN STD. Y AUT. (6706, 6707, 6940 Y 6941)	6707-9
		SOPORTE PARA TRANSMISIÓN	6940
		REPUESTO PARA SOPORTE DE TRANSMISIÓN	6941
		SOPORTE PARA MOTOR FRONTAL STD. (TIPO ORIGINAL)	6856
SOPORTE PARA MOTOR FRONTAL AUT. (TIPO ORIGINAL)	6857		

SOPORTES TRANSMISSION & MOTOR MOUNTS

6704-9

6705-9

6706

6707

6707-9

6714

V6 2.5	95-00	REPUESTO PARA SOPORTE DE MOTOR FRONTAL	6705-9
		REPUESTO PARA SOPORTE DE MOTOR FRONTAL	6704-9
		SOPORTE PARA MOTOR TRASERO	6714
		REPUESTO PARA SOPORTE MOTOR TRASERO (6714)	6714-9
		SOPORTE PARA TRANSMISIÓN AUT.	6706
		SOPORTE PARA TRANSMISIÓN STD.	6707

6714-9

6856

6857

6940

6941

CONTINUACIÓN... MYSTIQUE

 		APLICACIÓN / DESCRIPTION	DAI PARTS #
SOPORTES / TRANSMISSION & MOTOR MOUNTS			
V6 2.5	95-00	SOPORTE PARA TRANSMISIÓN	6940
		REPUESTO PARA SOPORTE DE TRANSMISIÓN	6941
		REPUESTO PARA SOPORTE DE TRANSMISIÓN STD. Y AUT. (6706, 6707, 6940 Y 6941)	6707-9



		APLICACIÓN / DESCRIPTION	DAI PARTS #	DAI KIT PARTS #
BASES PARA AMORTIGUADOR / STRUT MOUNTS				
95-01		BASE PARA AMORTIGUADOR FRONTAL IZQUIERDA Y DERECHA	1829	1829-KIT
		BASE PARA AMORTIGUADOR FRONTAL IZQUIERDA Y DERECHA	6753	6753-KIT
		BASE PARA AMORTIGUADOR TRASERA IZQUIERDA Y DERECHA	6754	6754-KIT
		BALERO PARA BASE DE AMORTIGUADOR FRONTAL IZQUIERDO Y DERECHO	6146	



CONTINUACIÓN... MYSTIQUE

 28		APLICACIÓN / DESCRIPTION	DAI PARTS #
CUBRE POLVOS / C.V. BOOTS			
V6 2.5	95-01	CUBRE POLVO IZQUIERDO Y DERECHO LADO RUEDA	6315
		CUBRE POLVO IZQUIERDO Y DERECHO LADO RUEDA	6337



MISCELÁNEOS / AUTOMOTIVE RUBBER PARTS			
	95-01	GOMA PARA CREMALLERA DE DIRECCIÓN HID. (DERECHA PAR 720)	719
		GOMA PARA CREMALLERA DE DIRECCIÓN HID. (IZQUIERDA PAR 719)	720
		TORNILLO ESTABILIZADOR FRONTAL	DAI-93BB-3B-438CA

DAI-93BB-3B-438CA

POLICE INTERCEPTOR UTILITY

SOPORTES / TRANSMISSION & MOTOR MOUNTS			
V6 3.5	14-16	SOPORTE PARA MOTOR TRASERO TORQUE STRUT	7739
		SOPORTE PARA MOTOR FRONTAL TORQUE STRUT	7740
V6 3.7	2015	SOPORTE PARA MOTOR TRASERO TORQUE STRUT	7739
		SOPORTE PARA MOTOR FRONTAL TORQUE STRUT	7740



PINTO

		APLICACIÓN / DESCRIPTION	DAI PARTS #
MISCELÁNEOS / AUTOMOTIVE RUBBER PARTS			
	71-80	GOMA PARA TIRANTE DE SUSPENSIÓN	64560





PROBE

SOPORTES / TRANSMISSION & MOTOR MOUNTS			
L4 2.0	93-97	SOPORTE PARA TRANSMISIÓN	6966
L4 2.2	89-92	SOPORTE PARA MOTOR TRASERO	6957
		SOPORTE PARA MOTOR TRASERO	6958
		SOPORTE PARA MOTOR TRASERO AUT.	6959
		SOPORTE PARA TRANSMISIÓN	6960
		SOPORTE PARA TRANSMISIÓN	6861
		SOPORTE PARA MOTOR TRASERO	6963
		SOPORTE PARA TRANSMISIÓN STD.	6964
		SOPORTE PARA MOTOR FRONTAL	6967
V6 3.0	90-92	SOPORTE PARA MOTOR FRONTAL	6967



RANGER

 		APLICACIÓN / DESCRIPTION	DAI PARTS #
SOPORTES / TRANSMISSION & MOTOR MOUNTS			
L4 2.0	85-87	SOPORTE PARA MOTOR DERECHO	6891
		SOPORTE PARA MOTOR IZQUIERDO	6892
	85-89	SOPORTE PARA TRANSMISIÓN	6923
	85-97	SOPORTE PARA TRANSMISIÓN	6890
		SOPORTE PARA TRANSMISIÓN	6924
L4 2.3	85-87	SOPORTE PARA MOTOR DERECHO	6891
		SOPORTE PARA MOTOR IZQUIERDO	6892
	85-89	SOPORTE PARA TRANSMISIÓN	6923
	88-97	SOPORTE PARA MOTOR IZQUIERDO Y DERECHO	6893-H
	90-11	SOPORTE PARA TRANSMISIÓN	6890
		SOPORTE PARA TRANSMISIÓN	6924
02-12	SOPORTE PARA MOTOR DERECHO	6884	
L4 2.5	97-01	SOPORTE PARA TRANSMISIÓN	6890
		SOPORTE PARA TRANSMISIÓN	6924
	98-01	SOPORTE PARA MOTOR IZQUIERDO Y DERECHO	7779
V6 2.9	86-92	SOPORTE PARA TRANSMISIÓN	6890
		SOPORTE PARA MOTOR DERECHO	6891
		SOPORTE PARA MOTOR IZQUIERDO	6892
		SOPORTE PARA TRANSMISIÓN	6924
		SOPORTE PARA MOTOR IZQUIERDO	6948

SOPORTES TRANSMISSION & MOTOR MOUNTS

6884

6890

6891

6892

6893-H

6923

6924

6948

7779

CONTINUACIÓN... RANGER

	 28	APLICACIÓN / DESCRIPTION	DAI PARTS #
---	--	--------------------------	-------------

SOPORTES / TRANSMISSION & MOTOR MOUNTS

V6 3.0	91-94	SOPORTE PARA MOTOR IZQUIERDO	6892
	91-97	SOPORTE PARA MOTOR DERECHO (4X4)	6911
		SOPORTE PARA MOTOR IZQUIERDO (4X4)	6948
	98-01	SOPORTE PARA MOTOR DERECHO (4X4)	6884
		SOPORTE PARA MOTOR IZQUIERDO (4X4)	7184
	98-08	SOPORTE PARA TRANSMISIÓN	6890
		SOPORTE PARA TRANSMISIÓN	6924
99-07	SOPORTE PARA MOTOR IZQUIERDO Y DERECHO	7779	

V6 4.0	90-97	SOPORTE PARA MOTOR DERECHO (TRACCIÓN TRASERA Y 4X4)	6891
		SOPORTE PARA MOTOR IZQUIERDO (TRACCIÓN TRASERA Y 4X4)	6892
		SOPORTE PARA MOTOR DERECHO (4X4)	6948
	98-07	SOPORTE PARA MOTOR DERECHO (4X4)	6884
		SOPORTE PARA MOTOR IZQUIERDO (4X4)	7184
	98-11	SOPORTE PARA TRANSMISIÓN	6890
		SOPORTE PARA TRANSMISIÓN	6924
	99-11	SOPORTE PARA MOTOR IZQUIERDO Y DERECHO	7779

SOPORTES TRANSMISSION & MOTOR MOUNTS



6884



6890



6891



6892



6911



6924



6948



7184



7779

NUEVO



CONTINUACIÓN... RANGER

 28	APLICACIÓN / DESCRIPTION	DAI PARTS #
CUBRE POLVOS / C.V. BOOTS		
98-12	CUBRE POLVO IZQUIERDO Y DERECHO DE DIRECCIÓN HID.	63112



MISCELÁNEOS / AUTOMOTIVE RUBBER PARTS

83-97	GOMA PARA TIRANTE DE SUSPENSIÓN	64350
91-08	COPLER PARA DIRECCIÓN CHICO 2 5/8" (SINFÍN DE .725" AMERICANAS)	607
	COPLER PARA DIRECCIÓN STD. Y HID. COPLER CHICO 2 5/8" (SINFÍN DE .700" IMPORTADOS)	616
	GALLETA PARA DIRECCIÓN (4 PERNOS COPLER CHICO 2 5/8" COMPLETO 607 Y 617 NACIONALES Y AMERICANOS)	625
98-12	GOMA PARA BARRA ESTABILIZADOR 1" (4X2 Y 4X4)	64716



SABLE

 		APLICACIÓN / DESCRIPTION	DAI PARTS #
SOPORTES / TRANSMISSION & MOTOR MOUNTS			
V6 3.0	86-90	SOPORTE PARA MOTOR TRASERO DERECHO	6910
	89-06	SOPORTE PARA TRANSMISIÓN	7271-H
	91-92	SOPORTE PARA MOTOR FRONTAL DERECHO	6895-H
	91-99	SOPORTE PARA MOTOR FRONTAL DERECHO	6846-H
	94-95	SOPORTE PARA MOTOR FRONTAL DERECHO	6847-H
	96-03	SOPORTE PARA MOTOR TRASERO DERECHO	7183
	00-03	SOPORTE DE TORSIÓN TRASERO	7227
	01-06	SOPORTE PARA MOTOR TRASERO DERECHO	7270
V6 3.2	94-95	SOPORTE PARA TRANSMISIÓN	7271-H
V6 3.4	96-99	SOPORTE PARA MOTOR TRASERO DERECHO	7183
		SOPORTE PARA MOTOR FRONTAL	7240-H
		SOPORTE PARA TRANSMISIÓN	7271-H



		APLICACIÓN / DESCRIPTION	DAI PARTS #	DAI KIT PARTS #
BASES PARA AMORTIGUADOR / STRUT MOUNTS				
86-95		BASE PARA AMORTIGUADOR FRONTAL IZQUIERDA Y DERECHA	6730	6730-KIT



CONTINUACIÓN... SABLE

28	APLICACIÓN / DESCRIPTION	DAI PARTS #	DAI KIT PARTS #
BASES PARA AMORTIGUADOR / STRUT MOUNTS			
86-07	BASE PARA AMORTIGUADOR TRASERA IZQUIERDA Y DERECHA	6733	6733-KIT
	BASE PARA AMORTIGUADOR FRONTAL IZQUIERDA Y DERECHA		7286-KIT

7286-KIT



28	APLICACIÓN / DESCRIPTION	DAI PARTS #
CUBRE POLVOS / C.V. BOOTS		
86-95	CUBRE POLVO IZQUIERDO Y DERECHO LADO RUEDA	6378
	CUBRE POLVO IZQUIERDO Y DERECHO LADO CAJA	6380
	CUBRE POLVO IZQUIERDO Y DERECHO LADO CAJA	6391

6391

MISCELÁNEOS / AUTOMOTIVE RUBBER PARTS		
86-95	TORNILLO ESTABILIZADOR FRONTAL (MISMO K-8639)	DAI-K-8702
	BUJE PARA HORQUILLA INFERIOR	DAI-K-8452-A



CONTINUACIÓN... SABLE

 		APLICACIÓN / DESCRIPTION	DAI PARTS #
MISCELÁNEOS / AUTOMOTIVE RUBBER PARTS			
96-07		TOPE PARA AMORTIGUADOR TRASERO IZQUIERDO Y DERECHO	D-0619
		TORNILLO ESTABILIZADOR FRONTAL IZQUIERDO	DAI-K-8734



SERIES E

SOPORTES / TRANSMISSION & MOTOR MOUNTS			
V8 7.5	73-82	SOPORTE PARA MOTOR IZQUIERDO Y DERECHO	6917
	75-88	SOPORTE PARA MOTOR IZQUIERDO Y DERECHO	6927



SERIES F

SOPORTES / TRANSMISSION & MOTOR MOUNTS			
L6 4.9	85-96	SOPORTE PARA TRANSMISIÓN	1896
		SOPORTE PARA MOTOR IZQUIERDO (4WD)	6764
		SOPORTE PARA MOTOR DERECHO (4WD)	6769
V8 5.8 V8 6.6	77-82	SOPORTE PARA TRANSMISIÓN	1719



TAURUS

	28	APLICACIÓN / DESCRIPTION	DAI PARTS #
SOPORTES / TRANSMISSION & MOTOR MOUNTS			
L4 2.5	86-97	SOPORTE PARA TRANSMISIÓN	6877
		SOPORTE PARA TRANSMISIÓN	6878
V6 3.0	86-90	SOPORTE PARA MOTOR TRASERO DERECHO	6910
	94-95	SOPORTE PARA MOTOR FRONTAL DERECHO	6847-H
	96-99	SOPORTE PARA MOTOR FRONTAL DERECHO	6846-H
	96-03	SOPORTE PARA MOTOR TRASERO DERECHO	7183
	00-03	SOPORTE DE TORSIÓN TRASERO	7227
	08-09	SOPORTE PARA MOTOR FRONTAL	7542-H
SOPORTE PARA MOTOR TRASERO		7543-H	
V6 3.4	96-99	SOPORTE PARA MOTOR FRONTAL	7240-H
		SOPORTE PARA MOTOR TRASERO DERECHO	7183
V6 3.5	10-16	SOPORTE PARA MOTOR TRASERO TORQUE STRUT	7739
		SOPORTE PARA MOTOR FRONTAL TORQUE STRUT	7740
V6 3.8	88-95	SOPORTE PARA MOTOR TRASERO	6674
		SOPORTE PARA MOTOR TRASERO	6674-H

SOPORTES TRANSMISSION & MOTOR MOUNTS

6674

6674-H

6846-H

6847-H

6877

6878

6910

7183

7227

7240-H



7542-H

7543-H

7739

7740



CONTINUACIÓN... TAURUS

 		APLICACIÓN / DESCRIPTION	DAI PARTS #
SOPORTES / TRANSMISSION & MOTOR MOUNTS			
V6 3.8	88-95	SOPORTE PARA MOTOR FRONTAL	6675
		SOPORTE PARA MOTOR FRONTAL	6675-H





		APLICACIÓN / DESCRIPTION	DAI PARTS #	DAI KIT PARTS #
BASES PARA AMORTIGUADOR / STRUT MOUNTS				
86-95		BASE PARA AMORTIGUADOR FRONTAL IZQUIERDA Y DERECHA	6730	6730-KIT
86-07		BASE PARA AMORTIGUADOR TRASERA IZQUIERDA Y DERECHA	6733	6733-KIT
96-07		BASE PARA AMORTIGUADOR FRONTAL IZQUIERDA Y DERECHA		7286-KIT



 		APLICACIÓN / DESCRIPTION	DAI PARTS #
CUBRE POLVOS / C.V. BOOTS			
	86-95	CUBRE POLVO DERECHO LADO CAJA	6391
		CUBRE POLVO IZQUIERDO Y DERECHO LADO RUEDA	6378



CONTINUACIÓN... TAURUS

	 28	APLICACIÓN / DESCRIPTION	DAI PARTS #
CUBRE POLVOS / C.V. BOOTS			
	86-95	CUBRE POLVO IZQUIERDO Y DERECHO LADO CAJA	6380



MISCELÁNEOS / AUTOMOTIVE RUBBER PARTS

	86-94	TOPE PARA AMORTIGUADOR FRONTAL TRASERO IZQUIERDO Y DERECHO	D-0621
	86-95	TORNILLO ESTABILIZADOR FRONTAL (MISMO K-8639)	DAI-K-8702
		BUJE PARA HORQUILLA INFERIOR	DAI-K-8452-A
	96-07	TORNILLO ESTABILIZADOR FRONTAL IZQUIERDO	DAI-K-8734



TEMPO

SOPORTES / TRANSMISSION & MOTOR MOUNTS

L4 2.3	83-94	SOPORTE PARA TRANSMISIÓN (1870)	6782
		REPUESTO PARA SOPORTE DE TRANSMISIÓN (1870)	1870-9



CONTINUACIÓN... TEMPO

		 28	APLICACIÓN / DESCRIPTION	DAI PARTS #
SOPORTES / TRANSMISION & MOTOR MOUNTS				
L4 2.3	87-91		SOPORTE PARA MOTOR DERECHO (4 VEL.)	1823
	87-92		SOPORTE PARA MOTOR FRONTAL (4 VEL.)	1872
			SOPORTE PARA MOTOR TRASERO (5 VEL.)	1873
			REPUESTO PARA SOPORTE MOTOR TRASERO (1873)	1873-9
			REPUESTO PARA SOPORTE MOTOR DERECHO (1823)	1874
			SOPORTE PARA TRANSMISIÓN AUT. (5 VEL.)	1884
			SOPORTE PARA TRANSMISIÓN AUT. (5 VEL.)	1884-H
V6 3.0	92-94		COMPLEMENTO PARA HORQUILLA LIMITADORA	1826
			SOPORTE PARA TRANSMISIÓN	1870
			SOPORTE PARA MOTOR FRONTAL	1871
			SOPORTE PARA TRANSMISIÓN AUT. (5 VEL.)	1884
			SOPORTE PARA TRANSMISIÓN AUT. (5 VEL.)	1884-H
			REPUESTO PARA SOPORTE DE TRANSMISIÓN IZQUIERDO	1979
			REPUESTO SOPORTE PARA MOTOR DERECHO	6691



CONTINUACIÓN... TEMPO



  28		APLICACIÓN / DESCRIPTION	DAI PARTS #
SOPORTES / TRANSMISSION & MOTOR MOUNTS			
V6 3.0	92-94	SOPORTE PARA TRANSMISIÓN TRASERO	6712
		REPUESTO PARA SOPORTE DE TRANSMISIÓN (1870)	1870-9
		REPUESTO PARA SOPORTE DE TRANSMISIÓN TRASERO (6712)	6712-9



 28		APLICACIÓN / DESCRIPTION	DAI PARTS #	DAI KIT PARTS #
BASES PARA AMORTIGUADOR / STRUT MOUNTS				
83-94	BASE PARA AMORTIGUADOR FRONTAL IZQUIERDA Y DERECHA		1855	
	BASE PARA AMORTIGUADOR TRASERA IZQUIERDA Y DERECHA		6715	6715-KIT
	BASE PARA AMORTIGUADOR FRONTAL IZQUIERDA Y DERECHA		6784	6784-KIT
	BALERO PARA BASE DE AMORTIGUADOR 1855, 6784 Y 6784-KIT		6138	



CONTINUACIÓN... TEMPO

 		APLICACIÓN / DESCRIPTION	DAI PARTS #
MISCELÁNEOS / AUTOMOTIVE RUBBER PARTS			
83-94		GOMA PARA CREMALLERA DE DIRECCIÓN HID. (IZQUIERDA PAR 714)	710
		GOMA PARA CREMALLERA DE DIRECCIÓN STD. (DERECHA PAR 715 Y 716)	714
		GOMA PARA CREMALLERA DE DIRECCIÓN HID. (IZQUIERDA PAR 714)	715
		GOMA PARA CREMALLERA DE DIRECCIÓN STD. (IZQUIERDA Y DERECHA)	716
		TOPE PARA AMORTIGUADOR FRONTAL IZQUIERDO Y DERECHO	D-0620
		BUJE PARA HORQUILLA (BRAZO) INFERIOR NEGRO	DAI-K-8417
		BUJE PARA HORQUILLA INFERIOR INTERIOR (BRAZO)	DAI-K-8436

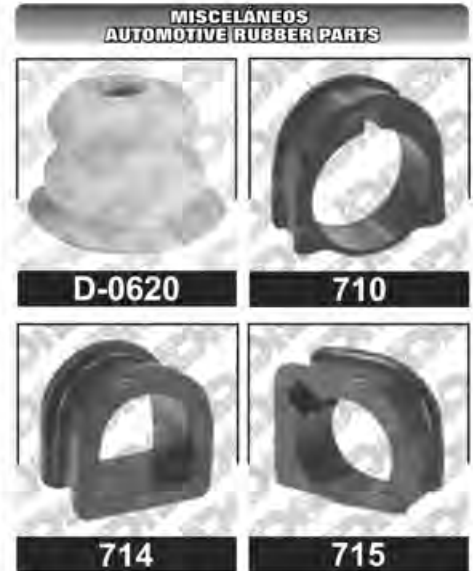

THUNDERBIRD

SOPORTES / TRANSMISSION & MOTOR MOUNTS			
V6 3.8	85-94	SOPORTE PARA MOTOR DERECHO	6623
		SOPORTE PARA MOTOR IZQUIERDO Y DERECHO	1881



CONTINUACIÓN... THUNDERBIRD

 		APLICACIÓN / DESCRIPTION	DAI PARTS #
SOPORTES / TRANSMISSION & MOTOR MOUNTS			
V6 3.8	85-94	SOPORTE PARA MOTOR IZQUIERDO Y DERECHO	1881-H
		SOPORTE PARA TRANSMISIÓN AUT.	6828
		SOPORTE PARA MOTOR DERECHO	6788
		SOPORTE PARA MOTOR IZQUIERDO	6796
V8 3.9	02-05	SOPORTE PARA MOTOR IZQUIERDO Y DERECHO	7566-H
V8 4.2	1991	SOPORTE PARA TRANSMISIÓN	1845
V8 4.2 V8 5.0	1991	SOPORTE PARA MOTOR IZQUIERDO	6786
		SOPORTE PARA MOTOR IZQUIERDO	6796
		SOPORTE PARA MOTOR DERECHO	6797
		SOPORTE PARA MOTOR IZQUIERDO Y DERECHO	1881
		SOPORTE PARA MOTOR IZQUIERDO Y DERECHO	1881-H
		SOPORTE PARA TRANSMISIÓN	6622
V8 5.0	1991	SOPORTE PARA TRANSMISIÓN	1845

SOPORTES TRANSMISSION & MOTOR MOUNTS

1845

1881

1881-H

6622

6786

6788

6796

6797

6828

7566-H

CONTINUACIÓN... THUNDERBIRD

28	APLICACIÓN / DESCRIPTION	DAI PARTS #	DAI KIT PARTS #
BASES PARA AMORTIGUADOR / STRUT MOUNTS			
90-97	BASE PARA AMORTIGUADOR FRONTAL IZQUIERDA Y DERECHA	6740	6740-KIT
87-89	BASE PARA AMORTIGUADOR FRONTAL IZQUIERDA Y DERECHA	6741	6741-KIT
80-86	BASE PARA AMORTIGUADOR FRONTAL IZQUIERDA Y DERECHA	6742	6742-KIT



28	APLICACIÓN / DESCRIPTION	DAI PARTS #
CUBRE POLVOS / C.V. BOOTS		
87-89	CUBRE POLVO IZQUIERDO Y DERECHO DE DIRECCIÓN HID.	6342
	CUBRE POLVO IZQUIERDO Y DERECHO DE DIRECCIÓN HID.	6361
90-97	CUBRE POLVO IZQUIERDO Y DERECHO LADO CAJA	6380
	CUBRE POLVO IZQUIERDO Y DERECHO LADO RUEDA	6378



CONTINUACIÓN... THUNDERBIRD

		28	APLICACIÓN / DESCRIPTION	DAI PARTS #
MISCELÁNEOS / AUTOMOTIVE RUBBER PARTS				
80-86			GOMA SUJETADORA DE ESCAPE	70
			GOMA SUJETADORA DE ESCAPE	72
			TORNILLO ESTABILIZADOR (7", 203.2 mm)	6102
			TORNILLO ESTABILIZADOR (7", 203.2 mm EQUIPO ORIGINAL)	6106
80-97			TOPE PARA AMORTIGUADOR FRONTAL TRASERO IZQUIERDO Y DERECHO	D-0621
87-88			TOPE PARA AMORTIGUADOR FRONTAL IZQUIERDO Y DERECHO	D-0620
87-89			TORNILLO ESTABILIZADOR (10", 254.0mm)	6103
90-97			TORNILLO EXCENTRICO	64600

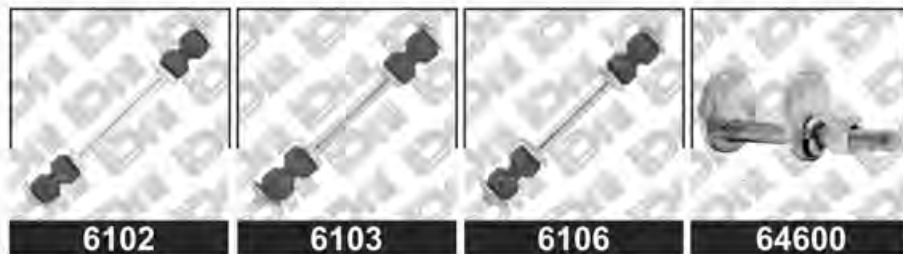
TODOS LOS MODELOS

SOPORTES / TRANSMISSION & MOTOR MOUNTS			
	49-53	SOPORTE PARA MOTOR IZQUIERDO Y DERECHO	1164
V8 3.9 V8 4.2	32-68	SOPORTE PARA MOTOR INFERIOR	1100



CONTINUACIÓN... TODOS LOS MODELOS

 		APLICACIÓN / DESCRIPTION	DAI PARTS #
SOPORTES / TRANSMISSION & MOTOR MOUNTS			
L6 5.8	62-78	SOPORTE PARA MOTOR CENTRAL INFERIOR	1680



TOPAZ

SOPORTES / TRANSMISSION & MOTOR MOUNTS			
L4 2.3	87-92	SOPORTE PARA MOTOR DERECHO (4 VEL.)	1823
		REPUESTO PARA SOPORTE MOTOR DERECHO (1823)	1874
		SOPORTE PARA MOTOR FRONTAL (4 VEL.)	1872
		SOPORTE PARA MOTOR TRASERO (5 VEL.)	1873
		REPUESTO PARA SOPORTE MOTOR TRASERO (1873)	1873-9
		SOPORTE PARA TRANSMISIÓN AUT. (5 VEL.)	1884
		SOPORTE PARA TRANSMISIÓN AUT. (5 VEL.)	1884-H
V6 3.0	92-94	COMPLEMENTO PARA HORQUILLA LIMITADORA	1826
		SOPORTE PARA MOTOR FRONTAL	1871



CONTINUACIÓN... TOPAZ

 		APLICACIÓN / DESCRIPTION	DAI PARTS #
SOPORTES / TRANSMISSION & MOTOR MOUNTS			
V6 3.0	92-94	SOPORTE PARA TRANSMISIÓN	1870
		REPUESTO PARA SOPORTE DE TRANSMISIÓN (1870)	1870-9
		SOPORTE PARA TRANSMISIÓN AUT.	1884
		SOPORTE PARA TRANSMISIÓN AUT.	1884-H
		REPUESTO PARA SOPORTE DE TRANSMISIÓN IZQUIERDO	1979
		REPUESTO SOPORTE PARA MOTOR DERECHO	6691
		SOPORTE PARA TRANSMISIÓN TRASERO	6712
		REPUESTO PARA SOPORTE DE TRANSMISIÓN TRASERO (6712)	6712-9
		REPUESTO PARA SOPORTE (1871 Y 1872)	6919



 		APLICACIÓN / DESCRIPTION	DAI PARTS #	DAI KIT PARTS #
BASES PARA AMORTIGUADOR / STRUT MOUNTS				
83-94	BASE PARA AMORTIGUADOR FRONTAL IZQUIERDA Y DERECHA		1855	6784-KIT
	BASE PARA AMORTIGUADOR TRASERA IZQUIERDA Y DERECHA		6715	6715-KIT



CONTINUACIÓN... TOPAZ

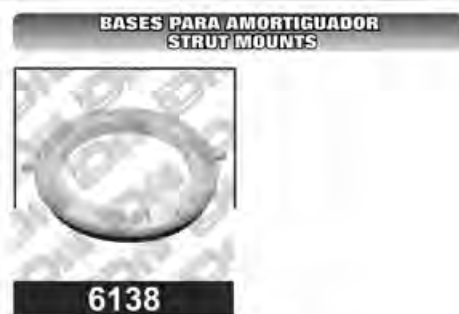

28	APLICACIÓN / DESCRIPTION	DAI PARTS #	DAI KIT PARTS #
BASES PARA AMORTIGUADOR / STRUT MOUNTS			
83-94	BALERO PARA BASES DE AMORTIGUADOR 1855, 6784 Y 6784-KIT	6138	



28	APLICACIÓN / DESCRIPTION	DAI PARTS #
CUBRE POLVOS / C.V. BOOTS		
83-94	CUBRE POLVO IZQUIERDO Y DERECHO LADO RUEDA	6304
	CUBRE POLVO IZQUIERDO Y DERECHO LADO CAJA	6330
	CUBRE POLVO DERECHO DE DIRECCIÓN STD.	6370
	CUBRE POLVO IZQUIERDO DE DIRECCIÓN STD.	6371
	CUBRE POLVO IZQUIERDO Y DERECHO DE DIRECCIÓN HID.	6369
	CUBRE POLVO IZQUIERDO Y DERECHO LADO RUEDA	6392
	CUBRE POLVO DERECHO LADO CAJA (MANUAL)	6375
	CUBRE POLVO DERECHO LADO CAJA	6393



CONTINUACIÓN... TOPAZ

  28		APLICACIÓN / DESCRIPTION	DAI PARTS #
CUBRE POLVOS / C.V. BOOTS			
83-94		CUBRE POLVO IZQUIERDO LADO CAJA	6394
		CUBRE POLVO IZQUIERDO Y DERECHO DE DIRECCIÓN HID.	6399



MISCELÁNEOS / AUTOMOTIVE RUBBER PARTS			
83-94		AUMENTO PARA RESORTE	73
		GOMA PARA RADIADOR INFERIOR	504
		GOMA PARA CREMALLERA DE DIRECCIÓN STD. IZQUIERDA Y DERECHA	700
		GOMA PARA CREMALLERA DE DIRECCIÓN HID. (IZQUIERDA PAR 714)	710
		GOMA PARA CREMALLERA DE DIRECCIÓN STD. (DERECHA PAR 715 Y 716)	714
		GOMA PARA CREMALLERA DE DIRECCIÓN HID. (IZQUIERDA PAR 714)	715
		GOMA PARA CREMALLERA DE DIRECCIÓN STD. (IZQUIERDA Y DERECHA)	716
		GOMA PARA BARRA ESTABILIZADORA	6422
		GOMA PARA TIRANTE DE SUSPENSIÓN	64480
		GOMA PARA ROTULA BRAZO INFERIOR	64770

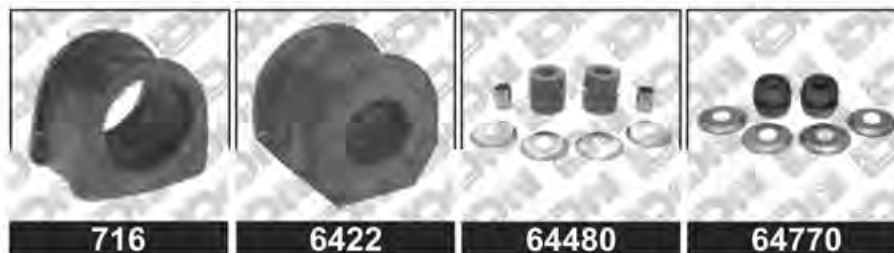
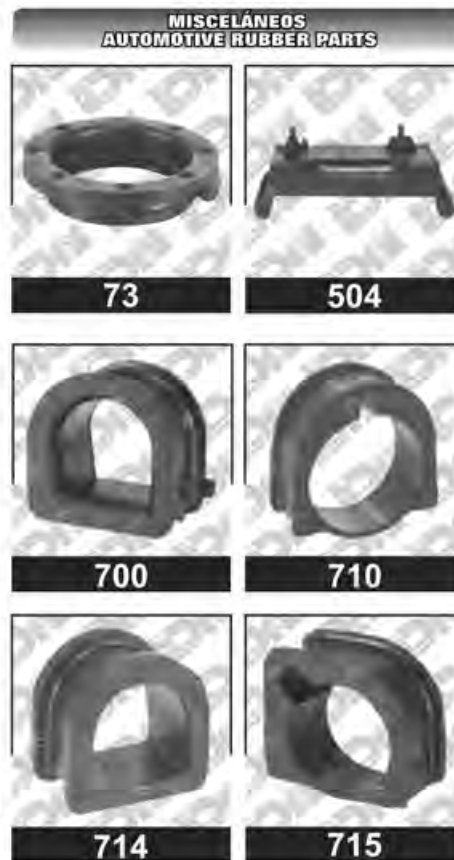

CONTINUACIÓN... TOPAZ

 		APLICACIÓN / DESCRIPTION	DAI PARTS #
MISCELÁNEOS / AUTOMOTIVE RUBBER PARTS			
83-94		TOPE PARA AMORTIGUADOR FRONTAL IZQUIERDO Y DERECHO	D-0619
		TOPE PARA AMORTIGUADOR FRONTAL IZQUIERDO Y DERECHO	D-0620
		BUJE PARA HORQUILLA (BRAZO) INFERIOR NEGRO	DAI-K-8417
		BUJE PARA HORQUILLA INFERIOR INTERIOR (BRAZO)	DAI-K-8436



TRANSIT

SOPORTES / TRANSMISSION & MOTOR MOUNTS			
L4 2.2	07-13	SOPORTE PARA TRANSMISIÓN (DIESEL)	7553
		SOPORTE PARA MOTOR DERECHO (DIESEL)	7560-H



TRANSIT CONNECT

	 28	APLICACIÓN / DESCRIPTION	DAI PARTS #
SOPORTES / TRANSMISSION & MOTOR MOUNTS			
L4 2.0	10-13	SOPORTE PARA TRANSMISIÓN STD.	7000
		SOPORTE PARA MOTOR TRASERO	7064
L4 1.6	14-16	SOPORTE PARA MOTOR TRASERO	7617
		SOPORTE PARA TRANSMISIÓN	7689
		SOPORTE PARA MOTOR TRASERO REFORZADO	7759
L4 2.5	14-17	SOPORTE PARA MOTOR TRASERO	7617
		SOPORTE PARA TRANSMISIÓN	7689
		SOPORTE PARA MOTOR TRASERO REFORZADO	7759

VAM SERIES E

	 28	APLICACIÓN / DESCRIPTION	DAI PARTS #
SOPORTES / TRANSMISSION & MOTOR MOUNTS			
L6 4.9	85-96	SOPORTE PARA MOTOR DERECHO	6764
		SOPORTE PARA MOTOR IZQUIERDO	6769



CONTINUACIÓN... VAM SERIES E

	 28	APLICACIÓN / DESCRIPTION	DAI PARTS #
MISCELÁNEOS / AUTOMOTIVE RUBBER PARTS			
		TAPON PARA BOMBA DE AGUA 3/4"	6011



VARIOS

MISCELÁNEOS / AUTOMOTIVE RUBBER PARTS

	GOMA PARA AMORTIGUADOR CÓNICA	34
	GOMA PARA AMORTIGUADOR CÓNICA	36
	GOMA PARA AMORTIGUADOR CILINDRICA	43
	GOMA PARA AMORTIGUADOR CILINDRICA	67
	GOMA PARA AMORTIGUADOR CILINDRICA	65
	GOMA SUJETADORA DE ESCAPE	68
	GOMA SUJETADORA DE ESCAPE	69
	TOPE PARA SUSPENSIÓN DELANTERA (DIA. 50 mm ALT. 50 mm)	304
	TOPE PARA SUSPENSIÓN DELANTERA INFERIOR (DIA. 45 mm ALT. 75 mm)	306
	TOPE PARA SUSPENSIÓN TRASERA (BASE 40 X 60 mm ALT. 52 mm)	312

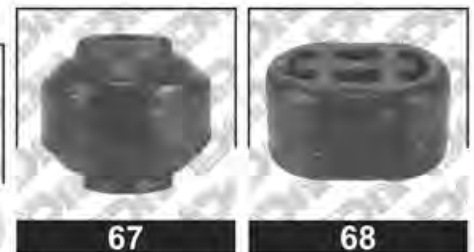

CONTINUACIÓN... VARIOS

		28	APLICACIÓN / DESCRIPTION	DAI PARTS #	MISCELÁNEOS / AUTOMOTIVE RUBBER PARTS	
			TOPE PARA SUSPENSIÓN DELANTERA (LARGO 40 mm ALT. 50 mm)	315		
			TOPE PARA SUSPENSIÓN TRASERA (BASE 100 X 55 mm ALT. 55 mm)	318		
			TOPE PARA SUSPENSIÓN TRASERA (BASE 50 X 55 mm ALT. 52 mm)	395		
			GOMA PARA RADIADOR	502		
61-69			GOMA PARA BARRA ESTABILIZADORA	6063		
65-08			GALLETA PARA DIRECCIÓN STD. (2 PERNOS DELGADOS COMPLETO 602, 610, 608 Y 614)	622		
65-66			COPELE PARA DIRECCIÓN STD. (SINFIN REDONDO DE .725" 2 PERNOS DELGADOS)	602		
66-92			GALLETA PARA DIRECCIÓN STD. Y HID. (2 PERNOS MIXTOS COMPLETO 603)	621		
67-73			COPELE PARA DIRECCIÓN STD. (SINFIN REDONDO DE .725" 1 PERNO GRUESO Y 1 PERNO DELGADO)	603		
74-08			COPELE PARA DIRECCIÓN (SINFIN REDONDO DE .725" 2 PERNOS GRUESOS)	601		
			GALLETA PARA DIRECCIÓN STD. Y HID. (2 PERNOS GRUESOS COMPLETO 601)	620		
85-07			COPELE PARA DIRECCIÓN HID. (SINFIN DE .700" 2 PERNOS DELGADOS)	615		

620	621	622	6063



CONTINUACIÓN... VARIOS

	 28	APLICACIÓN / DESCRIPTION	DAI PARTS #
MISCELÁNEOS / AUTOMOTIVE RUBBER PARTS			
	85-95	COPLE PARA DIRECCIÓN CHICO 2 5/8" (SINFÍN DE .725")	607
		GALLETAS PARA DIRECCIÓN (4 PERNOS COPLE CHICO 2 5/8" COMPLETO 607 Y 617 NACIONALES Y AMERICANOS)	625
	97-02	GOMA PARA BARRA ESTABILIZADORA	93

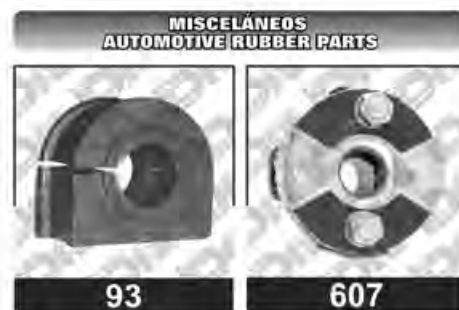

WINDSTAR

SOPORTES / TRANSMISSION & MOTOR MOUNTS			
V6 3.0	99-00	SOPORTE PARA MOTOR DERECHO	7192
V6 3.8	1995	SOPORTE PARA MOTOR TRASERO	6674
		SOPORTE PARA MOTOR TRASERO	6674-H
	95-04	SOPORTE PARA TRANSMISIÓN AUT.	7199-H
	96-98	SOPORTE PARA MOTOR DERECHO	7191
	97-98	SOPORTE PARA TRANSMISIÓN	7096
	99-04	SOPORTE PARA MOTOR DERECHO	7192
SOPORTE PARA MOTOR FRONTAL		6675	



CONTINUACIÓN WINDSTAR

28		APLICACIÓN / DESCRIPTION	DAI PARTS #
SOPORTES / TRANSMISSION & MOTOR MOUNTS			
V6 3.8	99-04	SOPORTE PARA MOTOR FRONTAL	6675-H
		SOPORTE PARA MOTOR FRONTAL	6839-H



28		APLICACIÓN / DESCRIPTION	DAI PARTS #	DAI KIT PARTS #
BASES PARA AMORTIGUADOR / STRUT MOUNTS				
95-04		BASE PARA AMORTIGUADOR FRONTAL IZQUIERDA Y DERECHA		7229-KIT



28		APLICACIÓN / DESCRIPTION	DAI PARTS #
CUBRE POLVOS / C.V. BOOTS			
	95-04	CUBRE POLVO IZQUIERDO Y DERECHO DE DIRECCIÓN HID.	6399
		MACHETA Ó CUBRE POLVO IZQUIERDO Y DERECHO LADO RUEDA	6337
		CUBRE POLVO IZQUIERDO Y DERECHO DE DIRECCIÓN HID.	63112



CONTINUACIÓN... WINDSTAR

	 28	APLICACIÓN / DESCRIPTION	DAI PARTS #
MISCELÁNEOS / AUTOMOTIVE RUBBER PARTS			
	95-98	BUJE PARA HORQUILLA INFERIOR	DAI-K-8452-A
	94-03	TOPE PARA AMORTIGUADOR FRONTAL Y TRASERO IZQUIERDO Y DERECHO	D-0621
	95-04	GOMA PARA BARRA ESTABILIZADORA	64696
		TORNILLO ESTABILIZADOR FRONTAL	DAI-K-8702



DAI-K-8452-A



DAI-K-8702





A large, rectangular area with a torn-paper edge, containing approximately 20 horizontal lines for writing or drawing.



HONDA

ACCORD

	28	APLICACIÓN / DESCRIPTION	DAI PARTS #
--	----	---------------------------------	--------------------



SOPORTES / TRANSMISSION & MOTOR MOUNTS

L4 2.2	90-93	SOPORTE PARA MOTOR IZQUIERDO	7682
		SOPORTE PARA MOTOR TRASERO	6815
	90-97	SOPORTE PARA MOTOR TRASERO	6815-H
		SOPORTE PARA MOTOR TRASERO STD.	7684
	94-95	SOPORTE PARA TRANSMISIÓN	6809
		SOPORTE PARA MOTOR FRONTAL	6775
	94-97	SOPORTE PARA MOTOR IZQUIERDO	6816
SOPORTE PARA MOTOR FRONTAL STD.		7747	
L4 2.3	98-02	SOPORTE PARA MOTOR FRONTAL	7502
		SOPORTE PARA TRANSMISIÓN DERECHO	7647
		SOPORTE PARA MOTOR TRASERO	7718-H
L4 2.4	03-07	SOPORTE PARA TRANSMISIÓN AUT. (FRONTAL INFERIOR)	7193
		SOPORTE PARA TRANSMISIÓN AUT. (TRASERO INFERIOR)	7202
		SOPORTE PARA MOTOR TRASERO	7207-H

SOPORTES TRANSMISSION & MOTOR MOUNTS



CONTINUACIÓN... ACCORD

 		APLICACIÓN / DESCRIPTION	DAI PARTS #
SOPORTES / TRANSMISSION & MOTOR MOUNTS			
L4 2.4	03-07	SOPORTE PARA TRANSMISIÓN	7248
		SOPORTE PARA TRANSMISIÓN FRONTAL INFERIOR	7677
	03-08	SOPORTE PARA MOTOR DERECHO	7205-H
	03-09	SOPORTE PARA MOTOR FRONTAL	7206-H
	08-12	SOPORTE PARA MOTOR TRASERO	7349
		SOPORTE PARA TRANSMISIÓN FRONTAL INFERIOR	7396
		SOPORTE PARA TRANSMISIÓN STD. SUPERIOR	7398-H
		SOPORTE PARA MOTOR FRONTAL	7397-H
		SOPORTE PARA MOTOR DERECHO	7501-H
	13-16	SOPORTE PARA TRANSMISION SUPERIOR STD. Y AUT. (SIN ALUMINIO)	7398-H-9
13-17	SOPORTE PARA MOTOR DERECHO	7789-H	
	SOPORTE PARA MOTOR FRONTAL	7679-H	
	SOPORTE PARA MOTOR TRASERO STD.	7680	
	SOPORTE PARA TRANSMISIÓN INFERIOR	7681	
V6 3.0	98-02	SOPORTE PARA MOTOR DERECHO	7050

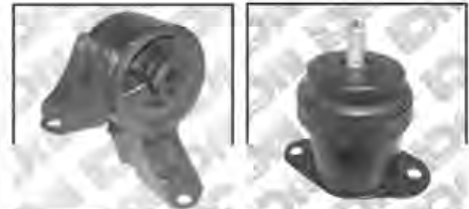
SOPORTES TRANSMISSION & MOTOR MOUNTS

7050
7205-H

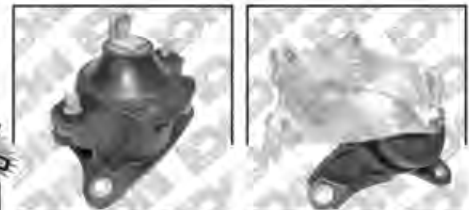

7206-H
7248

7349
7396

7397-H
7398-H

7398-H-9
7501-H
7677
7679-H

7680
7681
7789-H

CONTINUACIÓN... ACCORD

 		APLICACIÓN / DESCRIPTION	DAI PARTS #
SOPORTES / TRANSMISSION & MOTOR MOUNTS			
V6 3.0	98-02	SOPORTE PARA TRANSMISIÓN FRONTAL	7052
		SOPORTE PARA TRANSMISIÓN TRASERO	7053
		SOPORTE PARA TRANSMISIÓN TRASERO	7165
		SOPORTE PARA MOTOR TRASERO	7503-H
		SOPORTE PARA MOTOR FRONTAL	7709-H
	03-07	SOPORTE PARA MOTOR TRASERO	7207-H
		SOPORTE PARA TRANSMISIÓN	7508
		SOPORTE PARA TRANSMISIÓN FRONTAL	7590
		SOPORTE PARA MOTOR TRASERO AUT.	7704-H
	03-08	SOPORTE PARA TRANSMISION STD. FRONTAL INFERIOR	7796
03-08	SOPORTE PARA MOTOR DERECHO	7205-H	
03-09	SOPORTE PARA MOTOR FRONTAL	7206-H	
V6 3.5	08-12	SOPORTE PARA TRANSMISIÓN STD. SUPERIOR	7398-H
		SOPORTE PARA MOTOR TRASERO	7518-EL
		SOPORTE PARA MOTOR FRONTAL	7519-EL
		SOPORTE PARA TRANSMISIÓN FRONTAL INFERIOR	7557

SOPORTES TRANSMISSION & MOTOR MOUNTS



7052 **7053**



7165 **7205-H**



7206-H **7207-H**



7398-H **7503-H**



7508 **7518-EL** **7519-EL** **7557**



7590 **7704-H** **7709-H** **7796**



CONTINUACIÓN... ACCORD

28	APLICACIÓN / DESCRIPTION	DAI PARTS #	DAI KIT PARTS #
BASES PARA AMORTIGUADOR / STRUT MOUNTS			
86-12	BASE PARA AMORTIGUADOR FRONTAL IZQUIERDA Y DERECHA	6736	6736-KIT
	BASE PARA AMORTIGUADOR FRONTAL IZQUIERDA Y DERECHA	6755	

6755

28	APLICACIÓN / DESCRIPTION	DAI PARTS #
CUBRE POLVOS / C.V. BOOTS		
98-02	CUBRE POLVO IZQUIERDO Y DERECHO LADO CAJA (CON TRIPOIDE)	6308



MISCELÁNEOS / AUTOMOTIVE RUBBER PARTS		
98-02	BUJES PARA BARRA TENSORA TRASERA	DAI-K-90204-B
	TORNILLO ESTABILIZADOR DERECHO	DAI-2109002
	TORNILLO ESTABILIZADOR IZQUIERDO	DAI-2109003
03-07	TORNILLO ESTABILIZADOR FRONTAL IZQUIERDO	DAI-2109013
	BUJE PARA HORQUILLA INFERIOR GRANDE	DAI-1409012

DAI-2109003 DAI-2109013 DAI-K-90204-B

CITY

  28		APLICACIÓN / DESCRIPTION	DAI PARTS #
SOPORTES / TRANSMISSION & MOTOR MOUNTS			
L4 1.5	09-13	SOPORTE PARA MOTOR TRASERO TRANSMISIÓN STD.	7568
		SOPORTE PARA MOTOR TRASERO TRANSMISIÓN AUT.	7569
		SOPORTE PARA TRANSMISIÓN STD.	7707
		SOPORTE PARA MOTOR DERECHO	7710
		SOPORTE PARA TRANSMISIÓN AUT.	7756
14-17		SOPORTE PARA TRANSMISION AUT.	7764
		SOPORTE PARA MOTOR TRASERO TORQUE STRUT	7767
		SOPORTE PARA TRANSMISIÓN STD.	7778

SOPORTES TRANSMISSION & MOTOR MOUNTS



7568



7569



7707



7710



7756



7764



7767



7778

 28		APLICACIÓN / DESCRIPTION	DAI PARTS #	DAI KIT PARTS #
BASES PARA AMORTIGUADOR / STRUT MOUNTS				
06-08		BASE PARA AMORTIGUADOR FRONTAL IZQUIERDA Y DERECHA		7591-KIT

BASES PARA AMORTIGUADOR STRUT MOUNTS



7591-KIT



CONTINUACIÓN... CITY



	28	APLICACIÓN / DESCRIPTION	DAI PARTS #
CUBRE POLVOS / C.V. BOOTS			
09-14		TOPE PARA AMORTIGUADOR FRONTAL IZQUIERDO Y DERECHO	2018

CIVIC
SOPORTES / TRANSMISSION & MOTOR MOUNTS

L4 1.3	80-83	SOPORTE PARA MOTOR FRONTAL	6776
	03-05	SOPORTE PARA MOTOR TRASERO (HIBRIDO)	7047
	06-11	SOPORTE PARA MOTOR DERECHO (HIBRIDO)	7763
L4 1.5	92-95	SOPORTE PARA MOTOR TRASERO	6810
		SOPORTE PARA MOTOR FRONTAL	6818
		SOPORTE MOTOR FRONTAL IZQUIERDO STD.	6819
	93-95	SOPORTE PARA MOTOR TRASERO DEL SOL	6810
		SOPORTE PARA MOTOR FRONTAL DEL SOL	6818
		SOPORTE PARA MOTOR FRONTAL STD. IZQUIERDO DEL SOL	6819
L4 1.6	92-00	SOPORTE PARA MOTOR TRASERO	6810
		SOPORTE PARA MOTOR FRONTAL (EXCEPTO CIVIC DEL SOL 99-00)	6818
		SOPORTE PARA MOTOR FRONTAL IZQUIERDO (EXCEPTO DEL SOL 99-00)	6819
	93-97	SOPORTE PARA MOTOR FRONTAL DEL SOL	6810
		SOPORTE PARA MOTOR FRONTAL DEL SOL	6818
		SOPORTE PARA MOTOR FRONTAL IZQUIERDO STD. DEL SOL	6819

SOPORTES TRANSMISSION & MOTOR MOUNTS

CONTINUACIÓN... CIVIC

 		APLICACIÓN / DESCRIPTION	DAI PARTS #
SOPORTES / TRANSMISSION & MOTOR MOUNTS			
L4 1.6	96-00	SOPORTE PARA MOTOR IZQUIERDO	6817
		SOPORTE PARA TRANSMISIÓN	6808
L4 1.7	01-04	SOPORTE PARA MOTOR FRONTAL AUT.	7043
		SOPORTE PARA TRANSMISIÓN STD. Y AUT.	7044
	01-05	SOPORTE PARA MOTOR FRONTAL STD.	7046
		SOPORTE PARA MOTOR TRASERO	7047
	02-05	SOPORTE PARA MOTOR IZQUIERDO	7048-H
		SOPORTE PARA TRANSMISIÓN	7100
	03-05	REPUESTO PARA SOPORTE DE TRANSMISIÓN (7100)	7100-9
		SOPORTE PARA MOTOR FRONTAL	7101
SOPORTE PARA MOTOR TRASERO		7102	
L4 1.8	06-11	SOPORTE PARA MOTOR FRONTAL DERECHO SUPERIOR STD.	7412
		SOPORTE PARA MOTOR TRASERO STD.	7413
		SOPORTE PARA MOTOR TRASERO AUT.	7223
		SOPORTE PARA TRANSMISIÓN	7224

SOPORTES TRANSMISSION & MOTOR MOUNTS

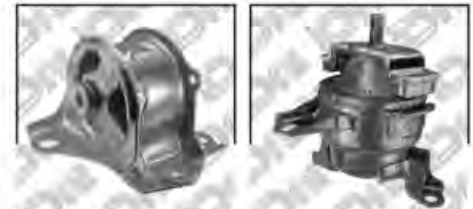

6808



6817



7043



7044



7046



7047



CONTINUACIÓN... CIVIC

 28		APLICACIÓN / DESCRIPTION	DAI PARTS #
SOPORTES / TRANSMISSION & MOTOR MOUNTS			
L4 1.8	06-11	SOPORTE PARA MOTOR FRONTAL DERECHO SUPERIOR AUT.	7268
		SOPORTE PARA MOTOR DERECHO INFERIOR (COUPE 2 PUERTAS)	7323-H
L4 2.0	02-05	SOPORTE PARA MOTOR FRONTAL	7523
	06-11	SOPORTE PARA MOTOR TRASERO TORQUE STRUT SI	7792
		SOPORTE PARA TRANSMISIÓN SI	7712
	07-11	SOPORTE PARA MOTOR FRONTAL SI	7673
L4 2.0 L4 2.4	06-15	SOPORTE PARA MOTOR DERECHO SUPERIOR TORQUE STRUT SI	7746

SOPORTES TRANSMISSION & MOTOR MOUNTS

7268

7323-H

7523

7673

7712

7746

7792

28		APLICACIÓN / DESCRIPTION	DAI PARTS #	DAI KIT PARTS #
BASES PARA AMORTIGUADOR / STRUT MOUNTS				
88-00		BASE PARA AMORTIGUADOR FRONTAL IZQUIERDA Y DERECHA	6736	6736-KIT

BASES PARA AMORTIGUADOR STRUT MOUNTS

6736

6736-KIT

CONTINUACIÓN... CIVIC

28	APLICACIÓN / DESCRIPTION	DAI PARTS #	DAI KIT PARTS #
BASES PARA AMORTIGUADOR / STRUT MOUNTS			
88-00	BASE PARA AMORTIGUADOR FRONTAL IZQUIERDA Y DERECHA	6755	
01-05	BASE PARA AMORTIGUADOR FRONTAL DERECHA		7350-KIT
	BASE PARA AMORTIGUADOR FRONTAL IZQUIERDA		7351-KIT
06-11	BASE PARA AMORTIGUADOR FRONTAL IZQUIERDA Y DERECHA		7573-KIT
2001	BASE PARA AMORTIGUADOR FRONTAL IZQUIERDA Y DERECHA (BALERO DELGADO)		7574-KIT

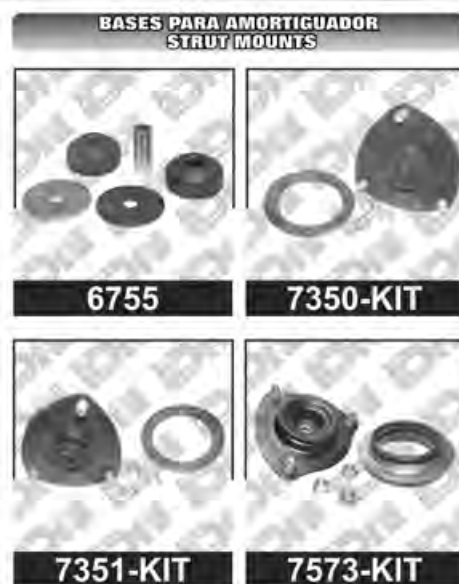

28	APLICACIÓN / DESCRIPTION	DAI PARTS #
CUBRE POLVOS / C.V. BOOTS		
97-00	CUBRE POLVO IZQUIERDO Y DERECHO LADO CAJA (CON TRIPOIDE)	6308
01-05	CUBRE POLVO IZQUIERDO Y DERECHO LADO CAJA (CON TRIPOIDE)	63119
96-00	CUBRE POLVO IZQUIERDO Y DERECHO LADO RUEDA	6378
	CUBRE POLVO IZQUIERDO Y DERECHO LADO CAJA	6396



CONTINUACIÓN... CIVIC

 28	APLICACIÓN / DESCRIPTION	DAI PARTS #
MISCELÁNEOS / AUTOMOTIVE RUBBER PARTS		
88-00	BUJE PARA BRAZO INFERIOR TRASERO	7045
	BRAZO COMPENZADOR TRASERO	DAI-1509015
92-00	BUJE PARA HORQUILLA INFERIOR CHICO (POLIURETANO D.I. 12.50 mm D.E. 37.15 mm A. 51.40 mm)	9234
	BUJE PARA HORQUILLA INFERIOR GRANDE	DAI-51370S04-G00
95-01	GOMAS PARA BARRA ESTABILIZADORA (2)	64732
	BUJE PARA HORQUILLA INFERIOR CHICO (POLIURETANO D.I. 14.50 mm D.E. 37.15 mm A. 51.64 mm)	9232
96-00	BUJE PARA HORQUILLA INFERIOR CHICO (POLIURETANO D.I. 12.50 mm D.E. 37.25 mm A. 51.23 mm)	9233
	TORNILLO ESTABILIZADOR FRONTAL	DAI-2109001
96-03	TOPE PARA AMORTIGUADOR FRONTAL IZQUIERDO Y DERECHO	2007
01-05	TORNILLO ESTABILIZADOR DERECHO	DAI-2109006
	TORNILLO ESTABILIZADOR IZQUIERDO	DAI-2109007
06-11	TORNILLO ESTABILIZADOR FRONTAL IZQUIERDO	DAI-2109021
	TORNILLO ESTABILIZADOR FRONTAL DERECHO	DAI-2109022

**MISCELÁNEOS
AUTOMOTIVE RUBBER PARTS**

2007

7045

9232

9233

9234

64732

DAI-1509015

DAI-2109001

DAI-2109006

DAI-2109007

DAI-2109021

DAI-2109022

DAI-51370S04-G00

CONTINUACIÓN... CIVIC

 		APLICACIÓN / DESCRIPTION	DAI PARTS #
MISCELÁNEOS / AUTOMOTIVE RUBBER PARTS			
06-11		BUJES PARA HORQUILLA TRASERA SUPERIOR	DAI-1509045
		BUJE PARA HORQUILLA CHICO	DAI-1409020
		BUJE PARA HORQUILLA INFERIOR GRANDE	DAI-1409018
		GOMAS PARA BARRA ESTABILIZADORA (2)	DAI-1409026
06-15		TORNILLO ESTABILIZADOR TRASERO DERECHO	DAI-2109028
		TORNILLO ESTABILIZADOR TRASERO IZQUIERDO	DAI-2109029



CL

SOPORTES / TRANSMISSION & MOTOR MOUNTS			
L4 2.2 L4 2.3	97-99	SOPORTE PARA MOTOR FRONTAL AUT.	6775
		SOPORTE PARA TRANSMISIÓN	6809
		SOPORTE PARA MOTOR TRASERO	6815
		SOPORTE PARA MOTOR TRASERO	6815-H
		SOPORTE PARA MOTOR TRASERO STD.	7684
		SOPORTE PARA MOTOR FRONTAL STD.	7747



CONTINUACIÓN... CL

 		APLICACIÓN / DESCRIPTION	DAI PARTS #
SOPORTES / TRANSMISSION & MOTOR MOUNTS			
L4 2.2	97-99	SOPORTE PARA MOTOR IZQUIERDO	6816
V6 3.2	01-03	SOPORTE PARA MOTOR DERECHO	7050
		SOPORTE PARA TRANSMISIÓN FRONTAL	7052
		SOPORTE PARA TRANSMISIÓN (TRASERO)	7165
		SOPORTE PARA MOTOR TRASERO	7503-H
	01-06	SOPORTE PARA MOTOR FRONTAL	7709-H
		SOPORTE PARA TRANSMISIÓN (TRASERO)	7053

SOPORTES TRANSMISSION & MOTOR MOUNTS

6816

7050

7052

7053

7165

7503-H

7709-H
MISCELÁNEOS / AUTOMOTIVE RUBBER PARTS

01-03	BUJES PARA BARRA TENSORA TRASERA	DAI-K-90204-B
	TORNILLO ESTABILIZADOR FRONTAL	DAI-2109001
	TORNILLO ESTABILIZADOR DERECHO	DAI-2109002
	TORNILLO ESTABILIZADOR IZQUIERDO	DAI-2109003

MISCELÁNEOS AUTOMOTIVE RUBBER PARTS

DAI-2109001

DAI-2109002

DAI-2109003

DAI-K-90204-B

CROSSTOUR

		28	APLICACIÓN / DESCRIPTION	DAI PARTS #
SOPORTES / TRANSMISSION & MOTOR MOUNTS				
L4 2.4	12-13		SOPORTE PARA MOTOR DERECHO	7501-H
	12-15		SOPORTE PARA TRANSMISIÓN	7398-H-9
V6 3.5	10-12		SOPORTE PARA MOTOR DERECHO	7501-H
			SOPORTE PARA MOTOR TRASERO	7518-EL
			SOPORTE PARA MOTOR FRONTAL	7519-EL
			SOPORTE PARA TRANSMISIÓN FRONTAL INFERIOR	7557
	12-13		SOPORTE PARA TRANSMISIÓN AUT. SUPERIOR	7398-H



		28	APLICACIÓN / DESCRIPTION	DAI PARTS #	DAI KIT PARTS #
BASES PARA AMORTIGUADOR / STRUT MOUNTS					
10-12			BASE PARA AMORTIGUADOR FRONTAL IZQUIERDA Y DERECHA	6736	6736-KIT
			BASE PARA AMORTIGUADOR FRONTAL IZQUIERDA Y DERECHA	6755	



CR-V

 		APLICACIÓN / DESCRIPTION	DAI PARTS #
SOPORTES / TRANSMISSION & MOTOR MOUNTS			
L4 2.0	97-01	SOPORTE PARA TRANSMISIÓN	6808
		SOPORTE PARA MOTOR TRASERO	6810
		SOPORTE PARA MOTOR IZQUIERDO	6817

SOPORTES TRANSMISSION & MOTOR MOUNTS



6808

6810

L4 2.4	02-06	SOPORTE PARA TRANSMISIÓN	7100
		REPUESTO PARA SOPORTE DE TRANSMISIÓN (7100)	7100-9
		SOPORTE PARA MOTOR FRONTAL	7101
		SOPORTE PARA MOTOR TRASERO	7102
		SOPORTE PARA MOTOR FRONTAL	7523
		SOPORTE PARA MOTOR DERECHO	7633-H
	02-11	SOPORTE PARA DIFERENCIAL (AUT. Y 4X4)	7480
	07-11	SOPORTE PARA MOTOR DERECHO	7653-H
		SOPORTE PARA MOTOR DERECHO SUPERIOR (TORSIÓN)	7632
		SOPORTE PARA MOTOR TRASERO TRANSMISIÓN INFERIOR	7570
12-14	SOPORTE PARA MOTOR DERECHO	7663-H	

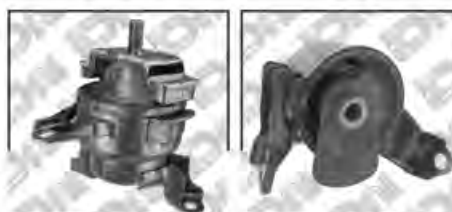

6817

7100



7101

7100-9

NUEVO



7523

7570

7632

7663-H

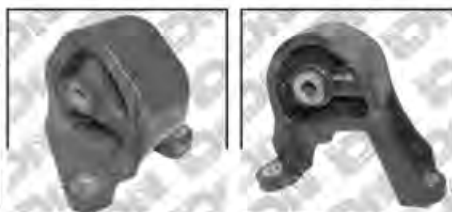

7102

7480



7653-H

7633-H

NUEVO



CONTINUACIÓN... CR-V

 		APLICACIÓN / DESCRIPTION	DAI PARTS #
SOPORTES / TRANSMISSION & MOTOR MOUNTS			
L4 2.4	12-14	SOPORTE PARA MOTOR FRONTAL	7675
	12-16	SOPORTE PARA MOTOR DERECHO SUPERIOR	7648
		SOPORTE PARA MOTOR TRASERO	7649
		SOPORTE PARA TRANSMISIÓN	7650



	APLICACIÓN / DESCRIPTION	DAI PARTS #	DAI KIT PARTS #
BASES PARA AMORTIGUADOR / STRUT MOUNTS			
97-02	BASE PARA AMORTIGUADOR FRONTAL IZQUIERDA Y DERECHA	6736	6736-KIT
	BASE PARA AMORTIGUADOR FRONTAL IZQUIERDA Y DERECHA	6755	
2001	BASE PARA AMORTIGUADOR FRONTAL IZQUIERDA Y DERECHA (BALERO DELGADO)		7574-KIT
02-06	BASE PARA AMORTIGUADOR FRONTAL DERECHA		7350-KIT
	BASE PARA AMORTIGUADOR FRONTAL IZQUIERDA		7351-KIT
07-11	BASE PARA AMORTIGUADOR FRONTAL IZQUIERDA Y DERECHA		7572-KIT



CONTINUACIÓN... CR-V

	28	APLICACIÓN / DESCRIPTION	DAI PARTS #
CUBRE POLVOS / C.V. BOOTS			
02-06		CUBRE POLVO IZQUIERDO Y DERECHO LADO CAJA	63132
		CUBRE POLVO IZQUIERDO Y DERECHO LADO RUEDA	63133

MISCELÁNEOS / AUTOMOTIVE RUBBER PARTS

01-05	TORNILLO ESTABILIZADOR DERECHO	DAI-2109006
	TORNILLO ESTABILIZADOR IZQUIERDO	DAI-2109007
02-06	TORNILLO ESTABILIZADOR TRASERO DERECHO	DAI-2109010
	TORNILLO ESTABILIZADOR TRASERO IZQUIERDO	DAI-2109011
97-01	BUJE PARA HORQUILLA INFERIOR CHICO (POLIURETANO D.I. 14.50 mm D.E. 37.15 mm A. 51.64 mm)	9232
97-01	BUJE PARA HORQUILLA INFERIOR CHICO (POLIURETANO D.I. 12.50 mm D.E. 37.25 mm A. 51.23 mm)	9233
	BRAZO COMPENZADOR TRASERO	DAI-1509015
96-00	BUJE PARA HORQUILLA INFERIOR GRANDE	DAI-51370-S04-G00
02-06	BUJE PARA HORQUILLA INFERIOR GRANDE	DAI-1409018



CONTINUACIÓN... CR-V

  28		APLICACIÓN / DESCRIPTION	DAI PARTS #
MISCELÁNEOS / AUTOMOTIVE RUBBER PARTS			
	07-12	TORNILLO ESTABILIZADOR FRONTAL IZQUIERDO Y DRECHO	DAI-2109023
	07-14	GOMAS PARA BARRA ESTABILIZADORA FRONTAL IZQUIERDA Y DERECHA	DAI-5039013
	07-16	TORNILLO ESTABILIZADOR TRASERO DERECHO	DAI-2109024
		TORNILLO ESTABILIZADOR TRASERO IZQUIERDO	DAI-2109025



CR-X

  28		APLICACIÓN / DESCRIPTION	DAI PARTS #	DAI KIT PARTS #
BASES PARA AMORTIGUADOR / STRUT MOUNTS				
2001		BASE PARA AMORTIGUADOR FRONTAL IZQUIERDA Y DERECHA (BALERO DELGADO)		7574-KIT
02-06		BASE PARA AMORTIGUADOR FRONTAL DERECHA		7350-KIT
06-09		BASE PARA AMORTIGUADOR FRONTAL IZQUIERDA Y DERECHA		7573-KIT



CONTINUACIÓN... CR-X

 28		APLICACIÓN / DESCRIPTION	DAI PARTS #	MISCELÁNEOS / AUTOMOTIVE RUBBER PARTS	
96-00		TORNILLO ESTABILIZADOR FRONTAL	DAI-2109001		 NUEVO
		BUJE PARA HORQUILLA INFERIOR GRANDE	DAI-51370-S04-G00		
06-09		TORNILLO ESTABILIZADOR FRONTAL IZQUIERDO	DAI-2109021		
		TORNILLO ESTABILIZADOR FRONTAL DERECHO	DAI-2109022		
		TORNILLO ESTABILIZADOR TRASERO DERECHO	DAI-2109028		
	TORNILLO ESTABILIZADOR TRASERO IZQUIERDO	DAI-2109029			
06-10		BUJE PARA HORQUILLA INFERIOR GRANDE	DAI-1409018	DAI-2109001	DAI-2109021
06-11		BUJE PARA HORQUILLA INFERIOR CHICO	DAI-1409020		

DAI-2109022

DAI-2109028

DAI-2109029

DAI-51370-S04-G00
CR-Z
SOPORTES / TRANSMISSION & MOTOR MOUNTS

L4 1.5	11-15	SOPORTE PARA MOTOR TRASERO TRANSMISIÓN STD. Y CVT (HIBRIDO)	7568
--------	-------	---	------

SOPORTES TRANSMISSION & MOTOR MOUNTS

7568

CONTINUACIÓN... CR-Z

 APLICACIÓN / DESCRIPTION	DAI PARTS #	DAI KIT PARTS #
BASES PARA AMORTIGUADOR / STRUT MOUNTS		
01-16	BASE PARA AMORTIGUADOR FRONTAL IZQUIERDA Y DERECHA	7591-KIT



ELEMENT

 APLICACIÓN / DESCRIPTION	DAI PARTS #		
SOPORTES / TRANSMISSION & MOTOR MOUNTS			
L4 2.4	03-07	SOPORTE PARA MOTOR TRASERO	7102
	03-08	SOPORTE PARA TRANSMISIÓN	7100
		SOPORTE PARA MOTOR FRONTAL	7101
		REPUESTO PARA SOPORTE DE TRANSMISIÓN (7100)	7100-9
	03-11	SOPORTE PARA MOTOR DERECHO	7633-H
	03-11	SOPORTE PARA MOTOR FRONTAL	7523



 APLICACIÓN / DESCRIPTION	DAI PARTS #	DAI KIT PARTS #
BASES PARA AMORTIGUADOR / STRUT MOUNTS		
03-07	BASE PARA AMORTIGUADOR TRASERA IZQUIERDA Y DERECHA	6755



CONTINUACIÓN... ELEMENT

28	APLICACIÓN / DESCRIPTION	DAI PARTS #	DAI KIT PARTS #
BASES PARA AMORTIGUADOR / STRUT MOUNTS			
03-07	BASE PARA AMORTIGUADOR FRONTAL DERECHA		7350-KIT
	BASE PARA AMORTIGUADOR FRONTAL IZQUIERDA		7351-KIT
03-11	BASE PARA AMORTIGUADOR FRONTAL IZQUIERDA Y DERECHA (BALERO DELGADO)		7574-KIT



28	APLICACIÓN / DESCRIPTION	DAI PARTS #
MISCELÁNEOS / AUTOMOTIVE RUBBER PARTS		
03-08	TORNILLO ESTABILIZADOR DERECHO	DAI-2109006
	TORNILLO ESTABILIZADOR IZQUIERDO	DAI-2109007
03-11	BUJE PARA HORQUILLA INFERIOR GRANDE	DAI-1409018



FIT

	28	APLICACIÓN / DESCRIPTION	DAI PARTS #
--	-----------	---------------------------------	--------------------

SOPORTES / TRANSMISSION & MOTOR MOUNTS

		SOPORTES TRANSMISSION & MOTOR MOUNTS	
L4 1.5	06-08	SOPORTE PARA TRANSMISIÓN AUT.	7425
		SOPORTE PARA MOTOR FRONTAL	7136
		SOPORTE PARA TRANSMISIÓN STD.	7137
		SOPORTE PARA MOTOR TRASERO	7138
		SOPORTE PARA MOTOR DERECHO	7140-H
		REPUESTO PARA SOPORTE DE TRANSMISIÓN (7137 Y 7425)	7425-9
	09-12	SOPORTE PARA TRANSMISIÓN STD.	7707
		SOPORTE PARA TRANSMISIÓN AUT.	7756
		SOPORTE PARA MOTOR TRASERO TRANSMISIÓN STD.	7568
	09-13	SOPORTE PARA MOTOR TRASERO TRANSMISIÓN AUT.	7569
		SOPORTE PARA MOTOR DERECHO	7710
	15-17	SOPORTE PARA TRANSMISION AUT.	7764
SOPORTE PARA MOTOR TRASERO TORQUE STRUT		7767	
SOPORTE PARA TRANSMISION STD.		7778	



7136

7137



7138

7140-H



7425

7425-9



7707

7710

7756

7764



7568

7569



7767

7778



CONTINUACIÓN... FIT

28	APLICACIÓN / DESCRIPTION	DAI PARTS #	DAI KIT PARTS #
BASES PARA AMORTIGUADOR / STRUT MOUNTS			
06-16	BASE PARA AMORTIGUADOR FRONTAL IZQUIERDA Y DERECHA		7591-KIT



28	APLICACIÓN / DESCRIPTION	DAI PARTS #
MISCELÁNEOS / AUTOMOTIVE RUBBER PARTS		
06-08	BUJE INFERIOR CHICO	DAI-1409010
	TORNILLO ESTABILIZADOR FRONTAL DERECHO	DAI-2109016
	TORNILLO ESTABILIZADOR FRONTAL IZQUIERDO	DAI-2109017
	TORNILLO ESTABILIZADOR TRASERO	DAI-2109020
09-14	TOPE PARA AMORTIGUADOR FRONTAL IZQUIERDO Y DERECHO	2018

INSIGHT

28	APLICACIÓN / DESCRIPTION	DAI PARTS #	DAI KIT PARTS #
BASES PARA AMORTIGUADOR / STRUT MOUNTS			
10-14	BASE PARA AMORTIGUADOR FRONTAL IZQUIERDA Y DERECHA		7591-KIT



ODYSSEY

	28	APLICACIÓN / DESCRIPTION	DAI PARTS #
--	-----------	---------------------------------	--------------------

SOPORTES / TRANSMISSION & MOTOR MOUNTS

L4 2.2 L4 2.3	95-98	SOPORTE PARA MOTOR FRONTAL	6775
		SOPORTE PARA MOTOR TRASERO	6815
		SOPORTE PARA MOTOR TRASERO	6815-H
		SOPORTE PARA MOTOR IZQUIERDO	6816

V6 3.5	99-04	SOPORTE PARA MOTOR DERECHO	7050
		SOPORTE PARA TRANSMISIÓN TRASERO	7053
		SOPORTE PARA MOTOR TRASERO	7094
		SOPORTE PARA MOTOR FRONTAL	7364-H
	99-06	SOPORTE PARA TRANSMISIÓN TRASERO	7165
		SOPORTE PARA TRANSMISIÓN FRONTAL	7052
	99-10	REPUESTO PARA SOPORTE MOTOR TRASERO (7094)	7094-9
	05-06	SOPORTE PARA MOTOR DERECHO	7586
		SOPORTE PARA TRANSMISIÓN TRASERO INFERIOR	7670
	05-07	SOPORTE PARA MOTOR TRASERO	7544-EL
05-10	SOPORTE PARA MOTOR FRONTAL	7704-H	

SOPORTES TRANSMISSION & MOTOR MOUNTS



6775 6815



6815-H 6816



7050 7052



7053 7094



7094-9 7165 7364-H 7544-EL



7586 7670 7704-H



CONTINUACIÓN... ODYSSEY



 		APLICACIÓN / DESCRIPTION	DAI PARTS #
SOPORTES / TRANSMISSION & MOTOR MOUNTS			
V6 3.5	05-15	SOPORTE PARA MOTOR FRONTAL	7519-EL
	07-10	SOPORTE PARA TRANSMISIÓN TRASERO INFERIOR	7678
	07-15	SOPORTE PARA MOTOR DERECHO	7389
	11-13	SOPORTE PARA TRANSMISIÓN	7676
	11-15	SOPORTE PARA MOTOR TRASERO	7544-EL



		APLICACIÓN / DESCRIPTION	DAI PARTS #	DAI KIT PARTS #
BASES PARA AMORTIGUADOR / STRUT MOUNTS				
95-98		BASE PARA AMORTIGUADOR FRONTAL IZQUIERDA Y DERECHA	6736	6736-KIT
		BASE PARA AMORTIGUADOR FRONTAL IZQUIERDA Y DERECHA	6755	
05-10		BASE PARA AMORTIGUADOR FRONTAL IZQUIERDA Y DERECHA		7355-KIT



CONTINUACIÓN... ODYSSEY

  28		APLICACIÓN / DESCRIPTION	DAI PARTS #
MISCELÁNEOS / AUTOMOTIVE RUBBER PARTS			
99-04	BUJE PARA HORQUILLA INFERIOR GRANDE		DAI-1409005
	BUJE PARA HORQUILLA INFERIOR CHICO		DAI-1409006

**MISCELÁNEOS
AUTOMOTIVE RUBBER PARTS**



DAI-1409005



DAI-1409006

PASSPORT

SOPORTES / TRANSMISSION & MOTOR MOUNTS			
V6 3.2	96-01	SOPORTE PARA MOTOR IZQUIERDO	7686

**SOPORTES TRANSMISSION
& MOTOR MOUNTS**



7686

MISCELÁNEOS / AUTOMOTIVE RUBBER PARTS		
94-02	BUJE SUPERIOR	DAI-K-9468

**MISCELÁNEOS
AUTOMOTIVE RUBBER PARTS**



DAI-K-9468





PILOT

 		APLICACIÓN / DESCRIPTION	DAI PARTS #
SOPORTES / TRANSMISSION & MOTOR MOUNTS			
V6 3.5	03-04	SOPORTE PARA MOTOR DERECHO	7050
	03-05	SOPORTE PARA TRANSMISIÓN TRASERO	7165
		SOPORTE PARA TRANSMISIÓN FRONTAL	7052
		SOPORTE PARA TRANSMISIÓN TRASERO	7053
	03-08	SOPORTE PARA MOTOR FRONTAL	7364-H
	05-08	SOPORTE PARA MOTOR TRASERO 4X4	7724
	09-15	SOPORTE PARA MOTOR DERECHO	7586
	10-15	SOPORTE PARA TRANSMISIÓN	7676



 		APLICACIÓN / DESCRIPTION	DAI PARTS #	DAI KIT PARTS #
BASES PARA AMORTIGUADOR / STRUT MOUNTS				
03-08		BASE PARA AMORTIGUADOR FRONTAL IZQUIERDA Y DERECHA		7373-KIT



 		APLICACIÓN / DESCRIPTION	DAI PARTS #
MISCELÁNEOS / AUTOMOTIVE RUBBER PARTS			
	03-08	BUJE PARA HORQUILLA INFERIOR GRANDE	DAI-1409005
		BUJE PARA HORQUILLA INFERIOR CHICO	DAI-1409006



PRELUDE

 		APLICACIÓN / DESCRIPTION	DAI PARTS #
SOPORTES / TRANSMISSION & MOTOR MOUNTS			
L4 1.8	79-82	SOPORTE MOTOR FRONTAL	6776
L4 2.0	88-91	SOPORTE PARA MOTOR TRASERO STD.	7683
L4 2.2	92-96	SOPORTE PARA TRANSMISIÓN	6809
		SOPORTE PARA MOTOR TRASERO STD.	7683
L4 2.3	92-94	SOPORTE PARA TRANSMISIÓN	6809
	92-96	SOPORTE PARA MOTOR TRASERO STD.	7683



		APLICACIÓN / DESCRIPTION	DAI PARTS #	DAI KIT PARTS #
BASES PARA AMORTIGUADOR / STRUT MOUNTS				
83-01		BASE PARA AMORTIGUADOR FRONTAL IZQUIERDA Y DERECHA	6736	6736-KIT
		BASE PARA AMORTIGUADOR FRONTAL IZQUIERDA Y DERECHA	6755	



RIDGELINE

	 28	APLICACIÓN / DESCRIPTION	DAI PARTS #
--	--	--------------------------	-------------

SOPORTES / TRANSMISSION & MOTOR MOUNTS

V6 3.5	06-11	SOPORTE PARA MOTOR DERECHO	7050
		SOPORTE PARA MOTOR FRONTAL	7364-H
	06-14	SOPORTE PARA MOTOR TRASERO	7724

SOPORTES TRANSMISSION & MOTOR MOUNTS



7050



7364-H



7724



HYUNDAI

ACCENT

 	APLICACIÓN / DESCRIPTION	DAI PARTS #
---	--------------------------	-------------

SOPORTES / TRANSMISSION & MOTOR MOUNTS

L4 1.6	03-05	SOPORTE PARA MOTOR FRONTAL	7016
		SOPORTE PARA MOTOR FRONTAL	7030
	06-11	SOPORTE PARA MOTOR DERECHO	7616-H
		SOPORTE PARA TRANSMISIÓN	7639

L4 1.5	00-03	SOPORTE PARA TRANSMISIÓN STD.	7090
L4 1.6		SOPORTE PARA TRANSMISIÓN AUT.	7091



7616-H



7639

SOPORTES TRANSMISSION & MOTOR MOUNTS



7016



7030



7090



7091

	APLICACIÓN / DESCRIPTION	DAI PARTS #	DAI KIT PARTS #
---	--------------------------	-------------	-----------------

BASES PARA AMORTIGUADOR / STRUT MOUNTS

00-10	BASE PARA AMORTIGUADOR FRONTAL IZQUIERDA Y DERECHA	7344	
-------	--	------	--

BASES PARA AMORTIGUADOR STRUT MOUNTS



7344

 	APLICACIÓN / DESCRIPTION	DAI PARTS #
---	--------------------------	-------------

MISCELÁNEOS / AUTOMOTIVE RUBBER PARTS

95-03	BUJE PARA HORQUILLA INFERIOR GRANDE	DAI-1406089
-------	-------------------------------------	-------------

MISCELÁNEOS AUTOMOTIVE RUBBER PARTS



DAI-1406089



CONTINUACIÓN... ACCENT

 28		APLICACIÓN / DESCRIPTION	DAI PARTS #
MISCELÁNEOS / AUTOMOTIVE RUBBER PARTS			
95-03		BUJE PARA HORQUILLA INFERIOR CHICO	DAI-1406088
	99-05	TORNILLO ESTABILIZADOR FRONTAL IZQUIERDO	DAI-2106001
		TORNILLO ESTABILIZADOR FRONTAL DERECHO	DAI-2106002
06-10		BUJE PARA HORQUILLA INFERIOR CHICO (ERA)	DAI-1406030
		BUJE PARA HORQUILLA INFERIOR GRANDE (ERA)	DAI-1406031
		TORNILLO ESTABILIZADOR FRONTAL IZQUIERDO (ERA)	DAI-2106021
		TORNILLO ESTABILIZADOR FRONTAL DERECHO (ERA)	DAI-2106022

ATOS

SOPORTES / TRANSMISSION & MOTOR MOUNTS			
L4 1.0	00-04	REPUESTO PARA SOPORTE DE MOTOR FRONTAL (7127)	6951
		REPUESTO PARA SOPORTE DE TRANSMISIÓN (7245)	6952





CONTINUACIÓN... ATOS

		 28	APLICACIÓN / DESCRIPTION	DAI PARTS #
SOPORTES / TRANSMISSION & MOTOR MOUNTS				
L4 1.0	00-04		REPUESTO PARA SOPORTE DE MOTOR TRASERO (7246)	6953
			SOPORTE PARA MOTOR FRONTAL	7127
L4 1.1	05-12		SOPORTE PARA TRANSMISIÓN	7245
			SOPORTE PARA MOTOR TRASERO	7246
			REPUESTO PARA SOPORTE DE MOTOR FRONTAL Y TRASERO	7550-9
			REPUESTO PARA SOPORTE DE TRANSMISIÓN	7551-9
	00-12		SOPORTE PARA PALANCA DE VELOCIDADES	7087



		 28	APLICACIÓN / DESCRIPTION	DAI PARTS #	DAI KIT PARTS #
BASES PARA AMORTIGUADOR / STRUT MOUNTS					
00-12			BASE PARA AMORTIGUADOR FRONTAL IZQUIERDA Y DERECHA	6954	



		 28	APLICACIÓN / DESCRIPTION	DAI PARTS #
CUBRE POLVOS / C.V. BOOTS				
	00-04		CUBRE POLVO IZQUIERDO Y DERECHO LADO RUEDA	6313



CONTINUACIÓN... ATOS

	28	APLICACIÓN / DESCRIPTION	DAI PARTS #
CUBRE POLVOS / C.V. BOOTS			
00-04		CUBRE POLVO IZQUIERDO Y DERECHO LADO CAJA (CON TRIPOIDE)	6343
		CUBRE POLVO IZQUIERDO Y DERECHO DE DIRECCIÓN	6362
05-12		CUBRE POLVO IZQUIERDO Y DERECHO LADO RUEDA	63120
		CUBRE POLVO IZQUIERDO Y DERECHO LADO CAJA (TRIPOIDE)	63121



MISCELÁNEOS / AUTOMOTIVE RUBBER PARTS			
00-12		TOPE PARA AMORTIGUADOR FRONTAL IZQUIERDO Y DERECHO	2011
		BUJE PARA EJE TRASERO	DAI-1406120
		BUJE PARA HORQUILLA INFERIOR CHICO	DAI-1406006
		BUJE PARA HORQUILLA INFERIOR GRANDE	DAI-1406013
		GOMA PARA BARRA ESTABILIZADORA	DAI-1406065
		TORNILLO ESTABILIZADOR FRONTAL	DAI-2106015



ATTITUDE

 		APLICACIÓN / DESCRIPTION	DAI PARTS #
SOPORTES / TRANSMISSION & MOTOR MOUNTS			
L4 1.4 L4 1.6	06-11	SOPORTE PARA MOTOR FRONTAL	7343
		SOPORTE PARA MOTOR TRASERO	7346
		SOPORTE PARA MOTOR DERECHO	7616-H
		SOPORTE PARA TRANSMISIÓN	7639
12-15		SOPORTE PARA MOTOR TRASERO	7437
		SOPORTE PARA MOTOR DERECHO	7486-H
		SOPORTE PARA TRANSMISIÓN	7488

SOPORTES TRANSMISSION & MOTOR MOUNTS

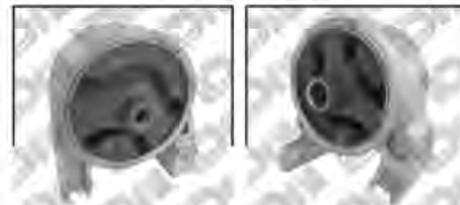

7343 **7346**



7437 **7486-H**





7488 **7616-H** **7639**

	APLICACIÓN / DESCRIPTION	DAI PARTS #	DAI KIT PARTS #
BASES PARA AMORTIGUADOR / STRUT MOUNTS			
06-11	BASE PARA AMORTIGUADOR FRONTAL IZQUIERDA Y DERECHA	7344	

BASES PARA AMORTIGUADOR STRUT MOUNTS



7344

 		APLICACIÓN / DESCRIPTION	DAI PARTS #
MISCELÁNEOS / AUTOMOTIVE RUBBER PARTS			
	06-11	BUJE PARA HORQUILLA INFERIOR CHICO	DAI-1406030
		BUJE PARA HORQUILLA INFERIOR GRANDE	DAI-1406031

MISCELÁNEOS AUTOMOTIVE RUBBER PARTS



DAI-1406030 **DAI-1406031**



CONTINUACIÓN... ATTITUDE

28		APLICACIÓN / DESCRIPTION	DAI PARTS #
MISCELÁNEOS / AUTOMOTIVE RUBBER PARTS			
06-11		TORNILLO ESTABILIZADOR FRONTAL IZQUIERDO	DAI-2106021
		TORNILLO ESTABILIZADOR FRONTAL DERECHO	DAI-2106022

AZERA

SOPORTES / TRANSMISSION & MOTOR MOUNTS			
V6 3.8	06-11	SOPORTE PARA MOTOR DERECHO	7487-H
		SOPORTE PARA MOTOR FRONTAL	7490

ELANTRA

SOPORTES / TRANSMISSION & MOTOR MOUNTS			
L4 2.0	04-06	SOPORTE PARA TRANSMISIÓN	7527
		SOPORTE PARA MOTOR FRONTAL	7528
		SOPORTE PARA MOTOR TRASERO	7529



EXCEL

 		APLICACIÓN / DESCRIPTION	DAI PARTS #
SOPORTES / TRANSMISSION & MOTOR MOUNTS			
L4 1.5	86-89	SOPORTE DE TORSIÓN	6904



MISCELÁNEOS / AUTOMOTIVE RUBBER PARTS			
	86-95	BUJE YUGO INTERNO (PUENTE TRASERO)	9176
		BUJE YUGO EXTERNO (PUENTE TRASERO)	9177



H-100

SOPORTES / TRANSMISSION & MOTOR MOUNTS			
L4 2.4	03-10	SOPORTE TRANSMISIÓN	7024
		SOPORTE PARA MOTOR IZQUIERDO Y DERECHO	7095



I10

SOPORTES / TRANSMISSION & MOTOR MOUNTS			
L4 1.1	10-16	SOPORTE PARA TRANSMISIÓN	7439
		SOPORTE PARA MOTOR DERECHO	7485



CONTINUACIÓN... 110

28		APLICACIÓN / DESCRIPTION	DAI PARTS #
SOPORTES / TRANSMISSION & MOTOR MOUNTS			
L4 1.1	10-16	SOPORTE PARA MOTOR TRASERO	7575



28		APLICACIÓN / DESCRIPTION	DAI PARTS #	DAI KIT PARTS #
BASES PARA AMORTIGUADOR / STRUT MOUNTS				
10-16		BASE PARA AMORTIGUADOR FRONTAL IZQUIERDA Y DERECHA	7427	7427-KIT
		BALERO PARA BASE DE AMORTIGUADOR FRONTAL IZQUIERDA Y DERECHA	6139	



28		APLICACIÓN / DESCRIPTION	DAI PARTS #
CUBRE POLVOS / C.V. BOOTS			
	10-16	MACHETA Ó CUBRE POLVO IZQUIERDO Y DERECHO LADO CAJA (CON TRIPOIDE)	63154
		MACHETA Ó CUBRE POLVO IZQUIERDO Y DERECHO LADO RUEDA	63155



CONTINUACIÓN... i10

 		APLICACIÓN / DESCRIPTION	DAI PARTS #
MISCELÁNEOS / AUTOMOTIVE RUBBER PARTS			
10-16		TORNILLO ESTABILIZADOR FRONTAL (CORTO)	DAI-2108001
		BUJE PARA HORQUILLA INFERIOR CHICO	DAI-1406030
12-14		BUJE PARA HORQUILLA CHICO	DAI-1406088

**MISCELÁNEOS
AUTOMOTIVE RUBBER PARTS**



DAI-2108001



DAI-1406030



DAI-1406088

ix35

SOPORTES / TRANSMISSION & MOTOR MOUNTS			
L4 2.0 L4 2.4	14-15	SOPORTE PARA MOTOR TRASERO	7526

**SOPORTES TRANSMISSION
& MOTOR MOUNTS**



7526

SONATA

SOPORTES / TRANSMISSION & MOTOR MOUNTS			
L4 2.4	06-08	SOPORTE PARA MOTOR DERECHO	7487-H
	06-11	SOPORTE PARA TRANSMISIÓN STD.	7489
		SOPORTE PARA MOTOR FRONTAL	7490
V6 3.3	06-10	SOPORTE PARA MOTOR FRONTAL	7490

**SOPORTES TRANSMISSION
& MOTOR MOUNTS**



7487-H



7489



7490



TUCSON

		APLICACIÓN / DESCRIPTION	DAI PARTS #
SOPORTES / TRANSMISSION & MOTOR MOUNTS			
L4 2.0 L4 2.4	09-15	SOPORTE PARA MOTOR TRASERO	7526

VELOSTER

SOPORTES / TRANSMISSION & MOTOR MOUNTS			
L4 1.6	12-14	SOPORTE PARA MOTOR TRASERO	7437
		SOPORTE PARA MOTOR DERECHO	7486-H
		SOPORTE PARA TRANSMISIÓN STD.	7488

VERNA

SOPORTES / TRANSMISSION & MOTOR MOUNTS			
L4 1.5 L4 1.6	04-06	SOPORTE PARA MOTOR FRONTAL AUT.	7016
		SOPORTE PARA MOTOR FRONTAL	7030



CONTINUACIÓN... VERNA

 		APLICACIÓN / DESCRIPTION	DAI PARTS #
SOPORTES / TRANSMISSION & MOTOR MOUNTS			
L4 1.5 L4 1.6	04-06	SOPORTE PARA MOTOR TRASERO	7089
		SOPORTE PARA TRANSMISIÓN STD.	7090
		SOPORTE PARA TRANSMISIÓN AUT.	7091



CUBRE POLVOS / C.V. BOOTS			
	04-06	CUBRE POLVO IZQUIERDO Y DERECHO LADO RUEDA	6305
		CUBRE POLVO IZQUIERDO Y DERECHO LADO CAJA	6346
		CUBRE POLVO IZQUIERDO Y DERECHO DE DIRECCIÓN STD.	6345



MISCELÁNEOS / AUTOMOTIVE RUBBER PARTS			
	04-06	BUJE PARA HORQUILLA INFERIOR GRANDE	DAI-1406089
		BUJE PARA HORQUILLA INFERIOR CHICO	DAI-1406088



CONTINUACIÓN... VERNA

  28		APLICACIÓN / DESCRIPTION	DAI PARTS #	MISCELÁNEOS / AUTOMOTIVE RUBBER PARTS	
MISCELÁNEOS / AUTOMOTIVE RUBBER PARTS					
04-06		TORNILLO ESTABILIZADOR FRONTAL IZQUIERDO	DAI-2106001		
		TORNILLO ESTABILIZADOR FRONTAL DERECHO	DAI-2106002		
			DAI-2106001	DAI-2106002	



INFINITI

G20

		APLICACIÓN / DESCRIPTION	DAI PARTS #
SOPORTES / TRANSMISSION & MOTOR MOUNTS			
L4 2.0	99-02	SOPORTE PARA TRANSMISIÓN AUT.	7040
		REPUESTO PARA SOPORTE DE TRANSMISIÓN (7040, 7032 Y 7265)	7217-9



I30

SOPORTES / TRANSMISSION & MOTOR MOUNTS			
V6 3.0	96-01	SOPORTE PARA TRANSMISIÓN AUT.	7040
		SOPORTE PARA MOTOR FRONTAL	7477
		SOPORTE MOTOR TRASERO	7538
	96-99	SOPORTE PARA MOTOR DERECHO	7265
		REPUESTO PARA SOPORTE DE TRANSMISIÓN (7040)	7217-9
		REPUESTO PARA SOPORTE DE MOTOR DERECHO (7032 Y 7265)	



	APLICACIÓN / DESCRIPTION	DAI PARTS #	DAI KIT PARTS #
BASES PARA AMORTIGUADOR / STRUT MOUNTS			
96-99	BASE PARA AMORTIGUADOR TRASERA IZQUIERDA Y DERECHA		7291-KIT



CONTINUACIÓN... I30

28	APLICACIÓN / DESCRIPTION	DAI PARTS #	DAI KIT PARTS #
BASES PARA AMORTIGUADOR / STRUT MOUNTS			
96-99	BASE PARA AMORTIGUADOR FRONTAL IZQUIERDA Y DERECHA		7298-KIT
00-04	BASE PARA AMORTIGUADOR TRASERA IZQUIERDA Y DERECHA		7637-KIT
02-04	BASE PARA AMORTIGUADOR FRONTAL IZQUIERDA Y DERECHA		7300-KIT

**BASES PARA AMORTIGUADOR
STRUT MOUNTS**

7298-KIT

7300-KIT

7637-KIT
I35

28	APLICACIÓN / DESCRIPTION	DAI PARTS #
SOPORTES / TRANSMISSION & MOTOR MOUNTS		
V6 3.0	96-01	SOPORTE PARA TRANSMISIÓN AUT. 7040
V6 3.5	02-04	SOPORTE PARA MOTOR DERECHO 7265
	03-06	REPUESTO SOPORTE PARA MOTOR FRONTAL Y TRASERO 7160-9

**SOPORTES TRANSMISSION
& MOTOR MOUNTS**

7040

7160-9

7265

CONTINUACIÓN... I35

28	APLICACIÓN / DESCRIPTION	DAI PARTS #	DAI KIT PARTS #
BASES PARA AMORTIGUADOR / STRUT MOUNTS			
96-99	BASE PARA AMORTIGUADOR FRONTAL IZQUIERDA Y DERECHA		7298-KIT
00-04	BASE PARA AMORTIGUADOR TRASERA IZQUIERDA Y DERECHA		7637-KIT
02-04	BASE PARA AMORTIGUADOR FRONTAL IZQUIERDA Y DERECHA	7300	



QX 4

BASES PARA AMORTIGUADOR / STRUT MOUNTS			
97-03	BASE PARA AMORTIGUADOR FRONTAL IZQUIERDA Y DERECHA		7635-KIT



QX 56

28	APLICACIÓN / DESCRIPTION	DAI PARTS #	
SOPORTES / TRANSMISSION & MOTOR MOUNTS			
V6 5.6	01-03	SOPORTE PARA TRANSMISIÓN (4X4)	7274
		SOPORTE PARA MOTOR IZQUIERDO Y DERECHO	7275



CONTINUACIÓN... QX 56

	 28	APLICACIÓN / DESCRIPTION	DAI PARTS #
SOPORTES / TRANSMISSION & MOTOR MOUNTS			
V6 5.6	01-03	SOPORTE PARA TRANSMISIÓN (4X2)	7324



ISUZU

AMIGO

  28		APLICACIÓN / DESCRIPTION	DAI PARTS #
SOPORTES / TRANSMISSION & MOTOR MOUNTS			
L4 2.3	89-94	SOPORTE PARA MOTOR DERECHO	7685
L4 2.6		SOPORTE PARA MOTOR IZQUIERDO	7748



MISCELÁNEOS / AUTOMOTIVE RUBBER PARTS			
	89-97	BUJE SUPERIOR (4X2)	DAI-K-9468
		BUJE PARA MUELLE (POLIURETANO)	9160



ASCENDER

SOPORTES / TRANSMISSION & MOTOR MOUNTS			
L6 4.2	03-07	SOPORTE PARA MOTOR IZQUIERDO Y DERECHO	7244-H
		SOPORTE PARA TRANSMISIÓN AUT.	7311



HOMBRE

	28	APLICACIÓN / DESCRIPTION	DAI PARTS #
--	-----------	---------------------------------	--------------------

SOPORTES / TRANSMISSION & MOTOR MOUNTS

L4 2.2	96-00	SOPORTE PARA MOTOR IZQUIERDO	7003
		SOPORTE PARA MOTOR DERECHO	7004
		REPUESTO PARA SOPORTE DE MOTOR IZQUIERDO Y DERECHO (7003 Y 7004)	7097
		SOPORTE PARA TRANSMISIÓN AUT. 4 VEL.	7079
		SOPORTE PARA TRANSMISIÓN STD. 5 VEL.	1932

V6 4.3	97-00	SOPORTE PARA MOTOR IZQUIERDO Y DERECHO	6914
		SOPORTE PARA TRANSMISIÓN (4X4)	6874
		SOPORTE PARA TRANSMISIÓN TRACCIÓN TRASERA	6800

SOPORTES TRANSMISSION & MOTOR MOUNTS

1932
6800

6874
6914

7003
7004
7079
7097
MISCELÁNEOS / AUTOMOTIVE RUBBER PARTS

96-00	BUJES PARA HORQUILLA SUPERIOR (4X4)	DAI-K-6283
-------	-------------------------------------	------------

**MISCELÁNEOS
AUTOMOTIVE RUBBER PARTS**

DAI-K-6283

OASIS

 		APLICACIÓN / DESCRIPTION	DAI PARTS #
SOPORTES / TRANSMISSION & MOTOR MOUNTS			
L4 2.2 L4 2.3	96-00	SOPORTE PARA MOTOR FRONTAL	6775
		SOPORTE PARA TRANSMISIÓN	6809
		SOPORTE PARA MOTOR TRASERO	6815
		SOPORTE PARA MOTOR TRASERO	6815-H
		SOPORTE PARA MOTOR IZQUIERDO	6816



PICK UP

SOPORTES / TRANSMISSION & MOTOR MOUNTS			
L4 2.3 L4 2.6	88-95	SOPORTE PARA MOTOR DERECHO	7685
		SOPORTE PARA MOTOR IZQUIERDO	7748



MISCELÁNEOS / AUTOMOTIVE RUBBER PARTS			
	73-08	COPLÉ PARA DIRECCIÓN (SINFÍN DE .625" NO REQUIERE PERNOS)	617
		GALLETAS PARA DIRECCIÓN STD. Y HID. (NO REQUIERE PERNOS CON BUJES COMPLETO 617)	629



CONTINUACIÓN... PICK UP

	 28	APLICACIÓN / DESCRIPTION	DAI PARTS #
MISCELÁNEOS / AUTOMOTIVE RUBBER PARTS			
	88-97	BUJE SUPERIOR (4X2 Y 4X4)	DAI-K-9468

**MISCELÁNEOS
AUTOMOTIVE RUBBER PARTS**



DAI-K-9468

RODEO

SOPORTES / TRANSMISSION & MOTOR MOUNTS			
V6 3.2	95-97	SOPORTE PARA MOTOR IZQUIERDO	7686

**SOPORTES TRANSMISSION
& MOTOR MOUNTS**



7686

MISCELÁNEOS / AUTOMOTIVE RUBBER PARTS			
	89-97	BUJE PARA MUELLE (POLIURETANO)	9160

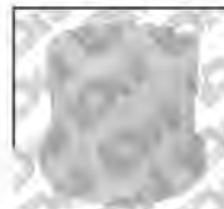

**MISCELÁNEOS
AUTOMOTIVE RUBBER PARTS**



9160



TROOPER

		 28	APLICACIÓN / DESCRIPTION	DAI PARTS #
SOPORTES / TRANSMISSION & MOTOR MOUNTS				
L4 2.2	81-86		SOPORTE PARA MOTOR IZQUIERDO (II PICK UP)	6955
L4 2.3	1987		SOPORTE PARA MOTOR DERECHO	7685
L4 2.6	88-91			
V6 2.8				
V6 3.2	96-97		SOPORTE PARA MOTOR IZQUIERDO	7686
V6 3.5	98-02			
L4 2.2	1987		SOPORTE PARA MOTOR IZQUIERDO	7748
L4 2.3				
L4 2.6				
V6 2.8				
V6 3.0				

SOPORTES TRANSMISSION & MOTOR MOUNTS



6955



7685



7686



7748

MISCELÁNEOS / AUTOMOTIVE RUBBER PARTS

	87-02	BUJE SUPERIOR (4X4)	DAI-K-9468
		BUJE PARA MUELLE (POLIURETANO)	9160
	98-02	BUJE PARA MUELLE (POLIURETANO)	9126

MISCELÁNEOS AUTOMOTIVE RUBBER PARTS



DAI-K-9468



9126



UNIVERSAL

	28	APLICACIÓN / DESCRIPTION	DAI PARTS #
MISCELÁNEOS / AUTOMOTIVE RUBBER PARTS			
		BUJE PARA MUELLE (POLIURETANO)	9166

**MISCELÁNEOS
AUTOMOTIVE RUBBER PARTS**



9166

VEHICROSS

SOPORTES / TRANSMISSION & MOTOR MOUNTS			
V6 3.5	99-02	SOPORTE PARA MOTOR IZQUIERDO	7686

**SOPORTES TRANSMISSION
& MOTOR MOUNTS**



7686



JAGUAR

S-TYPE

  28		APLICACIÓN / DESCRIPTION	DAI PARTS #
SOPORTES / TRANSMISSION & MOTOR MOUNTS			
V6 3.0	00-08	SOPORTE PARA MOTOR IZQUIERDO Y DERECHO	7566-H
V8 4.0	01-07		



X-TYPE

SOPORTES / TRANSMISSION & MOTOR MOUNTS			
V6 2.5	02-07	SOPORTE PARA TRANSMISIÓN	7185
V6 3.0		SOPORTE PARA MOTOR TRASERO	7186



MISCELÁNEOS / AUTOMOTIVE RUBBER PARTS			
	02-08	TORNILLO ESTABILIZADOR FRONTAL	DAI-2108005



JEEP

CHEROKEE

	 28	APLICACIÓN / DESCRIPTION	DAI PARTS #
SOPORTES / TRANSMISSION & MOTOR MOUNTS			
L6 4.0	93-95	SOPORTE PARA TRANSMISIÓN AUT.	7241
L4 2.5 L6 4.0	84-96	SOPORTE PARA MOTOR IZQUIERDO Y DERECHO	6768
		SOPORTE PARA TRANSMISIÓN AUT. Y STD.	6831
		SOPORTE PARA MOTOR DERECHO	6832
		SOPORTE PARA TRANSMISIÓN AUT.	6833
L6 4.2	74-83	SOPORTE PARA TRANSMISIÓN	1577
V8 5.0	72-83	SOPORTE PARA MOTOR IZQUIERDO Y DERECHO	6773
V8 5.9	74-83	SOPORTE PARA TRANSMISIÓN	1577



CUBRE POLVOS / C.V. BOOTS		
	84-98	CUBRE POLVO IZQUIERDO Y DERECHO LADO RUEDA
		6350



CONTINUACIÓN... CHEROKEE

 28		APLICACIÓN / DESCRIPTION	DAI PARTS #
MISCELÁNEOS / AUTOMOTIVE RUBBER PARTS			
V6 4.0	91-98	TORNILLO ESTABILIZADOR FRONTAL (4X4)	DAI-K-3174
		TORNILLO ESTABILIZADOR FRONTAL (4X4)	DAI-K-3196
	02-05	GOMA PARA BARRA ESTABILIZADORA	64698
	05-09	GOMA PARA BARRA ESTABILIZADORA	64701

C-J

SOPORTES / TRANSMISSION & MOTOR MOUNTS			
L6 4.2 L6 4.6	77-85	SOPORTE PARA MOTOR IZQUIERDO	1711
		SOPORTE PARA MOTOR DERECHO	1777
		SOPORTE PARA TRANSMISIÓN	1856
		SOPORTE PARA MOTOR IZQUIERDO	1710
V8 4.8	72-79	SOPORTE PARA MOTOR IZQUIERDO Y DERECHO	6773



CJ3

 		APLICACIÓN / DESCRIPTION	DAI PARTS #
SOPORTES / TRANSMISSION & MOTOR MOUNTS			
L4 2.2	59-71	SOPORTE PARA MOTOR FRONTAL IZQUIERDO Y DERECHO	1149



COMANCHE

SOPORTES / TRANSMISSION & MOTOR MOUNTS			
L4 2.5	86-90	SOPORTE PARA TRANSMISIÓN AUT.	6833
	86-92	SOPORTE PARA TRANSMISIÓN AUT. Y STD.	6831
		SOPORTE PARA MOTOR DERECHO	6832
		SOPORTE PARA MOTOR IZQUIERDO	7228
L6 4.0	87-90	SOPORTE PARA TRANSMISIÓN	6833
V6 2.8	1986	SOPORTE PARA TRANSMISIÓN AUT. Y STD.	6831
		SOPORTE PARA MOTOR IZQUIERDO	7228



MISCELÁNEOS / AUTOMOTIVE RUBBER PARTS			
	91-92	TORNILLO ESTABILIZADOR DELANTERO IZQUIERDO Y DERECHO	DAI-K-3174



COMMANDER

		APLICACIÓN / DESCRIPTION	DAI PARTS #
SOPORTES / TRANSMISSION & MOTOR MOUNTS			
V8 5.7	2009	SOPORTE PARA MOTOR IZQUIERDO <i>LIMITED, OVERLAND</i>	7790
	2010	SOPORTE PARA MOTOR IZQUIERDO <i>LIMITED, SPORT</i>	
	2009	SOPORTE PARA MOTOR <i>LIMITED, OVERLAND</i>	7791
	2010	SOPORTE PARA MOTOR IZQUIERDO <i>LIMITED, SPORT</i>	



		APLICACIÓN / DESCRIPTION	DAI PARTS #	DAI KIT PARTS #
BASES PARA AMORTIGUADOR / STRUT MOUNTS				
05-10		BASE PARA AMORTIGUADOR FRONTAL IZQUIERDA Y DERECHA		7369-KIT



		APLICACIÓN / DESCRIPTION	DAI PARTS #
MISCELÁNEOS / AUTOMOTIVE RUBBER PARTS			
	05-10	BUJE PARA HORQUILLA INFERIOR TRASERO	DAI-1406068
		BUJE PARA SOPORTE DE DIFERENCIAL	DAI-2906208

COMPASS

SOPORTES / TRANSMISSION & MOTOR MOUNTS			
L4 2.0	07-12	SOPORTE PARA MOTOR TRASERO	7414
	07-17	SOPORTE PARA TRANSMISIÓN STD.	7749



CONTINUACIÓN... COMPASS

		APLICACIÓN / DESCRIPTION	DAI PARTS #
---	---	---------------------------------	--------------------

SOPORTES / TRANSMISSION & MOTOR MOUNTS

L4 2.0 L4 2.4	07-11	SOPORTE PARA MOTOR FRONTAL	7208
		REPUESTO PARA SOPORTE MOTOR FRONTAL (7208)	7208-9
L4 2.4	07-12	SOPORTE PARA MOTOR DERECHO	7348
		REPUESTO PARA SOPORTE MOTOR DERECHO (7348)	7348-9
		TRANSMISIÓN AUT. Y STD. (7358)	
		SOPORTE PARA TRANSMISIÓN AUT.	7358
		SOPORTE PARA MOTOR TRASERO STD.	7359
		REPUESTO PARA SOPORTE DE MOTOR TRASERO AUT.	7414-9
	07-17	SOPORTE PARA MOTOR TRASERO	7765
	SOPORTE PARA MOTOR TRASERO	7414	
	SOPORTE PARA TRANSMISIÓN STD.	7749	

SOPORTES TRANSMISSION & MOTOR MOUNTS



7208

7208-9



7348

7348-9



7358

7359



7414

7414-9

7749

7765

	APLICACIÓN / DESCRIPTION	DAI PARTS #	DAI KIT PARTS #
---	---------------------------------	--------------------	------------------------

BASES PARA AMORTIGUADOR / STRUT MOUNTS

07-15	BASE PARA AMORTIGUADOR FRONTAL IZQUIERDA Y DERECHA	7332	
-------	--	------	--

BASES PARA AMORTIGUADOR STRUT MOUNTS



7332



CONTINUACIÓN... COMPASS

	28	APLICACIÓN / DESCRIPTION	DAI PARTS #
CUBRE POLVOS / C.V. BOOTS			
07-15		CUBRE POLVO IZQUIERDO Y DRECHO LADO CAJA STD. (CON TRIPOIDE)	63164
		CUBRE POLVO LADO RUEDA IZQUIERDO Y DERECHO	63165
		CUBRE POLVO LADO CAJA AUT. IZQUIERDO Y DERECHO (CON TRIPOIDE)	63166



MISCELÁNEOS / AUTOMOTIVE RUBBER PARTS			
07-11		BUJE PARA HORQUILLA GRANDE	DAI-1415002
		BUJE PARA HORQUILLA INFERIOR CHICO	DAI-1415001
		TORNILLO ESTABILIZADOR	DAI-2106016
07-12		KIT DE BUJES PARA SUSPENSIÓN TRASERA EN POLIURETANO 4 BUJES CHICOS, D. INT. 0.480" D. EXT. 1.575", ALTURA 1.650" 2 BUJES GRANDES D. INT. 0.480" D. EXT. 1.655", ALTURA 1.650"	9802



CONTINUACIÓN... COMPASS

	 28	APLICACIÓN / DESCRIPTION	DAI PARTS #
MISCELÁNEOS / AUTOMOTIVE RUBBER PARTS			
	07-12	BUJE PARA SUSPENSIÓN TRASERA GRANDE D. INT. 0.480" D. EXT. 1.655" ALTURA 1.650"	9802-1
		BUJE PARA SUSPENSIÓN TRASERA CHICO D. INT. 0.480" D. EXT. 1.575" ALTURA 1.650"	9802-2
	07-14	BUJE PARA EJE TRASERO	64821



GRAND CHEROKKE

SOPORTES / TRANSMISSION & MOTOR MOUNTS			
L6 4.0	93-98	SOPORTE PARA MOTOR IZQUIERDO	6882
		SOPORTE PARA MOTOR DERECHO	6881
		REPUESTO PARA SOPORTES DE MOTOR IZQUIERDO Y DERECHO (6883, 6897, 6881 Y 6882)	7031-9
	93-95	SOPORTE PARA TRANSMISIÓN AUT., 4 VEL.	7241
	96-98	SOPORTE PARA TRANSMISIÓN	6949



CONTINUACIÓN... GRAND CHEROKKE

 		APLICACIÓN / DESCRIPTION	DAI PARTS #
SOPORTES / TRANSMISSION & MOTOR MOUNTS			
V8 4.7	99-04	SOPORTE PARA MOTOR DERECHO	7272
V8 5.2	95-98	SOPORTE PARA MOTOR DERECHO	6883
		SOPORTE PARA MOTOR IZQUIERDO	6897
		SOPORTE PARA MOTOR DERECHO	6881
		SOPORTE PARA MOTOR IZQUIERDO	6882
		SOPORTE PARA TRANSMISIÓN	6949
		REPUESTO PARA SOPORTES DE MOTOR IZQUIERDO Y DERECHO (6883, 6897, 6881 Y 6882)	7031-9
	99-04	SOPORTE PARA MOTOR DERECHO	7272



	APLICACIÓN / DESCRIPTION	DAI PARTS #	DAI KIT PARTS #
BASES PARA AMORTIGUADOR / STRUT MOUNTS			
05-10	BASE PARA AMORTIGUADOR FRONTAL IZQUIERDA Y DERECHA		7369-KIT



CONTINUACIÓN... GRAND CHEROKKE

 		APLICACIÓN / DESCRIPTION	DAI PARTS #
MISCELÁNEOS / AUTOMOTIVE RUBBER PARTS			
	93-98	TORNILLO ESTABILIZADOR (5", 1542.4 mm 6 cil.)	6100
		TORNILLO ESTABILIZADOR (5", 1542.4 mm EQUIPO ORIGINAL)	6104
	05-09	GOMA PARA BARRA ESTABILIZADORA	64701
	00-06	GOMA PARA BARRA ESTABILIZADORA	64723
L6 4.0	93-98	BUJE INFERIOR (4X2)	DAI-K-3167-A
V6 4.0		BUJE INFERIOR	
V8 5.2		BUJE INFERIOR (4X2)	
V8 5.2		BUJE INFERIOR (4X2 Y 4X4)	
V6 4.0	91-98	TORNILLO ESTABILIZADOR FRONTAL (4X2 Y 4X4)	DAI-K-3174
V8 5.2	93-98	TORNILLO ESTABILIZADOR FRONTAL (4X2 Y 4X4)	DAI-K-3196
V6 4.0	91-98	TORNILLO ESTABILIZADOR FRONTAL (4X2 Y 4X4)	DAI-K-3196
V8 5.2	93-98	TORNILLO ESTABILIZADOR FRONTAL (4X2 Y 4X4)	DAI-K-3196
V8 5.2	93-98	GOMA PARA BARRA ESTABILIZADORA (4X2)	64698
V6 4.0		GOMA PARA BARRA ESTABILIZADORA (4X2)	
	05-10	BUJE PARA HORQUILLA INFERIOR TRASERO	DAI-1406068
		BUJE PARA SOPORTE DE DIFERENCIAL	DAI-2906208

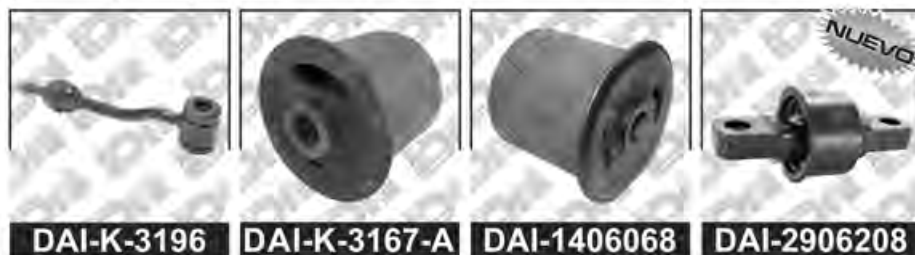

GRAND CHEROKEE SPORT WAGON

 28	APLICACIÓN / DESCRIPTION	DAI PARTS #
MISCELÁNEOS / AUTOMOTIVE RUBBER PARTS		
91-01	TORNILLO ESTABILIZADOR FRONTAL	DAI-K-3174

LIBERTY

SOPORTES / TRANSMISSION & MOTOR MOUNTS			
V6 3.7	02-07	SOPORTE PARA TRANSMISIÓN (4X4)	7188
		SOPORTE PARA TRANSMISIÓN AUT.	7189
		SOPORTE PARA TRANSMISIÓN STD.	7190
	02-03	SOPORTE PARA TRANSMISIÓN AUT.	7459



 28	APLICACIÓN / DESCRIPTION	DAI PARTS #	DAI KIT PARTS #
BASES PARA AMORTIGUADOR / STRUT MOUNTS			
02-07	BASE AMORTIGUADOR FRONTAL IZQUIERDA		7370-KIT
	BASE AMORTIGUADOR FRONTAL DERECHA		7371-KIT





CONTINUACIÓN... LIBERTY



		APLICACIÓN / DESCRIPTION	DAI PARTS #
MISCELÁNEOS / AUTOMOTIVE RUBBER PARTS			
		GOMA PARA BARRA ESTABILIZADORA (4X2 Y 4X4)	64699
	02-07	BUJE INFERIOR (4X2 Y 4X4)	DAI-K-3167-A
		BUJE PARA HORQUILLA INFERIOR TRASERO (4X2 Y 4X4)	DAI-1406068
	08-12	BUJE PARA HORQUILLA INFERIOR TRASERO (4X2)	



NITRO

		APLICACIÓN / DESCRIPTION	DAI PARTS #	DAI KIT PARTS #
BASES PARA AMORTIGUADOR / STRUT MOUNTS				
	08-12	BASE AMORTIGUADOR FRONTAL IZQUIERDA		7370-KIT
		BASE AMORTIGUADOR FRONTAL DERECHA		7371-KIT



		APLICACIÓN / DESCRIPTION	DAI PARTS #
MISCELÁNEOS / AUTOMOTIVE RUBBER PARTS			
	06-12	BUJE PARA HORQUILLA INFERIOR TRASERO	DAI-1406068



PATRIOT

		APLICACIÓN / DESCRIPTION	DAI PARTS #
--	---	--------------------------	-------------

SOPORTES / TRANSMISSION & MOTOR MOUNTS

L4 2.0	07-12	SOPORTE PARA MOTOR FRONTAL	7208
	07-17	SOPORTE PARA TRANSMISION STD.	7749
	09-16	SOPORTE PARA MOTOR TRASERO	7414

L4 2.4	07-12	SOPORTE PARA MOTOR DERECHO	7348
		SOPORTE PARA MOTOR FRONTAL	7208
		REPUESTO PARA SOPORTE MOTOR DERECHO (7348) TRANSMISIÓN AUT. Y STD. (7358)	7348-9
		SOPORTE PARA TRANSMISIÓN AUT.	7358
		SOPORTE PARA MOTOR TRASERO	7359
		REPUESTO PARA SOPORTE DE MOTOR TRASERO AUT.	7414-9
	07-11	SOPORTE PARA MOTOR TRASERO	7765
	07-17	SOPORTE PARA TRANSMISIÓN STD.	7749
	09-16	SOPORTE PARA MOTOR TRASERO	7414

**SOPORTES
TRANSMISSION & MOTOR MOUNTS**

7208

7348

7348-9

7358

7359

7414

7414-9

7749

7765

	APLICACIÓN / DESCRIPTION	DAI PARTS #	DAI KIT PARTS #
--	--------------------------	-------------	-----------------



BASES PARA AMORTIGUADOR / STRUT MOUNTS

07-15	BASE PARA AMORTIGUADOR FRONTAL IZQUIERDA Y DERECHA	7332	
-------	--	------	--

**BASES PARA AMORTIGUADOR
STRUT MOUNTS**

7332

CONTINUACIÓN... PATRIOT

	 28	APLICACIÓN / DESCRIPTION	DAI PARTS #
CUBRE POLVOS / C.V. BOOTS			
	07-15	CUBRE POLVO IZQUIERDO Y DRECHO LADO CAJA STD. (CON TRIPOIDE)	63164
		CUBRE POLVO LADO RUEDA IZQUIERDO Y DERECHO	63165
		CUBRE POLVO LADO CAJA AUT. IZQUIERDO Y DERECHO (CON TRIPOIDE)	63166



MISCELÁNEOS / AUTOMOTIVE RUBBER PARTS			
	07-12	KIT DE BUJES PARA SUSPENSIÓN TRASERA EN POLIURETANO 4 BUJES CHICOS, D. INT. 0.480" D. EXT. 1.575", ALTURA 1.650" 2 BUJES GRANDES D. INT. 0.480" D. EXT. 1.655", ALTURA 1.650"	9802
		BUJE PARA SUSPENSIÓN TRASERA GRANDE D. INT. 0.480" D. EXT. 1.655" ALTURA 1.650"	9802-1
		BUJE PARA SUSPENSIÓN TRASERA CHICO D. INT. 0.480" D. EXT. 1.575" ALTURA 1.650"	9802-2
		BUJE PARA HORQUILLA INFERIOR CHICO	DAI-1415001
		BUJE PARA HORQUILLA GRANDE	DAI-1415002
	07-14	BUJE PARA EJE TRASERO	64821
	07-15	TORNILLO ESTABILIZADOR	DAI-2106016



WAGONEER

	28	APLICACIÓN / DESCRIPTION	DAI PARTS #
SOPORTES / TRANSMISSION & MOTOR MOUNTS			
L4 2.1	1985	SOPORTE PARA TRANSMISIÓN STD.	6831
		SOPORTE PARA TRANSMISIÓN AUT.	6833
		SOPORTE PARA MOTOR IZQUIERDO Y DERECHO	7228
L4 2.5	84-87	SOPORTE PARA TRANSMISIÓN STD.	6831
		SOPORTE PARA MOTOR DERECHO	6832
		SOPORTE PARA TRANSMISIÓN AUT.	6833
		SOPORTE PARA MOTOR IZQUIERDO Y DERECHO	7228
L4 4.0	87-90	SOPORTE PARA MOTOR IZQUIERDO Y DERECHO	6768
		SOPORTE PARA TRANSMISIÓN	6833
L6 4.2 L6 4.6	77-85	SOPORTE PARA MOTOR IZQUIERDO	1711
		SOPORTE PARA MOTOR IZQUIERDO	1710
		SOPORTE PARA MOTOR DERECHO	1777
		SOPORTE PARA TRANSMISIÓN	1856
V6 2.8	84-86	SOPORTE PARA TRANSMISIÓN	1577
		SOPORTE PARA MOTOR IZQUIERDO Y DERECHO	7228
		SOPORTE PARA TRANSMISIÓN	6800
V8 5.9	72-83	SOPORTE PARA TRANSMISIÓN	1577
V8 5.0	72-83	SOPORTE PARA MOTOR IZQUIERDO Y DERECHO	6773



WILLYS

			APLICACIÓN / DESCRIPTION	DAI PARTS #
SOPORTES / TRANSMISSION & MOTOR MOUNTS				
L4 150	46-62		SOPORTE PARA TRANSMISIÓN STD.	1663
L6 4.2 L6 4.6	77-85		SOPORTE PARA MOTOR IZQUIERDO	1710
			SOPORTE PARA MOTOR IZQUIERDO	1711
			SOPORTE PARA MOTOR DERECHO	1777
			SOPORTE PARA TRANSMISIÓN	1856



WRANGLER

SOPORTES / TRANSMISSION & MOTOR MOUNTS				
L4 1.6	93-97		SOPORTE PARA TRANSMISIÓN TRASERO	6971
L4 2.4	97-06		SOPORTE PARA MOTOR IZQUIERDO Y DERECHO	7228



MISCELÁNEOS / AUTOMOTIVE RUBBER PARTS				
	07-11		BUJE PARA HORQUILLA SUPERIOR	DAI-1406036



KIA

AMANTI

		APLICACIÓN / DESCRIPTION	DAI PARTS #
SOPORTES / TRANSMISSION & MOTOR MOUNTS			
V6 3.8	07-09	SOPORTE PARA MOTOR FRONTAL	7490



RIO

SOPORTES / TRANSMISSION & MOTOR MOUNTS			
L4 1.6	06-11	SOPORTE PARA MOTOR DERECHO	7616-H
		SOPORTE PARA TRANSMISIÓN	7639



	APLICACIÓN / DESCRIPTION	DAI PARTS #	DAI KIT PARTS #
BASES PARA AMORTIGUADOR / STRUT MOUNTS			
07-11	BASE PARA AMORTIGUADOR FRONTAL IZQUIERDA Y DERECHA	7344	



RIO 5

	28	APLICACIÓN / DESCRIPTION	DAI PARTS #
SOPORTES / TRANSMISSION & MOTOR MOUNTS			
L4 1.6	06-11	SOPORTE PARA TRANSMISIÓN	7639



LEXUS

ES-300

		APLICACIÓN / DESCRIPTION	DAI PARTS #
SOPORTES / TRANSMISSION & MOTOR MOUNTS			
V6 3.0	92-96	REPUESTO PARA SOPORTE DE MOTOR TRASERO	7745-9
	97-01	SOPORTE PAR AMOTOR DERECHO SUPERIOR TORQUE STRUT	7757
		REPUESTO PARA SOPORTE DE MOTOR TRASERO	7782-9
	02-03	SOPORTE PARA TRANSMISIÓN	7257-H
		REPUESTO PARA SOPORTE DE TORSIÓN	7440-9
		SOPORTE PARA MOTOR DERECHO SUPERIOR TORSIÓN	7660
V6 3.3	04-06	REPUESTO PARA SOPORTE DE TORSIÓN	7440-9
	04-09	SOPORTE PARA TRANSMISIÓN	7257-H



ES-350

SOPORTES / TRANSMISSION & MOTOR MOUNTS			
V6 3.5	07-12	SOPORTE PARA MOTOR FRONTAL DERECHO	7701
	07-16	SOPORTE PARA TRANSMISIÓN FRONTAL INFERIOR	7708



CONTINUACIÓN... ES-350

	 28	APLICACIÓN / DESCRIPTION	DAI PARTS #
SOPORTES / TRANSMISSION & MOTOR MOUNTS			
V6 3.5	07-16	SOPORTE PARA TRANSMISIÓN FRONTAL INFERIOR	7708-H

RX-300

SOPORTES / TRANSMISSION & MOTOR MOUNTS			
V6 3.3	99-03	SOPORTE PARA MOTOR DERECHO SUPERIOR TORSIÓN	7660

RX-330

SOPORTES / TRANSMISSION & MOTOR MOUNTS			
V6 3.3	04-07	SOPORTE PARA TRANSMISIÓN	7257-H
	04-08	REPUESTO PARA SOPORTE DE TORSIÓN	7440-9



RX-350

  28		APLICACIÓN / DESCRIPTION	DAI PARTS #
SOPORTES / TRANSMISSION & MOTOR MOUNTS			
V6 3.5	10-15	SOPORTE PARA MOTOR DERECHO	7701
		SOPORTE PARA TRANSMISIÓN FRONTAL INFERIOR	7708
		SOPORTE PARA TRANSMISIÓN FRONTAL INFERIOR	7708-H



RX-400H

SOPORTES / TRANSMISSION & MOTOR MOUNTS			
V6 3.3	04-07	SOPORTE PARA TRANSMISIÓN	7257-H



RX-450H

SOPORTES / TRANSMISSION & MOTOR MOUNTS			
V6 3.5	10-15	SOPORTE PARA MOTOR FRONTAL DERECHO	7701



LINCOLN

AVIATOR

 28	APLICACIÓN / DESCRIPTION	DAI PARTS #
MISCELÁNEOS / AUTOMOTIVE RUBBER PARTS		
02-05	GOMA PARA BARRA ESTABILIZADOR 1"	64716



CONTINENTAL

28	APLICACIÓN / DESCRIPTION	DAI PARTS #	DAI KIT PARTS #
BASES PARA AMORTIGUADOR / STRUT MOUNTS			
82-94	BASE PARA AMORTIGUADOR FRONTAL IZQUIERDA Y DERECHA	6730	6730-KIT



 28	APLICACIÓN / DESCRIPTION	DAI PARTS #
MISCELÁNEOS / AUTOMOTIVE RUBBER PARTS		
95-02	TORNILLO ESTABILIZADOR FRONTAL IZQUIERDO	DAI-K-8734
	BUJE PARA HORQUILLA INFERIOR	DAI-K-8452-A
88-94	TORNILLO ESTABILIZADOR FRONTAL	DAI-K-8702



LS

28		APLICACIÓN / DESCRIPTION	DAI PARTS #
SOPORTES / TRANSMISSION & MOTOR MOUNTS			
V6 3.0	00-05	SOPORTE PARA MOTOR IZQUIERDO Y DERECHO	7566-H
V8 3.8	00-06		

MARK

SOPORTES / TRANSMISSION & MOTOR MOUNTS			
V8 5.4	06-08	SOPORTE PARA MOTOR IZQUIERDO	7580-H
		SOPORTE PARA MOTOR DERECHO	7601-H

MARK LT

SOPORTES / TRANSMISSION & MOTOR MOUNTS			
V8 5.4	06-11	SOPORTE PARA MOTOR IZQUIERDO	7382-H
		SOPORTE PARA MOTOR DERECHO	7383-H



CONTINUACIÓN... MARK LT

28	APLICACIÓN / DESCRIPTION	DAI PARTS #	DAI KIT PARTS #
BASES PARA AMORTIGUADOR / STRUT MOUNTS			
06-08	BASE PARA AMORTIGUADOR FRONTAL IZQUIERDA Y DERECHA (4X2 Y 4X4)		7366-KIT

BASES PARA AMORTIGUADOR STRUT MOUNTS



7366-KIT

28	APLICACIÓN / DESCRIPTION	DAI PARTS #
MISCELÁNEOS / AUTOMOTIVE RUBBER PARTS		
06-08	BUJES PARA HORQUILLA SUPERIOR (4X2 Y 4X4)	DAI-1408040

MISCELÁNEOS AUTOMOTIVE RUBBER PARTS



DAI-1408040

MKS

SOPORTES / TRANSMISSION & MOTOR MOUNTS			
V6 3.5	10-15	SOPORTE PARA MOTOR TRASERO TORQUE STRUT	7739
		SOPORTE PARA MOTOR FRONTAL TORQUE STRUT	7740

SOPORTES TRANSMISSION & MOTOR MOUNTS



7739



7740

MKT

SOPORTES / TRANSMISSION & MOTOR MOUNTS			
V6 3.5	10-16	SOPORTE PARA MOTOR TRASERO TORQUE STRUT	7739
		SOPORTE PARA MOTOR FRONTAL TORQUE STRUT	7740

SOPORTES TRANSMISSION & MOTOR MOUNTS



7739



7740



MKX

 28	APLICACIÓN / DESCRIPTION	DAI PARTS #	
SOPORTES / TRANSMISSION & MOTOR MOUNTS			
V6 3.5	06-12	SOPORTE PARA MOTOR TRASERO	7558

MKZ



SOPORTES / TRANSMISSION & MOTOR MOUNTS			
L4 2.0	13-17	SOPORTE PARA TRANSMISIÓN	7766
V6 3.5	06-11	SOPORTE PARA MOTOR TRASERO	7249
		SOPORTE PARA MOTOR DERECHO	7250-H
		SOPORTE PARA MOTOR DERECHO	7255-H
		SOPORTE PARA TRANSMISIÓN	7276-H
	07-12	REPUESTO PARA SOPORTE DE TRANSMISIÓN (SOLIDO)	7651-9
08-12	SOPORTE PARA TRANSMISIÓN	7651-H	



 28	APLICACIÓN / DESCRIPTION	DAI PARTS #	DAI KIT PARTS #
BASES PARA AMORTIGUADOR / STRUT MOUNTS			
10-12	BASE PARA AMORTIGUADOR FRONTAL IZQUIERDA Y DERECHA	7597	



CONTINUACIÓN... MKZ

	 28	APLICACIÓN / DESCRIPTION	DAI PARTS #
MISCELÁNEOS / AUTOMOTIVE RUBBER PARTS			
	06-11	TORNILLO ESTABILIZADOR TRASERO	DAI-2113005
	06-12	BUJE PARA HORQUILLA INFERIOR (CURVA)	DAI-1408066
		BUJE PARA HORQUILLA INFERIOR (INTERIOR AL AMORTIGUADOR)	DAI-1408067
	09-14	BUJE PARA HORQUILLA TRASERA SUPERIOR (2 PIEZAS)	DAI-1508086

**MISCELÁNEOS
AUTOMOTIVE RUBBER PARTS**



DAI-2113005



DAI-1408066



DAI-1408067



DAI-1508086

NUEVO

NAVIGATOR

SOPORTES / TRANSMISSION & MOTOR MOUNTS			
V8 5.4	98-03	SOPORTE PARA MOTOR DERECHO (EQUIVALENTE AL 7110)	7106
		SOPORTE PARA MOTOR DERECHO	7107
		SOPORTE PARA MOTOR DERECHO	7110
		SOPORTE PARA TRANSMISIÓN	7173
		REPUESTO PARA SOPORTE DE MOTOR IZQUIERDO Y DERECHO	7599-9

SOPORTES TRANSMISSION & MOTOR MOUNTS



7106



7107



7110



7173



7599-9

NUEVO



CONTINUACIÓN... NAVIGATOR

		APLICACIÓN / DESCRIPTION	DAI PARTS #
MISCELÁNEOS / AUTOMOTIVE RUBBER PARTS			
	80-96	GOMA PARA TIRANTE DE SUSPENSIÓN	64350
V8 4.6	97-02	GOMA PARA BARRA ESTABILIZADORA FRONTAL Y TRASERA	6433
		GOMA PARA BARRA ESTABILIZADORA (DELANTERA)	6434
	03-06	BUJES PARA HORQUILLA SUPERIOR (4X2 Y 4X4)	DAI-1408040

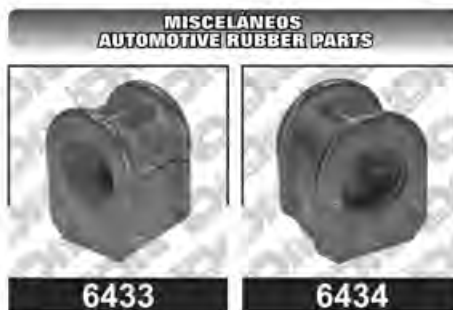
TOWN CAR

SOPORTES / TRANSMISSION & MOTOR MOUNTS			
V8 4.6	91-97	SOPORTE PARA TRANSMISIÓN	6622
		SOPORTE PARA MOTOR DERECHO	6701
		SOPORTE PARA MOTOR IZQUIERDO	6702



MISCELÁNEOS / AUTOMOTIVE RUBBER PARTS			
	83-86	TORNILLO ESTABILIZADOR (10", 254.0 mm)	6103
		TORNILLO ESTABILIZADOR (10", 243 mm EQUIPO ORIGINAL)	6107



CONTINUACIÓN... TOWN CAR

		APLICACIÓN / DESCRIPTION	DAI PARTS #
MISCELÁNEOS / AUTOMOTIVE RUBBER PARTS			
	95-02	TORNILLO ESTABILIZADOR FRONTAL	DAI-K-8953

**MISCELÁNEOS
AUTOMOTIVE RUBBER PARTS**



DAI-K-8953

ZEPHYR

SOPORTES / TRANSMISSION & MOTOR MOUNTS			
L4 2.0	13-17	SOPORTE PARA TRANSMISIÓN	7766
V6 3.0	2006	SOPORTE PARA MOTOR DERECHO	7250-H
	06-12	REPUESTO PARA SOPORTE DE TRANSMISIÓN (SÓLIDO)	7651-9
	08-12	SOPORTE PARA TRANSMISIÓN	7651-H
V6 3.5	06-11	SOPORTE PARA MOTOR TRASERO	7249
		SOPORTE PARA MOTOR DERECHO	7250-H
		SOPORTE PARA MOTOR DERECHO	7255-H
		SOPORTE PARA TRANSMISIÓN	7276-H
	06-12	REPUESTO PARA SOPORTE DE TRANSMISIÓN (SÓLIDO)	7651-9
	08-12	SOPORTE PARA TRANSMISIÓN	7651-H

SOPORTES TRANSMISSION & MOTOR MOUNTS



7249



7250-H



7255-H



7276-H



7651-H



7651-9



7766



CONTINUACIÓN... ZEPHYR

28	APLICACIÓN / DESCRIPTION	DAI PARTS #	DAI KIT PARTS #
BASES PARA AMORTIGUADOR / STRUT MOUNTS			
78-83	REPUESTO BASE DE AMORTIGUADOR FRONTAL IZQUIERDA Y DERECHA		6729-KIT
2012	BASE PARA AMORTIGUADOR FRONTAL IZQUIERDA Y DERECHA	7597	



28	APLICACIÓN / DESCRIPTION	DAI PARTS #
MISCELÁNEOS / AUTOMOTIVE RUBBER PARTS		
06-12	TORNILLO ESTABILIZADOR TRASERO	DAI-2113005
	BUJE PARA HORQUILLA INFERIOR (CURVA)	DAI-1408066
	BUJE PARA HORQUILLA INFERIOR (INTERIOR AL AMORTIGUADOR)	DAI-1408067



MAZDA

2

 		APLICACIÓN / DESCRIPTION	DAI PARTS #
SOPORTES / TRANSMISSION & MOTOR MOUNTS			
L4 1.5	11-16	SOPORTE PARA MOTOR TRASERO TORQUE STRUT TRANSMISIÓN AUT.	7730
		SOPORTE PARA TRANSMISIÓN AUT.	7731



3

SOPORTES / TRANSMISSION & MOTOR MOUNTS			
L4 2.0	04-13	COMPLEMENTO PARA SOPORTE DE MOTOR TRASERO	7768
	06-11	SOPORTE PARA MOTOR TRASERO	7152
		SOPORTE PARA TRANSMISIÓN AUT.	7153
		SOPORTE PARA TRANSMISIÓN STD. R/T	7154
		SOPORTE PARA TRANSMISIÓN STD.	7155
	06-11	SOPORTE PARA MOTOR DERECHO	7151-H
	14-16		
13-17	SOPORTE PARA MOTOR TRASERO AUTOMATICO TORQUE STRUT	7774	
14-16	SOPORTE PARA MOTOR DERECHO	7737-H	
L4 2.3	04-09	SOPORTE PARA TRANSMISIÓN	7537
	04-09	COMPLEMENTO PARA SOPORTE DE MOTOR TRASERO	7768
	2013		





CONTINUACIÓN... 3

 		APLICACIÓN / DESCRIPTION	DAI PARTS #
SOPORTES / TRANSMISSION & MOTOR MOUNTS			
L4 2.3	06-11	SOPORTE PARA MOTOR DERECHO	7151-H
		SOPORTE PARA MOTOR TRASERO	7152
		SOPORTE PARA TRANSMISIÓN AUT.	7153
		SOPORTE PARA TRANSMISIÓN STD. R/T	7154
		SOPORTE PARA TRANSMISIÓN STD.	7155
L4 2.5	10-13	COMPLEMENTO PARA SOPORTE DE MOTOR TRASERO	7768



 		APLICACIÓN / DESCRIPTION	DAI PARTS #	DAI KIT PARTS #
BASES PARA AMORTIGUADOR / STRUT MOUNTS				
03-09		BASE PARA AMORTIGUADOR TRASERA IZQUIERDA Y DERECHA	7156	
03-14		BASE PARA AMORTIGUADOR FRONTAL IZQUIERDA Y DERECHA	7182	



 		APLICACIÓN / DESCRIPTION	DAI PARTS #
MISCELÁNEOS / AUTOMOTIVE RUBBER PARTS			
	03-09	TORNILLO ESTABILIZADOR FRONTAL	DAI-2113001
		BUJE PARA HORQUILLA INFERIOR GRANDE	DAI-1408057





 		APLICACIÓN / DESCRIPTION	DAI PARTS #
SOPORTES / TRANSMISSION & MOTOR MOUNTS			
L4 2.3	06-10	SOPORTE PARA MOTOR DERECHO	7151-H
		SOPORTE PARA MOTOR TRASERO	7152
		SOPORTE PARA TRANSMISIÓN STD.	7537
L4 2.3	08-10	COMPLEMENTO PARA SOPORTE DE MOTOR TRASERO	7768
L4 2.5	12-14		



		APLICACIÓN / DESCRIPTION	DAI PARTS #	DAI KIT PARTS #
BASES PARA AMORTIGUADOR / STRUT MOUNTS				
03-11		BASE PARA AMORTIGUADOR TRASERA IZQUIERDA Y DERECHA	7156	



 		APLICACIÓN / DESCRIPTION	DAI PARTS #
MISCELÁNEOS / AUTOMOTIVE RUBBER PARTS			
	03-11	TORNILLO ESTABILIZADOR FRONTAL	DAI-2113001
	03-14	BUJE PARA HORQUILLA INFERIOR GRANDE	DAI-1408057



  28		APLICACIÓN / DESCRIPTION	DAI PARTS #
SOPORTES / TRANSMISSION & MOTOR MOUNTS			
L4 2.3	03-08	SOPORTE PARA MOTOR TRASERO	7436
		SOPORTE PARA MOTOR DERECHO	7777-H
	06-11	SOPORTE PARA MOTOR TRASERO	7249
		SOPORTE PARA TRANSMISIÓN	7276-H
		SOPORTE PARA TRANSMISIÓN	7661
L4 2.5	06-11	SOPORTE PARA MOTOR DERECHO	7255-H
	13-17	SOPORTE PARA MOTOR TRASERO AUTOMATICO TORQUE STRUT	7774
V6 3.0	03-08	SOPORTE PARA MOTOR DERECHO	7777-H
	06-11	SOPORTE PARA MOTOR TRASERO	7249
		SOPORTE PARA TRANSMISIÓN	7276-H
V6 3.7	09-13	SOPORTE PARA TRANSMISIÓN	7651-H
		REPUESTO PARA SOPORTE DE TRANSMISIÓN (SOLIDO)	7651-9

SOPORTES TRANSMISSION & MOTOR MOUNTS

7249

7255-H

7276-H

7436

7651-H

7651-9

7661

7774

7777-H

 28		APLICACIÓN / DESCRIPTION	DAI PARTS #	DAI KIT PARTS #
BASES PARA AMORTIGUADOR / STRUT MOUNTS				
02-08	BASE PARA AMORTIGUADOR FRONTAL IZQUIERDA Y DERECHA		7597	

BASES PARA AMORTIGUADOR STRUT MOUNTS

7597



CONTINUACIÓN... 6

		APLICACIÓN / DESCRIPTION	DAI PARTS #
MISCELÁNEOS / AUTOMOTIVE RUBBER PARTS			
02-08		TORNILLO ESTABILIZADOR TRASERO	DAI-2113005
		BUJE PARA HORQUILLA INFERIOR (CURVA)	DAI-1408066
		BUJE PARA HORQUILLA INFERIOR (INTERIOR AL AMORTIGUADOR)	DAI-1408067
02-12		TORNILLO ESTABILIZADOR FRONTAL DERECHO	DAI-2113004

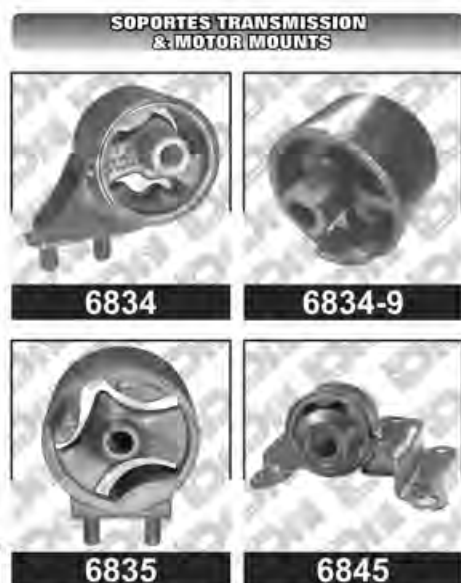

323

SOPORTES / TRANSMISSION & MOTOR MOUNTS			
L4 1.5	83-85	SOPORTE PARA MOTOR FRONTAL	6961
L4 1.8	90-91	SOPORTE PARA TRANSMISIÓN TRASERO AUT.	6834
		REPUESTO PARA SOPORTE DE TRANSMISIÓN TRASERO (6834 Y 6973)	6834-9
		SOPORTE PARA MOTOR FRONTAL	6835
		SOPORTE PARA MOTOR TRASERO STD.	6845
		REPUESTO PARA SOPORTE DE TRANSMISIÓN TRASERO (6845)	6845-9
		SOPORTE PARA MOTOR DERECHO	6850
L4 2.2	88-92	SOPORTE PARA TRANSMISIÓN	6861



626

 		APLICACIÓN / DESCRIPTION	DAI PARTS #
SOPORTES / TRANSMISSION & MOTOR MOUNTS			
L4 2.2	88-92	SOPORTE PARA TRANSMISIÓN	6861
L4 2.5	93-97	SOPORTE PARA MOTOR TRASERO	6965
		SOPORTE PARA MOTOR TRASERO	6966
		SOPORTE PARA MOTOR FRONTAL	6967
		SOPORTE PARA MOTOR FRONTAL	6969

B 2000 Y B 2200

SOPORTES / TRANSMISSION & MOTOR MOUNTS			
L4 2.0	81-87	SOPORTE PARA MOTOR IZQUIERDO Y DERECHO	6858



MISCELÁNEOS / AUTOMOTIVE RUBBER PARTS			
		GOMA PARA BARRA ESTABILIZADORA (POLIURETANO)	9171
		GOMA PARA BARRA ESTABILIZADORA (POLIURETANO) B2200	9144



B 3000 Y B 4000

				APLICACIÓN / DESCRIPTION	DAI PARTS #
SOPORTES / TRANSMISSION & MOTOR MOUNTS					
V6 3.0	94-97	SOPORTE PARA MOTOR IZQUIERDO (4X4)			6948
		SOPORTE PARA MOTOR IZQUIERDO Y DERECHO			7779
V6 4.0	94-97	SOPORTE PARA MOTOR IZQUIERDO (4X4)			6948
		SOPORTE PARA MOTOR IZQUIERDO Y DERECHO			7779



CX-5

SOPORTES / TRANSMISSION & MOTOR MOUNTS					
L4 2.0	13-16	SOPORTE PARA MOTOR DERECHO			7737-H
		SOPORTE PARA MOTOR TRASERO AUT. TORQUE STRUT			7774
L4 2.5	13-16	SOPORTE PARA MOTOR DERECHO			7774



CX-7

SOPORTES / TRANSMISSION & MOTOR MOUNTS					
L4 2.3	07-12	REPUESTO PARA SOPORTE DE MOTOR TRASERO			7504
		SOPORTE PARA TRANSMISIÓN			7741



CONTINUACIÓN... CX-7

 		APLICACIÓN / DESCRIPTION	DAI PARTS #
SOPORTES / TRANSMISSION & MOTOR MOUNTS			
L4 2.3	07-12	SOPORTE PARA MOTOR DERECHO	7554-H
L4 2.5			

**SOPORTES
TRANSMISSION & MOTOR MOUNTS**

7554-H
CX-9

SOPORTES / TRANSMISSION & MOTOR MOUNTS			
V6 3.5	07-08	REPUESTO PARA SOPORTE DE MOTOR TRASERO	7504
	2007	SOPORTE PARA TRANSMISIÓN	7741
V6 3.7	08-13	REPUESTO PARA SOPORTE DE MOTOR TRASERO	7504
	08-15	SOPORTE PARA TRANSMISIÓN	7741

**SOPORTES TRANSMISSION
& MOTOR MOUNTS**

7504

7741
GLS

SOPORTES / TRANSMISSION & MOTOR MOUNTS			
L4 2.2	88-92	SOPORTE PARA TRANSMISIÓN	6861

**SOPORTES TRANSMISSION
& MOTOR MOUNTS**

6861

MPV MINI VAN

 	28	APLICACIÓN / DESCRIPTION	DAI PARTS #
MISCELÁNEOS / AUTOMOTIVE RUBBER PARTS			
	00-03	TORNILLO ESTABILIZADOR (4X2)	DAI-2106016

**MISCELÁNEOS
AUTOMOTIVE RUBBER PARTS**



DAI-2106016

MX-3

SOPORTES / TRANSMISSION & MOTOR MOUNTS			
L4 1.6	92-96	REPUESTO PARA SOPORTE DE TRANSMISIÓN TRASERO (92-96 STD., 92-93 AUT.)	6834
		REPUESTO PARA SOPORTE DE TRANSMISIÓN TRASERO (6834 Y 6973)	6834-9
		SOPORTE PARA MOTOR FRONTAL (1992 STD., 92-93 AUT.)	6835
		SOPORTE PARA TRANSMISIÓN	6845-9
	94-96	SOPORTE PARA TRANSMISIÓN TRASERO AUT.	6845

SOPORTES TRANSMISSION & MOTOR MOUNTS



6834



6834-9



6835



6845



6845-9



NAVAJO

		APLICACIÓN / DESCRIPTION	DAI PARTS #
SOPORTES / TRANSMISSION & MOTOR MOUNTS			
V6 4.0	91-94	SOPORTE PARA TRANSMISIÓN	6890
		SOPORTE PARA MOTOR DERECHO	6891
		SOPORTE PARA MOTOR IZQUIERDO	6892
		SOPORTE PARA TRANSMISIÓN	6924
		SOPORTE PARA MOTOR IZQUIERDO Y DERECHO	6948



MISCELÁNEOS / AUTOMOTIVE RUBBER PARTS		
91-94	GOMA PARA TIRANTE DE SUSPENSIÓN (4X2)	64350



PICK UP

 		APLICACIÓN / DESCRIPTION	DAI PARTS #
MISCELÁNEOS / AUTOMOTIVE RUBBER PARTS			
		COPLÉ PARA DIRECCIÓN (SINFÍN DE .650 " 2 PERNOS GRUESOS)	619
		GALLETAS PARA DIRECCIÓN STD. Y HID. (2 PERNOS GRUESOS CON BUJES COMPLETO 619 Y 630)	641
94-97		GOMA PARA TIRANTE DE SUSPENSIÓN (4X4 Y 4X2)	64350



PROTEGE

SOPORTES / TRANSMISSION & MOTOR MOUNTS			
		SOPORTE PARA TRANSMISIÓN	6834
		REPUESTO PARA SOPORTE DE TRANSMISIÓN (6834)	6834-9
		SOPORTE PARA MOTOR FRONTAL	6835
L4 1.8	90-94	SOPORTE PARA MOTOR FRONTAL (6835)	6835-9
		SOPORTE PARA MOTOR TRASERO	6845
		REPUESTO PARA SOPORTE DE TRANSMISIÓN TRASERO (6845)	6845-9
		SOPORTE PARA MOTOR DERECHO	6850





TRIBUTE

 		APLICACIÓN / DESCRIPTION	DAI PARTS #
SOPORTES / TRANSMISSION & MOTOR MOUNTS			
L4 2.3	01-05	SOPORTE PARA MOTOR TRASERO	7117
		SOPORTE PARA TRANSMISIÓN STD.	7118
		SOPORTE PARA MOTOR DERECHO	7237-H
V6 3.0	01-05	SOPORTE PARA MOTOR TRASERO	7117
		SOPORTE PARA TRANSMISIÓN STD.	7118
		SOPORTE PARA MOTOR DERECHO	7237-H



 		APLICACIÓN / DESCRIPTION	DAI PARTS #	DAI KIT PARTS #
BASES PARA AMORTIGUADOR / STRUT MOUNTS				
01-12		BASE PARA AMORTIGUADOR FRONTAL IZQUIERDA Y DERECHA		7299-KIT



 		APLICACIÓN / DESCRIPTION	DAI PARTS #
MISCELÁNEOS / AUTOMOTIVE RUBBER PARTS			
	01-12	TORNILLO ESTABILIZADOR FRONTAL	DAI-2108004
		BUJE PARA HORQUILLA INFERIOR GRANDE	DAI-1408007



CONTINUACIÓN... TRIBUTE

	 28	APLICACIÓN / DESCRIPTION	DAI PARTS #
MISCELÁNEOS / AUTOMOTIVE RUBBER PARTS			
	01-12	BUJE PARA HORQUILLA INFERIOR CHICO	DAI-1408063
		TORNILLO ESTABILIZADOR FRONTAL (LARGO)	DAI-2108002



VARIOS

MISCELÁNEOS / AUTOMOTIVE RUBBER PARTS			
		GALLETAS PARA DIRECCIÓN STD. Y HID. (2 PERNOS DELGADOS CON BUJES COMPLETO 618)	640



MERCEDES BENZ

190-D

 		APLICACIÓN / DESCRIPTION	DAI PARTS #
SOPORTES / TRANSMISSION & MOTOR MOUNTS			
L5 2.5	86-89	SOPORTE PARA MOTOR IZQUIERDO Y DERECHO	7336-H



190-E

SOPORTES / TRANSMISSION & MOTOR MOUNTS			
L4 2.3	84-93	SOPORTE PARA MOTOR IZQUIERDO Y DERECHO	7336-H
L6 2.6	87-93		



300-CE

SOPORTES / TRANSMISSION & MOTOR MOUNTS			
L6 3.0	88-89	SOPORTE PARA MOTOR IZQUIERDO Y DERECHO	7336-H
L6 3.2	1993		



300-E

SOPORTES / TRANSMISSION & MOTOR MOUNTS			
L6 3.2	1993	SOPORTE PARA MOTOR IZQUIERDO Y DERECHO	7336-H



300-TD

28
APLICACIÓN / DESCRIPTION
**DAI
PARTS #**
**SOPORTES
TRANSMISSION & MOTOR MOUNTS**
SOPORTES / TRANSMISSION & MOTOR MOUNTS

L6 3.0

87-89

SOPORTE PARA MOTOR
IZQUIERDO Y DERECHO

7336-H

7336-H
300-TE
SOPORTES / TRANSMISSION & MOTOR MOUNTS

L6 3.0

87-89

SOPORTE PARA MOTOR
IZQUIERDO Y DERECHO

7336-H

**SOPORTES TRANSMISSION
& MOTOR MOUNTS**

7336-H
A-140
SOPORTES / TRANSMISSION & MOTOR MOUNTS

L4 1.4

97-04

SOPORTE PARA MOTOR TRASERO

7454

L4 1.4

97-04

SOPORTE PARA MOTOR FRONTAL

7512

L4 1.6

00-04

**SOPORTES TRANSMISSION
& MOTOR MOUNTS**

7454

7512
A-160
SOPORTES / TRANSMISSION & MOTOR MOUNTS

L4 1.6

97-06

SOPORTE PARA MOTOR TRASERO

7454

97-04

SOPORTE PARA MOTOR FRONTAL

7512

**SOPORTES
TRANSMISSION & MOTOR MOUNTS**

7454

7512

A-190

			APLICACIÓN / DESCRIPTION	DAI PARTS #
SOPORTES / TRANSMISSION & MOTOR MOUNTS				
L4 1.9	99-05		SOPORTE PARA MOTOR TRASERO	7454
	99-04		SOPORTE PARA MOTOR FRONTAL	7512



A-210

		SOPORTES / TRANSMISSION & MOTOR MOUNTS	
L4 2.1	02-04	SOPORTE PARA MOTOR TRASERO	7454
		SOPORTE PARA MOTOR FRONTAL	7512



C-32 AMG

		SOPORTES / TRANSMISSION & MOTOR MOUNTS	
V6 3.2	02-04	SOPORTE PARA TRANSMISIÓN AUT.	7466



C-36 AMG

		SOPORTES / TRANSMISSION & MOTOR MOUNTS	
V6 3.6	94-00	SOPORTE PARA TRANSMISIÓN	7589
V6 3.7		SOPORTE PARA TRANSMISIÓN	7622



C-43 AMG

 		APLICACIÓN / DESCRIPTION	DAI PARTS #
SOPORTES / TRANSMISSION & MOTOR MOUNTS			
V8 4.3	98-00	SOPORTE PARA TRANSMISIÓN AUT.	7466
		SOPORTE PARA MOTOR IZQUIERO	7630-H

C-55 AMG

SOPORTES / TRANSMISSION & MOTOR MOUNTS			
V8 5.5	05-06	SOPORTE PARA TRANSMISIÓN AUT.	7466

C-180

SOPORTES / TRANSMISSION & MOTOR MOUNTS			
L4 1.8	93-00	SOPORTE PARA TRANSMISIÓN	7589
		SOPORTE PARA TRANSMISIÓN	7622

C-200

SOPORTES / TRANSMISSION & MOTOR MOUNTS			
L4 2.0	93-00	SOPORTE PARA TRANSMISIÓN (DIESEL)	7589
	94-01	SOPORTE PARA TRANSMISIÓN	
	93-00	SOPORTE PARA TRANSMISIÓN (DIESEL)	7622
	94-00	SOPORTE PARA TRANSMISIÓN	
	95-00	SOPORTE PARA TRANSMISIÓN (KOMPRESSOR)	



CONTINUACIÓN... C-200

28	APLICACIÓN / DESCRIPTION	DAI PARTS #	DAI KIT PARTS #
BASES PARA AMORTIGUADOR / STRUT MOUNTS			
07-14	BASE PARA AMORTIGUADOR FRONTAL IZQUIERDA Y DERECHA	7465	



C-220

28	APLICACIÓN / DESCRIPTION	DAI PARTS #	
SOPORTES / TRANSMISSION & MOTOR MOUNTS			
L4 2.2	93-00	SOPORTE PARA TRANSMISIÓN (DIESEL)	7589
		SOPORTE PARA TRANSMISIÓN	
		SOPORTE PARA TRANSMISIÓN (DIESEL)	7622
		SOPORTE PARA TRANSMISIÓN	



28	APLICACIÓN / DESCRIPTION	DAI PARTS #	DAI KIT PARTS #
BASES PARA AMORTIGUADOR / STRUT MOUNTS			
07-14	BASE PARA AMORTIGUADOR FRONTAL IZQUIERDA Y DERECHA	7465	



C-230

28	APLICACIÓN / DESCRIPTION	DAI PARTS #	
SOPORTES / TRANSMISSION & MOTOR MOUNTS			
L4 1.8	03-05	SOPORTE PARA TRANSMISIÓN AUT. 7466	
L4 2.3	99-00		
L4 2.3	96-98	SOPORTE PARA TRANSMISIÓN	7589
	97-00	SOPORTE PARA TRANSMISIÓN (DIESEL)	



CONTINUACIÓN... C-230

		APLICACIÓN / DESCRIPTION	DAI PARTS #
SOPORTES / TRANSMISSION & MOTOR MOUNTS			
L4 2.3	95-00	SOPORTE PARA TRANSMISIÓN (KOMPRESSOR)	7622
L4 2.5	07-14	SOPORTE PARA MOTOR IZQUIERDO Y DERECHO	7511-H
V6 2.5	06-07	SOPORTE PARA MOTOR IZQUIERDO	7630-H



		APLICACIÓN / DESCRIPTION	DAI PARTS #	DAI KIT PARTS #
BASES PARA AMORTIGUADOR / STRUT MOUNTS				
08-13		BASE PARA AMORTIGUADOR TRASERA IZQUIERDA Y DERECHA	7624	
07-14		BASE PARA AMORTIGUADOR FRONTAL IZQUIERDA Y DERECHA	7465	

C-240

		APLICACIÓN / DESCRIPTION	DAI PARTS #
SOPORTES / TRANSMISSION & MOTOR MOUNTS			
V6 2.6	01-05	SOPORTE PARA TRANSMISIÓN AUT.	7466



C-250

		APLICACIÓN / DESCRIPTION	DAI PARTS #
SOPORTES / TRANSMISSION & MOTOR MOUNTS			
L4 2.5	07-14	SOPORTE PARA MOTOR IZQUIERDO Y DERECHO	7511-H
L5 2.5	93-01	SOPORTE PARA TRANSMISIÓN (DIESEL)	7589
	93-00	SOPORTE PARA TRANSMISIÓN (DIESEL)	7622



7622



	APLICACIÓN / DESCRIPTION	DAI PARTS #	DAI KIT PARTS #
BASES PARA AMORTIGUADOR / STRUT MOUNTS			
12-14	BASE PARA AMORTIGUADOR TRASERA IZQUIERDA Y DERECHA	7624	



C-280

		APLICACIÓN / DESCRIPTION	DAI PARTS #
SOPORTES / TRANSMISSION & MOTOR MOUNTS			
V6 2.8	98-00	SOPORTE PARA TRANSMISIÓN AUT.	7466
V6 3.0	06-07		
V6 2.8	93-00	SOPORTE PARA TRANSMISIÓN	7589



CONTINUACIÓN... C-280

 		APLICACIÓN / DESCRIPTION	DAI PARTS #
SOPORTES / TRANSMISSION & MOTOR MOUNTS			
V6 2.8	93-00	SOPORTE PARA TRANSMISIÓN	7622
V6 3.0	07-14	SOPORTE PARA MOTOR IZQUIERDO Y DERECHO	7511-H
	06-07	SOPORTE PARA MOTOR IZQUIERDO	7630-H



		APLICACIÓN / DESCRIPTION	DAI PARTS #	DAI KIT PARTS #
BASES PARA AMORTIGUADOR / STRUT MOUNTS				
07-14	BASE PARA AMORTIGUADOR FRONTAL IZQUIERDA Y DERECHA		7465	

C-300

BASES PARA AMORTIGUADOR / STRUT MOUNTS				
08-14	BASE PARA AMORTIGUADOR TRASERA IZQUIERDA Y DERECHA		7624	
09-14	BASE PARA AMORTIGUADOR FRONTAL IZQUIERDA Y DERECHA		7465	



C-320

		APLICACIÓN / DESCRIPTION	DAI PARTS #
SOPORTES / TRANSMISSION & MOTOR MOUNTS			
L6 3.2	03-05	SOPORTE PARA MOTOR IZQUIERDO	7630-H
V6 3.2	01-05	SOPORTE PARA TRANSMISIÓN AUT.	7466



C-350

SOPORTES / TRANSMISSION & MOTOR MOUNTS			
V6 3.5	06-08	SOPORTE PARA MOTOR IZQUIERDO	7630-H
	07-14	SOPORTE PARA MOTOR IZQUIERDO Y DERECHO	7511-H



		APLICACIÓN / DESCRIPTION	DAI PARTS #	DAI KIT PARTS #
BASES PARA AMORTIGUADOR / STRUT MOUNTS				
07-14		BASE PARA AMORTIGUADOR FRONTAL IZQUIERDA Y DERECHA	7465	
08-14		BASE PARA AMORTIGUADOR TRASERA IZQUIERDA Y DERECHA	7624	





CL-55

		APLICACIÓN / DESCRIPTION	DAI PARTS #
SOPORTES / TRANSMISSION & MOTOR MOUNTS			
V8 5.5	03-06	SOPORTE PARA MOTOR IZQUIERDO	7630-H
	2006	SOPORTE PARA MOTOR IZQUIERDO (AMG)	



CL-63

  28		APLICACIÓN / DESCRIPTION	DAI PARTS #
SOPORTES / TRANSMISSION & MOTOR MOUNTS			
V8 6.3	08-10	SOPORTE PARA MOTOR IZQUIERDO	7630-H



CL-500

SOPORTES / TRANSMISSION & MOTOR MOUNTS			
V8 5.0	98-06	SOPORTE PARA TRANSMISIÓN AUT.	7466



CL-550

SOPORTES / TRANSMISSION & MOTOR MOUNTS			
V8 5.5	07-08	SOPORTE PARA MOTOR IZQUIERDO	7630-H



CL-600

SOPORTES / TRANSMISSION & MOTOR MOUNTS			
V12 5.5	03-06	SOPORTE PARA TRANSMISIÓN AUT.	7466
V12 5.8	01-02		
V12 6.0	98-99		



CLK-55 AMG

		APLICACIÓN / DESCRIPTION	DAI PARTS #
SOPORTES / TRANSMISSION & MOTOR MOUNTS			
V8 5.5	01-05	SOPORTE PARA TRANSMISIÓN AUT.	7466
	01-06	SOPORTE PARA MOTOR IZQUIERDO	7630-H



CLK-200

		APLICACIÓN / DESCRIPTION	DAI PARTS #
SOPORTES / TRANSMISSION & MOTOR MOUNTS			
L4 2.0	97-02	SOPORTE PARA TRANSMISIÓN	7589



CLK-320

		APLICACIÓN / DESCRIPTION	DAI PARTS #
SOPORTES / TRANSMISSION & MOTOR MOUNTS			
V6 3.2	98-05	SOPORTE PARA TRANSMISIÓN AUT.	7466



CLK-350

		APLICACIÓN / DESCRIPTION	DAI PARTS #
SOPORTES / TRANSMISSION & MOTOR MOUNTS			
V6 5.5	06-08	SOPORTE PARA MOTOR IZQUIERDO	7630-H



CLK-430

  28		APLICACIÓN / DESCRIPTION	DAI PARTS #
SOPORTES / TRANSMISSION & MOTOR MOUNTS			
V8 4.3	99-03	SOPORTE PARA TRANSMISIÓN AUT.	7466
		SOPORTE PARA MOTOR IZQUIERDO	7630-H

CLK-500

SOPORTES / TRANSMISSION & MOTOR MOUNTS			
V8 5.0	03-04	SOPORTE PARA TRANSMISIÓN AUT.	7466

CLS-55 AMG

SOPORTES / TRANSMISSION & MOTOR MOUNTS			
V8 5.0	05-09	SOPORTE PARA TRANSMISIÓN AUT.	7466
	2006	SOPORTE PARA MOTOR IZQUIERDO	7630-H

CLS-63 AMG

SOPORTES / TRANSMISSION & MOTOR MOUNTS			
V8 5.5	07-11	SOPORTE PARA MOTOR IZQUIERDO	7630-H



CLS-500

 		APLICACIÓN / DESCRIPTION	DAI PARTS #
SOPORTES / TRANSMISSION & MOTOR MOUNTS			
V8 5.0	2006	SOPORTE PARA MOTOR IZQUIERDO	7630-H



CLS-550

SOPORTES / TRANSMISSION & MOTOR MOUNTS			
V8 5.5	07-11	SOPORTE PARA TRANSMISIÓN AUT.	7466
	03-11	SOPORTE PARA MOTOR IZQUIERDO Y DERECHO	7630-H



E-6 AMG

SOPORTES / TRANSMISSION & MOTOR MOUNTS			
V8 6.3	07-09	SOPORTE PARA MOTOR IZQUIERDO	7630-H



E-55 AMG

SOPORTES / TRANSMISSION & MOTOR MOUNTS			
V8 5.5	99-06	SOPORTE PARA TRANSMISIÓN AUT.	7466
		SOPORTE PARA MOTOR IZQUIERDO Y DERECHO	7630-H



E-63 AMG

		APLICACIÓN / DESCRIPTION	DAI PARTS #
SOPORTES / TRANSMISSION & MOTOR MOUNTS			
V8 6.3	07-08	SOPORTE PARA MOTOR IZQUIERDO	7630-H

E-200

SOPORTES / TRANSMISSION & MOTOR MOUNTS			
L4 2.0	96-03	SOPORTE PARA TRANSMISIÓN (DIESEL)	7589
L4 2.5	95-99		
L5 2.5			
L4 2.0	95-00	SOPORTE PARA TRANSMISIÓN	7622

E-220

SOPORTES / TRANSMISSION & MOTOR MOUNTS			
L4 2.2	95-99	SOPORTE PARA TRANSMISIÓN (DIESEL)	7622

E-230

SOPORTES / TRANSMISSION & MOTOR MOUNTS			
L4 2.3	95-97	SOPORTE PARA TRANSMISIÓN	7622



E-250

SOPORTES / TRANSMISSION & MOTOR MOUNTS

L4 2.5	10-13	SOPORTE PARA MOTOR IZQUIERDO Y DERECHO	7511-H
	95-99	SOPORTE PARA TRANSMISIÓN (DIESEL)	7622
V6 3.5	06-09	SOPORTE PARA MOTOR IZQUIERDO	7630-H



7630-H

SOPORTES TRANSMISSION & MOTOR MOUNTS



7511-H

7622

E-280



28

APLICACIÓN / DESCRIPTION

**DAI
PARTS #**

SOPORTES / TRANSMISSION & MOTOR MOUNTS

V6 2.8	96-02	SOPORTE PARA TRANSMISIÓN	7589
--------	-------	--------------------------	------

SOPORTES TRANSMISSION & MOTOR MOUNTS



7589

E-290

SOPORTES / TRANSMISSION & MOTOR MOUNTS

L5 2.9	96-99	SOPORTE PARA TRANSMISIÓN (DIESEL)	7589
L5 2.5		SOPORTE PARA TRANSMISIÓN (DIESEL)	7622

SOPORTES TRANSMISSION & MOTOR MOUNTS



7589

7622



E-300

		APLICACIÓN / DESCRIPTION	DAI PARTS #
SOPORTES / TRANSMISSION & MOTOR MOUNTS			
V6 3.0	95-97	SOPORTE PARA TRANSMISIÓN (DIESEL)	7589
		SOPORTE PARA TRANSMISIÓN (DIESEL)	7622
	09-14	SOPORTE PARA MOTOR IZQUIERDO Y DERECHO	7511-H

E-320

SOPORTES / TRANSMISSION & MOTOR MOUNTS			
L6 3.2	94-95	SOPORTE PARA MOTOR IZQUIERDO Y DERECHO	7336-H
L6 3.2	05-06	SOPORTE PARA TRANSMISIÓN AUT.	7466
V6 3.0	2007		
V6 3.2	96-06		
L6 3.2	05-06	SOPORTE PARA MOTOR IZQUIERDO	7630-H
V6 3.0	07-09		
V6 3.2	98-05		
V6 3.2	95-97	SOPORTE PARA TRANSMISIÓN	7622



E-350

 		APLICACIÓN / DESCRIPTION	DAI PARTS #
SOPORTES / TRANSMISSION & MOTOR MOUNTS			
V6 3.5	06-09	SOPORTE PARA MOTOR IZQUIERDO	7630-H



E-420

SOPORTES / TRANSMISSION & MOTOR MOUNTS			
V8 4.2	1997	SOPORTE PARA TRANSMISIÓN AUT.	7466



E-430

SOPORTES / TRANSMISSION & MOTOR MOUNTS			
V8 4.3	98-02	SOPORTE PARA TRANSMISIÓN AUT.	7466
		SOPORTE PARA MOTOR IZQUIERDO	7630-H



E-500

SOPORTES / TRANSMISSION & MOTOR MOUNTS			
V8 5.0	03-06	SOPORTE PARA TRANSMISIÓN AUT.	7466
		SOPORTE PARA MOTOR IZQUIERDO	7630-H



E-550

		APLICACIÓN / DESCRIPTION	DAI PARTS #
SOPORTES / TRANSMISSION & MOTOR MOUNTS			
V8 5.5	07-08	SOPORTE PARA TRANSMISIÓN AUT.	7466

SOPORTES TRANSMISSION & MOTOR MOUNTS

7466
G-500

SOPORTES / TRANSMISSION & MOTOR MOUNTS			
V8 5.0	02-06	SOPORTE PARA TRANSMISIÓN AUT.	7466

SOPORTES TRANSMISSION & MOTOR MOUNTS

7466
ML-270

SOPORTES / TRANSMISSION & MOTOR MOUNTS			
V6 2.7	91-05	SOPORTE PARA TRANSMISIÓN (DIESEL)	7623

SOPORTES TRANSMISSION & MOTOR MOUNTS

7623
ML-320

SOPORTES / TRANSMISSION & MOTOR MOUNTS			
V6 3.0	05-11	SOPORTE PARA TRANSMISIÓN	7621
V6 3.2	98-03	SOPORTE PARA MOTOR IZQUIERDO Y DERECHO	7455

SOPORTES TRANSMISSION & MOTOR MOUNTS

7455

7621

CONTINUACIÓN... ML-320

 		APLICACIÓN / DESCRIPTION	DAI PARTS #
SOPORTES / TRANSMISSION & MOTOR MOUNTS			
V6 3.2	98-03	SOPORTE PARA TRANSMISIÓN	7623



ML-350

SOPORTES / TRANSMISSION & MOTOR MOUNTS			
V6 3.0	05-11	SOPORTE PARA TRANSMISIÓN	7621
V6 3.7	03-05	SOPORTE PARA MOTOR IZQUIERDO Y DERECHO	7455
		SOPORTE PARA TRANSMISIÓN	7623



ML-400

SOPORTES / TRANSMISSION & MOTOR MOUNTS			
V8 4.0	01-05	SOPORTE PARA TRANSMISIÓN (DIESEL)	7623



ML-430

  28		APLICACIÓN / DESCRIPTION	DAI PARTS #
SOPORTES / TRANSMISSION & MOTOR MOUNTS			
V8 4.2	99-01	SOPORTE PARA MOTOR IZQUIERDO Y DERECHO	7455
		SOPORTE PARA TRANSMISIÓN	7623

ML-450

SOPORTES / TRANSMISSION & MOTOR MOUNTS			
V6 3.5	10-11	SOPORTE PARA TRANSMISIÓN	7621

ML-500

SOPORTES / TRANSMISSION & MOTOR MOUNTS			
V8 5.0	02-06	SOPORTE PARA MOTOR IZQUIERDO Y DERECHO	7455
	02-05	SOPORTE PARA TRANSMISIÓN	7623

R-63 AMG

SOPORTES / TRANSMISSION & MOTOR MOUNTS			
V8 6.3	05-07	SOPORTE PARA TRANSMISIÓN	7621



S-55 AMG

		APLICACIÓN / DESCRIPTION	DAI PARTS #
SOPORTES / TRANSMISSION & MOTOR MOUNTS			
V8 5.5	01-06	SOPORTE PARA TRANSMISIÓN AUT.	7466
	03-05	SOPORTE PARA MOTOR IZQUIERDO Y DERECHO	7630-H



S-63 AMG

		APLICACIÓN / DESCRIPTION	DAI PARTS #
SOPORTES / TRANSMISSION & MOTOR MOUNTS			
V8 6.3	08-10	SOPORTE PARA MOTOR IZQUIERDO Y DERECHO	7630-H



S-65 AMG

		APLICACIÓN / DESCRIPTION	DAI PARTS #
SOPORTES / TRANSMISSION & MOTOR MOUNTS			
V12 6.0	2006	SOPORTE PARA TRANSMISIÓN AUT.	7466



S-320

		APLICACIÓN / DESCRIPTION	DAI PARTS #
SOPORTES / TRANSMISSION & MOTOR MOUNTS			
L6 3.2	97-99	SOPORTE PARA TRANSMISIÓN AUT.	7466



S-420

		APLICACIÓN / DESCRIPTION	DAI PARTS #
SOPORTES / TRANSMISSION & MOTOR MOUNTS			
V8 4.2	96-99	SOPORTE PARA TRANSMISIÓN AUT.	7466

S-430

SOPORTES / TRANSMISSION & MOTOR MOUNTS			
V8 4.3	00-03	SOPORTE PARA TRANSMISIÓN AUT.	7466
	00-05	SOPORTE PARA MOTOR IZQUIERDO	7630-H

S-500

SOPORTES / TRANSMISSION & MOTOR MOUNTS			
V8 5.0	96-06	SOPORTE PARA TRANSMISIÓN AUT.	7466
	00-06	SOPORTE PARA MOTOR IZQUIERDO	7630-H

S-550

SOPORTES / TRANSMISSION & MOTOR MOUNTS			
V8 5.5	07-11	SOPORTE PARA MOTOR IZQUIERDO Y DERECHO	7630-H



S-600

		APLICACIÓN / DESCRIPTION	DAI PARTS #
SOPORTES / TRANSMISSION & MOTOR MOUNTS			
V12 5.8	01-02	SOPORTE PARA TRANSMISIÓN AUT.	7466
V12 6.0	96-99		



SL-55

SOPORTES / TRANSMISSION & MOTOR MOUNTS			
V8 5.5	03-06	SOPORTE PARA MOTOR IZQUIERDO Y DERECHO	7630-H



SL-55 AMG

SOPORTES / TRANSMISSION & MOTOR MOUNTS			
V8 5.5	03-08	SOPORTE PARA TRANSMISIÓN AUT.	7466
V8 6.0	05-09		



SL-65 AMG

SOPORTES / TRANSMISSION & MOTOR MOUNTS			
V8 5.0	01-06	SOPORTE PARA TRANSMISIÓN AUT.	7466
V8 5.5	03-05	SOPORTE PARA MOTOR IZQUIERDO Y DERECHO	7630-H



SL-320

		APLICACIÓN / DESCRIPTION	DAI PARTS #
SOPORTES / TRANSMISSION & MOTOR MOUNTS			
L6 3.2	1997	SOPORTE PARA TRANSMISIÓN AUT.	7466

SL-500

SOPORTES / TRANSMISSION & MOTOR MOUNTS			
V8 5.0	96-06	SOPORTE PARA TRANSMISIÓN AUT.	7466
	03-06	SOPORTE PARA MOTOR IZQUIERDO Y DERECHO	7630-H

SL-550

SOPORTES / TRANSMISSION & MOTOR MOUNTS			
V8 5.0	96-06	SOPORTE PARA TRANSMISIÓN AUT.	7466
	03-06	SOPORTE PARA MOTOR IZQUIERDO Y DERECHO	7630-H

SL-600

SOPORTES / TRANSMISSION & MOTOR MOUNTS			
V12 6.0	96-02	SOPORTE PARA TRANSMISIÓN AUT.	7466
V8 5.5	07-09	SOPORTE PARA MOTOR IZQUIERDO Y DERECHO	7630-H



SLK-200

28		APLICACIÓN / DESCRIPTION	DAI PARTS #
SOPORTES / TRANSMISSION & MOTOR MOUNTS			
L4 2.0	96-00	SOPORTE PARA TRANSMISIÓN (DIESEL)	7589



SLK-230

SOPORTES / TRANSMISSION & MOTOR MOUNTS			
L4 2.3	98-04	SOPORTE PARA TRANSMISIÓN AUT.	7466



SLK-280

SOPORTES / TRANSMISSION & MOTOR MOUNTS			
V6 3.0	06-08	SOPORTE PARA MOTOR IZQUIERDO Y DERECHO	7630-H
V6 3.5			



SLK-300

SOPORTES / TRANSMISSION & MOTOR MOUNTS			
V6 3.0	09-11	SOPORTE PARA MOTOR IZQUIERDO Y DERECHO	7630-H
V6 3.5			



SLK-320

 		APLICACIÓN / DESCRIPTION	DAI PARTS #
SOPORTES / TRANSMISSION & MOTOR MOUNTS			
V6 3.2	01-04	SOPORTE PARA TRANSMISIÓN AUT.	7466



SLK-350

SOPORTES / TRANSMISSION & MOTOR MOUNTS			
V6 3.0	05-11	SOPORTE PARA MOTOR IZQUIERDO Y DERECHO	7630-H
V6 3.5			



SPRINTER

SOPORTES / TRANSMISSION & MOTOR MOUNTS			
L4 2.1	03-09	SOPORTE PARA MOTOR IZQUIERDO Y DERECHO	7213



MERCURY

CAPRY

28	APLICACIÓN / DESCRIPTION	DAI PARTS #	DAI KIT PARTS #
BASES PARA AMORTIGUADOR / STRUT MOUNTS			
79-91	REPUESTO BASE DE AMORTIGUADOR FRONTAL IZQUIERDA Y DERECHA		6729-KIT

BASES PARA AMORTIGUADOR STRUT MOUNTS



6729-KIT

GRAND MARQUIS

BASES PARA AMORTIGUADOR / STRUT MOUNTS			
83-86	REPUESTO BASE DE AMORTIGUADOR FRONTAL IZQUIERDA Y DERECHA		6729-KIT

BASES PARA AMORTIGUADOR STRUT MOUNTS



6729-KIT

28	APLICACIÓN / DESCRIPTION	DAI PARTS #
MISCELÁNEOS / AUTOMOTIVE RUBBER PARTS		
95-02	TORNILLO ESTABILIZADOR FRONTAL	DAI-K-8953
	GOMA SUJETADORA DE ESCAPE	6561

MISCELÁNEOS AUTOMOTIVE RUBBER PARTS



DAI-K-8953



6561

LYNX

BASES PARA AMORTIGUADOR / STRUT MOUNTS			
81-87	BASE PARA AMORTIGUADOR FRONTAL IZQUIERDA Y DERECHA	1855	
	BASE PARA AMORTIGUADOR TRASERA IZQUIERDA Y DERECHA		6734-KIT

BASES PARA AMORTIGUADOR STRUT MOUNTS



1855



6734-KIT



CONTINUACIÓN... LYNX

28	APLICACIÓN / DESCRIPTION	DAI PARTS #	DAI KIT PARTS #
BASES PARA AMORTIGUADOR / STRUT MOUNTS			
81-87	BASE PARA AMORTIGUADOR FRONTAL IZQUIERDA Y DERECHA	6784	6784-KIT
	BALERO PARA BASES DE AMORTIGUADOR 1855, 6784 Y 6784-KIT	6138	

MARINER

28	APLICACIÓN / DESCRIPTION	DAI PARTS #	
SOPORTES / TRANSMISSION & MOTOR MOUNTS			
L4 2.3	01-05	SOPORTE PARA MOTOR TRASERO	7117
		SOPORTE PARA TRANSMISIÓN AUT.	7118
		SOPORTE PARA MOTOR DERECHO	7237-H
	06-12	SOPORTE PARA MOTOR FRONTAL	7281
		SOPORTE PARA MOTOR TRASERO	7282
		SOPORTE PARA MOTOR DERECHO	7339-H
		SOPORTE PARA TRANSMISIÓN	7340
V6 3.0	01-12	SOPORTE PARA MOTOR TRASERO	7117
		SOPORTE PARA TRANSMISIÓN AUT.	7118
		SOPORTE PARA MOTOR DERECHO	7237-H



CONTINUACIÓN... MARINER

	APLICACIÓN / DESCRIPTION	DAI PARTS #	DAI KIT PARTS #
BASES PARA AMORTIGUADOR / STRUT MOUNTS			
01-12	BASE PARA AMORTIGUADOR FRONTAL IZQUIERDA Y DERECHA		7299-KIT
13-15	BASE PARA AMORTIGUADOR FRONTAL IZQUIERDA Y DERECHA		7182



		APLICACIÓN / DESCRIPTION	DAI PARTS #
MISCELÁNEOS / AUTOMOTIVE RUBBER PARTS			
	01-04	TORNILLO ESTABILIZADOR FRONTAL	DAI-2108004
	01-12	BUJE PARA HORQUILLA INFERIOR GRANDE	DAI-1408007
		BUJE PARA HORQUILLA INFERIOR CHICO	DAI-1408063
	05-12	TORNILLO ESTABILIZADOR FRONTAL (LARGO)	DAI-2108002



MILAN

SOPORTES / TRANSMISSION & MOTOR MOUNTS			
L4 2.3	07-08	SOPORTE PARA MOTOR TRASERO	7249
		SOPORTE PARA MOTOR DERECHO	7250-H



CONTINUACIÓN... MILAN

	 28	APLICACIÓN / DESCRIPTION	DAI PARTS #
SOPORTES / TRANSMISSION & MOTOR MOUNTS			
L4 2.3	07-08	SOPORTE PARA MOTOR DERECHO	7255-H
		SOPORTE PARA TRANSMISIÓN	7276-H
L4 2.5	10-11	REPUESTO PARA SOPORTE DE TRANSMISIÓN AUT.	7715-9
V6 3.0	07-08	SOPORTE PARA MOTOR TRASERO	7249
		SOPORTE PARA MOTOR DERECHO	7250-H
		SOPORTE PARA MOTOR DERECHO	7255-H
		SOPORTE PARA TRANSMISIÓN	7276-H
	10-11	SOPORTE PARA TRANSMISIÓN	7651-H
		REPUESTO PARA SOPORTE DE TRANSMISIÓN (SOLIDO)	7651-9

**SOPORTES
TRANSMISSION & MOTOR MOUNTS**

7249

7250-H

7255-H

7276-H



7651-9
7651-H
7715-9

 28	APLICACIÓN / DESCRIPTION	DAI PARTS #	DAI KIT PARTS #
BASES PARA AMORTIGUADOR / STRUT MOUNTS			
06-12	BASE PARA AMORTIGUADOR FRONTAL IZQUIERDA Y DERECHA	7597	

**BASES PARA AMORTIGUADOR
STRUT MOUNTS**

7597

CONTINUACIÓN... MILAN

 		APLICACIÓN / DESCRIPTION	DAI PARTS #
MISCELÁNEOS / AUTOMOTIVE RUBBER PARTS			
06-12		TORNILLO ESTABILIZADOR TRASERO	DAI-2113005
		BUJE PARA HORQUILLA INFERIOR (CURVA)	DAI-1408066
		BUJE PARA HORQUILLA INFERIOR (INTERIOR AL AMORTIGUADOR)	DAI-1408067



MOUNTAINEER

SOPORTES / TRANSMISSION & MOTOR MOUNTS				
V6 4.0	98-01	SOPORTE PARA MOTOR DERECHO	6884	
		SOPORTE PARA TRANSMISIÓN	6890	
		SOPORTE PARA TRANSMISIÓN	6924	
	02-10		SOPORTE PARA TRANSMISIÓN	7702
			SOPORTE PARA MOTOR IZQUIERDO	7177
			SOPORTE PARA MOTOR DERECHO	7176
			SOPORTE PARA TRANSMISIÓN (4X4)	7178



CONTINUACIÓN... MOUNTAINEER

 28		APLICACIÓN / DESCRIPTION	DAI PARTS #
SOPORTES / TRANSMISSION & MOTOR MOUNTS			
V6 4.6	02-10	SOPORTE PARA MOTOR IZQUIERDO	7177
		SOPORTE PARA MOTOR DERECHO	7176
		SOPORTE PARA TRANSMISIÓN (4X4)	7178
V8 5.0	97-01	SOPORTE PARA TRANSMISIÓN	7702



MISCELÁNEOS / AUTOMOTIVE RUBBER PARTS			
	97-05	GOMA PARA BARRA ESTABILIZADORA 1"	64716
	02-06	GOMA PARA BARRA ESTABILIZADORA 3/4"	64703
	06-10	TORNILLO ESTABILIZADOR FRONTAL (MISMO K-8639)	DAI-K-8702



MYSTIQUE

28		APLICACIÓN / DESCRIPTION	DAI PARTS #	DAI KIT PARTS #
BASES PARA AMORTIGUADOR / STRUT MOUNTS				
95-01		BASE PARA AMORTIGUADOR FRONTAL IZQUIERDA Y DERECHA	6753	6753-KIT
		BASE PARA AMORTIGUADOR TRASERA IZQUIERDA Y DERECHA	6754	6754-KIT
		BALERO PARA BASE DE AMORTIGUADOR FRONTAL IZQUIERDO Y DERECHO	6146	



MONTEGO

28		APLICACIÓN / DESCRIPTION	DAI PARTS #
SOPORTES / TRANSMISSION & MOTOR MOUNTS			
V6 3.0	05-07	SOPORTE PARA MOTOR FRONTAL	7542-H
		SOPORTE PARA MOTOR TRASERO	7543-H



SABLE

SOPORTES / TRANSMISSION & MOTOR MOUNTS			
V6 3.0	00-05	SOPORTE PARA MOTOR TRASERO DERECHO	7270
	08-09	SOPORTE PARA MOTOR FRONTAL	7542-H



CONTINUACIÓN... SABLE

		APLICACIÓN / DESCRIPTION	DAI PARTS #
SOPORTES / TRANSMISSION & MOTOR MOUNTS			
V6 3.0	08-09	SOPORTE PARA MOTOR TRASERO	7543-H





MISCELÁNEOS / AUTOMOTIVE RUBBER PARTS		
94-06	TOPE PARA AMORTIGUADOR FRONTAL Y TRASERO IZQUIERDO Y DERECHO	D-0621

TRACER

		APLICACIÓN / DESCRIPTION	DAI PARTS #	DAI KIT PARTS #
BASES PARA AMORTIGUADOR / STRUT MOUNTS				
91-97	BASE PARA AMORTIGUADOR FRONTAL IZQUIERDA Y DERECHA	7029	7029-KIT	
	BALERO PARA BASE PARA AMORTIGUADOR FRONTAL IZQUIERDA Y DERECHA	6148		



CONTINUACIÓN... TRACER

 		APLICACIÓN / DESCRIPTION	DAI PARTS #
CUBRE POLVOS / C.V. BOOTS			
91-97		CUBRE POLVO IZQUIERDO Y DERECHO LADO RUEDA	6378
		CUBRE POLVO IZQUIERDO Y DERECHO LADO CAJA	6397



VILLAGER

SOPORTES / TRANSMISSION & MOTOR MOUNTS			
V6 3.0	93-98	SOPORTE PARA TRANSMISIÓN	7167
		SOPORTE PARA MOTOR FRONTAL	7168
		SOPORTE PARA MOTOR TRASERO	7169
		SOPORTE PARA MOTOR TRASERO DERECHO	7170
V6 3.3	99-02	SOPORTE PARA TRANSMISIÓN	7167
		SOPORTE PARA MOTOR TRASERO DERECHO	7170
		SOPORTE PARA MOTOR FRONTAL	7171



 		APLICACIÓN / DESCRIPTION	DAI PARTS #	DAI KIT PARTS #
BASES PARA AMORTIGUADOR / STRUT MOUNTS				
93-02		BASE PARA AMORTIGUADOR FRONTAL IZQUIERDA Y DERECHA		7221-KIT



CONTINUACIÓN... VILLAGER

28		APLICACIÓN / DESCRIPTION	DAI PARTS #	MISCELÁNEOS AUTOMOTIVE RUBBER PARTS	
MISCELÁNEOS / AUTOMOTIVE RUBBER PARTS					
93-02		TOPE PARA AMORTIGUADOR FRONTAL IZQUIERDO Y DERECHO	D-0619		
		TORNILLO ESTABILIZADOR FRONTAL	64620		
		TORNILLO ESTABILIZADOR FRONTAL DERECHO	DAI-2116024		
		TORNILLO ESTABILIZADOR FRONTAL IZQUIERDO	DAI-2116025		
		BUJE PARA HORQUILLA GRANDE	DAI-54570-6B010		
		BUJES PARA HORQUILLA INFERIOR CHICO	DAI-54560-0B00		

DAI-2116024

DAI-2116025

DAI-54570-6B010

DAI-54560-0B00

MINI

COOPER

		APLICACIÓN / DESCRIPTION	DAI PARTS #
SOPORTES / TRANSMISSION & MOTOR MOUNTS			
L4 1.6	02-04	SOPORTE PARA MOTOR TRASERO DERECHO	7600
	02-08	SOPORTE PARA MOTOR TRASERO TORQUE STRUT	7612
	04-08	SOPORTE PARA MOTOR DERECHO	7579-H

SOPORTES TRANSMISSION & MOTOR MOUNTS



7579-H



7600



7612

	APLICACIÓN / DESCRIPTION	DAI PARTS #	DAI KIT PARTS #
BASES PARA AMORTIGUADOR / STRUT MOUNTS			
02-08	BASE PARA AMORTIGUADOR DELANDERA IZQUIERDA Y DERECHA	7626	

BASES PARA AMORTIGUADOR STRUT MOUNTS



7626



DAI MITSUBISHI
ASX

28		APLICACIÓN / DESCRIPTION	DAI PARTS #
MISCELÁNEOS / AUTOMOTIVE RUBBER PARTS			
13-15		BUJE PARA HORQUILLA INFERIOR CHICO	DAI-1415001
		BUJE PARA HORQUILLA GRANDE	DAI-1415002

**MISCELÁNEOS
AUTOMOTIVE RUBBER PARTS**

DAI-1415001

DAI-1415002
ECLIPSE
SOPORTES / TRANSMISSION & MOTOR MOUNTS

L4 1.8	90-94	SOPORTE PARA TRANSMISIÓN AUT.	6862
L4 2.0	90-94	SOPORTE PARA TRANSMISIÓN AUT.	6862
	95-99	SOPORTE PARA TRANSMISIÓN	7423
		SOPORTE PARA MOTOR FRONTAL	7787
		SOPORTE PARA MOTOR DERECHO	7788
L4 2.4	94-98	SOPORTE PARA MOTOR DERECHO	7788
	96-05	SOPORTE PARA TRANSMISIÓN	7423
	06-11	SOPORTE PARA MOTOR FRONTAL	7416
		REPUESTO PARA SOPORTE DE MOTOR FRONTAL (7416)	7416-9
	00-05	REPUESTO PARA SOPORTE DE MOTOR DERECHO	7417-9

**SOPORTES
TRANSMISSION & MOTOR MOUNTS**

6862

7416

7416-9

7417-9

7423

7787

7788

CONTINUACIÓN... ECLIPSE

 		APLICACIÓN / DESCRIPTION	DAI PARTS #
SOPORTES / TRANSMISSION & MOTOR MOUNTS			
L4 2.4	00-05	SOPORTE PARA MOTOR FRONTAL AUT.	7422
		SOPORTE PARA MOTOR FRONTAL	7784
		SOPORTE PARA MOTOR TRASERO	7752
	2005	SOPORTE PARA TRANSMISIÓN AUT.	7734
	06-08	REPUESTO PARA SOPORTE DE TRANSMISIÓN	7418-9
06-11	REPUESTO PARA SOPORTE DE MOTOR TRASERO AUT.	7415-9	
V6 3.0	99-05	REPUESTO PARA SOPORTE DE TRANSMISIÓN	7418-9
	00-05	SOPORTE PARA MOTOR FRONTAL	7784
		SOPORTE PARA MOTOR TRASERO	7786
V6 3.8	06-11	REPUESTO PARA SOPORTE DE MOTOR TRASERO AUT.	7415-9
		SOPORTE PARA MOTOR FRONTAL	7416
		REPUESTO PARA SOPORTE DE MOTOR FRONTAL (7416)	7416-9

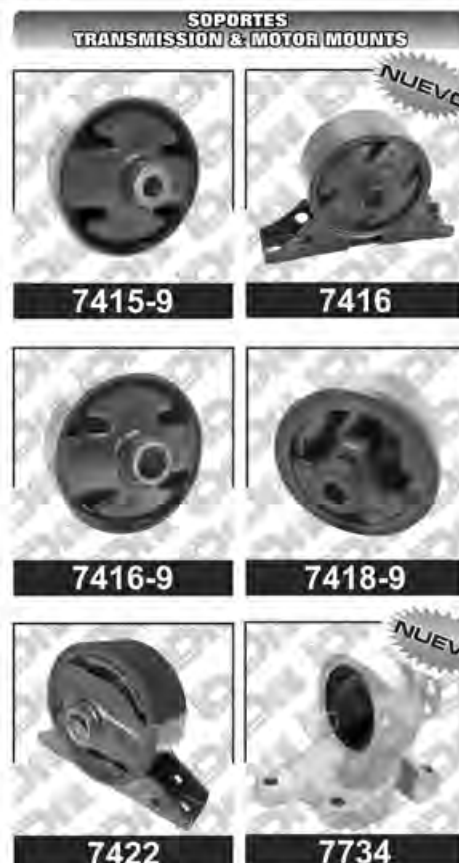

 	APLICACIÓN / DESCRIPTION	DAI PARTS #	DAI KIT PARTS #
BASES PARA AMORTIGUADOR / STRUT MOUNTS			
00-05	BASE PARA AMORTIGUADOR FRONTAL IZQUIERDA Y DERECHA		7319-KIT



CONTINUACIÓN... ECLIPSE

 		APLICACIÓN / DESCRIPTION	DAI PARTS #
MISCELÁNEOS / AUTOMOTIVE RUBBER PARTS			
00-05		TORNILLO ESTABILIZADOR FRONTAL IZQUIERDO	DAI-2115001
		TORNILLO ESTABILIZADOR FRONTAL DERECHO	DAI-2115002

ENDEAVOR



SOPORTES / TRANSMISSION & MOTOR MOUNTS			
V6 3.8	04-09	SOPORTE PARA MOTOR FRONTAL	7416
		REPUESTO PARA SOPORTE DE MOTOR FRONTAL (7416)	7416-9
	04-10	REPUESTO PARA SOPORTE DE TRANSMISIÓN	7418-9

GALANT

SOPORTES / TRANSMISSION & MOTOR MOUNTS			
L4 2.0	85-93	SOPORTE PARA TRANSMISIÓN STD.	6862
L4 2.4	85-87	SOPORTE PARA TRANSMISIÓN	6862



CONTINUACIÓN... GALANT

		 28	APLICACIÓN / DESCRIPTION	DAI PARTS #
SOPORTES / TRANSMISSION & MOTOR MOUNTS				
L4 2.4	94-03		SOPORTE PARA TRANSMISIÓN	7423
	94-96		SOPORTE PARA MOTOR FRONTAL	7787
	94-98		SOPORTE PARA MOTOR DERECHO	7788
	99-03		REPUESTO PARA SOPORTE DE MOTOR DERECHO	7417-9
			SOPORTE PARA TRANSMISIÓN AUT.	7734
			SOPORTE PARA MOTOR TRASERO	7752
	99-05		SOPORTE PARA MOTOR FRONTAL AUT.	7422
	04-10		REPUESTO PARA SOPORTE DE TRANSMISIÓN	7418-9
04-11		SOPORTE PARA MOTOR FRONTAL	7416	
		REPUESTO PARA SOPORTE DE MOTOR FRONTAL (7416)	7416-9	
V6 3.0	99-03		SOPORTE PARA MOTOR FRONTAL	7784
			SOPORTE PARA MOTOR TRASERO	7786
V6 3.8	04-08		REPUESTO PARA SOPORTE DE TRANSMISIÓN	7418-9
	04-11		SOPORTE DE MOTOR FRONTAL	7416
			REPUESTO PARA SOPORTE DE MOTOR FRONTAL (7416)	7416-9



CONTINUACIÓN... GALANT



28	APLICACIÓN / DESCRIPTION	DAI PARTS #	DAI KIT PARTS #
BASES PARA AMORTIGUADOR / STRUT MOUNTS			
94-98	BASE PARA AMORTIGUADOR FRONTAL IZQUIERDA Y DERECHA	6736	6736-KIT
	BASE PARA AMORTIGUADOR FRONTAL IZQUIERDA Y DERECHA	6755	
00-03	BASE PARA AMORTIGUADOR FRONTAL IZQUIERDA Y DERECHA		7319-KIT



28	APLICACIÓN / DESCRIPTION	DAI PARTS #
MISCELÁNEOS / AUTOMOTIVE RUBBER PARTS		
	BUJE PARA MUELLE (POLIURETANO)	9169
00-03	TORNILLO ESTABILIZADOR FRONTAL IZQUIERDO	DAI-2115001
	TORNILLO ESTABILIZADOR FRONTAL DERECHO	DAI-2115002



L-200

		  28	APLICACIÓN / DESCRIPTION	DAI PARTS #
SOPORTES / TRANSMISSION & MOTOR MOUNTS				
L4 2.4	05-16		SOPORTE PARA TRANSMISIÓN 4X4 DIESEL Y GASOLINA	7775
	08-16		SOPORTE PARA MOTOR IZQUIERDO Y DERECHO DIESEL Y GASOLINA 4X2 Y 4X4)	7631
L4 2.5	06-16		SOPORTE PARA TRANSMISIÓN 4X4 DIESEL Y GASOLINA	7775
	08-16		SOPORTE PARA MOTOR IZQUIERDO Y DERECHO DIESEL Y GASOLINA 4X2 Y 4X4)	7631



MISCELÁNEOS / AUTOMOTIVE RUBBER PARTS			
		BUJE PARA MUELLE (POLIURETANO)	9169



LANCER

SOPORTES / TRANSMISSION & MOTOR MOUNTS			
L4 2.0	02-07	REPUESTO SOPORTE PARA MOTOR TRASERO	7209-9
	03-10	SOPORTE PARA TRANSMISIÓN	7360



CONTINUACIÓN... LANCER

	28	APLICACIÓN / DESCRIPTION	DAI PARTS #
--	----	--------------------------	-------------

SOPORTES / TRANSMISSION & MOTOR MOUNTS

L4 2.0 L4 2.4	02-06	SOPORTE PARA MOTOR TRASERO	7640
	02-07	SOPORTE PARA MOTOR TRASERO STD.	7209
		SOPORTE PARA MOTOR FRONTAL AUT.	7308
		REPUESTO PARA SOPORTE MOTOR FRONTAL AUT. (7308)	7308-9
	01-12	SOPORTE PARA MOTOR DERECHO	7314
		SOPORTE PARA TRANSMISIÓN AUT.	7358
		SOPORTE PARA MOTOR TRASERO STD.	7359
	01-15	SOPORTE PARA MOTOR TRASERO AUT.	7414
REPUESTO PARA SOPORTE DE MOTOR TRASERO AUT.		7414-9	
08-17	SOPORTE PARA TRANSMISIÓN STD.	7749	

L4 2.4	01-12	SOPORTE PARA MOTOR DERECHO	7348
		REPUESTO PARA SOPORTE MOTOR DERECHO (7348) TRANSMISIÓN AUT. Y STD. (7358)	7348-9
	02-07	REPUESTO PARA SOPORTE DE MOTOR TRASERO	7209-9
	04-06	SOPORTE PARA MOTOR FRONTAL	7687

**SOPORTES
TRANSMISSION & MOTOR MOUNTS**

7209

7209-9

7308

7308-9

7314

7348

7348-9

7358

7359

7414

7414-9

7640

7687

7749

CONTINUACIÓN... LANCER

28	APLICACIÓN / DESCRIPTION	DAI PARTS #	DAI KIT PARTS #
BASES PARA AMORTIGUADOR / STRUT MOUNTS			
85-89	BASE PARA AMORTIGUADOR FRONTAL IZQUIERDA Y DERECHA	6641	6758-KIT
	BALERO PARA BASES DE AMORTIGUADOR 6641 Y 6758-KIT	6141	



28	APLICACIÓN / DESCRIPTION	DAI PARTS #
CUBRE POLVOS / C.V. BOOTS		
03-06	CUBRE POLVO IZQUIERDO Y DERECHO DE DIRECCIÓN	63158
	CUBRE POLVO IZQUIERDO Y DERECHO LADO RUEDA	63165
08-15	CUBRE POLVO IZQUIERDO Y DERECHO LADO CAJA AUT. (TRIPOIDE)	63166



CONTINUACIÓN... LANCER

		APLICACIÓN / DESCRIPTION	DAI PARTS #	MISCELÁNEOS / AUTOMOTIVE RUBBER PARTS	
MISCELÁNEOS / AUTOMOTIVE RUBBER PARTS					
		BUJE PARA MUELLE (POLIURETANO)	9169		
03-07		TORNILLO ESTABILIZADOR DELANTERO	DAI-2115006		
03-16		BUJE PARA HORQUILLA GRANDE	DAI-1415002		
		BUJE PARA HORQUILLA INFERIOR CHICO	DAI-1415001		

DAI-1415002

DAI-2115006
OUTLANDER

SOPORTES / TRANSMISSION & MOTOR MOUNTS				SOPORTES / TRANSMISSION & MOTOR MOUNTS	
L4 2.0	04-12	SOPORTE PARA TRANSMISIÓN	7358		
		SOPORTE PARA MOTOR TRASERO	7359		
	11-16	SOPORTE PARA TRANSMISIÓN STD.	7749		
L4 2.4	03-06	REPUESTO PARA SOPORTE DE MOTOR TRASERO (7209)	7209-9		
		SOPORTE PARA MOTOR DERECHO	7665-H		
		SOPORTE PARA MOTOR FRONTAL	7687		
	04-12	SOPORTE PARA MOTOR DERECHO	7348		
		REPUESTO PARA SOPORTE MOTOR DERECHO (7348) TRANSMISIÓN AUT. Y STD. (7358)	7348-9		

7359

7665-H

7687

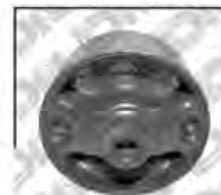
7749

7209-9

7348-9

7358

CONTINUACIÓN... OUTLANDER

 		APLICACIÓN / DESCRIPTION	DAI PARTS #
SOPORTES / TRANSMISSION & MOTOR MOUNTS			
L4 2.4	04-12	SOPORTE PARA TRANSMISIÓN AUT.	7358
		SOPORTE PARA MOTOR TRASERO	7359
		REPUESTO PARA SOPORTE DE MOTOR TRASERO (7414)	7414-9
	05-06	SOPORTE PARA MOTOR TRASERO STD.	7209
		SOPORTE PARA MOTOR TRASERO	7640
		SOPORTE PARA MOTOR TRASERO	7765
08-13	SOPORTE PARA MOTOR TRASERO	7414	
V6 3.0	07-11	SOPORTE PARA MOTOR TRASERO	7765
	07-13	SOPORTE PARA MOTOR TRASERO	7414
		SOPORTE PARA TRANSMISIÓN STD.	7749



CUBRE POLVOS / C.V. BOOTS

03-06	CUBRE POLVO IZQUIERDO Y DERECHO LADO RUEDA	63156
	CUBRE POLVO IZQUIERDO Y DERECHO LADO CAJA (CON TRIPOIDE)	63157



CONTINUACIÓN... OUTLANDER



	28	APLICACIÓN / DESCRIPTION	DAI PARTS #
CUBRE POLVOS / C.V. BOOTS			
	03-06	CUBRE POLVO IZQUIERDO Y DERECHO DE DIRECCIÓN	63158
	07-13	CUBRE POLVO IZQUIERDO Y DERECHO LADO RUEDA	63159
	07-15	CUBRE POLVO IZQUIERDO Y DERECHO LADO CAJA (CON TRIPOIDE)	63160

MISCELÁNEOS / AUTOMOTIVE RUBBER PARTS

03-06	TORNILLO ESTABILIZADOR FRONTAL	DAI-2115005
	TORNILLO ESTABILIZADOR TRASERO DERECHO	DAI-2115008
	TORNILLO ESTABILIZADOR TRASERO IZQUIERDO	DAI-2115007
07-15	BUJE PARA HORQUILLA GRANDE	DAI-1415002
	BUJE PARA HORQUILLA INFERIOR CHICO	DAI-1415001



PICK UP

  28		APLICACIÓN / DESCRIPTION	DAI PARTS #
MISCELÁNEOS / AUTOMOTIVE RUBBER PARTS			
		COPLÉ PARA DIRECCIÓN (SINFIN DE .650" 2 PERNOS GRUESOS)	619
		GALLETAS PARA DIRECCIÓN STD. Y HID. (2 PERNOS GRUESOS CON BUJES COMPLETO 619 Y 630)	641



VARIOS

MISCELÁNEOS / AUTOMOTIVE RUBBER PARTS			
		GALLETAS PARA DIRECCIÓN STD. Y HID. (2 PERNOS DELGADOS CON BUJES COMPLETO 618)	640
		BUJE PARA MUELLE (LARGO POLIURETANO)	9133
		BUJE PARA MUELLE (CORTO POLIURETANO)	9134



NISSAN

210

  28		APLICACIÓN / DESCRIPTION	DAI PARTS #
SOPORTES / TRANSMISSION & MOTOR MOUNTS			
L4 1.2	78-82	SOPORTE PARA TRANSMISIÓN AUT.	6820

SOPORTES TRANSMISSION & MOTOR MOUNTS





200 SX

SOPORTES / TRANSMISSION & MOTOR MOUNTS			
L4 1.6	95-98	SOPORTE MOTOR FRONTAL STD.	6684
		REPUESTO PARA SOPORTE DE MOTOR FRONTAL STD. (6684)	6689
		SOPORTE TRANSMISIÓN	6685
		REPUESTO PARA SOPORTE DE MOTOR IZQUIERDO Y DERECHO (6686, 6802, 6685 Y 6854)	1941
		SOPORTE MOTOR DERECHO	6970
		REPUESTO SOPORTE DE MOTOR DERECHO (6970)	6970-9
L4 2.0	95-98	SOPORTE PARA MOTOR FRONTAL STD.	6684
		REPUESTO PARA SOPORTE DE MOTOR FRONTAL STD. (6684)	6689
		SOPORTE PARA TRANSMISIÓN	6685
		REPUESTO PARA SOPORTE DE MOTOR IZQUIERDO Y DERECHO (6686, 6802, 6685 Y 6854)	1941

SOPORTES TRANSMISSION & MOTOR MOUNTS



240 SX

	 28	APLICACIÓN / DESCRIPTION	DAI PARTS #
MISCELÁNEOS / AUTOMOTIVE RUBBER PARTS			
	93-94	TOPE PARA AMORTIGUADOR FRONTAL IZQUIERDO Y DERECHO	D-0620

**MISCELÁNEOS
AUTOMOTIVE RUBBER PARTS**

D-0620
620

SOPORTES / TRANSMISSION & MOTOR MOUNTS			
		BUJE PARA MUELLE (BUJE PARA BALANCIN POLIURETANO)	9164
		GOMA PARA AMORTIGUADOR (POLIURETANO)	9163

**SOPORTES
TRANSMISSION & MOTOR MOUNTS**

9163

9164
720

SOPORTES / TRANSMISSION & MOTOR MOUNTS			
		BUJE PARA MUELLE (BUJE PARA BALANCIN POLIURETANO)	9164
		BUJE TENSOR (TIPO YOYO POLIURETANO)	9170
		BUJE PARA MUELLE (POLIURETANO)	9160

**SOPORTES
TRANSMISSION & MOTOR MOUNTS**

9160

9164

9170

ALMERA

  28		APLICACIÓN / DESCRIPTION	DAI PARTS #
SOPORTES / TRANSMISSION & MOTOR MOUNTS			
L4 1.8	01-05	SOPORTE PARA MOTOR TRASERO	7010
		REPUESTO PARA SOPORTE MOTOR TRASERO (7010)	1944
		SOPORTE PARA MOTOR DERECHO	7038
		SOPORTE PARA TRANSMISIÓN AUT.	7040
		REPUESTO PARA SOPORTES DE MOTOR Y TRANSMISIÓN (7032, 7040 Y 7265)	7217-9
		SOPORTE PARA MOTOR FRONTAL	7067
		SOPORTE PARA TRANSMISIÓN STD.	7069
		REPUESTO PARA SOPORTE DE TRANSMISIÓN STD. (7069)	7069-9



 28		APLICACIÓN / DESCRIPTION	DAI PARTS #	DAI KIT PARTS #
BASES PARA AMORTIGUADOR / STRUT MOUNTS				
01-05	BASE PARA AMORTIGUADOR FRONTAL IZQUIERDA Y DERECHA		7026	7026-KIT
	BASE PARA AMORTIGUADOR TRASERA IZQUIERDA Y DERECHA			7318-KIT



CONTINUACIÓN... ALMERA



 		APLICACIÓN / DESCRIPTION	DAI PARTS #
MISCELÁNEOS / AUTOMOTIVE RUBBER PARTS			
01-05		TORNILLO ESTABILIZADOR FRONTAL	64620
		BUJE PARA EJE TRASERO	64810
		GOMA PARA BARRA ESTABILIZADORA	64715
		BUJE PARA HORQUILLA CHICO	DAI-1416003
		BUJE PARA HORQUILLA GRANDE	DAI-1416004
		GOMA PARA BARRA ESTABILIZADORA	DAI-1416019

ALTIMA

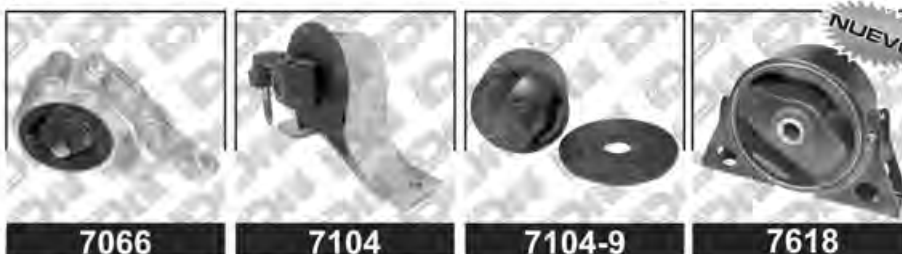
SOPORTES / TRANSMISSION & MOTOR MOUNTS			
L4 2.4	93-01	SOPORTE PARA TRANSMISIÓN	7065
		SOPORTE PARA MOTOR DERECHO	7066
		SOPORTE PARA MOTOR FRONTAL	7618
L4 2.5	02-06	SOPORTE PARA TRANSMISIÓN	7032
		SOPORTE PARA MOTOR DERECHO	7104
		REPUESTO PARA SOPORTE DE MOTOR DERECHO (7104 Y 7247)	7104-9



CONTINUACIÓN... ALTIMA

 		APLICACIÓN / DESCRIPTION	DAI PARTS #
SOPORTES / TRANSMISSION & MOTOR MOUNTS			
L4 2.5	02-06	SOPORTE PARA MOTOR FRONTAL	7141
		REPUESTO PARA SOPORTE DE MOTOR FRONTAL (7141)	7141-9
		REPUESTO PARA SOPORTE DE MOTOR FRONTAL Y TRASERO	7019-9
		SOPORTE PARA MOTOR TRASERO	7644
	07-12	REPUESTO PARA SOPORTE DE MOTOR TRASERO (7644)	7644-9
		SOPORTE DE TORSIÓN DERECHO SUPERIOR	7458
	07-15	SOPORTE PARA TRANSMISIÓN (CVT)	7516-H
		SOPORTE PARA MOTOR DERECHO	7517-H
07-16	SOPORTE DE TORSIÓN DERECHO SUPERIOR	7604	
V6 3.5	07-16	SOPORTE PARA MOTOR TRASERO TORQUE STRUT	7658
	00-06	REPUESTO SOPORTE PARA MOTOR FRONTAL Y TRASERO	7160-9
		SOPORTE PARA TRANSMISIÓN	7032
		SOPORTE PARA MOTOR DERECHO	7247
		SOPORTE PARA MOTOR FRONTAL	7266-EL
02-06	SOPORTE PARA MOTOR TRASERO (SOLIDO SIN ACTUADOR)	7267	

SOPORTES TRANSMISSION & MOTOR MOUNTS



7019-9 7032

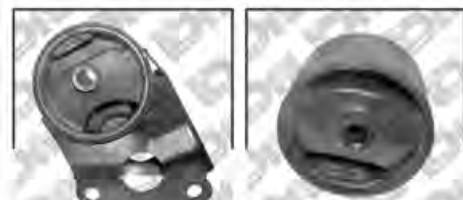

7141 7141-9



7160-9 7247



7266-EL 7267



7458 7516-H 7517-H 7604







7644 7644-9 7658



CONTINUACIÓN... ALTIMA

 28		APLICACIÓN / DESCRIPTION	DAI PARTS #	SOPORTES TRANSMISIÓN & MOTOR MOUNTS	
SOPORTES / TRANSMISIÓN & MOTOR MOUNTS					
V6 3.5	02-06	SOPORTE PARA MOTOR TRASERO	7267-EL		
		SOPORTE PARA TRANSMISIÓN AUT.	7395		
	07-13	SOPORTE DE TORSIÓN DERECHO SUPERIOR	7458		
		SOPORTE PARA TRANSMISIÓN STD., AUT. Y CVT	7552		
		SOPORTE PARA MOTOR DERECHO	7561-H		
	07-16	SOPORTE PARA MOTOR FRONTAL	7671		
		SOPORTE PARA MOTOR TRASERO	7672		
		SOPORTE PARA MOTOR TRASERO TORQUE STRUT	7699		
	13-16	SOPORTE PARA TRANSMISIÓN	7711		



 28		APLICACIÓN / DESCRIPTION	DAI PARTS #	DAI KIT PARTS #	BASES PARA AMORTIGUADOR STRUT MOUNTS	
BASES PARA AMORTIGUADOR / STRUT MOUNTS						
93-97	BASE PARA AMORTIGUADOR FRONTAL IZQUIERDA Y DERECHA		6743	6743-KIT		
	BASE PARA AMORTIGUADOR TRASERA IZQUIERDA Y DERECHA			7291-KIT		
02-06	BASE PARA AMORTIGUADOR FRONTAL IZQUIERDA Y DERECHA			7300-KIT		



CONTINUACIÓN... ALTIMA

28	APLICACIÓN / DESCRIPTION	DAI PARTS #	DAI KIT PARTS #
BASES PARA AMORTIGUADOR / STRUT MOUNTS			
02-06	BASE PARA AMORTIGUADOR TRASERA IZQUIERDA Y DERECHA		7637-KIT
02-09	BASE PARA AMORTIGUADOR TRASERA IZQUIERDA Y DERECHA		7352-KIT



28	APLICACIÓN / DESCRIPTION	DAI PARTS #
CUBRE POLVOS / C.V. BOOTS		
02-06	CUBRE POLVO IZQUIERDO Y DERECHO LADO RUEDA	6309
	CUBRE POLVO IZQUIERDO Y DERECHO LADO CAJA	6351
	CUBRE POLVO IZQUIERDO Y DERECHO LADO RUEDA	6359
07-12	CUBRE POLVO IZQUIERDO Y DERECHO LADO CAJA (CON TRIPOIDE)	63174
07-13	CUBRE POLVO IZQUIERDO Y DERECHO LADO RUEDA	63173
	CUBRE POLVO IZQUIERDO Y DERECHO LADO RUEDA	63191
	CUBRE POLVO IZQUIERDO Y DERECHO DE DIRECCIÓN	63192
09-11	CUBRE POLVO IZQUIERDO Y DERECHO LADO CAJA (CON TRIPOIDE)	63176
09-14	CUBRE POLVO DERECHO DE DIRECCIÓN	63177
	CUBRE POLVO IZQUIERDO DE DIRECCIÓN	63178



CONTINUACIÓN... ALTIMA

 		APLICACIÓN / DESCRIPTION	DAI PARTS #	MISCELÁNEOS / AUTOMOTIVE RUBBER PARTS	
93-01		TOPE PARA AMORTIGUADOR FRONTAL IZQUIERDO Y DERECHO	D-0619		
		BUJE PARA HORQUILLA CHICO	DAI-54590-01E00	D-0619	D-0620
		BUJE PARA HORQUILLA INFERIOR GRANDE	DAI-54570-0E010		
		TORNILLO ESTABILIZADOR FRONTAL	DAI-54618-0Z800	64705	64711
93-97		TOPE PARA AMORTIGUADOR TRASERO IZQUIERDO Y DERECHO	D-0620		
02-06		GOMA PARA BARRA ESTABILIZADORA	64711		
		BUJE PARA HORQUILLA INFERIOR GRANDE (SIN SOPORTE)	DAI-1416059		
05-09		GOMA PARA BARRA ESTABILIZADORA	64705		

DAI-1416059

DAI-54570-0E010

DAI-54590-01E00

DAI-54618-0Z800
APRIO

SOPORTES / TRANSMISSION & MOTOR MOUNTS				SOPORTES TRANSMISSION & MOTOR MOUNTS	
L4 1.6	07-11	SOPORTE PARA MOTOR TRASERO	7196		
		SOPORTE PARA MOTOR DERECHO	7444	7196	7444
		SOPORTE PARA TRANSMISIÓN	7445		

7445

CONTINUACIÓN... APRIO

28		APLICACIÓN / DESCRIPTION	DAI PARTS #	DAI KIT PARTS #
BASES PARA AMORTIGUADOR / STRUT MOUNTS				
07-11		BASE PARA AMORTIGUADOR FRONTAL IZQUIERDA Y DERECHA		7443-KIT
		BALERO PARA BASE DE AMORTIGUADOR 7443-KIT	6147	



28		APLICACIÓN / DESCRIPTION	DAI PARTS #
CUBRE POLVOS / C.V. BOOTS			
	07-11	CUBRE POLVO IZQUIERDO Y DERECHO LADO RUEDA	63167
		CUBRE POLVO IZQUIERDO Y DERECHO LADO CAJA (CON TRIPOIDE)	63168



ARMADA

SOPORTES / TRANSMISSION & MOTOR MOUNTS			
V8 5.6	04-10	SOPORTE PARA TRANSMISIÓN (4X4)	7274
		SOPORTE PARA MOTOR IZQUIERDO Y DERECHO	7275
		SOPORTE PARA TRANSMISIÓN (4X2)	7324



CAMIONETAS



 		APLICACIÓN / DESCRIPTION	DAI PARTS #
MISCELÁNEOS / AUTOMOTIVE RUBBER PARTS			
		CONJUNTO DE GOMAS DELANTERAS PARA CASETA	105
		CONJUNTO DE GOMAS TRASERAS PARA CASETA	106
71-93		GOMAS PARA BRAZO AUXILIAR	64380
78-96		BUJE PARA HORQUILLA SUPERIOR	64440
		BUJE PARA MUELLE (POLIURETANO)	9136
79-84		GOMA PARA BARRA DE TORSIÓN	6057
		GOMA PARA TIRANTE DE SUSPENSIÓN	6053
81-92		GOMA PARA BARRA ESTABILIZADORA	74

CUBE

SOPORTES / TRANSMISSION & MOTOR MOUNTS			
L4 1.8	09-14	SOPORTE PARA MOTOR TRASERO	7196
		SOPORTE PARA TRANSMISIÓN STD. Y AUT.	7197
		SOPORTE PARA MOTOR DERECHO SUPERIOR TORQUE STRUT	7203
		SOPORTE PARA MOTOR DERECHO	7399-H



CONTINUACIÓN... CUBE

  28		APLICACIÓN / DESCRIPTION	DAI PARTS #
MISCELÁNEOS / AUTOMOTIVE RUBBER PARTS			
09-14		BUJES PARA HORQUILLA (POLIURETANO KIT)	9807
		BUJE PARA HORQUILLA INFERIOR CHICO	DAI-1416007
		BUJE PARA HORQUILLA INFERIOR GRANDE	DAI-1416009
		TORNILLO ESTABILIZADOR FRONTAL	DAI-2116019

**MISCELÁNEOS
AUTOMOTIVE RUBBER PARTS**



9807



DAI-1416007



DAI-1416009



DAI-2116019

D-21

SOPORTES / TRANSMISSION & MOTOR MOUNTS			
L4 1800	84-93	SOPORTE PARA MOTOR IZQUIERDO Y DERECHO	1824
		SOPORTE PARA TRANSMISIÓN	1800
L4 2.4	93-08	SOPORTE PARA MOTOR IZQUIERDO Y DERECHO	6676
	94-08	SOPORTE PARA TRANSMISIÓN <i>(PICK UP USA)</i>	6677
V6 3.0	86-96	SOPORTE PARA TRANSMISIÓN <i>(PICK UP USA)</i>	6677
		SOPORTE PARA MOTOR IZQUIERDO Y DERECHO	7743

**SOPORTES
TRANSMISSION & MOTOR MOUNTS**



1800



1824



6676



6677



7743



CONTINUACIÓN... D-21

		APLICACIÓN / DESCRIPTION	DAI PARTS #	MISCELÁNEOS / AUTOMOTIVE RUBBER PARTS	
MISCELÁNEOS / AUTOMOTIVE RUBBER PARTS				MISCELÁNEOS AUTOMOTIVE RUBBER PARTS	
79-93		GOMAS PARA TIRANTE DE SUSPENSIÓN	6053		
		BUJE PARA MUELLE (POLIURETANO)	9160		
		BUJE TENSOR (TIPO YOYO POLIURETANO)	9170		
		GOMA PARA BARRA TENSORA	64410		
79-08		BUJE INFERIOR (4X2)	DAI-54423-B9500		
		COPELE PARA DIRECCIÓN DOBLE (SINFÍN DE .650" 2 PERNOS DELGADOS REPUESTO 642)	610		
		COPELE PARA DIRECCIÓN SENCILLO (SINFÍN DE .570" 2 PERNOS UNIVERSALES)	614		
79-08		GALLETAS PARA DIRECCIÓN STD. Y HID. (2 PERNOS DELGADOS COMPLETO 610)	642		
		GOMA PARA BARRA ESTABILIZADORA	6062		
		GOMA PARA AMORTIGUADOR (POLIURETANO)	9163		
81-08		BUJE PARA MUELLE TRASERO (POLIURETANO 3/4")	9191		
		BUJE PARA MUELLE TRASERO (POLIURETANO 9/16")	9084		
		BUJE PARA MUELLE TRASERO (POLIURETANO ASTRIADO CHICO 1 1/8" X 9/16" X 1 5/8")	9085		
		9122			
9160 9163 9170 9191					
				64410	DAI-54423-B9500



CONTINUACIÓN... D-21

 		APLICACIÓN / DESCRIPTION	DAI PARTS #
MISCELÁNEOS / AUTOMOTIVE RUBBER PARTS			
81-08		BUJE PARA MUELLE TRASERO (POLIURETANO ASTRIADO CHICO 1 3/4" X 5/8" X 1 9/16")	9123
		BUJE PARA MUELLE (POLIURETANO DIAM. INT. 5/8" DIAM. EXT. 1 5/8" LARGO 1 1/2")	9124
		BUJE PARA MUELLE (POLIURETANO TRASERO DELGADO)	9132
81-92		GOMA PARA BARRA ESTABILIZADORA	74
81-93		BUJE PARA MUELLE (POLIURETANO 9/16" 4 1/64" X 1 17/32")	9154
		BUJE PARA MUELLE (POLIURETANO 3/4" 1 4 1/64" X 25/32" X 1 17/32")	9155
94-08		GOMA PARA BARRA ESTABILIZADORA	64702
		GOMA PARA BARRA ESTABILIZADORA (4X4)	64713

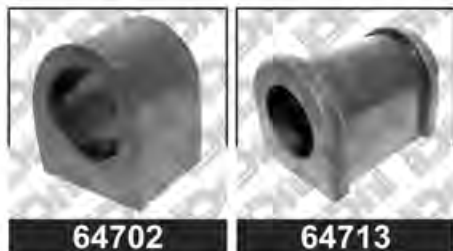
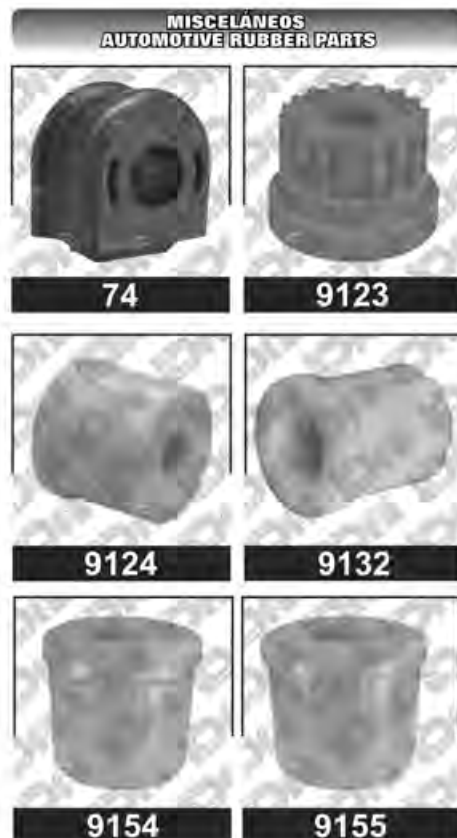

D-22

SOPORTES / TRANSMISSION & MOTOR MOUNTS			
L4 2.4	09-15	SOPORTE PARA MOTOR IZQUIERDO Y DERECHO <i>NP-300</i>	7354
		SOPORTE PARA TRANSMISIÓN IZQUIERDO Y DERECHO <i>NP-300 DIESEL</i>	7420
		SOPORTE PARA MOTOR DERECHO (<i>NP-300 DIESEL</i>)	7494
		SOPORTE PARA MOTOR IZQUIERDO (<i>NP-300 DIESEL</i>)	7571



DATSUN

 28		APLICACIÓN / DESCRIPTION	DAI PARTS #
SOPORTES / TRANSMISSION & MOTOR MOUNTS			
L4 1500 1600 1800	70-86	SOPORTE PARA TRANSMISIÓN STD.	1786
		SOPORTE PARA MOTOR DERECHO	1794
		SOPORTE PARA MOTOR IZQUIERDO	1803

1803

MISCELÁNEOS / AUTOMOTIVE RUBBER PARTS			
	58-84	TOPE PARA AMORTIGUADOR FRONTAL IZQUIERDO Y DERECHO	D-0620

DATSUN SEDAN

SOPORTES / TRANSMISSION & MOTOR MOUNTS			
L4 1500 1600 1800	68-84	SOPORTE PARA MOTOR IZQUIERDO	1716
		SOPORTE PARA MOTOR DERECHO	1717



CONTINUACIÓN... DATSUN SEDAN

 		APLICACIÓN / DESCRIPTION	DAI PARTS #
SOPORTES / TRANSMISSION & MOTOR MOUNTS			
L4 1500 1600 1800	68-84	SOPORTE PARA MOTOR IZQUIERDO Y DERECHO	1785
		SOPORTE PARA TRANSMISIÓN STD.	1802
		SOPORTE PARA MOTOR IZQUIERDO Y DERECHO	1834

**SOPORTES
TRANSMISSION & MOTOR MOUNTS**



1785



1802



1834

MISCELÁNEOS / AUTOMOTIVE RUBBER PARTS		
68-84	TOPE PARA AMORTIGUADOR FRONTAL IZQUIERDO Y DERECHO	D-0620

**MISCELÁNEOS
AUTOMOTIVE RUBBER PARTS**



D-0620

FRONTIER

SOPORTES / TRANSMISSION & MOTOR MOUNTS			
L4 2.4	98-04	SOPORTE PARA TRANSMISIÓN	7421
		SOPORTE PARA MOTOR IZQUIERDO Y DERECHO	7547

**SOPORTES
TRANSMISSION & MOTOR MOUNTS**



7421



7547

NUEVO



CONTINUACIÓN... FRONTIER

 		APLICACIÓN / DESCRIPTION	DAI PARTS #
SOPORTES / TRANSMISSION & MOTOR MOUNTS			
L4 2.4	98-04	SOPORTE PARA MOTOR IZQUIERDO Y DERECHO	7688
		SOPORTE PARA TRANSMISIÓN	7645
	98-05	SOPORTE PARA MOTOR IZQUIERDO Y DERECHO	6676
		SOPORTE PARA MOTOR IZQUIERDO Y DERECHO	7354
	2008	SOPORTE PARA TRANSMISIÓN (4X2)	6677
L4 2.5	05-16	SOPORTE PARA MOTOR IZQUIERDO Y DERECHO	7646
		SOPORTE PARA TRANSMISIÓN	7736
V6 3.3	98-04	SOPORTE PARA TRANSMISIÓN	7645
V6 4.0	05-16	SOPORTE PARA TRANSMISIÓN	7736

**SOPORTES
TRANSMISSION & MOTOR MOUNTS**

6676

6677

7354

7645



7646
7688
7736

		APLICACIÓN / DESCRIPTION	DAI PARTS #	DAI KIT PARTS #
BASES PARA AMORTIGUADOR / STRUT MOUNTS				
05-16		BASE PARA AMORTIGUADOR FRONTAL IZQUIERDA Y DERECHA		7634-KIT

**BASES PARA AMORTIGUADOR
STRUT MOUNTS**

7634-KIT

CONTINUACIÓN... FRONTIER

 		APLICACIÓN / DESCRIPTION	DAI PARTS #
MISCELÁNEOS / AUTOMOTIVE RUBBER PARTS			
	98-04	TORNILLO ESTABILIZADOR TRASERO (4X2 Y 4X4 BRASIL)	DAI-2116028
	98-05	GOMA PARA BARRA ESTABILIZADORA (4X2)	64702



GSR

SOPORTES / TRANSMISSION & MOTOR MOUNTS			
L4 2.0	94-00	SOPORTE PARA TRANSMISIÓN	6685
		SOPORTE PARA MOTOR DERECHO	6686
		SOPORTE PARA MOTOR TRASERO	6694
		SOPORTE PARA MOTOR DERECHO	6801
		SOPORTE PARA MOTOR DERECHO	6802
		SOPORTE PARA TRANSMISIÓN	6804
		SOPORTE PARA MOTOR TRASERO	6807



CUBRE POLVOS / C.V. BOOTS			
	94-00	CUBRE POLVO IZQUIERDO DE DIRECCION STD.	6335
		CUBRE POLVO DERECHO DE DIRECCIÓN STD.	6336





635

IMPORTANTE: Identifica nuestro producto con el grabado del logo  No aceptes imitaciones.



CONTINUACIÓN... GSR

 		APLICACIÓN / DESCRIPTION	DAI PARTS #
CUBRE POLVOS / C.V. BOOTS			
94-00		CUBRE POLVO IZQUIERDO Y DERECHO DE DIRECCIÓN HID.	6345
		CUBRE POLVO IZQUIERDO Y DERECHO LADO RUEDA	6360
		CUBRE POLVO IZQUIERDO Y DERECHO DE DIRECCIÓN HID.	6376
		CUBRE POLVO IZQUIERDO Y DERECHO LADO CAJA	6390
		CUBRE POLVO IZQUIERDO Y DERECHO LADO RUEDA	6392

CUBRE POLVO C.V. BOOTS



6345



6360



6376



6390



6392

HIKARI

CUBRE POLVOS / C.V. BOOTS		
88-92	CUBRE POLVO IZQUIERDO Y DERECHO LADO RUEDA	6360

CUBRE POLVO C.V. BOOTS



6360



ICHI-VAN

 		APLICACIÓN / DESCRIPTION	DAI PARTS #
SOPORTES / TRANSMISSION & MOTOR MOUNTS			
L4 1800	87-94	SOPORTE PARA MOTOR IZQUIERDO Y DERECHO	1841
		SOPORTE PARA TRANSMISIÓN	1842
		SOPORTE PARA MOTOR FRONTAL DERECHO	1843
		SOPORTE PARA MOTOR FRONTAL IZQUIERDO	1844



MISCELÁNEOS / AUTOMOTIVE RUBBER PARTS			
	87-94	TOPE PARA SUSPENSIÓN DELANTERA (DAIM. 55 mm ALT. 117 mm)	379
		TORNILLO ESTABILIZADOR (5", 154.2400 mm)	6100
		TORNILLO ESTABILIZADOR (5", 154.2400 mm EQUIPO ORIGINAL)	6104
		BUJE PARA MUELLE (POLIURETANO 9/16" 4 1/64" X 1 17/32")	9154
		BUJE PARA MUELLE (POLIURETANO 3/4" 1 4 1/64" X 25/32" X 1 17/32")	9155
		BUJE PARA HORQUILLA SUPERIOR	64710

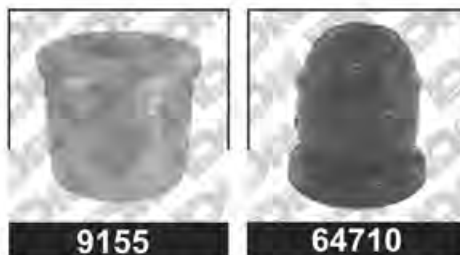



JUKE

 		APLICACIÓN / DESCRIPTION	DAI PARTS #
SOPORTES / TRANSMISSION & MOTOR MOUNTS			
L4 1.6	11-17	SOPORTE PARA TRANSMISIÓN	7441
		SOPORTE PARA MOTOR TRASERO 4X4	7493
		SOPORTE PARA MOTOR DERECHO INFERIOR	7659-H

7659-H

		APLICACIÓN / DESCRIPTION	DAI PARTS #	DAI KIT PARTS #
BASES PARA AMORTIGUADOR / STRUT MOUNTS				
11-17		BASE PARA AMORTIGUADOR FRONTAL DERECHA	7357	7357-KIT
		BASE PARA AMORTIGUADOR FRONTAL IZQUIERDA	7394	7394-KIT
		BALERO PARA BASE DE AMORTIGUADOR FRONTAL IZQUIERDA Y DERECHA (7357, 7394, 7410-KIT Y 7411-KIT)	6149	



 		APLICACIÓN / DESCRIPTION	DAI PARTS #
CUBRE POLVOS / C.V. BOOTS			
11-17		CUBRE POLVO IZQUIERDO Y DERECHO LADO RUEDA	63181
		CUBRE POLVO IZQUIERDO DE DIRECCIÓN	63182



CONTINUACIÓN... JUKE

		APLICACIÓN / DESCRIPTION	DAI PARTS #
CUBRE POLVOS / C.V. BOOTS			
	11-17	CUBRE POLVO IZQUIERDO Y DERECHO LADO CAJA (CON TRIPOIDE)	63183



LUCINO

SOPORTES / TRANSMISSION & MOTOR MOUNTS			
L4 2.0	96-00	SOPORTE PARA MOTOR DERECHO	6801
		SOPORTE PARA TRANSMISIÓN	6804
		SOPORTE PARA MOTOR TRASERO	6807



		APLICACIÓN / DESCRIPTION	DAI PARTS #	DAI KIT PARTS #
BASES PARA AMORTIGUADOR / STRUT MOUNTS				
96-00	REPUESTO BASE DE AMORTIGUADOR FRONTAL IZQUIERDA Y DERECHA	6716	6716-KIT	
	BASE PARA AMORTIGUADOR FRONTAL IZQUIERDA Y DERECHA	6717	6717-KIT	



CONTINUACIÓN... LUCINO

28	APLICACIÓN / DESCRIPTION	DAI PARTS #	DAI KIT PARTS #
BASES PARA AMORTIGUADOR / STRUT MOUNTS			
96-00	BALERO PARA BASES DE AMORTIGUADOR 6716-KIT, 7026, 7298-KIT, 7300-KIT Y 6717-KIT	6142	

**BASES PARA AMORTIGUADOR
STRUT MOUNTS**

6142

28	APLICACIÓN / DESCRIPTION	DAI PARTS #
CUBRE POLVOS / C.V. BOOTS		
96-00	CUBRE POLVO IZQUIERDO DE DIRECCIÓN STD.	6335
	CUBRE POLVO DERECHO DE DIRECCIÓN STD.	6336
	CUBRE POLVO IZQUIERDO Y DERECHO DE DIRECCIÓN HID.	6345
	CUBRE POLVO IZQUIERDO Y DERECHO LADO RUEDA	6360
	CUBRE POLVO IZQUIERDO Y DERECHO DE DIRECCIÓN HID.	6376
	CUBRE POLVO IZQUIERDO Y DERECHO LADO CAJA	6390
	CUBRE POLVO IZQUIERDO Y DERECHO LADO RUEDA	6392

**CUBRE POLVOS
C.V. BOOTS**

6335

6336

6345

6360

6376

6390

6392

CONTINUACIÓN... LUCINO

  28		APLICACIÓN / DESCRIPTION	DAI PARTS #
MISCELÁNEOS / AUTOMOTIVE RUBBER PARTS			
96-00		TOPE PARA AMORTIGUADOR FRONTAL IZQUIERDO Y DERECHO	D-0619
		TOPE PARA AMORTIGUADOR TRASERO IZQUIERDO Y DERECHO (HULE)	2002
		TORNILLO ESTABILIZADOR FRONTAL	64620
		BUJE PARA HORQUILLA TRASERA	64670



MARCH

SOPORTES / TRANSMISSION & MOTOR MOUNTS			
L4 1.6	11-17	SOPORTE PARA TRANSMISIÓN	7406
		SOPORTE PARA MOTOR TRASERO	7407
		SOPORTE PARA MOTOR DERECHO	7643-H



CONTINUACIÓN... MARCH

28	APLICACIÓN / DESCRIPTION	DAI PARTS #	DAI KIT PARTS #
BASES PARA AMORTIGUADOR / STRUT MOUNTS			
11-17	BASE PARA AMORTIGUADOR FRONTAL IZQUIERDA Y DERECHA		7408-KIT

**BASES PARA AMORTIGUADOR
STRUT MOUNTS**

7408-KIT

28	APLICACIÓN / DESCRIPTION	DAI PARTS #
CUBRE POLVOS / C.V. BOOTS		
11-17	CUBRE POLVO IZQUIERDO Y DERECHO LADO RUEDA	63144
	CUBRE POLVO IZQUIERDO Y DERECHO LADO CAJA (CON TRIPOIDE)	63150
	CUBRE POLVO IZQUIERDO Y DERECHO DE DIRECCIÓN	63151

**CUBRE POLVOS
C.V. BOOTS**

63144

63150

63150

63151
MISCELÁNEOS / AUTOMOTIVE RUBBER PARTS

11-17	BUJE PARA HORQUILLA CHICO	DAI-1416042
	BUJE PARA HORQUILLA GRANDE	DAI-1416043
	TORNILLO ESTABILIZADOR FRONTAL	DAI-2116019



**MISCELÁNEOS
AUTOMOTIVE RUBBER PARTS**

DAI-1416042

DAI-1416043

DAI-2116019

MAXIMA

 		APLICACIÓN / DESCRIPTION	DAI PARTS #
SOPORTES / TRANSMISSION & MOTOR MOUNTS			
V6 3.0	95-01	SOPORTE PARA MOTOR DERECHO	7265
		REPUESTO PARA SOPORTES DE MOTOR Y TRANSMISIÓN (7032, 7040 Y 7265)	7217-9
		SOPORTE PARA MOTOR FRONTAL	7477
		SOPORTE PARA MOTOR TRASERO	7538
V6 3.5	00-08	SOPORTE PARA MOTOR FRONTAL	7266-EL
	02-03	REPUESTO PARA SOPORTES DE MOTOR Y TRANSMISIÓN (7032, 7040 Y 7265)	7217-9
		SOPORTE PARA MOTOR TRASERO	7538
	02-08	SOPORTE PARA MOTOR DERECHO	7265
		SOPORTE PARA MOTOR TRASERO (SOLIDO SIN ACTUADOR)	7267
		SOPORTE PARA MOTOR TRASERO	7267-EL
	04-08	SOPORTE PARA MOTOR DERECHO	7247
	07-16	SOPORTE PARA MOTOR FRONTAL	7671
	09-11	SOPORTE PARA TRANSMISIÓN AUT.	7395
		SOPORTE PARA TRANSMISIÓN STD., AUT. Y CVT	7552
	09-12	SOPORTE PARA MOTOR DERECHO	7561-H
	09-14	SOPORTE PARA MOTOR TRASERO	7672
		SOPORTE PARA MOTOR TRASERO TORQUE STRUT	7699



CONTINUACIÓN... MAXIMA

28	APLICACIÓN / DESCRIPTION	DAI PARTS #	DAI KIT PARTS #
BASES PARA AMORTIGUADOR / STRUT MOUNTS			
85-94	BASE PARA AMORTIGUADOR FRONTAL IZQUIERDA Y DERECHA		7221-KIT
	BASE PARA AMORTIGUADOR TRASERA DERECHA		7297-KIT
95-99	BASE PARA AMORTIGUADOR TRASERA IZQUIERDA Y DERECHA		7291-KIT
	BASE PARA AMORTIGUADOR FRONTAL IZQUIERDA Y DERECHA		7298-KIT
00-03	BASE PARA AMORTIGUADOR TRASERA IZQUIERDA Y DERECHA		7637-KIT
00-08	BASE PARA AMORTIGUADOR FRONTAL IZQUIERDA Y DERECHA		7300-KIT



28	APLICACIÓN / DESCRIPTION	DAI PARTS #
CUBRE POLVOS / C.V. BOOTS		
09-11	CUBRE POLVO IZQUIERDO Y DERECHO LADO CAJA (CON TRIPOIDE)	63176
	CUBRE POLVO DERECHO DE DIRECCIÓN	63177
09-14	CUBRE POLVO IZQUIERDO DE DIRECCIÓN	63178



CONTINUACIÓN... MAXIMA

 	APLICACIÓN / DESCRIPTION	DAI PARTS #
MISCELÁNEOS / AUTOMOTIVE RUBBER PARTS		
85-88	TOPE PARA AMORTIGUADOR FRONTAL IZQUIERDO Y DERECHO	D-0622
86-88	TOPE PARA AMORTIGUADOR FRONTAL Y TRASERO IZQUIERDO Y DERECHO	D-0621
85-94	TOPE PARA AMORTIGUADOR TRASERO IZQUIERDO Y DERECHO	D-0619
	TOPE PARA AMORTIGUADOR FRONTAL IZQUIERDO Y DERECHO	D-0620
	BUJE PARA HORQUILLA INFERIOR GRANDE	DAI-54570-0E010
85-03	BUJE PARA HORQUILLA CHICO	DAI-54590-01E00
95-99	TORNILLO ESTABILIZADOR FRONTAL	DAI-54618-0Z800
00-03	GOMA PARA BARRA ESTABILIZADORA	64711
	TORNILLO ESTABILIZADOR FRONTAL IZQUIERDO	DAI-2116005
	TORNILLO ESTABILIZADOR FRONTAL DERECHO	DAI-2116004
00-08	GOMA PARA BARRA ESTABILIZADORA	64705
04-08	BUJE PARA HORQUILLA INFERIOR GRANDE (SIN SOPORTE)	DAI-1416059

**MISCELÁNEOS
AUTOMOTIVE RUBBER PARTS**

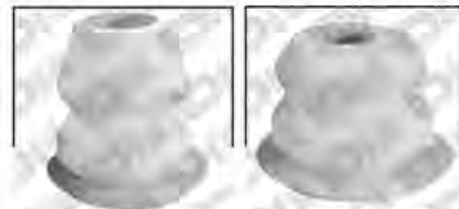

D-0619

D-0620

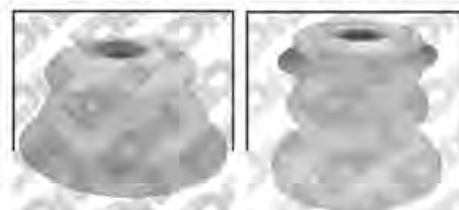

D-0621

D-0622



64705

64711



DAI-1416059

DAI-2116004



DAI-2116005



DAI-54570-0E010



DAI-54590-01E00



DAI-54618-0Z800





MICRA

 		APLICACIÓN / DESCRIPTION	DAI PARTS #
SOPORTES / TRANSMISSION & MOTOR MOUNTS			
L4 1.4	05-08	SOPORTE PARA MOTOR DERECHO	7162-H
		SOPORTE PARA MOTOR TRASERO	7196
		SOPORTE PARA TRANSMISIÓN	7445

7162-H

 		APLICACIÓN / DESCRIPTION	DAI PARTS #	DAI KIT PARTS #
BASES PARA AMORTIGUADOR / STRUT MOUNTS				
05-08	BASE PARA AMORTIGUADOR FRONTAL DERECHA (EUROPA)	7357	7357-KIT	
	BALERO PARA BASE DE AMORTIGUADOR FRONTAL IZQUIERDA Y DERECHA (7357, 7394, 7410-KIT Y 7411-KIT)	6149		
	BASE PARA AMORTIGUADOR FRONTAL IZQUIERDA	7394	7394-KIT	



 		APLICACIÓN / DESCRIPTION	DAI PARTS #
MISCELÁNEOS / AUTOMOTIVE RUBBER PARTS			
05-08	BUJES PARA HORQUILLA (POLIURETANO KIT)	9807	
	BUJE PARA HORQUILLA INFERIOR CHICO	DAI-1416007	



CONTINUACIÓN... MICRA

	 28	APLICACIÓN / DESCRIPTION	DAI PARTS #
MISCELÁNEOS / AUTOMOTIVE RUBBER PARTS			
	05-08	BUJE PARA HORQUILLA INFERIOR GRANDE	DAI-1416009

**MISCELÁNEOS
AUTOMOTIVE RUBBER PARTS**



DAI-1416009

MURANO

SOPORTES / TRANSMISSION & MOTOR MOUNTS			
V6 3.5	02-07	SOPORTE PARA MOTOR TRASERO (SOLIDO SIN ACTUADOR)	7267
	03-10	SOPORTE PARA TRANSMISIÓN	7032
		SOPORTE PARA MOTOR DERECHO	7247
		SOPORTE PARA TRANSMISIÓN AUT.	7395
	04-08	REPUESTO PARA SOPORTE DE MOTOR DERECHO (7104 Y 7247)	7104-9
		SOPORTE PARA MOTOR FRONTAL	7266-EL
	09-14	SOPORTE PARA MOTOR TRASERO	7267-EL
	15-16	SOPORTE PARA MOTOR FRONTAL	7671

**SOPORTES
TRANSMISSION & MOTOR MOUNTS**



7032



7104-9



7247



7266-EL



7267



7267-EL



7395



7671



7699



CONTINUACIÓN... MURANO

28		APLICACIÓN / DESCRIPTION	DAI PARTS #	DAI KIT PARTS #
BASES PARA AMORTIGUADOR / STRUT MOUNTS				
03-08		BASE PARA AMORTIGUADOR FRONTAL IZQUIERDA Y DERECHA		7300-KIT
		BASE PARA AMORTIGUADOR TRASERA IZQUIERDA Y DERECHA		7637-KIT



28		APLICACIÓN / DESCRIPTION	DAI PARTS #
CUBRE POLVOS / C.V. BOOTS			
09-14		CUBRE POLVO IZQUIERDO Y DERECHO LADO RUEDA	63179
		CUBRE POLVO IZQUIERDO Y DRECHO LADO CAJA (CON TRIPOIDE)	63180



MISCELÁNEOS / AUTOMOTIVE RUBBER PARTS			
03-08		TORNILLO ESTABILIZADOR FRONTAL DERECHO	DAI-2116012
		TORNILLO ESTABILIZADOR FRONTAL IZQUIERDO	DAI-2116013

NOTE

SOPORTES / TRANSMISSION & MOTOR MOUNTS			
L4 1.6	14-17	SOPORTE PARA TRANSMISIÓN	7406
		SOPORTE PARA MOTOR TRASERO	7407
		SOPORTE PARA MOTOR DERECHO	7643-H



CONTINUACIÓN... NOTE

28	APLICACIÓN / DESCRIPTION	DAI PARTS #	DAI KIT PARTS #
BASES PARA AMORTIGUADOR / STRUT MOUNTS			
14-17	BASE PARA AMORTIGUADOR FRONTAL IZQUIERDA Y DERECHA		7408-KIT



28	APLICACIÓN / DESCRIPTION	DAI PARTS #
CUBRE POLVOS / C.V. BOOTS		
14-17	CUBRE POLVO IZQUIERDO Y DERECHO LADO RUEDA	63144
	CUBRE POLVO IZQUIERDO Y DERECHO LADO CAJA (CON TRIPOIDE)	63145
	CUBRE POLVO IZQUIERDO Y DERECHO DE DIRECCIÓN	63146



MISCELÁNEOS / AUTOMOTIVE RUBBER PARTS			
14-17	TORNILLO ESTABILIZADOR FRONTAL	DAI-2116019	
	BUJE PARA HORQUILLA CHICO	DAI-1416042	
	BUJE PARA HORQUILLA GRANDE	DAI-1416043	



NV-2500

 		APLICACIÓN / DESCRIPTION	DAI PARTS #
SOPORTES / TRANSMISSION & MOTOR MOUNTS			
V8 5.6	12-15	SOPORTE PARA TRANSMISIÓN	7274
		SOPORTE PARA MOTOR IZQUIERDO Y DERECHO	7275

NV-3500

SOPORTES / TRANSMISSION & MOTOR MOUNTS			
V8 5.6	12-15	SOPORTE PARA TRANSMISIÓN	7274
		SOPORTE PARA MOTOR IZQUIERDO Y DERECHO	7275

NX

SOPORTES / TRANSMISSION & MOTOR MOUNTS			
L4 1.6	91-93	SOPORTE PARA MOTOR DERECHO	6970
		REPUESTO PARA SOPORTE DE MOTOR DERECHO (6970)	6970-9
L4 1.6 L4 2.0	91-93	SOPORTE PARA MOTOR FRONTAL STD.	6684
		REPUESTO PARA SOPORTE DE MOTOR FRONTAL STD. (6684)	6689

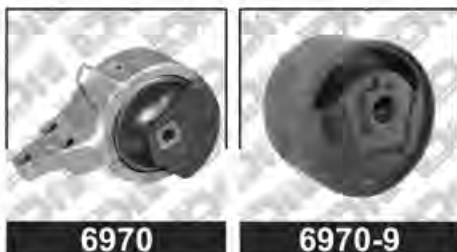

CONTINUACIÓN... NX

  28		APLICACIÓN / DESCRIPTION	DAI PARTS #
SOPORTES / TRANSMISSION & MOTOR MOUNTS			
L4 1.6 L4 2.0	91-93	SOPORTE PARA TRANSMISIÓN	6685
		SOPORTE PARA MOTOR DERECHO	6686
		SOPORTE PARA MOTOR DERECHO	6802
		REPUESTO PARA SOPORTE DE MOTOR IZQUIERDO Y DERECHO (6686, 6802, 6685 Y 6854)	1941



PATHFINDER

SOPORTES / TRANSMISSION & MOTOR MOUNTS			
L4 2.4	87-89	SOPORTE PARA TRANSMISIÓN	6998
		SOPORTE PARA MOTOR IZQUIERDO Y DERECHO	7354
	1987	SOPORTE PARA MOTOR IZQUIERDO Y DERECHO	7547
V6 3.0	87-95	SOPORTE PARA TRANSMISIÓN (TRACCIÓN TRASERA)	6677
		SOPORTE PARA MOTOR IZQUIERDO Y DERECHO	7743





CONTINUACIÓN... PATHFINDER

 		APLICACIÓN / DESCRIPTION	DAI PARTS #
SOPORTES / TRANSMISSION & MOTOR MOUNTS			
V6 3.5	13-15	SOPORTE PARA MOTOR TRASERO	7699
	13-16	SOPORTE PARA MOTOR FRONTAL	7671
V6 4.0	05-12	SOPORTE PARA TRANSMISIÓN	7736
V8 5.6	04-11	SOPORTE PARA TRANSMISIÓN (4X4)	7274
		SOPORTE PARA MOTOR IZQUIERDO Y DERECHO	7275
		SOPORTE PARA TRANSMISIÓN (4X2)	7324



 		APLICACIÓN / DESCRIPTION	DAI PARTS #	DAI KIT PARTS #
BASES PARA AMORTIGUADOR / STRUT MOUNTS				
05-12		BASE PARA AMORTIGUADOR FRONTAL IZQUIERDA Y DERECHA		7634-KIT
96-04		BASE PARA AMORTIGUADOR FRONTAL IZQUIERDA Y DERECHA		7635-KIT



 		APLICACIÓN / DESCRIPTION	DAI PARTS #
MISCELÁNEOS / AUTOMOTIVE RUBBER PARTS			
	87-95	BUJE PARA MUELLE (POLIURETANO)	9160
		BUJE TENSOR (TIPO YOYO POLIURETANO)	9170



PLATINA

 		APLICACIÓN / DESCRIPTION	DAI PARTS #
SOPORTES / TRANSMISSION & MOTOR MOUNTS			
L4 1.6	02-10	SOPORTE PARA MOTOR DERECHO	7005
		SOPORTE PARA MOTOR DERECHO	7005-H
		SOPORTE PARA MOTOR TRASERO STD.	7006
		REPUESTO PARA SOPORTE MOTOR TRASERO STD. (7006)	7006-9
		SOPORTE PARA MOTOR TRASERO AUT.	7007
		SOPORTE PARA TRANSMISIÓN STD.	7008
		SOPORTE PARA TRANSMISIÓN AUT.	7009

**SOPORTES
TRANSMISSION & MOTOR MOUNTS**



7005



7005-H



7006



7006-9



7007



7008



7009

		APLICACIÓN / DESCRIPTION	DAI PARTS #	DAI KIT PARTS #
BASES PARA AMORTIGUADOR / STRUT MOUNTS				
02-10	BASE PARA AMORTIGUADOR FRONTAL IZQUIERDA Y DERECHA	7017	7017-KIT	
	BALERO PARA BASE DE AMORTIGUADOR (7017)	6147		

**BASES PARA AMORTIGUADOR
STRUT MOUNTS**



6147



7017



7017-KIT



CONTINUACIÓN... PLATINA



		APLICACIÓN / DESCRIPTION	DAI PARTS #
CUBRE POLVOS / C.V. BOOTS			
02-10		CUBRE POLVO IZQUIERDO Y DERECHO LADO RUEDA	6315
		CUBRE POLVO DERECHO LADO CAJA (CON TRIPOIDE)	6329
		CUBRE POLVO IZQUIERDO LADO CAJA	6331
		CUBRE POLVO IZQUIERDO Y DERECHO DE DIRECCIÓN HID.	6347
		CUBRE POLVO IZQUIERDO DE DIRECCIÓN HID.	6348

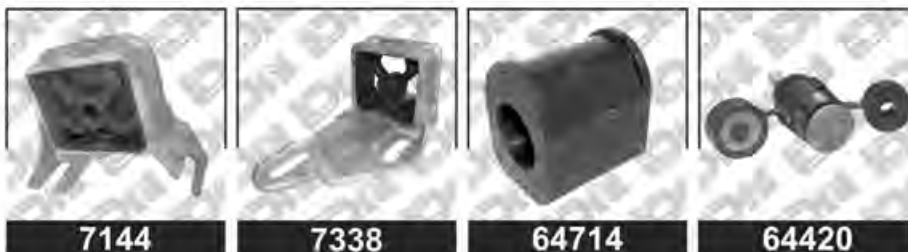

MISCELÁNEOS / AUTOMOTIVE RUBBER PARTS			
02-10		TOPE PARA AMORTIGUADOR FRONTAL IZQUIERDO Y DERECHO	2010
		TOPE PARA AMORTIGUADOR TRASERO IZQUIERDO Y DERECHO	2013
		GOMA SUJETADORA DE ESCAPE	7144
		GOMA SUJETADORA DE ESCAPE	7338
		TORNILLO ESTABILIZADOR FRONTAL IZQUIERDO Y DERECHO	64420
		GOMA PARA BARRA ESTABILIZADORA	64714



CONTINUACIÓN... PLATINA

 		APLICACIÓN / DESCRIPTION	DAI PARTS #
MISCELÁNEOS / AUTOMOTIVE RUBBER PARTS			
02-10		GOMA PARA BARRA ESTABILIZADORA	DAI-1416020
		BUJES PARA EJE TRASERO	DAI-1416021
		BUJES PARA HORQUILLA INFERIOR	DAI-7700-424-399
03-10		GOMA PARA BARRA ESTABILIZADORA	6421

**MISCELÁNEOS
AUTOMOTIVE RUBBER PARTS**



6421



DAI-1416020



DAI-1416021



DAI-7700-424-399

PICK UP

SOPORTES / TRANSMISSION & MOTOR MOUNTS			
V6 3.0	1995	SOPORTE PARA MOTOR IZQUIERDO Y DERECHO	7743

**SOPORTES
TRANSMISSION & MOTOR MOUNTS**



7743

QUEST

SOPORTES / TRANSMISSION & MOTOR MOUNTS			
V6 3.0	93-98	SOPORTE PARA TRANSMISIÓN	7167
		SOPORTE PARA MOTOR FRONTAL	7168

**SOPORTES
TRANSMISSION & MOTOR MOUNTS**



7167



7168



CONTINUACIÓN... QUEST

		APLICACIÓN / DESCRIPTION	DAI PARTS #
SOPORTES / TRANSMISSION & MOTOR MOUNTS			
V6 3.0	93-98	SOPORTE PARA MOTOR TRASERO	7169
		SOPORTE PARA MOTOR TRASERO DERECHO	7170
V6 3.3	99-03	SOPORTE PARA TRANSMISIÓN	7167
		SOPORTE PARA MOTOR TRASERO DERECHO	7170
		SOPORTE PARA MOTOR FRONTAL	7171
V6 3.5	04-10	SOPORTE PARA MOTOR DERECHO	7247
		REPUESTO PARA SOPORTE DE MOTOR DERECHO (7104 Y 7247)	7104-9
		SOPORTE PARA MOTOR FRONTAL	7266-EL
		SOPORTE PARA MOTOR TRASERO AUT. 5 VEL. (SOLIDO SIN ACTUADOR)	7267
		SOPORTE PARA MOTOR TRASERO	7267-EL
	SOPORTE PARA TRANSMISIÓN AUT.	7395	
	11-16	SOPORTE PARA MOTOR TRASERO	7699

**SOPORTES
TRANSMISSION & MOTOR MOUNTS**

7104-9

7167

7169

7170

7171

7247

7266-EL

7267

7267-EL

7395

7699

	APLICACIÓN / DESCRIPTION	DAI PARTS #	DAI KIT PARTS #
BASES PARA AMORTIGUADOR / STRUT MOUNTS			
93-98	BASE PARA AMORTIGUADOR FRONTAL IZQUIERDA Y DERECHA		7221-KIT
04-08	BASE PARA AMORTIGUADOR FRONTAL IZQUIERDA Y DERECHA		7300-KIT

**BASES PARA AMORTIGUADOR
STRUT MOUNTS**

7221-KIT

7300-KIT

CONTINUACIÓN... QUEST

28	APLICACIÓN / DESCRIPTION	DAI PARTS #	DAI KIT PARTS #
BASES PARA AMORTIGUADOR / STRUT MOUNTS			
04-09	BASE PARA AMORTIGUADOR TRASERA IZQUIERDA Y DERECHA		7637-KIT



28	APLICACIÓN / DESCRIPTION	DAI PARTS #
CUBRE POLVOS / C.V. BOOTS		
04-10	CUBRE POLVO IZQUIERDO Y DERECHO DE DIRECCIÓN	63196
	CUBRE POLVO IZQUIERDO Y DERECHO LADO RUEDA	63193
11-15	CUBRE POLVO IZQUIERDO Y DERECHO LADO CAJA	63194
	CUBRE POLVO IZQUIERDO Y DERECHO DE DIRECCIÓN	63195



MISCELÁNEOS / AUTOMOTIVE RUBBER PARTS		
93-03	BUJE PARA HORQUILLA GRANDE	DAI-54570-6B010
	BUJES PARA HORQUILLA INFERIOR CHICO	DAI-54560-0B000



CONTINUACIÓN... QUEST

  28		APLICACIÓN / DESCRIPTION	DAI PARTS #
MISCELÁNEOS / AUTOMOTIVE RUBBER PARTS			
04-08	TORNILLO ESTABILIZADOR FRONTAL DERECHO		DAI-2116024
	TORNILLO ESTABILIZADOR FRONTAL IZQUIERDO		DAI-2116025
04-10	TORNILLO ESTABILIZADOR FRONTAL		64620

ROGUE

SOPORTES / TRANSMISSION & MOTOR MOUNTS			
L4 2.5	08-14	SOPORTE PARA MOTOR TRASERO	7405
		SOPORTE PARA MOTOR DERECHO SUPERIOR (TORSIÓN)	7409
		SOPORTE PARA MOTOR DERECHO	7693-H
	14-17	SOPORTE PARA TRANSMISIÓN	7719-H
		SOPORTE PARA MOTOR DERECHO	7720-H
		SOPORTE PARA MOTOR TRASERO TORQUE STRUT	7721
		SOPORTE PARA MOTOR DERECHO SUPERIOR TORQUE STRUT	7722



CONTINUACIÓN... ROGUE



28	APLICACIÓN / DESCRIPTION	DAI PARTS #	DAI KIT PARTS #
BASES PARA AMORTIGUADOR / STRUT MOUNTS			
08-14	BASE PARA AMORTIGUADOR FRONTAL IZQUIERDA		7410-KIT
	BASE PARA AMORTIGUADOR FRONTAL DERECHA		7411-KIT
	BALERO PARA BASE DE AMORTIGUADOR FRONTAL IZQUIERDA Y DERECHA 7357, 7394, 7410-KIT Y 7411-KIT	6149	



28	APLICACIÓN / DESCRIPTION	DAI PARTS #
CUBRE POLVOS / C.V. BOOTS		
08-14	CUBRE POLVO IZQUIERDO Y DERECHO LADO CAJA (CON TRIPOIDE)	6328
	CUBRE POLVO IZQUIERDO Y DERECHO LADO CAJA (CON TRIPOIDE)	63161
	CUBRE POLVO IZQUIERDO Y DERECHO LADO RUEDA	63162
	CUBRE POLVO IZQUIERDO Y DERECHO LADO RUEDA	63173
08-15	CUBRE POLVO IZQUIERDO Y DERECHO DE DIRECCIÓN	63163



CONTINUACIÓN... ROGUE

	 28	APLICACIÓN / DESCRIPTION	DAI PARTS #
MISCELÁNEOS / AUTOMOTIVE RUBBER PARTS			
08-14		BUJES PARA HORQUILLA (POLIURETANO KIT)	9806
		KIT DE BUJES PARA PUENTE Ó BASTIDOR (2 CHICOS Y 2 GRANDES)	64823

SAKURA

MISCELÁNEOS / AUTOMOTIVE RUBBER PARTS			
74-04		COPE PARA DIRECCIÓN (SINFÍN DE .570" 2 PERNOS UNIVERSALES)	608
		COPE PARA DIRECCIÓN MODELO ESPECIAL (SINFÍN DE .675" NO REQUIERE PERNOS)	631
82-87		TORNILLO ESTABILIZADOR (5", 154.2400")	6100
		TORNILLO ESTABILIZADOR (5", 154.2400" EQUIPO ORIGINAL)	6104
		GOMA PARA TIRANTE DE SUSPENSIÓN	64400

SAMURAY

MISCELÁNEOS / AUTOMOTIVE RUBBER PARTS			
74-04		COPE PARA DIRECCIÓN (SINFÍN DE .570" 2 PERNOS UNIVERSALES)	608
		COPE PARA DIRECCIÓN MODELO ESPECIAL (SINFÍN DE .675" NO REQUIERE PERNOS)	631



CONTINUACIÓN... SAMURAY

	28	APLICACIÓN / DESCRIPTION	DAI PARTS #
MISCELÁNEOS / AUTOMOTIVE RUBBER PARTS			
	74-84	TOPE PARA AMORTIGUADOR FRONTAL IZQUIERDO Y DERECHO	D-0620



SEDAN

MISCELÁNEOS / AUTOMOTIVE RUBBER PARTS			
		GOMA SUJETADORA DE ESCAPE	6542
		GOMA SUJETADORA DE ESCAPE	6543
		BUJE PORTA MANGO	6069
	65-67	CUBRE POLVO PARA PALANCA DE VELOCIDADES	6080
	65-78	GOMA PARA TIRANTE DE SUSPENSIÓN	64390
		GOMAS PARA TIRANTE DE SUSPENSIÓN	6054
	68-73	CUBRE POLVO PARA PALANCA DE VEL.	6081
	69-84	TORNILLO ESTABILIZADOR (5", 1543.24 mm)	6100
		TORNILLO ESTABILIZADOR (5", 154.24 mm EQUIPO ORIGINAL)	6104
	71-79	BUJE PARA HORQUILLA INFERIOR	2359

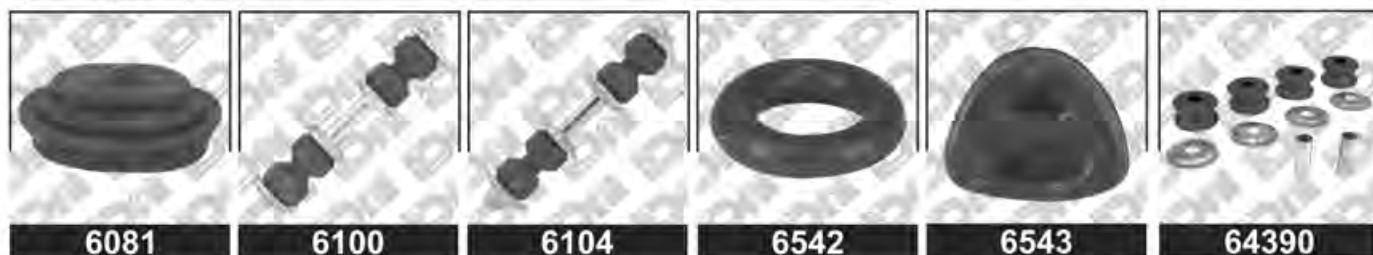

CONTINUACIÓN... SEDAN



	 28	APLICACIÓN / DESCRIPTION	DAI PARTS #
MISCELÁNEOS / AUTOMOTIVE RUBBER PARTS			
	74-78	CUBRE POLVO PARA PALANCA DE VEL	6082
		CUBRE POLVO PARA PALANCA DE VEL.	6083
	79-84	GOMA PARA TIRANTE DE SUSPENSIÓN	64400
		GOMAS PARA TIRANTE DE SUSPENSIÓN	6052
	80-84	BUJE PARA HORQUILLA INFERIOR	2360

SENTRA

SOPORTES / TRANSMISSION & MOTOR MOUNTS			
L4 1.6	2017	SOPORTE PARA MOTOR DERECHO SUPERIOR	7546
	17-18	SOPORTE PARA TRANSMISIÓN	7441
L4 1.8	00-06	SOPORTE PARA TRANSMISIÓN AUT.	7040
		SOPORTE PARA MOTOR TRASERO	7010
	01-06	REPUESTO PARA SOPORTE MOTOR TRASERO (7010)	1944
		REPUESTO PARA SOPORTE DE TRANSMISIÓN (7040)	7217-9
	SOPORTE PARA MOTOR DERECHO	7038	



CONTINUACIÓN... SENTRA

		 28	APLICACIÓN / DESCRIPTION	DAI PARTS #
SOPORTES / TRANSMISSION & MOTOR MOUNTS				
L4 1.8	01-06		SOPORTE PARA MOTOR FRONTAL	7067
			SOPORTE PARA TRANSMISIÓN STD.	7069
			REPUESTO PARA SOPORTE DE TRANSMISIÓN STD. (7069)	7069-9
	13-16		SOPORTE PARA TRANSMISIÓN	7441
			SOPORTE PARA MOTOR TRASERO	7493
			SOPORTE PARA MOTOR DERECHO SUPERIOR	7546
13-17		SOPORTE PARA MOTOR DERECHO INFERIOR	7659-H	
L4 2.0	96-00		SOPORTE PARA MOTOR DERECHO	6802
			SOPORTE PARA MOTOR TASERO AUT.	6806
			SOPORTE PARA MOTOR TRASERO STD.	6807
			SOPORTE PARA TRANSMISIÓN TRASERO	6805
	96-06		SOPORTE PARA MOTOR TRASERO	7010
			REPUESTO PARA SOPORTE MOTOR TRASERO (7010)	1944
			SOPORTE PARA MOTOR FRONTAL	7067
			REPUESTO PARA SOPORTE DE TRANSMISIÓN (USA) (6805 Y 6824)	6821
			SOPORTE PARA MOTOR DERECHO	6970

SOPORTES TRANSMISSION & MOTOR MOUNTS

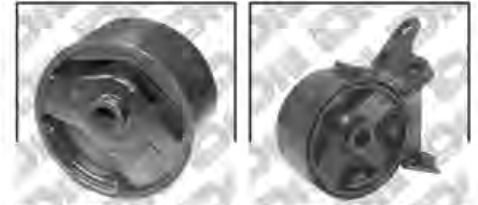

1944 6802



6805 6806

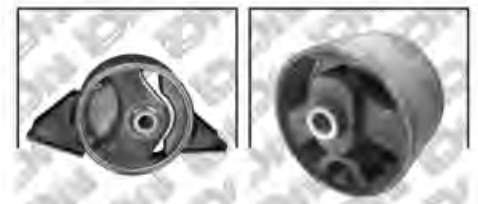

6807 6821



6970 7010



7067 7069 7069-9 7441







7493 7546 7659-H



IMPORTANTE: Identifica nuestro producto con el grabado del logo  No aceptes imitaciones.



CONTINUACIÓN... SENTRA

 		APLICACIÓN / DESCRIPTION	DAI PARTS #	SOPORTES TRANSMISSION & MOTOR MOUNTS	
SOPORTES / TRANSMISSION & MOTOR MOUNTS					
L4 2.0	96-06	REPUESTO PARA SOPORTE DE MOTOR DERECHO (6970)	6970-9		
	07-12	SOPORTE PARA MOTOR TASERO	7219		
		SOPORTE PARA MOTOR DERECHO	7218-H		
		SOPORTE PARA TRANSMISIÓN STD.	7322		
		SOPORTE PARA TRANSMISIÓN AUT.	7390		
		SOPORTE PARA MOTOR FRONTAL STD.	7656		
L4 2.5	00-06	SOPORTE PARA TRANSMISIÓN STD. (SE-R)	7069		
	02-06	REPUESTO PARA SOPORTE DE TRANSMISIÓN STD. (7069) (SE-R)	7069-9		
	02-06	SOPORTE PARA MOTOR TRASERO (SE-R)	7010		
		REPUESTO PARA SOPORTE MOTOR TRASERO (7010)	1944		
		SOPORTE PARA TRANSMISIÓN AUT. (SE-R)	7040		
		REPUESTO PARA SOPORTE MOTOR DE TRANSMISIÓN (7032, 7040 Y 7265) (SE-R)	7217-9		
		SOPORTE PARA MOTOR FRONTAL (SE-R)	7067		
		SOPORTE PARA MOTOR FRONTAL	7618		
		07-13	SOPORTE PARA MOTOR DERECHO (SE-R)		
	SOPORTE PARATRANSMISIÓN (SE-R)		7719-H		
		 NUEVO	 NUEVO		
 NUEVO	 NUEVO				
7322	7390	7618	7656	7069-9	7217-9
7693-H	7719-H			7218-H	7219



CONTINUACIÓN... SENTRA

 		APLICACIÓN / DESCRIPTION	DAI PARTS #
SOPORTES / TRANSMISSION & MOTOR MOUNTS			
L4 2.5	07-13	SOPORTE PARA MOTOR TRASERO (SE-R)	7405
		SOPORTE PARA MOTOR DERECHO SUPERIOR TORSIÓN (SE-R)	7409
L4 1600	1991	REPUESTO PARA SOPORTE DE TRANSMISIÓN (USA) (6805 Y 6824)	6821
L4 1800	1991	REPUESTO PARA SOPORTE DE TRANSMISIÓN (USA) (6805 Y 6824)	6821
	00-06	SOPORTE PARA PALANCA DE VELOCIDADES	6827



		APLICACIÓN / DESCRIPTION	DAI PARTS #	DAI KIT PARTS #
BASES PARA AMORTIGUADOR / STRUT MOUNTS				
96-00		REPUESTO BASE DE AMORTIGUADOR FRONTAL IZQUIERDA Y DERECHA	6716	6716-KIT
		BASE PARA AMORTIGUADOR FRONTAL IZQUIERDA Y DERECHA	6717	6717-KIT
		BALERO PARA BASES DE AMORTIGUADOR 6716-KIT, 7298-KIT, 7300-KIT Y 6717-KIT	6142	
00-06		BASE PARA AMORTIGUADOR TRASERA IZQUIERDA Y DERECHA		7318-KIT
		BASE PARA AMORTIGUADOR FRONTAL IZQUIERDA Y DERECHA	7026	7026-KIT
02-06		BASE PARA AMORTIGUADOR FRONTAL IZQUIERDA Y DERECHA (SE-R)		
		BASE PARA AMORTIGUADOR TRASERA IZQUIERDA Y DERECHA (SE-R)		7318-KIT



CONTINUACIÓN... SENTRA

28	APLICACIÓN / DESCRIPTION	DAI PARTS #	DAI KIT PARTS #
BASES PARA AMORTIGUADOR / STRUT MOUNTS			
07-12	BASE PARA AMORTIGUADOR FRONTAL IZQUIERDA		7410-KIT
	BASE PARA AMORTIGUADOR FRONTAL DERECHA		7411-KIT
	BALERO PARA BASE DE AMORTIGUADOR FRONTAL IZQUIERDO Y DERECHO 7357, 7394, 7410-KIT Y 7411-KIT	6149	
13-18	BESE PARA AMORTIGUADOR FRONTAL DERECHA	7357	7357-KIT
	BASE PARA AMORTIGUADOR FRONTAL IZQUIERDA	7394	7394-KIT



28	APLICACIÓN / DESCRIPTION	DAI PARTS #
CUBRE POLVOS / C.V. BOOTS		
87-90	CUBRE POLVO IZQUIERDO LADO RUEDA	6309
	CUBRE POLVO IZQUIERDO Y DERECHO LADO RUEDA	6360
96-00	CUBRE POLVO IZQUIERDO Y DERECHO LADO RUEDA	6392
	CUBRE POLVO IZQUIERDO Y DERECHO LADO CAJA	6390



CONTINUACIÓN... SENTRA

	28	APLICACIÓN / DESCRIPTION	DAI PARTS #
CUBRE POLVOS / C.V. BOOTS			
96-00		CUBRE POLVO IZQUIERDO Y DERECHO DE DIRECCIÓN HID.	6376
		CUBRE POLVO IZQUIERDO Y DERECHO DE DIRECCIÓN STD.	6335
		CUBRE POLVO IZQUIERDO Y DERECHO DE DIRECCIÓN STD.	6336
		CUBRE POLVO IZQUIERDO Y DERECHO DE DIRECCIÓN HID.	6345
00-06		CUBRE POLVO IZQUIERDO Y DERECHO LADO CAJA (CON TRIPOIDE)	6310
		CUBRE POLVO IZQUIERDO Y DERECHO LADO CAJA (CON TRIPOIDE)	6328
07-12		CUBRE POLVO IZQUIERDO Y DERECHO LADO CAJA (CON TRIPOIDE)	6398
		CUBRE POLVO IZQUIERDO Y DERECHO LADO CAJA (CON TRIPOIDE)	63174
		CUBRE POLVO IZQUIERDO Y DERECHO DE DIRECCIÓN	63175
		CUBRE POLVO IZQUIERDO Y DERECHO LADO RUEDA	63191
07-13		CUBRE POLVO IZQUIERDO Y DERECHO LADO RUEDA	63173



CONTINUACIÓN... SENTRA

28		APLICACIÓN / DESCRIPTION	DAI PARTS #	MISCELÁNEOS / AUTOMOTIVE RUBBER PARTS	
	87-90	BUJE PARA HORQUILLA INFERIOR GRANDE	64610	 D-0619	 2002
	87-00	BUJE PARA HORQUILLA TRASERA SUPERIOR	64670		
	91-95	BUJES PARA HORQUILLA INFERIOR CHICO Y GRANDE (POLIURETANO KIT)	9801	 9801	 9806
		BUJE PARA HORQUILLA GRANDE (PUNTA)	64660		
	96-00	TOPE PARA AMORTIGUADOR FRONTAL IZQUIERDO Y DERECHO	D-0619	 9801	 9806
		TOPE PARA AMORTIGUADOR TRASERO IZQUIERDO Y DERECHO (HULE)	2002		
	96-06	TORNILLO ESTABILIZADOR FRONTAL	64620	 64610	 64620
		BUJE PARA EJE TRASERO	DAI-1416053		
		BUJE PARA EJE TRASERO	64810		
	00-06	GOMA PARA BARRA ESTABILIZADORA	64715	 64610	 64620
		BUJE PARA HORQUILLA CHICO	DAI-1416003		
		BUJE PARA HORQUILLA GRANDE	DAI-1416004		
		GOMA PARA BARRA ESTABILIZADORA	DAI-1416019		
	07-12	BUJES PARA HORQUILLA (POLIURETANO KIT)	9806		



CONTINUACIÓN... SENTRA

 28	APLICACIÓN / DESCRIPTION	DAI PARTS #
MISCELÁNEOS / AUTOMOTIVE RUBBER PARTS		
07-12	KIT DE BUJES PARA PUENTE Ó BASTIDOR (2 CHICOS Y 2 GRANDES)	64822
	TORNILLO ESTABILIZADOR FRONTAL	DAI-2116018
13-16	BUJES PARA HORQUILLA (POLIURETANO KIT)	9807
	BUJE PARA HORQUILLA INFERIOR CHICO	DAI-1416007
14-16	GOMAS PARA BARRA ESTABILIZADORA EN POLIURETANO (2 PIEZAS)	9811



STANZA

 28	APLICACIÓN / DESCRIPTION	DAI PARTS #	DAI KIT PARTS #
BASES PARA AMORTIGUADOR / STRUT MOUNTS			
86-92	BASE PARA AMORTIGUADOR FRONTAL IZQUIERDA Y DERECHA	6743	6743-KIT
	BASE PARA AMORTIGUADOR FRONTAL DERECHA		7297-KIT



CONTINUACIÓN... STANZA

28		APLICACIÓN / DESCRIPTION	DAI PARTS #
MISCELÁNEOS / AUTOMOTIVE RUBBER PARTS			
86-92	TOPE PARA AMORTIGUADOR FRONTAL IZQUIERDO Y DERECHO	D-0622	
87-89	TOPE PARA AMORTIGUADOR FRONTAL Y TRASERO IZQUIERDO Y DERECHO	D-0621	

TIIDA

SOPORTES / TRANSMISSION & MOTOR MOUNTS			
L4 1.8	06-17	SOPORTE PARA MOTOR TRASERO	7196
		SOPORTE PARA TRANSMISIÓN	7197
		SOPORTE PARA MOTOR DERECHO SUPERIOR	7203
		SOPORTE PARA MOTOR DERECHO	7399-H



CONTINUACIÓN... TIIDA

28	APLICACIÓN / DESCRIPTION	DAI PARTS #	DAI KIT PARTS #
BASES PARA AMORTIGUADOR / STRUT MOUNTS			
06-17	BALERO PARA BASE DE AMORTIGUADOR FRONTAL IZQUIERDA Y DERECHA 7357, 7394, 7410-KIT Y 7411-KIT	6149	
	BASE PARA AMORTIGUADOR FRONTAL IZQUIERDA	7394	7394-KIT



28	APLICACIÓN / DESCRIPTION	DAI PARTS #
CUBRE POLVOS / C.V. BOOTS		
06-17	CUBRE POLVO IZQUIERDO Y DERECHO LADO RUEDA	63141
	CUBRE POLVO IZQUIERDO Y DERECHO LADO CAJA (CON TRIPOIDE)	63142
	CUBRE POLVO IZQUIERDO Y DERECHO DE DIRECCIÓN	63143



MISCELÁNEOS / AUTOMOTIVE RUBBER PARTS		
06-17	TOPE PARA AMORTIGUADOR Y CUBRE POLVO FRONTAL IZQUIERDO Y DERECHO	2009
	BUJES PARA HORQUILLA (POLIURETANO KIT)	9807



CONTINUACIÓN... TIDA

28		APLICACIÓN / DESCRIPTION	DAI PARTS #
MISCELÁNEOS / AUTOMOTIVE RUBBER PARTS			
06-17	GOMAS PARA BARRA ESTABILIZADORA FRONTAL IZQ. Y DER. EN POLIURETANO 2 PIEZAS		9811
	BUJE PARA HORQUILLA INFERIOR CHICO		DAI-1416007
	BUJE PARA HORQUILLA INFERIOR GRANDE		DAI-1416009
	TORNILLO ESTABILIZADOR FRONTAL		DAI-2116019

TITAN

SOPORTES / TRANSMISSION & MOTOR MOUNTS			
V8 5.6	04-10	SOPORTE PARA TRANSMISIÓN (4X4)	7274
		SOPORTE PARA MOTOR IZQUIERDO Y DERECHO	7275
		SOPORTE PARA TRANSMISIÓN (4X2)	7324



TSUBAME

	28	APLICACIÓN / DESCRIPTION	DAI PARTS #
--	----	--------------------------	-------------

SOPORTES / TRANSMISSION & MOTOR MOUNTS

L4 1.6 L4 1.8	92-10	REPUESTO PARA SOPORTE DE TRANSMISIÓN (USA) (6805 Y 6824)	6821
		SOPORTE PARA MOTOR FRONTAL STD.	6684
	93-04	SOPORTE PARA MOTOR DERECHO	6686
		SOPORTE PARA MOTOR DERECHO	6802
		SOPORTE PARA TRANSMISIÓN	6685
		SOPORTE PARA MOTOR TRASERO	6694
		REPUESTO PARA SOPORTE DE MOTOR IZQUIERDO Y DERECHO (6686, 6802, 6685 y 6854)	1941
		REPUESTO PARA SOPORTE DE MOTOR FRONTAL STD. (6684)	6689
		SOPORTE PARA MOTOR DERECHO	6854
		SOPORTE PARA MOTOR DERECHO (16 VÁLVULAS)	6970
REPUESTO PARA SOPORTE DE MOTOR DERECHO (16 VÁLVULAS) (6970)	6970-9		

L4 2.0	93-04	SOPORTE PARA MOTOR FRONTAL STD.	6684
		SOPORTE PARA MOTOR DERECHO	6686
		SOPORTE PARA MOTOR DERECHO	6802
		SOPORTE PARA TRANSMISIÓN	6685
		SOPORTE PARA MOTOR TRASERO	6694
		REPUESTO PARA SOPORTE DE MOTOR IZQUIERDO Y DERECHO (6686, 6802, 6685 y 6854)	1941
		REPUESTO PARA SOPORTE DE MOTOR FRONTAL STD. (6684)	6689

SOPORTES TRANSMISSION & MOTOR MOUNTS



1941 6684



6685 6686



6689 6694

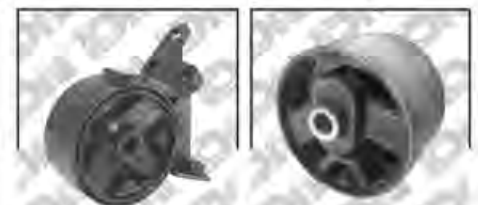

6802 6821





6854 6970 6970-9

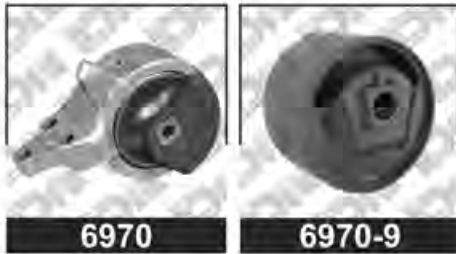

CONTINUACIÓN... TSUBAME

 		APLICACIÓN / DESCRIPTION	DAI PARTS #
SOPORTES / TRANSMISSION & MOTOR MOUNTS			
L4 2.0	93-04	SOPORTE PARA MOTOR DERECHO	6854
		SOPORTE PARA MOTOR DERECHO (16 VÁLVULAS)	6970
		REPUESTO PARA SOPORTE DE MOTOR DERECHO (16 VÁLVULAS) (6970)	6970-9
	92-10	SOPORTE PARA PALANCA DE VELOCIDADES	6827



		APLICACIÓN / DESCRIPTION	DAI PARTS #	DAI KIT PARTS #
BASES PARA AMORTIGUADOR / STRUT MOUNTS				
93-04		REPUESTO BASE DE AMORTIGUADOR FRONTAL IZQUIERDA Y DERECHA	6716	6716-KIT
		BASE PARA AMORTIGUADOR FRONTAL IZQUIERDA Y DERECHA	6717	6717-KIT
		BASE PARA AMORTIGUADOR FRONTAL IZQUIERDA Y DERECHA (16 VALVULAS)	6717	6717-KIT
		BALERO PARA BASE DE AMORTIGUADOR 6716-KIT, 7298-KIT, 7300-KIT Y 6717-KIT	6142	
		BALERO PARA BASE DE AMORTIGUADOR (16 VÁLVULAS) 6716-KIT, 7298-KIT, 7300-KIT Y 6717-KIT	6142	



CONTINUACIÓN... TSUBAME

	 28	APLICACIÓN / DESCRIPTION	DAI PARTS #
CUBRE POLVOS / C.V. BOOTS			
93-04		CUBRE POLVO IZQUIERDO DE DIRECCIÓN STD.	6335
		CUBRE POLVO DERECHO DE DIRECCIÓN	6336
		CUBRE POLVO IZQUIERDO Y DERECHO LADO RUEDA	6360
		CUBRE POLVO IZQUIERDO Y DERECHO LADO CAJA	6390
		CUBRE POLVO IZQUIERDO Y DERECHO LADO CAJA (CON TRIPOIDE)	6328
		CUBRE POLVO IZQUIERDO Y DERECHO DE DIRECCIÓN HID.	6376
		CUBRE POLVO IZQUIERDO Y DERECHO LADO CAJA	6392
		CUBRE POLVO IZQUIERDO Y DERECHO LADO RUEDA	6397
93-04		CUBRE POLVO IZQUIERDO Y DERECHO LADO CAJA (CON TRIPOIDE) (16 VÁLVULAS)	6328
		CUBRE POLVO IZQUIERDO DE DIRECCIÓN STD. (16 VÁLVULAS)	6335
		CUBRE POLVO DERECHO DE DIRECCIÓN (16 VÁLVULAS)	6336
		CUBRE POLVO IZQUIERDO Y DERECHO LADO RUEDA (16 VÁLVULAS)	6360
		CUBRE POLVO IZQUIERDO Y DERECHO LADO CAJA (16 VÁLVULAS)	6390
		CUBRE POLVO IZQUIERDO Y DERECHO DE DIRECCIÓN HID. (16 VÁLVULAS)	6376
		CUBRE POLVO IZQUIERDO Y DERECHO LADO CAJA (16 VÁLVULAS)	6392
		CUBRE POLVO IZQUIERDO Y DERECHO LADO RUEDA (16 VÁLVULAS)	6397



CONTINUACIÓN... TSUBAME

28		APLICACIÓN / DESCRIPTION	DAI PARTS #	MISCELÁNEOS / AUTOMOTIVE RUBBER PARTS	
93-04		TOPE PARA AMORTIGUADOR FRONTAL IZQUIERDO Y DERECHO	D-0619		
		TOPE PARA AMORTIGUADOR FRONTAL IZQUIERDO Y DERECHO (HULE)	2001		
		TOPE PARA AMORTIGUADOR TRASERO IZQUIERDO Y DERECHO (HULE)	2006		
		BUJES PARA HORQUILLA INFERIOR CHICO Y GRANDE (POLIURETANO KIT)	9801		
		JUEGO DE GOMAS PARA BARRA ESTABILIZADORA TRASERA EN POLIURETANO	9813		
		TORNILLO ESTABILIZADOR FRONTAL	64620		
		TORNILLO ESTABILIZADOR TRASERO	64630		
		BUJE PARA HORQUILLA TRASERA SUPERIOR	64670		
	BUJE PARA HORQUILLA GRANDE (PUNTA)	64660			
		64630			
		64660			
		64670			

TSURU I				SOPORTES / TRANSMISSION & MOTOR MOUNTS	
L4 1.6	84-87	SOPORTE PARA TRANSMISIÓN STD.	1817		
		SOPORTE PARA MOTOR FRONTAL	1830		



CONTINUACIÓN... TSURU I

  28		APLICACIÓN / DESCRIPTION	DAI PARTS #
SOPORTES / TRANSMISSION & MOTOR MOUNTS			
L4 1.6	84-87	SOPORTE PARA MOTOR TRASERO	1831
		REPUESTO PARA SOPORTE DE MOTOR DERECHO (6685)	1943
		SOPORTE PARA TRANSMISIÓN AUT.	1818
		SOPORTE PARA MOTOR DERECHO	6665
		SOPORTE PARA PALANCA DE VELOCIDADES	6825



CUBRE POLVOS / C.V. BOOTS		
84-87	CUBRE POLVO IZQUIERDO Y DERECHO LADO RUEDA	6305
	CUBRE POLVO IZQUIERDO Y DERECHO LADO CAJA	6330
	CUBRE POLVO IZQUIERDO Y DERECHO LADO CAJA	6390
	CUBRE POLVO IZQUIERDO DE DIRECCIÓN STD.	6355
	CUBRE POLVO DERECHO DE DIRECCIÓN STD.	6365
	CUBRE POLVO DERECHO DE DIRECCIÓN HID.	6366
	CUBRE POLVO IZQUIERDO DE DIRECCIÓN HID.	6379



CONTINUACIÓN... TSURU I

28		APLICACIÓN / DESCRIPTION	DAI PARTS #	MISCELÁNEOS / AUTOMOTIVE RUBBER PARTS	
84-87	TOPE PARA AMORTIGUADOR FRONTAL IZQUIERDO Y DERECHO	D-0619			
	GOMA SUJETADORA DE ESCAPE	FP08			
	GOMA SUJETADORA DE ESCAPE	FP09			
	GOMA PARA CREMALLERA DE DIRECCIÓN (DERECHA PAR 703)	702			
	GOMA PARA CREMALLERA DE DIRECCIÓN IZQUIERDA Y DERECHA	705			
	TOPE PARA AMORTIGUADOR FRONTAL IZQUIERDO Y DERECHO (HULE)	2000			
	TOPE PARA AMORTIGUADOR TRASERO IZQUIERDO Y DERECHO (HULE)	2004			
	TORNILLO ESTABILIZADOR	6108			
	GOMA PARA BARRA ESTABILIZADORA	6416			
	CUBRE POLVO PARA PALANCA DE VELOCIDADES	6553			



TSURU II

 		APLICACIÓN / DESCRIPTION	DAI PARTS #
SOPORTES / TRANSMISSION & MOTOR MOUNTS			
L4 1.6 L4 1.8	88-91	SOPORTE PARA PALANCA DE VELOCIDADES	6826
		REPUESTO SOPORTE DE MOTOR DERECHO	1908
		SOPORTE PARA MOTOR TRASERO	1901
		SOPORTE PARA MOTOR FRONTAL	1902
		REPUESTO SOPORTE DE TRANSMISIÓN STD.	6822
		SOPORTE PARA TRANSMISIÓN STD.	6803



	APLICACIÓN / DESCRIPTION	DAI PARTS #	DAI KIT PARTS #
BASES PARA AMORTIGUADOR / STRUT MOUNTS			
88-91	REPUESTO PARA BASE DE AMORTIGUADOR FRONTAL IZQUIERDA Y DERECHA	6716	6716-KIT
	BALERO PARA BASE DE AMORTIGUADOR 6716-KIT, 7298-KIT, 7300-KIT, 6717-KIT Y 7026	6142	



CONTINUACIÓN... TSURU II

		APLICACIÓN / DESCRIPTION	DAI PARTS #
CUBRE POLVOS / C.V. BOOTS			
88-91		CUBRE POLVO IZQUIERDO Y DERECHO LADO RUEDA	6360
		CUBRE POLVO IZQUIERDO Y DERECHO LADO CAJA	6375
		CUBRE POLVO IZQUIERDO DE DIRECCIÓN STD.	6355
		CUBRE POLVO DERECHO DE DIRECCIÓN STD.	6365
		CUBRE POLVO DERECHO DE DIRECCIÓN HID.	6366
		CUBRE POLVO IZQUIERDO DE DIRECCIÓN HID.	6379

**CUBRE POLVOS
C.V. BOOTS**

6355

6360

6365

6366

6375

6379
MISCELÁNEOS / AUTOMOTIVE RUBBER PARTS

88-91		TOPE PARA AMORTIGUADOR FRONTAL Y TRASERO IZQUIERDO Y DERECHO	D-0619
		GOMA SUJETADORA DE ESCAPE	FP06
		GOMA SUJETADORA DE ESCAPE	FP07
		GOMA PARA BARRA ESTABILIZADORA TRASERA	74
		GOMA PARA RADIADOR	507
		GALLETAS PARA DIRECCIÓN STD. Y HID. (NO INCLUYE PERNOS NI BUJES)	628

**MISCELÁNEOS
AUTOMOTIVE RUBBER PARTS**

D-0619

FP06

FP07

74

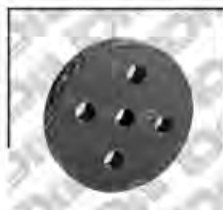
507

628

CONTINUACIÓN... TSURU II

  28		APLICACIÓN / DESCRIPTION	DAI PARTS #
MISCELÁNEOS / AUTOMOTIVE RUBBER PARTS			
88-91		GOMA PARA CREMALLERA DE DIRECCIÓN (DERECHA PAR 703)	702
		GOMA PARA CREMALLERA DE DIRECCIÓN (IZQUIERDA PAR 702)	703
		GOMA PARA CREMALLERA DE DIRECCIÓN (DERECHA PAR 702)	704
		GOMA PARA CREMALLERA DE DIRECCIÓN (DERECHA PAR 718)	706
		GOMA PARA CREMALLERA DE DIRECCIÓN (DERECHA REFORZADA PAR 718)	707
		TOPE PARA AMORTIGUADOR FRONTAL IZQUIERDO Y DERECHO (HULE)	2000
		GOMA PARA BARRA ESTABILIZADORA	6415
		CUBRE POLVO PARA PALANCA DE VELOCIDADES	6553
		TOPE PARA AMORTIGUADOR TRASERO IZQUIERDO Y DERECHO (HULE)	2004
		GOMA PARA BARRA TRASERA	64510
		GOMA PARA BARRA TRASERA (COMPLEMENTO)	64520
		BUJE PARA HORQUILLA INFERIOR GRANDE	64610
		TORNILLO ESTABILIZADOR FRONTAL	64620
	TORNILLO ESTABILIZADOR TRASERO	64630	

**MISCELÁNEOS
AUTOMOTIVE RUBBER PARTS**

702

703

704



706



707



2000



2004



6415



6553

64510

64520

64610

64620

64630



CONTINUACIÓN... TSURU II

 		APLICACIÓN / DESCRIPTION	DAI PARTS #
MISCELÁNEOS / AUTOMOTIVE RUBBER PARTS			
88-91		BUJE PARA HORQUILLA TRASERA SUPERIOR	64670
		GOMA PARA TIRANTE DE SUSPENSIÓN (COMPLETO)	64700
		GOMA PARA BARRA ESTABILIZADORA	64690
		BUJE PARA TIRANTE TRASERO	DAI-55152-50A10

64700

DAI-55152-50A10
TSURU III

SOPORTES / TRANSMISSION & MOTOR MOUNTS			
	92-16	SOPORTE PARA PALANCA DE VELOCIDADES	6827
		SOPORTE PARA PALANCA DE VELOCIDADES	7027
L4 1.6	92-16	SOPORTE PARA MOTOR FRONTAL STD.	6684
		REPUESTO PARA SOPORTE DE MOTOR FRONTAL STD. (6684)	6689
		SOPORTE PARA MOTOR DERECHO	6686
		SOPORTE PARA MOTOR DERECHO	6802
		SOPORTE PARA TRANSMISIÓN	6685

6802

6827

7027

CONTINUACIÓN... TSURU III

		APLICACIÓN / DESCRIPTION	DAI PARTS #
---	---	---------------------------------	--------------------

SOPORTES / TRANSMISSION & MOTOR MOUNTS

L4 1.6	92-16	SOPORTE PARA MOTOR TRASERO	6694
		REPUESTO SOPORTES DE MOTOR IZQUIERDO Y DERECHO (6686, 6685, 6802 Y 6854)	1941
		SOPORTE PARA TRANSMISIÓN	6688
		SOPORTE PARA TRANSMISIÓN TRASERO (16 VÁLVULAS)	6824
		SOPORTE PARA MOTOR DERECHO	6854
		SOPORTE PARA MOTOR DERECHO (16 VÁLVULAS)	6970
		REPUESTO PARA SOPORTE DE MOTOR DERECHO (16 VÁLVULAS) (6970)	6970-9

L4 2.0	92-16	SOPORTE PARA MOTOR FRONTAL STD.	6684
		REPUESTO PARA SOPORTE DE MOTOR FRONTAL STD. (6684)	6689
		SOPORTE PARA MOTOR DERECHO	6686
		SOPORTE PARA MOTOR DERECHO	6802
		SOPORTE PARA TRANSMISIÓN	6685
		SOPORTE PARA MOTOR TRASERO	6694
		REPUESTO SOPORTES DE MOTOR IZQUIERDO Y DERECHO (6686, 6685, 6802 Y 6854)	1941
		SOPORTE PARA TRANSMISIÓN	6688
		SOPORTE PARA MOTOR DERECHO	6854
		SOPORTE PARA MOTOR DERECHO (16 VÁLVULAS)	6970
		REPUESTO PARA SOPORTE DE MOTOR DERECHO (16 VÁLVULAS) (6970)	6970-9

SOPORTES TRANSMISSION & MOTOR MOUNTS



1941



6684



6685



6686



6688



6689

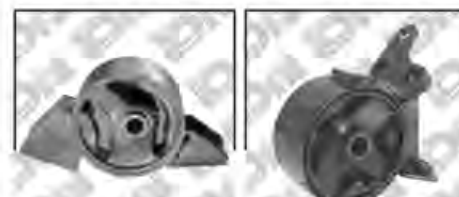

6694



6802

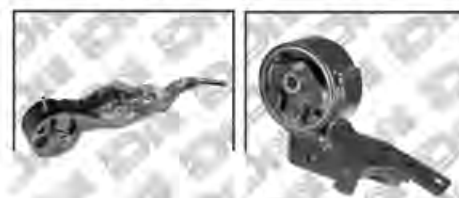

6824



6854



6970



6970-9



CONTINUACIÓN... TSURU III

28	APLICACIÓN / DESCRIPTION	DAI PARTS #	DAI KIT PARTS #
BASES PARA AMORTIGUADOR / STRUT MOUNTS			
92-16	BASE PARA AMORTIGUADOR FRONTAL IZQUIERDA Y DERECHA	6717	6717-KIT
	REPUESTO BASE DE AMORTIGUADOR FRONTAL IZQUIERDA Y DERECHA	6716	6716-KIT
	BASE PARA AMORTIGUADOR TRASERA IZQUIERDA Y DERECHA	6718	6718-KIT
	BALERO PARA BASE DE AMORTIGUADOR 6716-KIT, 7298-KIT, 7300-KIT, 6717-KIT Y 7026	6142	

6717-KIT

6718

6718-KIT
BASES PARA AMORTIGUADOR STRUT MOUNTS

6142

6716

6716-KIT

6717

28	APLICACIÓN / DESCRIPTION	DAI PARTS #
CUBRE POLVOS / C.V. BOOTS		
92-16	CUBRE POLVO IZQUIERDO Y DERECHO LADO CAJA (CON TRIPOIDE)	6310
	CUBRE POLVO IZQUIERDO Y DERECHO LADO RUEDA	6315
	CUBRE POLVO IZQUIERDO Y DERECHO LADO CAJA (CON TRIPOIDE)	6328
	CUBRE POLVO IZQUIERDO DE DIRECCIÓN	6335
	CUBRE POLVO DERECHO DE DIRECCIÓN	6336
	CUBRE POLVO IZQUIERDO Y DERECHO LADO RUEDA	6360

6328

6335

6336

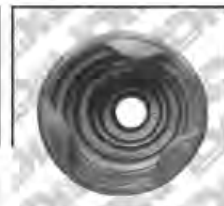

6360
CUBRE POLVOS C.V. BOOTS

6310

6310

6315

6328

CONTINUACIÓN... TSURU III

  28		APLICACIÓN / DESCRIPTION	DAI PARTS #
CUBRE POLVOS / C.V. BOOTS			
92-16		CUBRE POLVO IZQUIERDO Y DERECHO DE DIRECCIÓN HID.	6376
		CUBRE POLVO IZQUIERDO Y DERECHO LADO CAJA	6390
		CUBRE POLVO IZQUIERDO Y DERECHO LADO RUEDA	6397



MISCELÁNEOS / AUTOMOTIVE RUBBER PARTS			
92-16		TOPE PARA AMORTIGUADOR FRONTAL IZQUIERDO Y DERECHO (POLIURETANO)	D-0619
		GOMA SUJETARDORA PARA ESCAPE	FP06
		GOMA SUJETARDORA PARA ESCAPE	FP08
		GOMA PARA CAJA DE DIRECCIÓN DERECHA HID.	706
		GOMA PARA CREMALLERA DE DIRECCIÓN (DERECHA REFORZADA PAR 718)	707
		GOMA PARA CREMALLERA DE DIRECCIÓN HID. Y STD. (IZQUIERDA PAR 706 Y 707)	718
		TOPE PARA AMORTIGUADOR FRONTAL IZQUIERDO Y DERECHO (HULE)	2000
		TOPE PARA AMORTIGUADOR FRONTAL IZQUIERDO Y DERECHO (HULE)	2001
		TOPE PARA AMORTIGUADOR TRASERO IZQUIERDO Y DERECHO (HULE)	2003

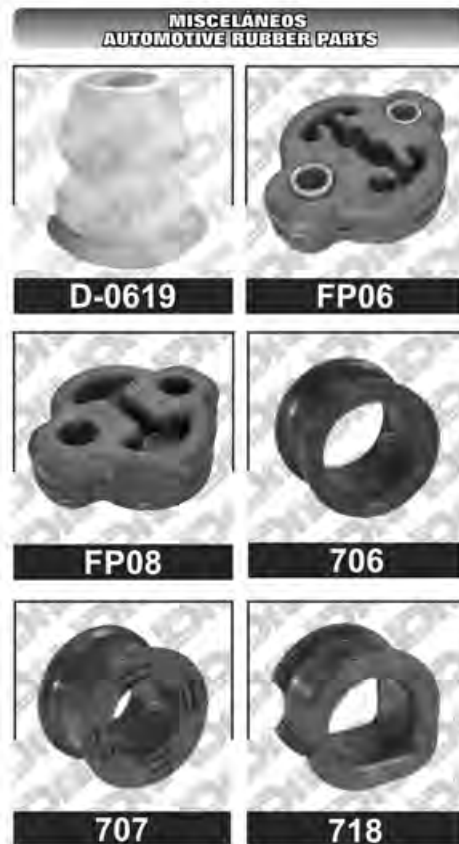

CONTINUACIÓN... TSURU III

	28	APLICACIÓN / DESCRIPTION	DAI PARTS #	MISCELÁNEOS / AUTOMOTIVE RUBBER PARTS	
--	----	--------------------------	-------------	---------------------------------------	--

MISCELÁNEOS / AUTOMOTIVE RUBBER PARTS			
	92-16	JUEGO DE GOMAS PARA BARRA ESTABILIZADORA TRASERA EN POLIURETANO	9813
		GOMAS PARA BARRA ESTABILIZADORA EN POLIURETANO (2 PIEZAS)	9812
		GOMA PARA BARRA ESTABILIZADORA	6417
		BUJES PARA HORQUILLA INFERIOR CHICO Y GRANDE (POLIURETANO KIT)	9801
		TORNILLO ESTABILIZADOR FRONTAL IZQUIERDO Y DERECHO	64620
		TORNILLO ESTABILIZADOR TRASERO IZQUIERDO Y DERECHO	64630
		REPUESTO PARA TORNILLOS ESTABILIZADORES (64620 Y 64630)	64640
		BUJE PARA HORQUILLA GRANDE (PUNTA)	64660
		BUJE PARA HORQUILLA CHICO	64670
		GOMA PARA BARRA ESTABILIZADORA	64680
		BUJE PARA ARTICULACIÓN TRASERA	DAI-55045-60Y00
	BUJE PARA TIRANTE TRASERO	DAI-55152-50A10	
92-17		GOMA O BUJE GRANDE PARA HORQUILLA INFERIOR	64661

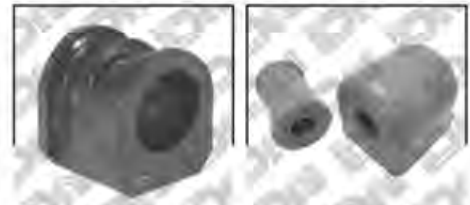

6417 **9801**



9812 **9813**

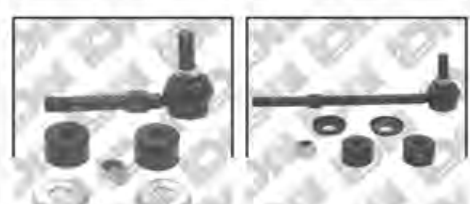

64620 **64630**



64640 **64660**



64661 **64670** **64680**



DAI-55045-60Y00 **DAI-55152-50A10**



URVAN

  28		APLICACIÓN / DESCRIPTION	DAI PARTS #
SOPORTES / TRANSMISSION & MOTOR MOUNTS			
L4 2.4	99-02	SOPORTE PARA TRANSMISIÓN	6994
		SOPORTE PARA MOTOR IZQUIERDO Y DERECHO	6995
	03-12	SOPORTE PARA MOTOR IZQUIERDO	6996
		SOPORTE PARA MOTOR DERECHO	7039
		REPUESTO SOPORTE DE TRANSMISIÓN	6997

L4 2.5	03-17	SOPORTE PARA TRANSMISIÓN GASOLINA (NV 350)	7447
		SOPORTE PARA TRANSMISIÓN DIESEL (NV 350)	7514
	13-17	SOPORTE PARA MOTOR IZQUIERDO DIESEL (NV-350)	7605
		SOPORTE PARA MOTOR DERECHO DIESEL (NV-350)	7606
		SOPORTE PARA MOTOR IZQUIERDO GASOLINA (NV-350)	7607
		SOPORTE PARA MOTOR DERECHO GASOLINA (NV-350)	7608

SOPORTES TRANSMISSION & MOTOR MOUNTS



6994 **6995**



6996 **6997**



7039 **7447**



CUBRE POLVOS / C.V. BOOTS		
03-17	CUBRE POLVO IZQUIERDO Y DERECHO DE DIRECCIÓN HID.	6367

CUBRE POLVOS C.V. BOOTS



6367



CONTINUACIÓN... URVAN

		APLICACIÓN / DESCRIPTION	DAI PARTS #	MISCELÁNEOS / AUTOMOTIVE RUBBER PARTS	
		REPUESTO DE GOMA PARA TORNILLO	64640		
99-02		TORNILLO ESTABILIZADOR	6109	6109	
		BUJE PARA MUELLE (POLIURETANO)	9130	9130	
03-12		TORNILLO ESTABILIZADOR DERECHO	64730		
		TORNILLO ESTABILIZADOR IZQUIERDO	64780	9210	
03-17		KIT DE BUJES PARA MUELLE TRASERO (POLIURETANO)	9804	9211	
		BUJE PARA HORQUILLA INFERIOR CHICO (POLIURETANO)	9210		
		BUJE PARA HORQUILLA INFERIOR GRANDE (POLIURETANO CON CEJA)	9211	9212	
		BUJE PARA HORQUILLA SUPERIOR (POLIURETANO)	9212	9804	
		GOMA PARA BARRA ESTABILIZADORA	64501		
		BUJE PARA MUELLE TRASERO	64790		
		BUJE PARA MUELLE TRASERO	64800		
	GOMA PARA BARRA ESTABILIZADORA (POLIURETANO)	94501			

64501

64730

64640

64780

64790

64800

94501

VAGONETA

		APLICACIÓN / DESCRIPTION	DAI PARTS #
SOPORTES / TRANSMISSION & MOTOR MOUNTS			
L4 1500 1600 1800	68-84	SOPORTE PARA MOTOR DERECHO	1717
		SOPORTE PARA MOTOR IZQUIERDO Y DERECHO	1785
		SOPORTE PARA TRANSMISIÓN STD.	1802
		SOPORTE PARA MOTOR IZQUIERDO Y DERECHO	1834



VARIOS

MISCELÁNEOS / AUTOMOTIVE RUBBER PARTS		
	GOMA PARA AMORTIGUADOR CÓNICA	34
	TOPE PARA SUSPENSIÓN TRASERA (BASE 90 X 68 mm ALT. 80 mm)	356
	GALLETAS PARA DIRECCIÓN STD. Y HID. (NO INCLUYE PERNOS NI BUJES)	628
	GOMA PARA HORQUILLA	6400
	BUJE PARA MUELLE (POLIURETANO)	9138
65-08	GALLETAS PARA DIRECCIÓN STD. (2 PERNOS DELGADOS COMPLETO 602, 610, 608 Y 614)	622



CONTINUACIÓN... VARIOS

 		APLICACIÓN / DESCRIPTION	DAI PARTS #
MISCELÁNEOS / AUTOMOTIVE RUBBER PARTS			
69-78		TOPE PARA SUSPENSIÓN TRASERA (BASE 45 X 70 mm ALT. 86 mm)	382
		GOMA PARA BARRA ESTABILIZADORA	6060
75-84		TOPE PARA SUSPENSIÓN TRASERA (BASE 167 X 68 mm ALT. 85 mm)	390
		TOPE PARA SUSPENSIÓN TRASERA (BASE 125 X 60 mm ALT. 55 mm)	392
79-84		GOMA PARA BARRA ESTABILIZADORA	6061

VERSA

SOPORTES / TRANSMISSION & MOTOR MOUNTS			
L4 1.6	11-17	SOPORTE PARA TRANSMISIÓN	7406
		SOPORTE PARA MOTOR TRASERO	7407
		SOPORTE PARA MOTOR DERECHO	7643-H
L4 1.8	09-11	SOPORTE PARA MOTOR TRASERO (USA)	7196
		SOPORTE PARA TRANSMISIÓN (USA)	7197
		SOPORTE PARA MOTOR DERECHO SUPERIOR (USA)	7203



CONTINUACIÓN... VERSA

28	APLICACIÓN / DESCRIPTION	DAI PARTS #	DAI KIT PARTS #
BASES PARA AMORTIGUADOR / STRUT MOUNTS			
09-11	BASE PARA AMORTIGUADOR FRONTAL DERECHA (USA)	7357	7357-KIT
	BASE PARA AMORTIGUADOR FRONTAL IZQUIERDA (USA)	7394	7394-KIT
11-17	BASE PARA AMORTIGUADOR FRONTAL IZQUIERDA Y DERECHA		7408-KIT



28	APLICACIÓN / DESCRIPTION	DAI PARTS #
CUBRE POLVOS / C.V. BOOTS		
11-17	CUBRE POLVO IZQUIERDO Y DERECHO LADO RUEDA	63144
	CUBRE POLVO IZQUIERDO Y DERECHO LADO CAJA (CON TRIPOIDE)	63145
	CUBRE POLVO IZQUIERDO Y DERECHO DE DIRECCIÓN	63146



CONTINUACIÓN... VERSA

 28		APLICACIÓN / DESCRIPTION	DAI PARTS #
MISCELÁNEOS / AUTOMOTIVE RUBBER PARTS			
09-11		GOMAS PARA BARRA ESTABILIZADORA EN POLIURETANO (2 PIEZAS)	9811
		BUJE PARA HORQUILLA INFERIOR GRANDE (USA)	DAI-1416009
09-17		TORNILLO ESTABILIZADOR FRONTAL (USA)	DAI-2116019
11-17		BUJE PARA HORQUILLA CHICO	DAI-1416042
		BUJE PARA HORQUILLA GRANDE	DAI-1416043

X-TERRA

SOPORTES / TRANSMISSION & MOTOR MOUNTS			
L4 2.4	00-04	SOPORTE PARA MOTOR IZQUIERDO Y DERECHO	6676
		SOPORTE PARA TRANSMISIÓN	7421
		SOPORTE PARA MOTOR IZQUIERDO Y DERECHO (ALTURA 56.23 MM)	7547
		SOPORTE PARA TRANSMISIÓN	7645
		SOPORTE PARA MOTOR IZQUIERDO Y DERECHO	7688





CONTINUACIÓN... X-TERRA

 		APLICACIÓN / DESCRIPTION	DAI PARTS #
SOPORTES / TRANSMISSION & MOTOR MOUNTS			
V6 3.3	00-04	SOPORTE PARA TRANSMISIÓN	7645
V6 4.0	05-15	SOPORTE PARA TRANSMISIÓN	7736



		APLICACIÓN / DESCRIPTION	DAI PARTS #	DAI KIT PARTS #
BASES PARA AMORTIGUADOR / STRUT MOUNTS				
05-15		BASE PARA AMORTIGUADOR FRONTAL IZQUIERDA Y DERECHA		7634-KIT



 		APLICACIÓN / DESCRIPTION	DAI PARTS #
MISCELÁNEOS / AUTOMOTIVE RUBBER PARTS			
	98-04	TORNILLO ESTABILIZADOR TRASERO	DAI-2116028





X-TRAIL

SOPORTES / TRANSMISSION & MOTOR MOUNTS			
L4 2.5	01-07	SOPORTE PARA MOTOR FRONTAL	7126
		SOPORTE PARA MOTOR DERECHO	7129



CONTINUACIÓN... X-TRAIL

  28		APLICACIÓN / DESCRIPTION	DAI PARTS #
SOPORTES / TRANSMISSION & MOTOR MOUNTS			
L4 2.5	01-07	SOPORTE PARA TRANSMISIÓN	7130
		SOPORTE PARA MOTOR TRASERO	7404
		REPUESTO PARA SOPORTE DE MOTOR TRASERO (4X4)	7430-9
	02-07	REPUESTO PARA SOPORTES DE MOTOR Y TRANSMISIÓN (7032, 7040 Y 7265)	7217-9
	08-13	SOPORTE PARA MOTOR DERECHO	7693-H
		SOPORTE PARA MOTOR DERECHO	7696
		SOPORTE PARA TRANSMISIÓN	7719-H
	08-14	SOPORTE PARA MOTOR DERECHO SUPERIOR (TORSIÓN)	7409
		SOPORTE PARA MOTOR TRASERO	7405
	14-17	SOPORTE PARA MOTOR DERECHO	7720-H
		SOPORTE PARA MOTOR TRASERO TORQUE STRUT	7721
		SOPORTE PARA MOTOR DERECHO SUPERIOR TORQUE STRUT	7722



 28		APLICACIÓN / DESCRIPTION	DAI PARTS #	DAI KIT PARTS #
BASES PARA AMORTIGUADOR / STRUT MOUNTS				
02-07		BASE PARA AMORTIGUADOR FRONTAL IZQUIERDA Y DERECHA		7300-KIT



CONTINUACIÓN... X-TRAIL

28	APLICACIÓN / DESCRIPTION	DAI PARTS #	DAI KIT PARTS #
BASES PARA AMORTIGUADOR / STRUT MOUNTS			
08-14	BASE PARA AMORTIGUADOR FRONTAL IZQUIERDA	7357	7357-KIT
	BASE PARA AMORTIGUADOR FRONTAL DERECHA	7394	7394-KIT
	BÁLERO PARA BASE DE AMORTIGUADOR FRONTAL IZQUIERDA Y DERECHA 7357, 7394, 7410-KIT Y 7411-KIT	6149	



28	APLICACIÓN / DESCRIPTION	DAI PARTS #
CUBRE POLVOS / C.V. BOOTS		
08-14	CUBRE POLVO IZQUIERDO Y DERECHO LADO RUEDA	63152
	CUBRE POLVO IZQUIERDO Y DERECHO LADO CAJA (CON TRIPOIDE)	63153
	CUBRE POLVO IZQUIERDO Y DERECHO LADO RUEDA	63173





CONTINUACIÓN... X-TRAIL

	 28	APLICACIÓN / DESCRIPTION	DAI PARTS #
MISCELÁNEOS / AUTOMOTIVE RUBBER PARTS			
02-07		TORNILLO ESTABILIZADOR FRONTAL IZQUIERDO	DAI-2116009
		TORNILLO ESTABILIZADOR FRONTAL DERECHO	DAI-2116010
		BUJE PARA HORQUILLA INFERIOR CHICO	DAI-1416023
08-15		BUJES PARA HORQUILLA (POLIURETANO KIT)	9806
		KIT DE BUJES PARA PUENTE Ó BASTIDOR (2 CHICOS Y 2 GRANDES)	64823



OLDSMOBILE

ACHIEVA

 		APLICACIÓN / DESCRIPTION	DAI PARTS #
SOPORTES / TRANSMISSION & MOTOR MOUNTS			
L4 2.3	92-95	REPUESTO SOPORTE PARA MOTOR DERECHO	6837-9
		REPUESTO SOPORTE PARA MOTOR DERECHO	6837-H
	1995	SOPORTE DE TORSIÓN FRONTAL DERECHO INFERIOR (BUJE LARGO 60.24 mm)	6936
	92-94	REPUESTO SOPORTE PARA TRANSMISIÓN FRONTAL STD.	7200
L4 2.4	96-98	REPUESTO SOPORTE PARA MOTOR DERECHO	6837-H
		REPUESTO SOPORTE PARA MOTOR DERECHO	6837-9
		SOPORTE DE TORSIÓN FRONTAL DERECHO INFERIOR (BUJE LARGO 60.24 mm)	6936
V6 3.1	94-98	REPUESTO SOPORTE PARA MOTOR DERECHO	6837-H
		REPUESTO SOPORTE PARA MOTOR DERECHO	6837-9
	95-98	REPUESTO SOPORTE PARA TRANSMISIÓN FRONTAL STD.	7200
V6 3.3	92-93	REPUESTO SOPORTE PARA MOTOR DERECHO	6837-9
		REPUESTO SOPORTE PARA MOTOR DERECHO	6837-H



		APLICACIÓN / DESCRIPTION	DAI PARTS #	DAI KIT PARTS #
BASES PARA AMORTIGUADOR / STRUT MOUNTS				
92-98		BASE PARA AMORTIGUADOR TRASERA IZQUIERDA Y DERECHA	1821	1821-KIT



CONTINUACIÓN... ACHIEVA

28	APLICACIÓN / DESCRIPTION	DAI PARTS #	DAI KIT PARTS #
BASES PARA AMORTIGUADOR / STRUT MOUNTS			
92-98	BASE PARA AMORTIGUADOR FRONTAL IZQUIERDA Y DERECHA	6731	6731-KIT



MISCELÁNEOS / AUTOMOTIVE RUBBER PARTS			
92-96	TORNILLO ESTABILIZADOR (7", 203.2 mm)	6102	
	TORNILLO ESTABILIZADOR (7", 203.2 mm EQUIPO ORIGINAL)	6106	
	GOMA PARA BARRA ESTABILIZADORA	6402	
	GOMA PARA BARRA ESTABILIZADORA	6403	

ALERO

SOPORTES / TRANSMISSION & MOTOR MOUNTS			
L4 2.2	02-04	SOPORTE PARA TRANSMISIÓN CENTRAL	6979
	05-06	SOPORTE PARA MOTOR DERECHO	7379-H



CONTINUACIÓN... ALERO

 		APLICACIÓN / DESCRIPTION	DAI PARTS #
SOPORTES / TRANSMISSION & MOTOR MOUNTS			
L4 2.2	02-04	REPUESTO SOPORTE PARA TRANSMISIÓN FRONTAL Y TRASERO	6985
		SOPORTE PARA TRANSMISIÓN (REPUESTO 6985)	7482
L4 2.4	99-01	SOPORTE PARA TRANSMISIÓN CENTRAL	6979
		REPUESTO SOPORTE PARA TRANSMISIÓN FRONTAL Y TRASERO	6985
		SOPORTE PARA TRANSMISIÓN (REPUESTO 6985)	7482
V6 3.4	99-04	SOPORTE PARA TRANSMISIÓN (REPUESTO 6985)	7482



MISCELÁNEOS / AUTOMOTIVE RUBBER PARTS			
	99-04	BUJES PARA HORQUILLA	DAI-K-6578



AURORA

 		APLICACIÓN / DESCRIPTION	DAI PARTS #	DAI KIT PARTS #
BASES PARA AMORTIGUADOR / STRUT MOUNTS				
95-96		BASE PARA AMORTIGUADOR TRASERA IZQUIERDA Y DERECHA	1821	1821-KIT



BRAVADA

	28	APLICACIÓN / DESCRIPTION	DAI PARTS #
--	----	--------------------------	-------------

SOPORTES / TRANSMISSION & MOTOR MOUNTS

L6 4.2	02-04	SOPORTE PARA MOTOR IZQUIERDO Y DERECHO	7244-H
		SOPORTE PARA TRANSMISIÓN AUT.	7311
V6 4.3	91-94	SOPORTE PARA TRANSMISIÓN AUT.	6874
	91-95	SOPORTE PARA MOTOR IZQUIERDO Y DERECHO	6873
	96-01	SOPORTE PARA MOTOR IZQUIERDO Y DERECHO	6914

6873
6874
6914
**SOPORTES
TRANSMISSION & MOTOR MOUNTS**

7244-H

7311

	28	APLICACIÓN / DESCRIPTION	DAI PARTS #	DAI KIT PARTS #
--	----	--------------------------	-------------	-----------------

BASES PARA AMORTIGUADOR / STRUT MOUNTS

02-04	BASE PARA AMORTIGUADOR FRONTAL IZQUIERDA Y DERECHA		7377-KIT
-------	--	--	----------

**BASES PARA AMORTIGUADOR
STRUT MOUNTS**

7377-KIT

	28	APLICACIÓN / DESCRIPTION	DAI PARTS #
--	----	--------------------------	-------------

MISCELÁNEOS / AUTOMOTIVE RUBBER PARTS

	83-04	BUJE DE HORQUILLA SUPERIOR (4X4)	DAI-K-6283
	02-08	BUJE PARA HORQUILLA SUPERIOR	DAI-1403010

**MISCELÁNEOS
AUTOMOTIVE RUBBER PARTS**

DAI-K-6283

DAI-1403010

CONTINUACIÓN... BRAVADA

 		APLICACIÓN / DESCRIPTION	DAI PARTS #
MISCELÁNEOS / AUTOMOTIVE RUBBER PARTS			
02-08		BUJE PARA HORQUILLA INFERIOR CHICO	DAI-1403013
		BUJE PARA HORQUILLA INFERIOR GRANDE	DAI-1403014
02-09		GOMA PARA BARRA ESTABILIZADORA	64712

**MISCELÁNEOS
AUTOMOTIVE RUBBER PARTS**



64712



DAI-1403013



DAI-1403014

CUTLASS CALAIS

SOportes / TRANSMISSION & MOTOR MOUNTS			
V6 3.8	78-79	SOPORTE PARA TRANSMISIÓN STD.	6766
V6 4.3		SOPORTE PARA TRANSMISIÓN (4X4)	6874

**SOportes
TRANSMISSION & MOTOR MOUNTS**



6766



6874

 		APLICACIÓN / DESCRIPTION	DAI PARTS #	DAI KIT PARTS #
BASES PARA AMORTIGUADOR / STRUT MOUNTS				
85-91		BASE PARA AMORTIGUADOR TRASERA IZQUIERDA Y DERECHA	1821	1821-KIT

**BASES PARA AMORTIGUADOR
STRUT MOUNTS**



1821



1821-KIT



CONTINUACIÓN... CUTLASS CALAIS

28		APLICACIÓN / DESCRIPTION	DAI PARTS #	DAI KIT PARTS #
BASES PARA AMORTIGUADOR / STRUT MOUNTS				
85-91		BASE PARA AMORTIGUADOR FRONTAL IZQUIERDA Y DERECHA	6710	6710-KIT

BASES PARA AMORTIGUADOR STRUT MOUNTS

6710

6710-KIT

28		APLICACIÓN / DESCRIPTION	DAI PARTS #
MISCELÁNEOS / AUTOMOTIVE RUBBER PARTS			
85-91		GOMA PARA BARRA ESTABILIZADORA	6402
		GOMA PARA BARRA ESTABILIZADORA	6403

MISCELÁNEOS AUTOMOTIVE RUBBER PARTS

6402

6403
CUTLASS CIERA

28		APLICACIÓN / DESCRIPTION	DAI PARTS #	DAI KIT PARTS #
BASES PARA AMORTIGUADOR / STRUT MOUNTS				
82-96		BASE PARA AMORTIGUADOR TRASERA IZQUIERDA Y DERECHA	1821	1821-KIT

BASES PARA AMORTIGUADOR STRUT MOUNTS

1821

1821-KIT
CUTLASS SUPREME

28		APLICACIÓN / DESCRIPTION	DAI PARTS #
SOPORTES / TRANSMISSION & MOTOR MOUNTS			
V6 3.1	97-99	SOPORTE PARA TRANSMISIÓN (REPUESTO 6985)	7482

SOPORTES TRANSMISSION & MOTOR MOUNTS

7482

CONTINUACIÓN... CUTLASS SUPREME

28	APLICACIÓN / DESCRIPTION	DAI PARTS #	DAI KIT PARTS #
BASES PARA AMORTIGUADOR / STRUT MOUNTS			
88-97	BASE PARA AMORTIGUADOR FRONTAL IZQUIERDA Y DERECHA	6720	6720-KIT
	BASE PARA AMORTIGUADOR TRASERA IZQUIERDA Y DERECHA	6735	6735-KIT



28	APLICACIÓN / DESCRIPTION	DAI PARTS #
MISCELÁNEOS / AUTOMOTIVE RUBBER PARTS		
88-97	TOPE PARA AMORTIGUADOR FRONTAL IZQUIERDO Y DERECHO	D-0622



DELTA 88 ROYALE

28	APLICACIÓN / DESCRIPTION	DAI PARTS #	DAI KIT PARTS #
BASES PARA AMORTIGUADOR / STRUT MOUNTS			
88-99	BASE PARA AMORTIGUADOR FRONTAL IZQUIERDA Y DERECHA	6726	6726-KIT
	BASE PARA AMORTIGUADOR TRASERA IZQUIERDA Y DERECHA	6732	6732-KIT



FIRENZA

28	APLICACIÓN / DESCRIPTION	DAI PARTS #	DAI KIT PARTS #
BASES PARA AMORTIGUADOR / STRUT MOUNTS			
82-84	BASE PARA AMORTIGUADOR TRASERA IZQUIERDA Y DERECHA	1821	1821-KIT
	BASE PARA AMORTIGUADOR FRONTAL IZQUIERDA Y DERECHA	6711	6711-KIT





28	APLICACIÓN / DESCRIPTION	DAI PARTS #
MISCELÁNEOS / AUTOMOTIVE RUBBER PARTS		
83-88	TOPE PARA AMORTIGUADOR FRONTAL IZQUIERDO Y DERECHO	D-0620
	GOMA PARA BARRA ESTABILIZADORA	6402
85-91	GOMA PARA BARRA ESTABILIZADORA	6403
	TORNILLO ESTABILIZADOR (7", 203.2 mm)	6102
	TORNILLO ESTABILIZADOR (7", 203.2 mm EQUIPO ORIGINAL)	6106



INTRIGUE

 		APLICACIÓN / DESCRIPTION	DAI PARTS #
SOPORTES / TRANSMISSION & MOTOR MOUNTS			
V6 3.5	99-02	SOPORTE PARA MOTOR TRASERO	7475
		SOPORTE PARA MOTOR FRONTAL	7483-H
V6 3.8	99-02	SOPORTE PARA MOTOR FRONTAL SUPERIOR IZQUIERDO Y DERECHO	7362



 		APLICACIÓN / DESCRIPTION	DAI PARTS #
MISCELÁNEOS / AUTOMOTIVE RUBBER PARTS			
	98-02	BUJE PARA HORQUILLA GRANDE	DAI-1403005
		BUJE PARA HORQUILLA CHICO	DAI-1403006



LSS

 	APLICACIÓN / DESCRIPTION	DAI PARTS #	DAI KIT PARTS #
BASES PARA AMORTIGUADOR / STRUT MOUNTS			
88-99	BASE PARA AMORTIGUADOR FRONTAL IZQUIERDA Y DERECHA	6726	6726-KIT



CONTINUACIÓN... LSS

28	APLICACIÓN / DESCRIPTION	DAI PARTS #	DAI KIT PARTS #
BASES PARA AMORTIGUADOR / STRUT MOUNTS			
88-99	BASE PARA AMORTIGUADOR TRASERA IZQUIERDA Y DERECHA	6732	6732-KIT

OMEGA

BASES PARA AMORTIGUADOR / STRUT MOUNTS			
80-84	BASE PARA AMORTIGUADOR TRASERA IZQUIERDA Y DERECHA	1821	1821-KIT
	BASE PARA AMORTIGUADOR FRONTAL IZQUIERDA Y DERECHA	6666	6666-KIT
	BASE PARA AMORTIGUADOR FRONTAL IZQUIERDA Y DERECHA	6667	6667-KIT



28	APLICACIÓN / DESCRIPTION	DAI PARTS #
MISCELÁNEOS / AUTOMOTIVE RUBBER PARTS		
80-84	TOPE PARA AMORTIGUADOR FRONTAL IZQUIERDO Y DERECHO	D-0620



SILHOUETTE

		APLICACIÓN / DESCRIPTION	DAI PARTS #		
SOPORTES / TRANSMISSION & MOTOR MOUNTS					
V6 3.1 V6 3.8	90-95	SOPORTE PARA TRANSMISIÓN TRASERO IZQUIERDO	1837		
		SOPORTE PARA TRANSMISIÓN FRONTAL IZQUIERDO	1839		
		SOPORTE DE TORSIÓN FRONTAL SUPERIOR	1864		
		SOPORTE PARA MOTOR DERECHO	1970		
		SOPORTE PARA MOTOR DERECHO	6633-H		
V6 3.4	1996	SOPORTE PARA TRANSMISIÓN TRASERO IZQUIERDO	1837		
		SOPORTE PARA TRANSMISIÓN FRONTAL IZQUIERDO	1838		
		SOPORTE PARA TRANSMISIÓN FRONTAL IZQUIERDO	1839		
		SOPORTE PARA MOTOR DERECHO	1970		
		SOPORTE PARA MOTOR DERECHO	6633-H		
	96-04	96-04	REPUESTO PARA SOPORTE DE TORSIÓN FRONTAL SUPERIOR IZQUIERDO Y DERECHO (7172)	7172-9	
			97-04	SOPORTE PARA MOTOR DERECHO	6838-H
				SOPORTE PARA TRANSMISIÓN	6844
				SOPORTE PARA MOTOR DERECHO	6875-H
				SOPORTE PARA MOTOR FRONTAL SUPERIOR IZQUIERDO Y DERECHO	7123



CONTINUACIÓN... SILHOUETTE

28	APLICACIÓN / DESCRIPTION	DAI PARTS #	DAI KIT PARTS #
BASES PARA AMORTIGUADOR / STRUT MOUNTS			
88-96	BASE PARA AMORTIGUADOR TRASERA IZQUIERDA Y DERECHA	1821	1821-KIT
	BASE PARA AMORTIGUADOR FRONTAL IZQUIERDA Y DERECHA	6666	6666-KIT
	BASE PARA AMORTIGUADOR FRONTAL IZQUIERDA Y DERECHA	6667	6667-KIT
97-04	BASE PARA AMORTIGUADOR FRONTAL IZQUIERDA Y DERECHA		7222-KIT

BASES PARA AMORTIGUADOR STRUT MOUNTS

1821
1821-KIT

6666
6666-KIT

6667
6667-KIT
7222-KIT

28	APLICACIÓN / DESCRIPTION	DAI PARTS #
MISCELÁNEOS / AUTOMOTIVE RUBBER PARTS		
90-96	TOPE PARA AMORTIGUADOR FRONTAL IZQUIERDO Y DERECHO	D-0620
97-04	BUJE PARA HORQUILLA GRANDE	DAI-1403005
	GOMA PARA BARRA ESTABILIZADORA	64721
	BUJE PARA HORQUILLA CHICO	DAI-1403006

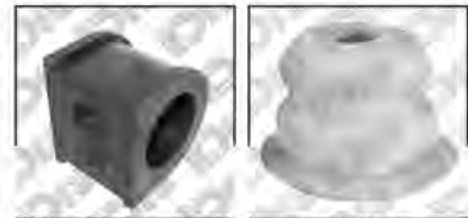
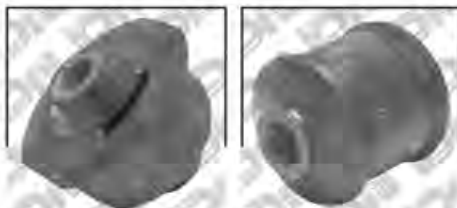
MISCELÁNEOS AUTOMOTIVE RUBBER PARTS

64721
D-0620

DAI-1403005
DAI-1403006



TORNADO

	APLICACIÓN / DESCRIPTION	DAI PARTS #	DAI KIT PARTS #
BASES PARA AMORTIGUADOR / STRUT MOUNTS			
86-92	BASE PARA AMORTIGUADOR TRASERA IZQUIERDA Y DERECHA	1821	1821-KIT



OPEL

RECKORD OLIMPIA

		APLICACIÓN / DESCRIPTION	DAI PARTS #
SOPORTES / TRANSMISSION & MOTOR MOUNTS			
L4	58-63	SOPORTE PARA MOTOR FRONTAL	1701



PEUGEOT

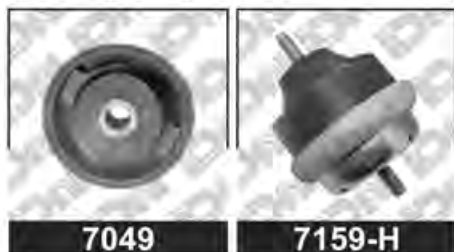

206

 		APLICACIÓN / DESCRIPTION	DAI PARTS #
SOPORTES / TRANSMISSION & MOTOR MOUNTS			
L4 1.4 L4 1.6	00-08	SOPORTE PARA MOTOR DERECHO (TROMPO CHICO AUT.) (SOLIDO)	7041
		SOPORTE PARA MOTOR DERECHO (TROMPO CHICO AUT.)	7041-H
		JUEGO DE LIMITADORES PARA SOPORTE (7041-H)	7041-9
		SOPORTE PARA TRANSMISIÓN	7042
		REPUESTO SOPORTE DE FLECHA TRASERA	7049
		SOPORTE PARA MOTOR DERECHO (TROMPO GRANDE)	7159-H



		APLICACIÓN / DESCRIPTION	DAI PARTS #	DAI KIT PARTS #
BASES PARA AMORTIGUADOR / STRUT MOUNTS				
99-08		BASE AMORTIGUADOR FRONTAL DERECHA		7375-KIT
		BASE AMORTIGUADOR FRONTAL IZQUIERDA		7376-KIT



 		APLICACIÓN / DESCRIPTION	DAI PARTS #
CUBRE POLVOS / C.V. BOOTS			
	99-08	CUBRE POLVO IZQUIERDO Y DERECHO LADO RUEDA	6378



CONTINUACIÓN... 206

		28	APLICACIÓN / DESCRIPTION	DAI PARTS #
CUBRE POLVOS / C.V. BOOTS				
	99-08		CUBRE POLVO IZQUIERDO Y DERECHO LADO CAJA (CON TRIPOIDE)	6332



MISCELÁNEOS / AUTOMOTIVE RUBBER PARTS				
	99-08		GOMA PARA BARRA ESTABILIZADORA	6436
			TORNILLO ESTABILIZADOR FRONTAL	DAI-2117001
			BUJE PARA HORQUILLA INFERIOR CHICO	DAI-352376
			BUJE PARA HORQUILLA INFERIOR GRANDE	DAI-352377

207

SOportes / TRANSMISSION & MOTOR MOUNTS				
L4 1.4 L4 1.6	09-11		SOPORTE PARA MOTOR DERECHO (TROMPO CHICO AUT.) (SOLIDO)	7041
			SOPORTE PARA TRANSMISIÓN SEDAN	7042



CONTINUACIÓN... 207

  28		APLICACIÓN / DESCRIPTION	DAI PARTS #
SOPORTES / TRANSMISSION & MOTOR MOUNTS			
L4 1.4 L4 1.6	09-11	REPUESTO PARA SOPORTE DE FLECHA TRASERA <i>SEDAN</i>	7049
		JUEGO DE LIMITADORES PARA SOPORTE (7041-H) <i>SEDAN</i>	7041-9
		JUEGO DE LIMITADORES PARA SOPORTE (7041-H) <i>COMPACT</i>	
		SOPORTE PARA MOTOR DERECHO (TROMPO CHICO AUT.) <i>SEDAN</i>	7041-H
		SOPORTE PARA MOTOR DERECHO (TROMPO CHICO AUT.) <i>COMPACT</i>	
		SOPORTE PARA MOTOR DERECHO (TROMPO GRANDE) <i>SEDAN</i>	7159-H
		SOPORTE PARA MOTOR DERECHO (TROMPO GRANDE) <i>COMPACT</i>	



MISCELÁNEOS / AUTOMOTIVE RUBBER PARTS

	08-11	BUJE PARA HORQUILLA INFERIOR CHICO <i>COMPACT</i>	DAI-352376
		BUJE PARA HORQUILLA INFERIOR GRANDE <i>COMPACT</i>	DAI-352377
	09-11	TORNILLO ESTABILIZADOR FRONTAL <i>COMPACT</i>	DAI-2117001



DAI-352377



306

  28		APLICACIÓN / DESCRIPTION	DAI PARTS #
SOPORTES / TRANSMISSION & MOTOR MOUNTS			
L4 1.6 L4 1.8 L4 2.0	97-02	REPUESTO SOPORTE DE FLECHA TRASERA	7049
		SOPORTE PARA MOTOR DERECHO TROMPO GRANDE	7159-H
		SOPORTE PARA TRANSMISIÓN	7161
		REPUESTO SOPORTE DE FLECHA TRASERA	7164



MISCELÁNEOS / AUTOMOTIVE RUBBER PARTS		
97-04	TORNILLO ESTABILIZADOR	DAI-2117003

307

SOPORTES / TRANSMISSION & MOTOR MOUNTS			
L4 2.0	03-12	SOPORTE PARA TRANSMISIÓN	7161
		SOPORTE PARA TRANSMISIÓN <i>SEDAN</i>	
		REPUESTO SOPORTE DE FLECHA TRASERA	7164
		REPUESTO SOPORTE DE FLECHA TRASERA <i>SEDAN</i>	



CONTINUACIÓN... 307

		APLICACIÓN / DESCRIPTION	DAI PARTS #
MISCELÁNEOS / AUTOMOTIVE RUBBER PARTS			
	04-08	BUJE PARA HORQUILLA INFERIOR GRANDE	DAI-352377
	04-12	TORNILLO ESTABILIZADOR FRONTAL	DAI-2117002



308

		MISCELÁNEOS / AUTOMOTIVE RUBBER PARTS	
MISCELÁNEOS / AUTOMOTIVE RUBBER PARTS			
	09-13	BUJE PARA HORQUILLA INFERIOR GRANDE	DAI-352377
		TORNILLO ESTABILIZADOR FRONTAL	DAI-2117002



405

		SOPORTES / TRANSMISSION & MOTOR MOUNTS	
SOPORTES / TRANSMISSION & MOTOR MOUNTS			
L4 2.0	97-00	SOPORTE PARA MOTOR DERECHO (TROMPO GRANDE)	7159-H
		SOPORTE PARA TRANSMISIÓN	7161
		REPUESTO SOPORTE DE FLECHA TRASERA	7164



406

  28		APLICACIÓN / DESCRIPTION	DAI PARTS #
SOPORTES / TRANSMISSION & MOTOR MOUNTS			
L4 2.0	00-05	SOPORTE PARA MOTOR DERECHO (TROMPO GRANDE)	7159-H
		REPUESTO SOPORTE DE FLECHA TRASERA	7164

407

SOPORTES / TRANSMISSION & MOTOR MOUNTS			
L4 2.2	04-10	SOPORTE PARA MOTOR DERECHO	7431-H



MISCELÁNEOS / AUTOMOTIVE RUBBER PARTS			
	06-09	TORNILLO ESTABILIZADOR TRASERO	DAI-2117007

605

SOPORTES / TRANSMISSION & MOTOR MOUNTS			
L4 2.9	02-08	SOPORTE PARA MOTOR DERECHO	7431-H



607

		APLICACIÓN / DESCRIPTION	DAI PARTS #
SOPORTES / TRANSMISSION & MOTOR MOUNTS			
V6 2.9	02-08	REPUESTO SOPORTE DE FLECHA TRASERA	7164



3008

MISCELÁNEOS / AUTOMOTIVE RUBBER PARTS			
	11-13	TORNILLO ESTABILIZADOR FRONTAL	DAI-2117002
		BUJE PARA HORQUILLA INFERIOR GRANDE	DAI-352377



FELINE

SOPORTES / TRANSMISSION & MOTOR MOUNTS			
L4 1.4 L4 1.6	00-09	SOPORTE PARA MOTOR DERECHO (TROMPO CHICO AUT.) (SOLIDO)	7041
		SOPORTE PARA MOTOR DERECHO (TROMPO CHICO AUT.)	7041-H
		JUEGO DE LIMITADORES PARA SOPORTE (7041-H)	7041-9
		SOPORTE PARA TRANSMISIÓN	7042
		REPUESTO SOPORTE DE FLECHA TRASERA	7049
		SOPORTE PARA MOTOR DERECHO (TROMPO GRANDE)	7159-H

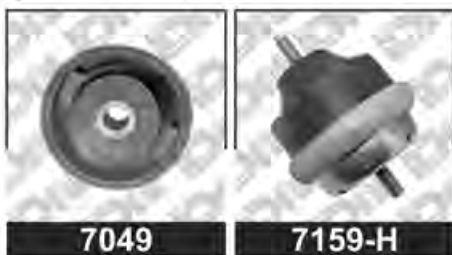

GRAND RAID

		APLICACIÓN / DESCRIPTION	DAI PARTS #
SOPORTES / TRANSMISSION & MOTOR MOUNTS			
L4 1.6	00-10	SOPORTE PARA MOTOR DERECHO (TROMPO CHICO AUT.) (SOLIDO)	7041
		SOPORTE PARA MOTOR DERECHO (TROMPO CHICO)	7041-H
		JUEGO DE LIMITADORES PARA SOPORTE (7041-H)	7041-9
00-07	SOPORTE PARA TRANSMISIÓN	7161	
	REPUESTO SOPORTE DE FLECHA TRASERA	7164	

PARTNER

		APLICACIÓN / DESCRIPTION	DAI PARTS #
SOPORTES / TRANSMISSION & MOTOR MOUNTS			
L4 1.6	00-10	SOPORTE PARA MOTOR DERECHO (TROMPO CHICO AUT.) (SOLIDO)	7041
		SOPORTE PARA MOTOR DERECHO (TROMPO CHICO)	7041-H
		JUEGO DE LIMITADORES PARA SOPORTE (7041-H)	7041-9
00-07	SOPORTE PARA TRANSMISIÓN	7161	
	REPUESTO SOPORTE DE FLECHA TRASERA	7164	



CONTINUACIÓN... PARTNER

			APLICACIÓN / DESCRIPTION	DAI PARTS #
MISCELÁNEOS / AUTOMOTIVE RUBBER PARTS				
			TORNILLO ESTABILIZADOR FRONTAL	DAI-2117002
	08-12		BUJE PARA HORQUILLA INFERIOR GRANDE <i>TEPEE</i>	DAI-352377



PLYMOUTH
BREEZE

28
APLICACIÓN / DESCRIPTION
**DAI
PARTS #**
SOPORTES / TRANSMISSION & MOTOR MOUNTS

L4 2.0	1996	SOPORTE PARA MOTOR DERECHO	6669
		REPUESTO PARA SOPORTE MOTOR DERECHO (6669)	6669-9
		REPUESTO PARA SOPORTE DE TRANSMISIÓN STD. Y AUT. (6670 Y 6671)	6763
		SOPORTE PARA TRANSMISIÓN AUT.	6770
		SOPORTE PARA TRANSMISIÓN STD.	6671
	97-00	REPUESTO PARA SOPORTE DE MOTOR FRONTAL (6698, 6900 Y 6901)	6787
		SOPORTE PARA MOTOR FRONTAL CON DISTANCIA ENTRE TUERCAS DE FIJACIÓN A 92 mm	6900
		SOPORTE PARA MOTOR FRONTAL CON DISTANCIA ENTRE TUERCAS DE FIJACIÓN A 76 mm	6901
		SOPORTE PARA TRANSMISIÓN	6849
	96-00	SOPORTE PARA MOTOR DERECHO	6851
REPUESTO PARA SOPORTE DE MOTOR TRASERO (6698 Y 6899)		6785	
SOPORTE PARA MOTOR TRASERO		6899	

**SOPORTES
TRANSMISSION & MOTOR MOUNTS**

6669

6669-9

6671

6763

6770

6785

6787

6849

6851

6899

6900

6901

CARAVELLE

28	APLICACIÓN / DESCRIPTION	DAI PARTS #	DAI KIT PARTS #
BASES PARA AMORTIGUADOR / STRUT MOUNTS			
83-88	BASE PARA AMORTIGUADOR DELANTERA IZQUIERDA Y DERECHA	6641	
	BASE PARA AMORTIGUADOR DELANTERA IZQUIERDA Y DERECHA		6758-KIT
	BALERO PARA BASES DE AMORTIGUADOR 6641 Y 6758-KIT	6141	

**BASES PARA AMORTIGUADOR
STRUT MOUNTS**



6141



6641



6758-KIT



721

IMPORTANTE: Identifica nuestro producto con el grabado del logo  No aceptes imitaciones.





A sheet of white paper with horizontal lines, resembling a notepad or a form for notes.



722

IMPORTANTE: Identifica nuestro producto con el grabado del logo  No aceptes imitaciones.



PONTIAC

6000

28	APLICACIÓN / DESCRIPTION	DAI PARTS #	DAI KIT PARTS #
BASES PARA AMORTIGUADOR / STRUT MOUNTS			
82-91	BASE PARA AMORTIGUADOR TRASERA IZQUIERDA Y DERECHA	1821	1821-KIT



AZTEK

28	APLICACIÓN / DESCRIPTION	DAI PARTS #	
SOPORTES / TRANSMISSION & MOTOR MOUNTS			
V6 3.4	01-05	SOPORTE PARA TRANSMISIÓN	6844
		SOPORTE PARA MOTOR FRONTAL SUPERIOR IZQUIERDO Y DERECHO	7123
		REPUESTO PARA SOPORTE DE TORSIÓN FRONTAL SUPERIOR IZQUIERDO Y DERECHO (7172)	7172-9
		SOPORTE PARA MOTOR DERECHO	7448-H



28	APLICACIÓN / DESCRIPTION	DAI PARTS #	DAI KIT PARTS #
BASES PARA AMORTIGUADOR / STRUT MOUNTS			
01-05	BASE PARA AMORTIGUADOR FRONTAL IZQUIERDA Y DERECHA		7222-KIT



CONTINUACIÓN... AZTEK

		APLICACIÓN / DESCRIPTION	DAI PARTS #
MISCELÁNEOS / AUTOMOTIVE RUBBER PARTS			
01-05		BUJE PARA HORQUILLA GRANDE	DAI-1403005
		BUJE PARA HORQUILLA CHICO	DAI-1403006

BONNEVILLE

SOPORTES / TRANSMISSION & MOTOR MOUNTS			
V6 3.8	80-86	SOPORTE PARA MOTOR IZQUIERDO	6772
		SOPORTE PARA TRANSMISIÓN	6770
	87-91	SOPORTE PARA TRANSMISIÓN FRONTAL IZQUIERDO	6779



		APLICACIÓN / DESCRIPTION	DAI PARTS #	DAI KIT PARTS #
BASES PARA AMORTIGUADOR / STRUT MOUNTS				
87-05		BASE PARA AMORTIGUADOR TRASERA IZQUIERDA Y DERECHA	1821	1821-KIT



CONTINUACIÓN... BONNEVILLE

28	APLICACIÓN / DESCRIPTION	DAI PARTS #	DAI KIT PARTS #
BASES PARA AMORTIGUADOR / STRUT MOUNTS			
87-99	BASE PARA AMORTIGUADOR FRONTAL IZQUIERDA Y DERECHA	6726	6726-KIT
	BASE PARA AMORTIGUADOR TRASERA IZQUIERDA Y DERECHA	6732	6732-KIT



6726

6726-KIT



6732

6732-KIT

28	APLICACIÓN / DESCRIPTION	DAI PARTS #
MISCELÁNEOS / AUTOMOTIVE RUBBER PARTS		
87-99	TOPE PARA AMORTIGUADOR FRONTAL IZQUIERDO Y DERECHO	D-0620



D-0620

FIREBIRD

SOPORTES / TRANSMISSION & MOTOR MOUNTS			
L4 2.5	82-86	SOPORTE PARA TRANSMISIÓN	1911
		SOPORTE PARA TRANSMISIÓN	1940
		SOPORTE PARA MOTOR IZQUIERDO	6909
		SOPORTE PARA MOTOR DERECHO	6983



6909

6983



1911

1940



CONTINUACIÓN... FIREBIRD

			APLICACIÓN / DESCRIPTION	DAI PARTS #
SOPORTES / TRANSMISSION & MOTOR MOUNTS				
V6 2.8	82-83	SOPORTE PARA TRANSMISIÓN STD. (5 VEL.)		6774
	82-89	SOPORTE PARA MOTOR IZQUIERDO Y DERECHO		6640
	84-87	SOPORTE PARA TRANSMISIÓN		1911
		SOPORTE PARA TRANSMISIÓN		1940
	84-89	SOPORTE PARA TRANSMISIÓN		1757
V6 3.1	90-92	SOPORTE PARA MOTOR IZQUIERDO Y DERECHO		6640
		SOPORTE PARA TRANSMISIÓN		6792
V6 3.2	76-87	SOPORTE PARA TRANSMISIÓN		6916
V6 3.4	93-95	SOPORTE PARA MOTOR IZQUIERDO Y DERECHO		6640
		SOPORTE PARA TRANSMISIÓN		7469-H
V6 3.8	77-78	SOPORTE PARA MOTOR IZQUIERDO		6790
	77-81	SOPORTE PARA MOTOR DERECHO		6791
	95-02	SOPORTE PARA TRANSMISIÓN		7469-H
	96-02	SOPORTE PARA MOTOR IZQUIERDO Y DERECHO		6640
V8 5.7	98-02	SOPORTE PARA TRANSMISIÓN		7513

**SOPORTES
TRANSMISSION & MOTOR MOUNTS**

1757

1911

1940

6640

6774

6790

6791

6792

6916

7469-H

7513

CONTINUACIÓN... FIREBIRD

	APLICACIÓN / DESCRIPTION	DAI PARTS #	DAI KIT PARTS #
BASES PARA AMORTIGUADOR / STRUT MOUNTS			
82-92	BASE PARA AMORTIGUADOR FRONTAL DERECHA	6727	6727-KIT
	BASE PARA AMORTIGUADOR FRONTAL IZQUIERDA	6728	6728-KIT
93-02	BASE PARA AMORTIGUADOR FRONTAL DERECHA	6751	6751-KIT
	BASE PARA AMORTIGUADOR FRONTAL IZQUIERDA	6761	6761-KIT

**BASES PARA AMORTIGUADOR
STRUT MOUNTS**



6727 6727-KIT



6728 6728-KIT



6751 6751-KIT 6761 6761-KIT

	APLICACIÓN / DESCRIPTION	DAI PARTS #
MISCELÁNEOS / AUTOMOTIVE RUBBER PARTS		
82-92	TORNILLO ESTABILIZADOR (6", 177.8 mm)	6101
	TORNILLO ESTABILIZADOR (6", 177.8 mm EQUIPO ORIGINAL)	6105
93-02	TORNILLO ESTABILIZADOR (7", 203.2 mm)	6102
	TORNILLO ESTABILIZADOR (7", 203.2 mm EQUIPO ORIGINAL)	6106

**MISCELÁNEOS
AUTOMOTIVE RUBBER PARTS**

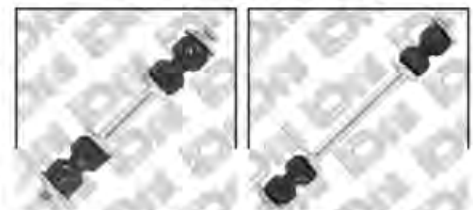

6101 6102

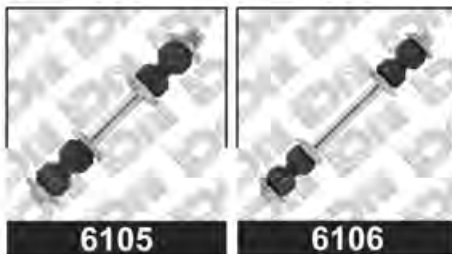

6105 6106



FIRETY CANADIAN

28	APLICACIÓN / DESCRIPTION	DAI PARTS #	DAI KIT PARTS #
BASES PARA AMORTIGUADOR / STRUT MOUNTS			
89-01	BASE PARA AMORTIGUADOR TRASERA IZQUIERDA Y DERECHA	1821	1821-KIT

G3

	28	APLICACIÓN / DESCRIPTION	DAI PARTS #
SOportes / TRANSMISSION & MOTOR MOUNTS			
L4 1.6	06-10	SOORTE PARA TRANSMISIÓN STD. Y AUT.	7258
		REPUESTO PARA SOORTE DE TRANSMISIÓN STD. Y AUT. (7358)	7258-9
		SOORTE PARA MOTOR DERECHO	7259
		REPUESTO PARA SOORTE DE MOTOR DERECHO (7259)	7259-9
		SOORTE PARA MOTOR TRASERO	7260
		REPUESTO PARA SOORTE DE MOTOR TRASERO (7260)	7260-9





28	APLICACIÓN / DESCRIPTION	DAI PARTS #	DAI KIT PARTS #
BASES PARA AMORTIGUADOR / STRUT MOUNTS			
06-10	BASE PARA AMORTIGUADOR TRASERA IZQUIERDA Y DERECHA		7284-KIT
	BASE PARA AMORTIGUADOR FRONTAL IZQUIERDA Y DERECHA		7294-KIT



CONTINUACIÓN... G3

 		APLICACIÓN / DESCRIPTION	DAI PARTS #
CUBRE POLVOS / C.V. BOOTS			
L4 1.6	06-10	CUBRE POLVO IZQUIERDO Y DERECHO LADO RUEDA	63138
		CUBRE POLVO IZQUIERDO Y DERECHO LADO CAJA	63139
		CUBRE POLVO IZQUIERDO Y DERECHO DE DIRECCIÓN	63140
		CUBRE POLVO IZQUIERDO Y DERECHO LADO CAJA (CON TRIPOIDE)	63171



 		APLICACIÓN / DESCRIPTION	DAI PARTS #
MISCELÁNEOS / AUTOMOTIVE RUBBER PARTS			
	06-10	BUJES PARA HORQUILLA (POLIURETANO KIT)	9805
		BUJE PARA HORQUILLA INFERIOR GRANDE	DAI-1403023
		BUJE PARA HORQUILLA INFERIOR CHICO	DAI-1403024



G4

28		APLICACIÓN / DESCRIPTION	DAI PARTS #	DAI KIT PARTS #
BASES PARA AMORTIGUADOR / STRUT MOUNTS				
05-09		BASE PARA AMORTIGUADOR FRONTAL IZQUIERDA Y DERECHA		7636-KIT

**BASES PARA AMORTIGUADOR
STRUT MOUNTS**

7636-KIT

28		APLICACIÓN / DESCRIPTION	DAI PARTS #
MISCELÁNEOS / AUTOMOTIVE RUBBER PARTS			
05-06		TORNILLO ESTABILIZADOR FRONTAL	DAI-2103001

**MISCELÁNEOS
AUTOMOTIVE RUBBER PARTS**

DAI-2103001
G5

SOPORTES / TRANSMISSION & MOTOR MOUNTS			
L4 2.2	07-09	SOPORTE PARA MOTOR TRASERO	7233
		SOPORTE PARA MOTOR FRONTAL	7234
		SOPORTE PARA MOTOR DERECHO STD.	7471-H
		SOPORTE PARA MOTOR DERECHO AUT.	7472-H
L4 2.4	07-08	SOPORTE PARA MOTOR DERECHO STD.	7471-H
		SOPORTE PARA MOTOR DERECHO AUT.	7472-H

**SOPORTES
TRANSMISSION & MOTOR MOUNTS**

7233

7234

7471-H

7472-H

CONTINUACIÓN... G5

 28	APLICACIÓN / DESCRIPTION	DAI PARTS #	DAI KIT PARTS #
BASES PARA AMORTIGUADOR / STRUT MOUNTS			
07-09	BASE PARA AMORTIGUADOR FRONTAL IZQUIERDA Y DERECHA		7636-KIT



 28	APLICACIÓN / DESCRIPTION	DAI PARTS #
MISCELÁNEOS / AUTOMOTIVE RUBBER PARTS		
07-09	TORNILLO ESTABILIZADOR FRONTAL	DAI-2103001



G6

SOPORTES / TRANSMISSION & MOTOR MOUNTS			
L4 2.4	2009	SOPORTE PARA MOTOR DERECHO	7510-H
	06-07	SOPORTE PARA TRANSMISIÓN	7655
	08-10	SOPORTE PARA MOTOR FRONTAL (T. MANUAL)	7603
V6 3.5	06-08	SOPORTE PARA MOTOR FRONTAL	7400
	05-07	SOPORTE PARA TRANSMISIÓN	7655
	05-08	SOPORTE PARA TRANSMISIÓN	7562-H
	05-09	SOPORTE PARA MOTOR DERECHO	7563-H
V6 3.9	05-07	SOPORTE PARA TRANSMISIÓN	7655
	06-08	SOPORTE PARA MOTOR FRONTAL	7400



CONTINUACIÓN... G6

 		APLICACIÓN / DESCRIPTION	DAI PARTS #
SOPORTES / TRANSMISSION & MOTOR MOUNTS			
V6 3.9	06-08	SOPORTE PARA MOTOR DERECHO	7563-H
	2007	SOPORTE PARA TRANSMISIÓN	7562-H





MISCELÁNEOS / AUTOMOTIVE RUBBER PARTS			
	06-10	BUJE PARA HORQUILLA INFERIOR CHICO	DAI-352364
		TORNILLO ESTABILIZADOR FRONTAL	DAI-2103001

GRAND AM

SOPORTES / TRANSMISSION & MOTOR MOUNTS			
L4 2.0	87-89	SOPORTE PARA MOTOR FRONTAL DERECHO	1971
		SOPORTE PARA MOTOR FRONTAL DERECHO	1972
		SOPORTE PARA MOTOR TRASERO	1980
		SOPORTE PARA MOTOR TRASERO	6795
		SOPORTE DE TORSIÓN TRASERO	1909
		SOPORTE DE TORSIÓN TRASERO	6647
		REPUESTO PARA SOPORTE DE TRANSMISIÓN (6655)	6642
		SOPORTE PARA TRANSMISIÓN	6655



CONTINUACIÓN... GRAND AM

 		APLICACIÓN / DESCRIPTION	DAI PARTS #
SOPORTES / TRANSMISSION & MOTOR MOUNTS			
L4 2.2	02-05	SOPORTE PARA TRANSMISIÓN CENTRAL	6979
		REPUESTO SOPORTE FRONTAL Y TRASERO DE TRANSMISIÓN	6985
		SOPORTE PARA TRANSMISIÓN	7482
L4 2.3	88-91	SOPORTE DE TORSIÓN TRASERO	1909
	92-95	REPUESTO SOPORTE PARA MOTOR DERECHO	6837-9
		REPUESTO SOPORTE PARA MOTOR DERECHO	6837-H
		SOPORTE DE TORSIÓN FRONTAL DERECHO INFERIOR (BUJE LARGO 60.24 mm)	6936
		REPUESTO SOPORTE PARA TRANSMISIÓN FRONTAL STD. (5 VEL.)	7200
		REPUESTO SOPORTE PARA TRANSMISIÓN TRASERO STD. (5 VEL.)	7312
L4 2.4	96-98	REPUESTO SOPORTE PARA MOTOR DERECHO	6837-9
		REPUESTO SOPORTE PARA MOTOR DERECHO	6837-H
		SOPORTE DETORSIÓN FRONTAL DERECHO INFERIOR (BUJE LARGO 60.24 mm)	6936
	99-01	REPUESTO SOPORTES FRONTAL Y TRASERO DE TRANSMISIÓN	6985
		SOPORTE PARA TRANSMISIÓN	7482
L4 2.5	85-91	SOPORTE PARA MOTOR FRONTAL DERECHO	1971
		SOPORTE PARA MOTOR FRONTAL DERECHO	1972
L4 2.5 V6 3.0	85-91	SOPORTE PARA MOTOR TRASERO	1980
		SOPORTE PARA MOTOR TRASERO	6795

SOPORTES TRANSMISSION & MOTOR MOUNTS

	
1909	1971
	
1972	1980
	
6795	6837-H
	
6837-9	6936
	
6979	6985

		
7200	7312	7482



CONTINUACIÓN... GRAND AM

 		APLICACIÓN / DESCRIPTION	DAI PARTS #	SOPORTES TRANSMISIÓN & MOTOR MOUNTS	
L4 2.5 V6 3.0	85-91	SOPORTE DE TORSIÓN TRASERO	1909		
		SOPORTE PARA TRANSMISIÓN	6655		
		REPUESTO PARA SOPORTE DE TRANSMISIÓN (6655)	6642		
V6 3.0	86-87	SOPORTE PARA MOTOR DERECHO	6872		
V6 3.1	94-98	REPUESTO SOPORTE PARA MOTOR DERECHO	6837-9		
		REPUESTO SOPORTE PARA MOTOR DERECHO	6837-H		
	95-98	SOPORTE DE TORSIÓN FRONTAL DERECHO INFERIOR (BUJE LARGO 60.24 mm)	6936		
V6 3.3	92-93	REPUESTO SOPORTE PARA MOTOR DERECHO	6837-9		
		REPUESTO SOPORTE PARA MOTOR DERECHO	6837-H		
V6 3.4	99-05	SOPORTE PARA TRANSMISIÓN (REPUESTO 6985)	7482		
		REPUESTO SOPORTE FRONTAL Y TRASERO DE TRANSMISIÓN	6985		
		SOPORTE PARA TRANSMISIÓN CENTRAL	6979		
					
				6936	6979
				6985	7482



CONTINUACIÓN... GRAND AM

	APLICACIÓN / DESCRIPTION	DAI PARTS #	DAI KIT PARTS #
BASES PARA AMORTIGUADOR / STRUT MOUNTS			
82-94	BASE PARA AMORTIGUADOR FRONTAL IZQUIERDA Y DERECHA	6711	6711-KIT
85-98	BASE PARA AMORTIGUADOR IZQUIERDA Y DERECHA	6731	6731-KIT
85-05	BASE PARA AMORTIGUADOR TRASERA IZQUIERDA Y DERECHA	1821	1821-KIT
99-05	BASE PARA AMORTIGUADOR TRASERA IZQUIERDA Y DERECHA		6986-KIT
	BASE PARA AMORTIGUADOR TRASERA IZQUIERDA Y DERECHA		7328-KIT

BASES PARA AMORTIGUADOR STRUT MOUNTS



1821 1821-KIT

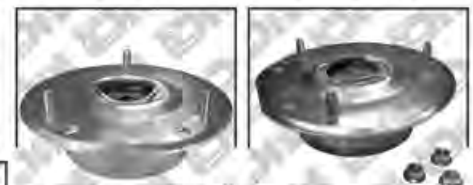

6711 6711-KIT



6731 6731-KIT 6986-KIT 7328-KIT

	APLICACIÓN / DESCRIPTION	DAI PARTS #
MISCELÁNEOS / AUTOMOTIVE RUBBER PARTS		
85-96	TOPE PARA AMORTIGUADOR FRONTAL IZQUIERDO Y DERECHO	D-0620
85-98	TORNILLO ESTABILIZADOR (7", 203.200 mm)	6102
	TORNILLO ESTABILIZADOR (7", 203.200 mm EQUIPO ORIGINAL)	6106
92-98	TOPE PARA AMORTIGUADOR FRONTAL TRASERO IZQUIERDO Y DERECHO	D-0621
99-05	TOPE PARA AMORTIGUADOR TRASERO IZQUIERDO Y DERECHO	D-0619

MISCELÁNEOS AUTOMOTIVE RUBBER PARTS

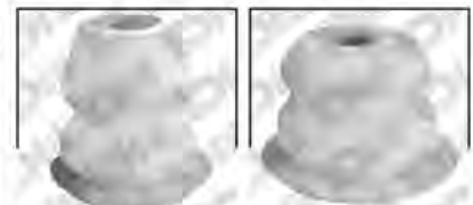

D-0619 D-0620



D-0621 6102 6106



735
IMPORTANTE: Identifica nuestro producto con el grabado del logo  No aceptes imitaciones.



CONTINUACIÓN... GRAND AM

		APLICACIÓN / DESCRIPTION	DAI PARTS #
MISCELÁNEOS / AUTOMOTIVE RUBBER PARTS			
99-05	BUJES PARA HORQUILLA		DAI-K-6578
	GOMA PARA BARRA ESTABILIZADORA 5/8"		64697
	GOMA PARA BARRA ESTABILIZADORA		6404



DAI-K-6578

GRAND PRIX



SOPORTES / TRANSMISSION & MOTOR MOUNTS			
L4 2.3	90-91	SOPORTE DE TORSIÓN FRONTAL SUPERIOR	1864
		SOPORTE PARA TRANSMISIÓN AUT.	6920
L4 2.8	88-89	SOPORTE PARA MOTOR DERECHO	6875-H
		SOPORTE DE TORSIÓN FRONTAL SUPERIOR	6781
		SOPORTE PARA TRANSMISIÓN AUT.	6920
V6 3.1	89-03	SOPORTE PARA MOTOR DERECHO	6875-H
	89-94	SOPORTE DE TORSIÓN FRONTAL SUPERIOR	6781
	89-93	SOPORTE PARA TRANSMISIÓN AUT.	6920
	94-03	SOPORTE PARA MOTOR FRONTAL SUPERIOR IZQUIERDO Y DERECHO	7166



7166



CONTINUACIÓN... GRAND PRIX

		APLICACIÓN / DESCRIPTION	DAI PARTS #
SOPORTES / TRANSMISSION & MOTOR MOUNTS			
V6 3.1	94-03	REPUESTO PARA SOPORTE DE TORSIÓN FRONTAL SUPERIOR IZQ. Y DER. (7172)	7172-9
		SOPORTE PARA TRANSMISIÓN	7239-H
V6 3.4	91-96	SOPORTE PARA MOTOR DERECHO	6918-H
	91-95	SOPORTE PARA TRANSMISIÓN	7239-H
	92-93	SOPORTE PARA TRANSMISIÓN	6844
		SOPORTE PARA TRANSMISIÓN AUT.	6920
V6 3.8	97-07	SOPORTE PARA MOTOR DERECHO	6875-H
		REPUESTO PARA SOPORTE DE TORSIÓN FRONTAL SUPERIOR IZQ. Y DER. (7172)	7172-9
		SOPORTE PARA TRANSMISIÓN	7239-H
	97-08	SOPORTE PARA MOTOR FRONTAL SUPERIOR IZQUIERDO Y DERECHO	7362
	06-07	SOPORTE PARA TRANSMISIÓN	6844
V8 5.3	05-08	SOPORTE PARA MOTOR FRONTAL SUPERIOR IZQUIERDO Y DERECHO	7362
		REPUESTO PARA SOPORTE DE TORSIÓN FRONTAL SUPERIOR IZQ. Y DER. (7172)	7172-9
		SOPORTE PARA MOTOR FRONTAL	7483-H
		SOPORTE PARA MOTOR TRASERO	7475



CONTINUACIÓN... GRAND PRIX

28	APLICACIÓN / DESCRIPTION	DAI PARTS #	DAI KIT PARTS #
BASES PARA AMORTIGUADOR / STRUT MOUNTS			
88-96	BASE PARA AMORTIGUADOR FRONTAL IZQUIERDA Y DERECHA	6720	6720-KIT
	BASE PARA AMORTIGUADOR TRASERA IZQUIERDA Y DERECHA	6735	6735-KIT
97-07	BASE PARA AMORTIGUADOR TRASERA IZQUIERDA		7285-KIT
	BASE PARA AMORTIGUADOR TRASERA DERECHA		7296-KIT
97-08	BASE PARA AMORTIGUADOR FRONTAL IZQUIERDA Y DERECHA		7222-KIT



28	APLICACIÓN / DESCRIPTION	DAI PARTS #
MISCELÁNEOS / AUTOMOTIVE RUBBER PARTS		
85-96	TOPE PARA AMORTIGUADOR FRONTAL IZQUIERDO Y DERECHO	D-0620
97-02	TORNILLO ESTABILIZADOR (7", 203.2 mm)	6102
	TORNILLO ESTABILIZADOR (7", 203.2 mm EQUIPO ORIGINAL)	6106
97-08	BUJE PARA HORQUILLA GRANDE	DAI-1403005
	BUJE PARA HORQUILLA CHICO	DAI-1403006
04-08	TORNILLO ESTABILIZADOR	DAI-15851956

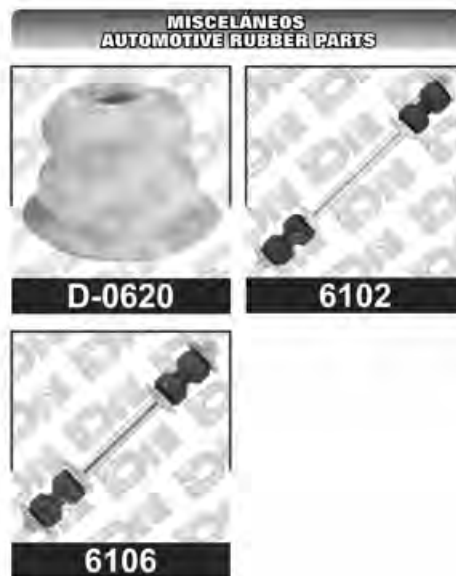

MONTANA

		APLICACIÓN / DESCRIPTION	DAI PARTS #
SOPORTES / TRANSMISSION & MOTOR MOUNTS			
V6 3.4	99-05	SOPORTE PARA MOTOR FRONTAL SUPERIOR IZQUIERDO Y DERECHO	7123
		SOPORTE PARA TRANSMISIÓN	6844
V6 3.4	99-05	REPUESTO PARA SOPORTE DE TORSIÓN FRONTAL SUPERIOR IZQ. Y DER. (7172)	7172-9
V6 3.5		SOPORTE PARA MOTOR DERECHO	6838-H
V6 3.9		SOPORTE PARA MOTOR DERECHO	6875-H
V6 3.5	99-05	SOPORTE PARA MOTOR FRONTAL SUPERIOR IZQUIERDO Y DERECHO	7123
		SOPORTE PARA TRANSMISIÓN	6844

SOPORTES TRANSMISSION & MOTOR MOUNTS



6838-H



6844



6875-H



7123



	APLICACIÓN / DESCRIPTION	DAI PARTS #	DAI KIT PARTS #
BASES PARA AMORTIGUADOR / STRUT MOUNTS			
99-07	BASE PARA AMORTIGUADOR FRONTAL IZQUIERDA Y DERECHA		7222-KIT

BASES PARA AMORTIGUADOR STRUT MOUNTS



7222-KIT

		APLICACIÓN / DESCRIPTION	DAI PARTS #
MISCELÁNEOS / AUTOMOTIVE RUBBER PARTS			
	99-07	BUJE PARA HORQUILLA GRANDE	DAI-1403005
		BUJE PARA HORQUILLA CHICO	DAI-1403006

MISCELÁNEOS AUTOMOTIVE RUBBER PARTS



DAI-1403005



DAI-1403006



CONTINUACIÓN... MONTANA

		APLICACIÓN / DESCRIPTION	DAI PARTS #
MISCELÁNEOS / AUTOMOTIVE RUBBER PARTS			
	99-07	GOMA PARA BARRA ESTABILIZADORA	64721
	05-07	TORNILLO ESTABILIZADOR	DAI-15851956

PHOENIX

	APLICACIÓN / DESCRIPTION	DAI PARTS #	DAI KIT PARTS #
BASES PARA AMORTIGUADOR / STRUT MOUNTS			
82-84	BASE PARA AMORTIGUADOR TRASERA IZQUIERDA Y DERECHA	1821	1821-KIT
	BASE PARA AMORTIGUADOR FRONTAL IZQUIERDA Y DERECHA	6666	6666-KIT
	BASE PARA AMORTIGUADOR FRONTAL IZQUIERDA Y DERECHA	6667	6667-KIT

PURSUIT

BASES PARA AMORTIGUADOR / STRUT MOUNTS			
05-06	BASE PARA AMORTIGUADOR FRONTAL IZQUIERDA Y DERECHA		7636-KIT



SUNBIRD

28	APLICACIÓN / DESCRIPTION	DAI PARTS #	DAI KIT PARTS #
BASES PARA AMORTIGUADOR / STRUT MOUNTS			
82-94	BASE PARA AMORTIGUADOR TRASERA IZQUIERDA Y DERECHA	1821	1821-KIT
	BASE PARA AMORTIGUADOR FRONTAL IZQUIERDA Y DERECHA	6711	6711-KIT



SUNFIRE

28	APLICACIÓN / DESCRIPTION	DAI PARTS #	
SOPORTES / TRANSMISSION & MOTOR MOUNTS			
L4 2.2 L4 2.3 L4 2.4	95-05	SOPORTE DE TORSIÓN FRONTAL DERECHO INFERIOR (BUJE LARGO 60.24 mm)	6936
		REPUESTO SOPORTE PARA MOTOR DERECHO	6837-9
		REPUESTO SOPORTE PARA MOTOR DERECHO	6837-H
		SOPORTE PARA TRANSMISIÓN AUT.	6843
		REPUESTO SOPORTE PARA TRANSMISIÓN FRONTAL STD., 5 VEL.	7200
		REPUESTO SOPORTE PARA TRANSMISIÓN TRASERO STD., 5 VEL.	7312
02-05	SOPORTE PARA MOTOR DERECHO	7278-H	



CONTINUACIÓN... SUNFIRE

28	APLICACIÓN / DESCRIPTION	DAI PARTS #	DAI KIT PARTS #
BASES PARA AMORTIGUADOR / STRUT MOUNTS			
95-05	BASE PARA AMORTIGUADOR FRONTAL IZQUIERDA Y DERECHA	6731	6731-KIT
	BASE PARA AMORTIGUADOR TRASERA IZQUIERDA Y DERECHA	6752	6752-KIT
	BASE PARA AMORTIGUADOR FRONTAL IZQUIERDA Y DERECHA		6986-KIT



28	APLICACIÓN / DESCRIPTION	DAI PARTS #
CUBRE POLVOS / C.V. BOOTS		
95-05	CUBRE POLVO IZQUIERDO Y DERECHO LADO RUEDA	6378



MISCELÁNEOS / AUTOMOTIVE RUBBER PARTS			
82-94	TORNILLO ESTABILIZADOR (6", 177.8 mm)	6101	
	TORNILLO ESTABILIZADOR (7", 203.2 mm)	6102	
	TORNILLO ESTABILIZADOR (6", 177.8 mm EQUIPO ORIGINAL)	6105	

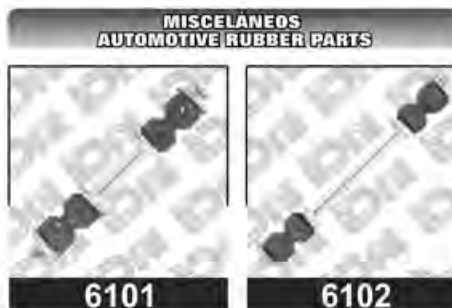

CONTINUACIÓN... SUNFIRE

 		APLICACIÓN / DESCRIPTION	DAI PARTS #
MISCELÁNEOS / AUTOMOTIVE RUBBER PARTS			
82-94		TORNILLO ESTABILIZADOR (7", 203.2 mm EQUIPO ORIGINAL)	6106
		BUJES PARA HORQUILLA	DAI-K-6578
95-05		GOMA PARA BARRA ESTABILIZADORA 5/8"	64697
		GOMA PARA BARRA ESTABILIZADORA	6404
		TOPE PARA AMORTIGUADOR FRONTAL IZQUIERDO Y DERECHO	D-0619



TEMPEST

		APLICACIÓN / DESCRIPTION	DAI PARTS #	DAI KIT PARTS #
BASES PARA AMORTIGUADOR / STRUT MOUNTS				
87-91		BASE PARA AMORTIGUADOR TRASERA IZQUIERDA Y DERECHA	1821	1821-KIT
		BASE PARA AMORTIGUADOR FRONTAL IZQUIERDA Y DERECHA	6711	6711-KIT



TORRENT

		APLICACIÓN / DESCRIPTION	DAI PARTS #
SOPORTES / TRANSMISSION & MOTOR MOUNTS			
V6 3.4	06-08	SOPORTE PARA MOTOR TRASERO	7220
		SOPORTE PARA MOTOR FRONTAL	7238
	06-09	SOPORTE PARA MOTOR DERECHO	7473-H

7473-H



		APLICACIÓN / DESCRIPTION	DAI PARTS #	DAI KIT PARTS #
BASES PARA AMORTIGUADOR / STRUT MOUNTS				
05-09		BASE PARA AMORTIGUADOR FRONTAL IZQUIERDA Y DERECHA		7539-KIT



		APLICACIÓN / DESCRIPTION	DAI PARTS #
MISCELÁNEOS / AUTOMOTIVE RUBBER PARTS			
	05-09	BUJE PARA HORQUILLA INFERIOR GRANDE	DAI-1403022
		BUJE PARA HORQUILLA INFERIOR CHICO	DAI-1403019



TRANS AM

 28	APLICACIÓN / DESCRIPTION	DAI PARTS #	DAI KIT PARTS #
BASES PARA AMORTIGUADOR / STRUT MOUNTS			
82-92	BASE PARA AMORTIGUADOR FRONTAL DERECHA	6727	6727-KIT
	BASE PARA AMORTIGUADOR FRONTAL IZQUIERDA	6728	6728-KIT
93-02	BASE PARA AMORTIGUADOR FRONTAL DERECHA	6751	6751-KIT
	BASE PARA AMORTIGUADOR FRONTAL IZQUIERDA	6761	6761-KIT

**BASES PARA AMORTIGUADOR
STRUT MOUNTS**



6727 6727-KIT



6728 6728-KIT



6751

6751-KIT

6761

6761-KIT

 28	APLICACIÓN / DESCRIPTION	DAI PARTS #
MISCELÁNEOS / AUTOMOTIVE RUBBER PARTS		
82-92	TORNILLO ESTABILIZADOR (6", 177.8 mm)	6101
	TORNILLO ESTABILIZADOR (6", 177.8 mm EQUIPO ORIGINAL)	6105
93-02	TORNILLO ESTABILIZADOR (7", 203.2 mm)	6102
	TORNILLO ESTABILIZADOR (7", 203.2 mm EQUIPO ORIGINAL)	6106

**MISCELÁNEOS
AUTOMOTIVE RUBBER PARTS**



6101 6102

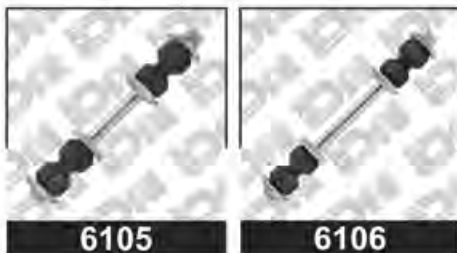

6105

6106



TRANSPORT

 		APLICACIÓN / DESCRIPTION	DAI PARTS #
SOPORTES / TRANSMISSION & MOTOR MOUNTS			
V6 3.4	1996	SOPORTE PARA TRANSMISIÓN TRASERO IZQUIERDO	1837
		SOPORTE PARA TRANSMISIÓN FRONTAL IZQUIERDO	1838
		SOPORTE PARA TRANSMISIÓN FRONTAL IZQUIERDO	1839
	96-06	SOPORTE PARA MOTOR DERECHO	6633-H
		REPUESTO PARA SOPORTE DE TORSIÓN FRONTAL SUPERIOR IZQ. Y DER. (7172)	7172-9
		SOPORTE PARA MOTOR DERECHO	6838-H
97-04	SOPORTE PARA TRANSMISIÓN AUT.	6844	
	SOPORTE PARA MOTOR FRONTAL SUPERIOR IZQUIERDO Y DERECHO	7123	
V6 3.1 V6 3.8	90-95	SOPORTE PARA TRANSMISIÓN FRONTAL IZQUIERDO	1839
SOPORTE PARA MOTOR DERECHO		6633-H	

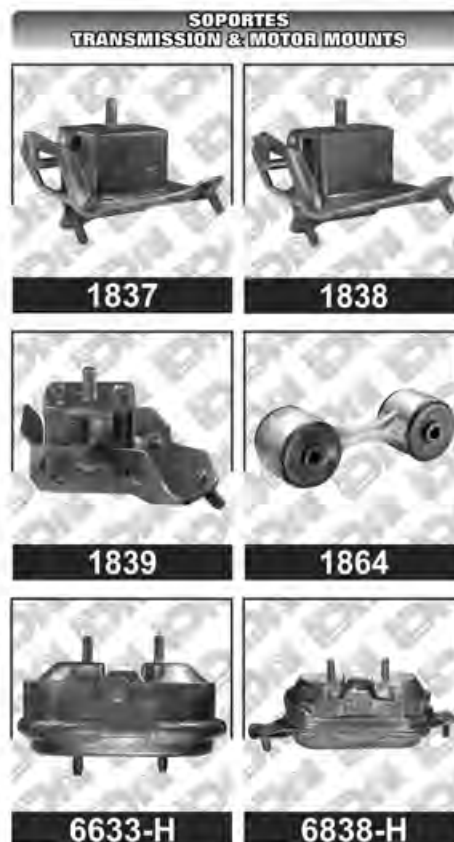

 		APLICACIÓN / DESCRIPTION	DAI PARTS #	DAI KIT PARTS #
BASES PARA AMORTIGUADOR / STRUT MOUNTS				
88-96	BASE PARA AMORTIGUADOR TRASERA IZQUIERDA Y DERECHA	1821	1821-KIT	
	BASE PARA AMORTIGUADOR FRONTAL IZQUIERDA Y DERECHA	6666	6666-KIT	



CONTINUACIÓN... TRANSPORT

28	APLICACIÓN / DESCRIPTION	DAI PARTS #	DAI KIT PARTS #
BASES PARA AMORTIGUADOR / STRUT MOUNTS			
88-96	BASE PARA AMORTIGUADOR FRONTAL IZQUIERDA Y DERECHA	6667	6667-KIT
97-98	BASE PARA AMORTIGUADOR FRONTAL IZQUIERDA Y DERECHA		7222-KIT



28	APLICACIÓN / DESCRIPTION	DAI PARTS #
MISCELÁNEOS / AUTOMOTIVE RUBBER PARTS		
97-98	GOMA PARA BARRA ESTABILIZADORA	64721
	BUJE PARA HORQUILLA GRANDE	DAI-1403005
	BUJE PARA HORQUILLA CHICO	DAI-1403006



VIBE

SOPORTES / TRANSMISSION & MOTOR MOUNTS			
L4 1.8	09-10	REPUESTO PARA SOPORTE DE TRANSMISIÓN (7135 y 7201)	7201-9
		SOPORTE PARA TRANSMISIÓN STD.	7641



CONTINUACIÓN...VIBE

		APLICACIÓN / DESCRIPTION	DAI PARTS #
SOPORTES / TRANSMISSION & MOTOR MOUNTS			
L4 1.8	09-10	SOPORTE PARA MOTOR TRASERO	7674
		SOPORTE PARA MOTOR DERECHO	7695



		APLICACIÓN / DESCRIPTION	DAI PARTS #
MISCELÁNEOS / AUTOMOTIVE RUBBER PARTS			
	03-10	TORNILLO ESTABILIZADOR FRONTAL	DAI-2125008

WAVE

SOPORTES / TRANSMISSION & MOTOR MOUNTS			
L4 1.6	05-08	REPUESTO PARA SOPORTE DE TRANSMISIÓN STD. Y AUT. (7258)	7258-9
		REPUESTO PARA SOPORTE DE MOTOR DERECHO (7259)	7259-9
		REPUESTO PARA SOPORTE DE MOTOR TRASERO (7260)	7260-9



RAMBLER

VARIOS



  28	APLICACIÓN / DESCRIPTION	DAI PARTS #
MISCELÁNEOS / AUTOMOTIVE RUBBER PARTS		
	GOMA PARA BARRA ESTABILIZADORA	6418

MISCELÁNEOS
AUTOMOTIVE RUBBER PARTS



RENAULT

ALLIANCE

  28	APLICACIÓN / DESCRIPTION	DAI PARTS #
CUBRE POLVOS / C.V. BOOTS		
84-86	CUBRE POLVO IZQUIERDO Y DERECHO LADO RUEDA	6321
	CUBRE POLVO IZQUIERDO Y DERECHO LADO CAJA	6389
	CUBRE POLVO IZQUIERDO Y DERECHO LADO CAJA (F. ESPAÑOLA)	6356

CUBRE POLVOS
C.V. BOOTS



CLIO

 		APLICACIÓN / DESCRIPTION	DAI PARTS #
SOPORTES / TRANSMISSION & MOTOR MOUNTS			
L4 1.6	02-10	SOPORTE PARA MOTOR DERECHO	7005
		SOPORTE PARA MOTOR DERECHO	7005-H
		SOPORTE PARA MOTOR TRASERO STD.	7006
		REPUESTO PARA SOPORTE DE MOTOR TRASERO STD. (7006)	7006-9
		SOPORTE PARA MOTOR TRASERO AUT.	7007
		SOPORTE PARA TRANSMISIÓN STD.	7008
		SOPORTE PARA TRANSMISIÓN AUT.	7009
L4 2.0	03-10	SOPORTE PARA MOTOR FRONTAL SUPERIOR	7450



		APLICACIÓN / DESCRIPTION	DAI PARTS #	DAI KIT PARTS #
BASES PARA AMORTIGUADOR / STRUT MOUNTS				
02-10	BASE PARA AMORTIGUADOR FRONTAL IZQUIERDA Y DERECHA		7017	7017-KIT
	BALERO PARA BASE DE AMORTIGUADOR FRONTAL IZQUIERDA Y DERECHA 7017		6147	
07-09	BASE PARA AMORTIGUADOR FRONTAL DERECHA (EUROPA)		7357	
	BASE PARA AMORTIGUADOR FRONTAL IZQUIERDA		7394	7394-KIT



CONTINUACIÓN... CLIO

  28		APLICACIÓN / DESCRIPTION	DAI PARTS #
CUBRE POLVOS / C.V. BOOTS			
02-10		CUBRE POLVO IZQUIERDO Y DERECHO LADO RUEDA	6315
		CUBRE POLVO DERECHO LADO CAJA (CON TRIPOIDE)	6329
		CUBRE POLVO IZQUIERDO LADO CAJA	6331
		CUBRE POLVO IZQUIERDO Y DERECHO DE DIRECCIÓN HID.	6347
		CUBRE POLVO IZQUIERDO DE DIRECCIÓN HID.	6348



MISCELÁNEOS / AUTOMOTIVE RUBBER PARTS			
02-10		GOMA PARA CAJA DE DIRECCIÓN	722
		TOPE PARA AMORTIGUADOR FRONTAL IZQUIERDO Y DERECHO	2010
		TOPE PARA AMORTIGUADOR TRASERO IZQUIERDO Y DERECHO	2013
		GOMA SUJETADORA DE ESCAPE	7144
		GOMA SUJETADORA DE ESCAPE	7338
		TORNILLO ESTABILIZADOR FRONTAL IZQUIERDO Y DERECHO	64420

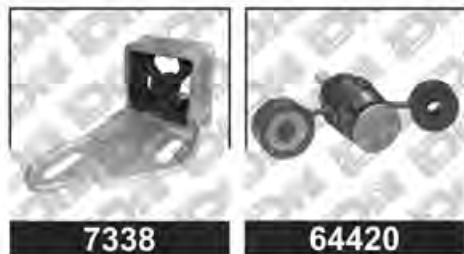

CONTINUACIÓN... CLIO

  28		APLICACIÓN / DESCRIPTION	DAI PARTS #
MISCELÁNEOS / AUTOMOTIVE RUBBER PARTS			
02-10		GOMA PARA BARRA ESTABILIZADORA	64714
		GOMA PARA BARRA ESTABILIZADORA	DAI-1416020
		BUJES PARA EJE TRASERO	DAI-1416021
		BUJES PARA HORQUILLA INFERIOR	DAI-7700-424-399
07-09		BUJE PARA HORQUILLA INFERIOR GRANDE	DAI-1419002
		BUJE PARA HORQUILLA INFERIOR CHICO (EUROPA)	DAI-1416007

DAI-1419002

DAI-7700-424-399

MISCELÁNEOS AUTOMOTIVE RUBBER PARTS	
64714	DAI-1416007
DAI-1416020	DAI-1416021



DUSTER

SOPORTES / TRANSMISSION & MOTOR MOUNTS			
L4 2.0	12-17	SOPORTE PARA TRANSMISIÓN AUT.	7445
		SOPORTE PARA MOTOR DERECHO	7700-H

SOPORTES TRANSMISSION & MOTOR MOUNTS	
7445	7700-H



ENCORE

 		APLICACIÓN / DESCRIPTION	DAI PARTS #
CUBRE POLVOS / C.V. BOOTS			
84-86		CUBRE POLVO IZQUIERDO Y DERECHO LADO RUEDA	6321
		CUBRE POLVO IZQUIERDO Y DERECHO LADO CAJA (FLECHA ESPAÑOLA)	6356
		CUBRE POLVO IZQUIERDO Y DERECHO LADO CAJA	6389



KANGOO

SOPORTES / TRANSMISSION & MOTOR MOUNTS			
L4 1.6	04-12	SOPORTE PARA MOTOR DERECHO	7005
		SOPORTE PARA MOTOR DERECHO	7005-H
		SOPORTE PARA MOTOR TRASERO STD.	7006
		REPUESTO PARA SOPORTE DE MOTOR TRASERO STD. (7006)	7006-9
		SOPORTE PARA MOTOR TRASERO AUT.	7007
		SOPORTE PARA TRANSMISIÓN STD.	7008
		SOPORTE PARA TRANSMISIÓN AUT.	7009
L4 2.0	03-10	SOPORTE PARA MOTOR FRONTAL SUPERIOR	7450



CONTINUACIÓN... KANGOO

28		APLICACIÓN / DESCRIPTION	DAI PARTS #	DAI KIT PARTS #
BASES PARA AMORTIGUADOR / STRUT MOUNTS				
04-12		BALERO PARA BASE DE AMORTIGUADOR FRONTAL IZQUIERDO Y DERECHO 7017	6147	
		BASE PARA AMORTIGUADOR FRONTAL IZQUIERDA Y DERECHA	7017	7017-KIT

7017-KIT

28		APLICACIÓN / DESCRIPTION	DAI PARTS #
MISCELÁNEOS / AUTOMOTIVE RUBBER PARTS			
02-15		BUJES PARA HORQUILLA INFERIOR	DAI-7700-424-399
		GOMA PARA BARRA ESTABILIZADORA	6421
04-12		GOMA SUJETADORA DE ESCAPE	7338
		TORNILLO ESTABILIZADOR FRONTAL IZQUIERDO Y DERECHO	64420
		GOMA PARA BARRA ESTABILIZADORA	64714
		GOMA PARA BARRA ESTABILIZADORA	DAI-1416020
04-17		BUJES PARA EJE TRASERO	DAI-1416021

DAI-1416020

DAI-1416021

DAI-7700-424-399



KOLEOS

		APLICACIÓN / DESCRIPTION	DAI PARTS #
--	--	--------------------------	-------------

SOPORTES / TRANSMISSION & MOTOR MOUNTS

L4 2.5	08-16	SOPORTE PARA MOTOR TRASERO	7405
		SOPORTE PARA MOTOR DERECHO SUPERIOR (TORSIÓN)	7409
		SOPORTE PARA MOTOR DERECHO	7693-H

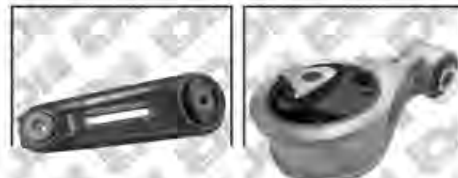
**SOPORTES
TRANSMISSION & MOTOR MOUNTS**



7405

7409



7693-H

	APLICACIÓN / DESCRIPTION	DAI PARTS #	DAI KIT PARTS #
--	--------------------------	-------------	-----------------

BASES PARA AMORTIGUADOR / STRUT MOUNTS

08-16	BASE PARA AMORTIGUADOR FRONTAL IZQUIERDA		7410-KIT
	BASE PARA AMORTIGUADOR FRONTAL DERECHA		7411-KIT
	BALERO PARA BASE DE AMORTIGUADOR FRONTAL IZQUIERDA Y DERECHA 7357, 7394, 7410-KIT Y 7411-KIT	6149	

**BASES PARA AMORTIGUADOR
STRUT MOUNTS**



6149

7410-KIT



7411-KIT

		APLICACIÓN / DESCRIPTION	DAI PARTS #
--	--	--------------------------	-------------

CUBRE POLVOS / C.V. BOOTS

	08-16	CUBRE POLVO IZQUIERDO Y DERECHO LADO RUEDA	63173
--	-------	--	-------

**CUBRE POLVOS
C.V. BOOTS**



63173



755

IMPORTANTE: Identifica nuestro producto con el grabado del logo No aceptes imitaciones.



CONTINUACIÓN... KOLEOS

		APLICACIÓN / DESCRIPTION	DAI PARTS #
MISCELÁNEOS / AUTOMOTIVE RUBBER PARTS			
	08-16	BUJES PARA HORQUILLA (POLIURETANO KIT)	9806



LAGUNA

SOPORTES / TRANSMISSION & MOTOR MOUNTS			
V6 3.0	03-06	SOPORTE PARA MOTOR TRASERO	7464



	APLICACIÓN / DESCRIPTION	DAI PARTS #	DAI KIT PARTS #
BASES PARA AMORTIGUADOR / STRUT MOUNTS			
03-06	BASE PARA AMORTIGUADOR FRONTAL IZQUIERDA Y DERECHA		7505-KIT



		APLICACIÓN / DESCRIPTION	DAI PARTS #
MISCELÁNEOS / AUTOMOTIVE RUBBER PARTS			
	03-06	TORNILLO ESTABILIZADOR FRONTAL	DAI-2119001



MEGANE I

  28		APLICACIÓN / DESCRIPTION	DAI PARTS #
SOPORTES / TRANSMISSION & MOTOR MOUNTS			
L4 2.0	01-04	SOPORTE PARA MOTOR TRASERO	7034
		SOPORTE PARA MOTOR DERECHO	7036-H
		SOPORTE PARA TRANSMISIÓN AUT.	7037
		SOPORTE PARA MOTOR TRASERO	7434



MISCELÁNEOS / AUTOMOTIVE RUBBER PARTS			
	01-04	GOMA PARA CAJA DE DIRECCIÓN	722
		GOMA PARA BARRA ESTABILIZADORA	6421



MEGANE II

SOPORTES / TRANSMISSION & MOTOR MOUNTS			
L4 2.0	05-10	SOPORTE PARA MOTOR DERECHO	7162-H
		SOPORTE PARA MOTOR TRASERO	7163
		SOPORTE PARA MOTOR DERECHO SUPERIOR	7331



CONTINUACIÓN... MEGANE II

28	APLICACIÓN / DESCRIPTION	DAI PARTS #	DAI KIT PARTS #
BASES PARA AMORTIGUADOR / STRUT MOUNTS			
05-10	BASE PARA AMORTIGUADOR FRONTAL IZQUIERDO Y DERECHO		7507-KIT

**BASES PARA AMORTIGUADOR
STRUT MOUNTS**

7507-KIT

28	APLICACIÓN / DESCRIPTION	DAI PARTS #
MISCELÁNEOS / AUTOMOTIVE RUBBER PARTS		
05-10	GOMA PARA CAJA DE DIRECCIÓN	722
	BUJE PARA HORQUILLA INFERIOR GRANDE	DAI-1419002

**MISCELÁNEOS
AUTOMOTIVE RUBBER PARTS**

722

DAI-1419002
R5

SOPORTES / TRANSMISSION & MOTOR MOUNTS			
L4 1.3	74-84	SOPORTE PARA TRANSMISIÓN STD.	1790
		SOPORTE PARA MOTOR DERECHO STD.	6627

**SOPORTES
TRANSMISSION & MOTOR MOUNTS**

1790

6627



CUBRE POLVOS / C.V. BOOTS			
	74-84	CUBRE POLVO IZQUIERDO Y DERECHO LADO RUEDA	6321
		CUBRE POLVO IZQUIERDO Y DERECHO LADO CAJA (FLECHA IMPORTADA)	6322

**CUBRE POLVOS
C.V. BOOTS**

6321

6322

CONTINUACIÓN... R5

  28		APLICACIÓN / DESCRIPTION	DAI PARTS #
CUBRE POLVOS / C.V. BOOTS			
74-84		CUBRE POLVO IZQUIERDO Y DERECHO LADO CAJA	6325
		CUBRE POLVO IZQUIERDO Y DERECHO DE DIRECCIÓN HID.	6354
		CUBRE POLVO IZQUIERDO Y DERECHO LADO CAJA	6389



R8

SOportes / TRANSMISSION & MOTOR MOUNTS			
L4 1.3	61-74	SOPORTE PARA MOTOR IZQUIERDO Y DERECHO	1732





R9

CUBRE POLVOS / C.V. BOOTS			
84-86		CUBRE POLVO IZQUIERDO Y DERECHO LADO RUEDA	6321
		CUBRE POLVO IZQUIERDO Y DERECHO LADO CAJA	6389



CONTINUACIÓN... R9

	 28	APLICACIÓN / DESCRIPTION	DAI PARTS #
CUBRE POLVOS / C.V. BOOTS			
84-86		CUBRE POLVO IZQUIERDO Y DERECHO LADO CAJA (FLECHA ESPAÑOLA)	6356

R10

SOPORTES / TRANSMISSION & MOTOR MOUNTS			
L4 1.3	61-74	SOPORTE PARA MOTOR IZQUIERDO Y DERECHO	1732

R12



SOPORTES / TRANSMISSION & MOTOR MOUNTS			
L4 1.6	73-84	SOPORTE PARA MOTOR IZQUIERDO Y DERECHO	1767
		SOPORTE PARA TRANSMISIÓN	1768



CUBRE POLVOS / C.V. BOOTS			
	73-84	CUBRE POLVO IZQUIERDO Y DERECHO LADO RUEDA (FLECHA IMPORTADA)	6321
		CUBRE POLVO IZQUIERDO Y DERECHO LADO RUEDA (FLECHA IMPORTADA)	6323



CONTINUACIÓN... R12

 		APLICACIÓN / DESCRIPTION	DAI PARTS #
CUBRE POLVOS / C.V. BOOTS			
73-84	CUBRE POLVO IZQUIERDO Y DERECHO LADO CAJA		6324



MISCELÁNEOS / AUTOMOTIVE RUBBER PARTS			
73-84	GOMA PARA BARRA ESTABILIZADORA		6066



R18

CUBRE POLVOS / C.V. BOOTS			
74-85	CUBRE POLVO IZQUIERDO Y DERECHO LADO RUEDA		6304
	CUBRE POLVO IZQUIERDO Y DERECHO LADO RUEDA		6321
	CUBRE POLVO IZQUIERDO Y DERECHO LADO CAJA		6325



CONTINUACIÓN... R18

	 28	APLICACIÓN / DESCRIPTION	DAI PARTS #
MISCELÁNEOS / AUTOMOTIVE RUBBER PARTS			
	74-85	BUJE PARA BARRA DE TORSIÓN	6068
		GOMA PARA BARRA ESTABILIZADORA	6067

SAFRANE

MISCELÁNEOS / AUTOMOTIVE RUBBER PARTS			
	09-10	BUJE PARA HORQUILLA INFERIOR GRANDE (SIN SOPORTE)	DAI-1416059

SANDERO

SOPORTES / TRANSMISSION & MOTOR MOUNTS			
L4 1.6	10-14	SOPORTE PARA MOTOR DERECHO (8 VALVULAS)	7444
		SOPORTE PARA MOTOR DERECHO (16 VALVULAS)	7783-H
	10-14	SOPORTE PARA MOTOR TRASERO	7196
		SOPORTE PARA TRANSMISIÓN	7445



CONTINUACIÓN... SANDERO

28		APLICACIÓN / DESCRIPTION	DAI PARTS #	DAI KIT PARTS #
BASES PARA AMORTIGUADOR / STRUT MOUNTS				
10-14		BASE PARA AMORTIGUADOR FRONTAL IZQUIERDA Y DERECHA		7443-KIT
		BALERO PARA BASE DE AMORTIGUADOR (7443-KIT)	6147	



28		APLICACIÓN / DESCRIPTION	DAI PARTS #
CUBRE POLVOS / C.V. BOOTS			
10-14		CUBRE POLVO IZQUIERDO Y DERECHO LADO CAJA (CON TRIPOIDE)	63169



SCALA

SOPORTES / TRANSMISSION & MOTOR MOUNTS			
L4 1.8	10-12	SOPORTE PARA MOTOR TRASERO	7010
		SOPORTE PARA MOTOR DERECHO	7038
		SOPORTE PARA TRANSMISIÓN AUT.	7040
		SOPORTE PARA MOTOR FRONTAL	7067
		SOPORTE PARA TRANSMISIÓN STD.	7069
		REPUESTO PARA SOPORTE MOTOR TRASERO (7010)	1944





CONTINUACIÓN... SCALA

 		APLICACIÓN / DESCRIPTION	DAI PARTS #
SOPORTES / TRANSMISSION & MOTOR MOUNTS			
L4 1.8	10-12	REPUESTO PARA SOPORTE DE TRANSMISIÓN STD. (7069)	7069-9
		REPUESTO PARA SOPORTES DE MOTOR Y TRANSMISIÓN (7032,7040 Y 7265)	7217-9



		APLICACIÓN / DESCRIPTION	DAI PARTS #	DAI KIT PARTS #
BASES PARA AMORTIGUADOR / STRUT MOUNTS				
10-12		BASE PARA AMORTIGUADOR FRONTAL IZQUIERDA Y DERECHA	7026	7026-KIT
		BASE PARA AMORTIGUADOR TRASERA IZQUIERDA Y DERECHA		7318-KIT



 		APLICACIÓN / DESCRIPTION	DAI PARTS #
CUBRE POLVOS / C.V. BOOTS			
	10-12	CUBRE POLVO IZQUIERDO Y DERECHO LADO CAJA (CON TRIPOIDE)	6310
		CUBRE POLVO IZQUIERDO Y DERECHO LADO CAJA (CON TRIPOIDE)	6328



CONTINUACIÓN... SCALA

 		APLICACIÓN / DESCRIPTION	DAI PARTS #
MISCELÁNEOS / AUTOMOTIVE RUBBER PARTS			
10-12		GOMA PARA BARRA ESTABILIZADORA	64715
		BUJE PARA EJE TRASERO	64810
		BUJE PARA HORQUILLA CHICO	DAI-1416003
		BUJE PARA HORQUILLA GRANDE	DAI-1416004
		GOMA PARA BARRA ESTABILIZADORA	DAI-1416019





SCENIC I

		SOPORTES / TRANSMISSION & MOTOR MOUNTS	
L4 2.0	01-04	SOPORTE PARA MOTOR TRASERO	7034
		SOPORTE PARA MOTOR DERECHO	7036-H
		SOPORTE PARA TRANSMISIÓN AUT.	7037
		SOPORTE PARA MOTOR TRASERO	7434



CONTINUACIÓN... SCENIC I

 		APLICACIÓN / DESCRIPTION	DAI PARTS #
CUBRE POLVOS / C.V. BOOTS			
01-04		CUBRE POLVO IZQUIERDO Y DERECHO LADO RUEDA	6316
		CUBRE POLVO IZQUIERDO LADO CAJA	6331



MISCELÁNEOS / AUTOMOTIVE RUBBER PARTS		
01-04	GOMA PARA BARRA ESTABILIZADORA	6421

SCENIC II

SOPORTES / TRANSMISSION & MOTOR MOUNTS			
L4 2.0	05-09	SOPORTE PARA MOTOR DERECHO	7162-H
		SOPORTE PARA MOTOR TRASERO	7163
		SOPORTE PARA MOTOR DERECHO SUPERIOR	7331



		APLICACIÓN / DESCRIPTION	DAI PARTS #	DAI KIT PARTS #
BASES PARA AMORTIGUADOR / STRUT MOUNTS				
05-09		BASE PARA AMORTIGUADOR FRONTAL IZQUIERDA Y DERECHA		7507-KIT



CONTINUACIÓN... SCENIC II

 	APLICACIÓN / DESCRIPTION	DAI PARTS #
MISCELÁNEOS / AUTOMOTIVE RUBBER PARTS		
05-09	BUJE PARA HORQUILLA INFERIOR GRANDE	DAI-1419002



STEPWAY



SOPORTES / TRANSMISSION & MOTOR MOUNTS			
L4 1.6	10-16	SOPORTE PARA MOTOR DERECHO (8 VALVULAS)	7444
		SOPORTE PARA MOTOR DERECHO (16 VALVULAS)	7783-H
		SOPORTE PARA TRANSMISIÓN	7445
		SOPORTE PARA MOTOR TRASERO	7407
		SOPORTE PARA MOTOR TRASERO	7196



	APLICACIÓN / DESCRIPTION	DAI PARTS #	DAI KIT PARTS #
BASES PARA AMORTIGUADOR / STRUT MOUNTS			
10-16	BASE PARA AMORTIGUADOR FRONTAL IZQUIERDA Y DERECHA		7443-KIT
	BALERO PARA BASE DE AMORTIGUADOR (7443-KIT)	6147	



CONTINUACIÓN... STEPWAY

	 28	APLICACIÓN / DESCRIPTION	DAI PARTS #
CUBRE POLVOS / C.V. BOOTS			
	10-16	CUBRE POLVO IZQUIERDO Y DERECHO LADO CAJA (CON TRIPOIDE)	63169

TL

SOPORTES / TRANSMISSION & MOTOR MOUNTS			
L4 1.3	73-84	SOPORTE PARA MOTOR IZQUIERDO Y DERECHO	1767
		SOPORTE PARA TRANSMISIÓN	1768

TRAFIC

SOPORTES / TRANSMISSION & MOTOR MOUNTS			
L4 1.9	07-14	SOPORTE PARA MOTOR DERECHO	7347-H



 28	APLICACIÓN / DESCRIPTION	DAI PARTS #	DAI KIT PARTS #
BASES PARA AMORTIGUADOR / STRUT MOUNTS			
07-14	BASE PARA AMORTIGUADOR FRONTAL IZQUIERDA Y DERECHA		7506-KIT



CONTINUACIÓN... TRAFIC

 		APLICACIÓN / DESCRIPTION	DAI PARTS #
MISCELÁNEOS / AUTOMOTIVE RUBBER PARTS			
	07-14	TORNILLO ESTABILIZADOR FRONTAL	DAI-2119001



TS

SOPORTES / TRANSMISSION & MOTOR MOUNTS			
L4 1.6	73-84	SOPORTE PARA MOTOR IZQUIERDO Y DERECHO	1767
		SOPORTE PARA TRANSMISIÓN	1768



VARIOS

MISCELÁNEOS / AUTOMOTIVE RUBBER PARTS			
		GALLETAS PARA DIRECCIÓN STD. Y HID. (NO REQUIERE PERNOS COMPLETO 609)	623
		GOMA SUJETADORA DE ESCAPE	6545



SAAB

9-3

  28		APLICACIÓN / DESCRIPTION	DAI PARTS #
SOPORTES / TRANSMISSION & MOTOR MOUNTS			
L4 1.9	05-12	SOPORTE PARA MOTOR TRASERO	7313
		SOPORTE PARA MOTOR FRONTAL	7478



 28		APLICACIÓN / DESCRIPTION	DAI PARTS #	DAI KIT PARTS #
BASES PARA AMORTIGUADOR / STRUT MOUNTS				
03-11		BASE PARA AMORTIGUADOR FRONTAL IZQUIERDO Y DERECHO (9-3X)	7317	



  28		APLICACIÓN / DESCRIPTION	DAI PARTS #
MISCELÁNEOS / AUTOMOTIVE RUBBER PARTS			
	03-07	BUJE PARA HORQUILLA INFERIOR CHICO	DAI-352364



9-7X

SOPORTES / TRANSMISSION & MOTOR MOUNTS			
L6 4.2	05-07	SOPORTE PARA MOTOR IZQUIERDO Y DERECHO	7244-H
		SOPORTE PARA TRANSMISIÓN AUT.	7311



SATURN
AURA

 28		APLICACIÓN / DESCRIPTION	DAI PARTS #
SOPORTES / TRANSMISSION & MOTOR MOUNTS			
L4 2.4	07-08	SOPORTE PARA TRANSMISIÓN	7655
V6 3.5	2007	SOPORTE PARA TRANSMISIÓN	7655
	07-09	SOPORTE PARA TRANSMISIÓN	7562-H
		SOPORTE PARA MOTOR DERECHO	7563-H
		SOPORTE PARA MOTOR FRONTAL	7400
V6 3.6	07-09	SOPORTE PARA MOTOR DERECHO	7563-H

**SOPORTES
TRANSMISSION & MOTOR MOUNTS**

7400

7562-H

7563-H

7655
ION
SOPORTES / TRANSMISSION & MOTOR MOUNTS

L4 2.0	04-07	SOPORTE PARA MOTOR DERECHO STD.	7471-H
		SOPORTE PARA MOTOR DERECHO AUT.	7472-H

**SOPORTES
TRANSMISSION & MOTOR MOUNTS**

7471-H

7472-H
MISCELÁNEOS / AUTOMOTIVE RUBBER PARTS

	03-07	TORNILLO ESTABILIZADOR FRONTAL	DAI-2103001
--	-------	--------------------------------	-------------

**MISCELÁNEOS
AUTOMOTIVE RUBBER PARTS**

DAI-2103001

ION 1

 		APLICACIÓN / DESCRIPTION	DAI PARTS #
SOPORTES / TRANSMISSION & MOTOR MOUNTS			
L4 2.2	03-05	SOPORTE PARA MOTOR TRASERO	7233
		SOPORTE PARA MOTOR DERECHO STD.	7471-H
		SOPORTE PARA MOTOR DERECHO AUT.	7472-H
		SOPORTE PARA MOTOR TRASERO AUT.	7520
	2005	SOPORTE PARA MOTOR FRONTAL	7234



ION 2

SOPORTES / TRANSMISSION & MOTOR MOUNTS			
L4 2.2	03-07	SOPORTE PARA MOTOR TRASERO	7233
		SOPORTE PARA MOTOR DERECHO STD.	7471-H
		SOPORTE PARA MOTOR DERECHO AUT.	7472-H
		2005	SOPORTE PARA MOTOR FRONTAL



ION 3



		APLICACIÓN / DESCRIPTION	DAI PARTS #
SOPORTES / TRANSMISSION & MOTOR MOUNTS			
L4 2.2	03-07	SOPORTE PARA MOTOR TRASERO	7233
		SOPORTE PARA MOTOR DERECHO STD.	7471-H
		SOPORTE PARA MOTOR DERECHO AUT.	7472-H
		SOPORTE PARA MOTOR TRASERO AUT.	7520
2005		SOPORTE PARA MOTOR FRONTAL	7234

OUTLOOK

SOPORTES / TRANSMISSION & MOTOR MOUNTS			
V6 3.6	09-10	SOPORTE PARA MOTOR TRASERO DERECHO	7559-H
		SOPORTE PARA MOTOR TRASERO TORQUE STRUT	7587
		SOPORTE PARA MOTOR FRONTAL DERECHO	7735



RELAY

  28		APLICACIÓN / DESCRIPTION	DAI PARTS #
SOPORTES / TRANSMISSION & MOTOR MOUNTS			
V6 3.5	05-06	SOPORTE PARA MOTOR FRONTAL SUPERIOR IZQUIERDO Y DERECHO	7123
V6 3.9	06-07		



MISCELÁNEOS / AUTOMOTIVE RUBBER PARTS			
	05-07	TORNILLO ESTABILIZADOR	DAI-15851956



VUE

SOPORTES / TRANSMISSION & MOTOR MOUNTS			
L4 2.2	02-07	SOPORTE PARA MOTOR DERECHO STD.	7471-H
		SOPORTE PARA MOTOR DERECHO AUT.	7472-H
L4 2.4	07-09	SOPORTE PARA MOTOR DERECHO STD.	7471-H
		SOPORTE PARA MOTOR DERECHO AUT.	7472-H
V6 3.0	02-03	SOPORTE PARA MOTOR DERECHO	7473-H
V6 3.6	08-10	SOPORTE PARA MOTOR DERECHO	7541-H



CONTINUACIÓN... VUE

 28	APLICACIÓN / DESCRIPTION	DAI PARTS #	DAI KIT PARTS #
BASES PARA AMORTIGUADOR / STRUT MOUNTS			
02-06	BASE PARA AMORTIGUADOR FRONTAL IZQUIERDA Y DERECHA		7539-KIT



 28	APLICACIÓN / DESCRIPTION	DAI PARTS #
MISCELÁNEOS / AUTOMOTIVE RUBBER PARTS		
02-09	BUJE PARA HORQUILLA INFERIOR CHICO	DAI-1403019
	BUJE PARA HORQUILLA INFERIOR GRANDE	DAI-1403022



SEAT

ALHAMBRA

  28		APLICACIÓN / DESCRIPTION	DAI PARTS #
SOPORTES / TRANSMISSION & MOTOR MOUNTS			
V6 2.8	02-08	REPUESTO PARA SOPORTE DE MOTOR TRASERO	7549-9
		SOPORTE PARA MOTOR DERECHO	7576





CUBRE POLVOS / C.V. BOOTS			
	02-08	CUBRE POLVO IZQUIERDO Y DERECHO LADO RUEDA	63184
		CUBRE POLVO IZQUIERDO Y DERECHO LADO CAJA (CON TRIPOIDE)	63185
		CUBRE POLVO IZQUIERDO Y DERECHO DE DIRECCIÓN	63186



MISCELÁNEOS / AUTOMOTIVE RUBBER PARTS		
02-05	TORNILLO ESTABILIZADOR FRONTAL	DAI-2126003



ALTEA

		APLICACIÓN / DESCRIPTION	DAI PARTS #
SOPORTES / TRANSMISSION & MOTOR MOUNTS			
L4 1.4	06-15	SOPORTE PARA TRANSMISIÓN STD. Y AUT.	7212
		SOPORTE PARA MOTOR TRASERO TORQUE STRUT	7254
L4 1.6	06-15	SOPORTE PARA TRANSMISIÓN STD. Y AUT.	7212
		SOPORTE PARA MOTOR TRASERO TORQUE STRUT	7254
L4 1.8	06-15	SOPORTE PARA TRANSMISIÓN	7211
L4 2.0	06-15	SOPORTE PARA TRANSMISIÓN	7211
		SOPORTE PARA TRANSMISIÓN STD. Y AUT.	7212
		SOPORTE PARA MOTOR TRASERO TORQUE STRUT	7254

**SOPORTES
TRANSMISSION & MOTOR MOUNTS**

7211

7212

7254

	APLICACIÓN / DESCRIPTION	DAI PARTS #	DAI KIT PARTS #
BASES PARA AMORTIGUADOR / STRUT MOUNTS			
06-12	BALERO PARA BASE DE AMORTIGUADOR FRONTAL IZQUIERDO Y DERECHO (7214)	6145	

**BASES PARA AMORTIGUADOR
STRUT MOUNTS**

6145



MISCELÁNEOS / AUTOMOTIVE RUBBER PARTS			
	06-12	BUJE PARA HORQUILLA INFERIOR CHICO	DAI-1426011
		TORNILLO ESTABILIZADOR DELANTERO	DAI-2126010

**MISCELÁNEOS
AUTOMOTIVE RUBBER PARTS**

DAI-1426011

DAI-2126010

CORDOBA

  28		APLICACIÓN / DESCRIPTION	DAI PARTS #
SOPORTES / TRANSMISSION & MOTOR MOUNTS			
L4 1.6 L4 2.0	00-02	SOPORTE PARA MOTOR FRONTAL	6661
		SOPORTE PARA MOTOR TRASERO	6662
		SOPORTE PARA TRANSMISIÓN STD.	6663
		SOPORTE PARA TRANSMISIÓN STD. (SOLIDO)	6663-S
		SOPORTE PARA TRANSMISIÓN AUT.	6693
		SOPORTE O BASE PARA CARBURADOR	6823
		SOPORTE PARA TRANSMISIÓN STD. Y AUT.	6829
03-08		SOPORTE PARA MOTOR TRASERO (CON BASE)	6842
		SOPORTE PARA MOTOR DERECHO	7057-H
		SOPORTE PARA MOTOR TRASERO	7058
		SOPORTE PARA TRANSMISIÓN	7060

**SOPORTES
TRANSMISSION & MOTOR MOUNTS**



6661



6662



6663



6663-S



6693



6823



6829



6842



7057-H



7058



7060

 28		APLICACIÓN / DESCRIPTION	DAI PARTS #	DAI KIT PARTS #
BASES PARA AMORTIGUADOR / STRUT MOUNTS				
03-08		BASE PARA AMORTIGUADOR TRASERA IZQUIERDA Y DERECHA	6906	

**BASES PARA AMORTIGUADOR
STRUT MOUNTS**



6906



CONTINUACIÓN... CORDOBA

28		APLICACIÓN / DESCRIPTION	DAI PARTS #	DAI KIT PARTS #
BASES PARA AMORTIGUADOR / STRUT MOUNTS				
03-08		BASE PARA AMORTIGUADOR FRONTAL IZQUIERDA Y DERECHA	7214	7214-KIT
03-09		BALERO PARA BASE DE AMORTIGUADOR FRONTAL IZQUIERDA Y DERECHA (7214)	6145	

7214-KIT

28		APLICACIÓN / DESCRIPTION	DAI PARTS #
CUBRE POLVOS / C.V. BOOTS			
	00-08	CUBRE POLVO IZQUIERDO Y DERECHO LADO RUEDA	6384
		CUBRE POLVO IZQUIERDO Y DERECHO LADO CAJA	6382
		CUBRE POLVO IZQUIERDO Y DERECHO LADO CAJA	6302
		CUBRE POLVO IZQUIERDO Y DERECHO DE DIRECCIÓN	6374



MISCELÁNEOS / AUTOMOTIVE RUBBER PARTS		
01-02	TORNILLO ESTABILIZADOR FRONTAL IZQUIERDO Y DERECHO	DAI-2126005



CONTINUACIÓN... CORDOBA

		28	APLICACIÓN / DESCRIPTION	DAI PARTS #
MISCELÁNEOS / AUTOMOTIVE RUBBER PARTS				
	01-02		BUJE PARA HORQUILLA CHICO	DAI-191-407-182
	01-09		BUJE PARA EJE TRASERO	DAI-1J0-501-541
			BUJE PARA EJE TRASERO IZQUIERDO Y DERECHO	DAI-1426037
03-08			TOPE PARA AMORTIGUADOR TRASERO IZQUIERDO Y DERECHO	D-050
			TOPE PARA AMORTIGUADOR FRONTAL IZQUIERDO Y DERECHO	D-074
			BUJE INFERIOR GRANDE	64812
			BUJE PARA HORQUILLA INFERIOR CHICO	DAI-1426003
	03-09		TORNILLO ESTABILIZADOR FRONTAL	DAI-2126004



IBIZA

		SOPORTES / TRANSMISSION & MOTOR MOUNTS	
L4 1.6	01-02	SOPORTE PARA MOTOR FRONTAL STD.	6658
		SOPORTE PARA MOTOR DERECHO	6659
		SOPORTE PARA MOTOR FRONTAL	6661
		SOPORTE PARA MOTOR TRASERO	6662





CONTINUACIÓN... IBIZA

 		APLICACIÓN / DESCRIPTION	DAI PARTS #
SOPORTES / TRANSMISSION & MOTOR MOUNTS			
L4 1.6	01-02	SOPORTE PARA TRANSMISIÓN STD.	6663
		SOPORTE PARA TRANSMISIÓN STD. (SOLIDO)	6663-S
		SOPORTE PARA TRANSMISIÓN STD.	6660
		SOPORTE PARA TRANSMISIÓN AUT.	6693
		SOPORTE PARA MOTOR TRASERO (CON BASE)	6842
		SOPORTE PARA TRANSMISIÓN STD. Y AUT.	6829
L4 1.6 L4 1.8	03-09	SOPORTE PARA MOTOR DERECHO	7057-H
SOPORTE PARA MOTOR TRASERO		7058	
SOPORTE PARA TRANSMISIÓN		7060	
L4 2.0	01-02	SOPORTE O BASE PARA CARBURADOR	6823
	03-13	SOPORTE PARA MOTOR DERECHO	7057-H
		SOPORTE PARA MOTOR TRASERO	7058
		SOPORTE PARA TRANSMISIÓN	7060

			
6842	7057-H	7058	7060

SOPORTES TRANSMISSION & MOTOR MOUNTS	
	
6660	6663
	
6663-S	6693
	
6823	6829

 		APLICACIÓN / DESCRIPTION	DAI PARTS #	DAI KIT PARTS #
BASES PARA AMORTIGUADOR / STRUT MOUNTS				
09-14		BASE PARA AMORTIGUADOR FRONTAL IZQUIERDA Y DERECHA	1815	1815-KIT

BASES PARA AMORTIGUADOR STRUT MOUNTS	
	
1815	1815-KIT



CONTINUACIÓN... IBIZA

28	APLICACIÓN / DESCRIPTION	DAI PARTS #	DAI KIT PARTS #
BASES PARA AMORTIGUADOR / STRUT MOUNTS			
03-08	BASE PARA AMORTIGUADOR TRASERA IZQUIERDA Y DERECHA	6906	
	BALERO PARA BASE DE AMORTIGUADOR FRONTAL IZQUIERDA Y DERECHA (7214)	6145	
	BASE PARA AMORTIGUADOR FRONTAL IZQUIERDA Y DERECHA	7214	7214-KIT
09-14	BASE PARA AMORTIGUADOR FRONTAL IZQUIERDA Y DERECHA	1816	
	BASE PARA AMORTIGUADOR FRONTAL IZQUIERDA Y DERECHA	6759	6759-KIT
09-15	BALERO PARA BASE DE AMORTIGUADOR (1815)	6119	

BASES PARA AMORTIGUADOR STRUT MOUNTS



1816

6119



6145

6759



6759-KIT

6906

7214

7214-KIT

28	APLICACIÓN / DESCRIPTION	DAI PARTS #
CUBRE POLVOS / C.V. BOOTS		
01-08	CUBRE POLVO IZQUIERDO Y DERECHO LADO CAJA	6302
	CUBRE POLVO IZQUIERDO Y DERECHO LADO RUEDA	6305
	CUBRE POLVO IZQUIERDO Y DERECHO DE DIRECCIÓN	6374
	CUBRE POLVO IZQUIERDO Y DERECHO LADO CAJA	6382

CUBRE POLVOS C.V. BOOTS



6302

6305



6374

6382



CONTINUACIÓN... IBIZA

		28	APLICACIÓN / DESCRIPTION	DAI PARTS #	MISCELÁNEOS / AUTOMOTIVE RUBBER PARTS	
01-02	TORNILLO ESTABILIZADOR FRONTAL IZQUIERDO Y DERECHO		DAI-2126005			
	BUJE PARA HORQUILLA CHICO		DAI-191-407-182			
01-08	TOPE PARA AMORTIGUADOR TRASERO IZQUIERDO Y DERECHO		D-050			
	TOPE PARA AMORTIGUADOR FRONTAL IZQUIERDO Y DERECHO		D-074			
01-17	BUJE PARA EJE TRASERO IZQUIERDO Y DERECHO		DAI-1426037			
03-08	GOMA PARA BARRA ESTABILIZADORA 5/8"		6574			
	GOMA PARA BARRA ESTABILIZADORA 3/4"		64709			
	BUJE INFERIOR GRANDE		64812			
	BUJE PARA HORQUILLA INFERIOR CHICO		DAI-1426003			
03-15	TORNILLO ESTABILIZADOR FRONTAL		DAI-2126004			
09-15	BUJES PARA HORQUILLA INFERIOR CHICO Y GRANDE (POLIURETANO KIT)		9800			
	BUJES PARA HORQUILLA INFERIOR (POLIURETANO KIT CON CASQUILLO)		9809			
	BUJE PARA HORQUILLA INFERIOR GRANDE (CON CEJA BUJE INTERNO CHICO)		64650			



CONTINUACIÓN... IBIZA

 		APLICACIÓN / DESCRIPTION	DAI PARTS #
MISCELÁNEOS / AUTOMOTIVE RUBBER PARTS			
09-15		BUJE PARA HORQUILLA INFERIOR GRANDE (CON CEJA BUJE INTERNO GRANDE)	64651
		BUJE PARA HORQUILLA INFERIOR GRANDE (SIN CEJA BUJE INTERO GRANDE)	64760
		BUJE PARA EJE TRASERO IZQUIERDO Y DERECHO	DAI-1J0-501-541



DAI-1J0-501-541

LEON

SOPORTES / TRANSMISSION & MOTOR MOUNTS			
L4 1.8 L4 2.0	00-06	SOPORTE PARA MOTOR FRONTAL STD.	6658
		SOPORTE PARA MOTOR DERECHO	6659
		SOPORTE PARA TRANSMISIÓN STD.	6660
		SOPORTE PARA MOTOR DERECHO	6976-H
		SOPORTE PARA MOTOR TRASERO	6978
		SOPORTE PARA TRANSMISIÓN	6977
L4 2.0	06-14	SOPORTE PARA TRANSMISIÓN STD. Y AUT.	7212
		SOPORTE PARA MOTOR TRASERO TORQUE STRUT	7254

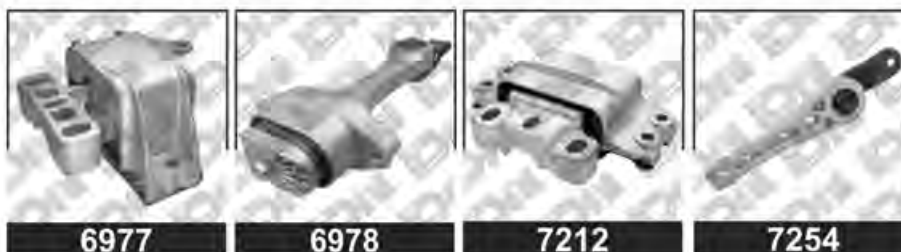

CONTINUACIÓN... LEON

 		APLICACIÓN / DESCRIPTION	DAI PARTS #
SOPORTES / TRANSMISSION & MOTOR MOUNTS			
L4 2.0	07-12	SOPORTE PARA MOTOR TRASERO SUPERIOR (CON CUERDA)	7194
		SOPORTE PARA MOTOR TRASERO INFERIOR (SIN CUERDA)	7195
		SOPORTE PARA TRANSMISIÓN AUT.	7211
L4 1.9 TDI 2.0 TDI	06-14	SOPORTE PARA TRANSMISIÓN STD. Y AUT.	7212
		SOPORTE PARA MOTOR TRASERO TORQUE STRUT	7254

7254

		APLICACIÓN / DESCRIPTION	DAI PARTS #	DAI KIT PARTS #
BASES PARA AMORTIGUADOR / STRUT MOUNTS				
01-05	BASE PARA AMORTIGUADOR TRASERA IZQUIERDA Y DERECHA	6906		
	BASE PARA AMORTIGUADOR FRONTAL IZQUIERDA Y DERECHA	1815	1815-KIT	
	BASE PARA AMORTIGUADOR FRONTAL IZQUIERDA Y DERECHA	1816		
	BASE PARA AMORTIGUADOR FRONTAL IZQUIERDA Y DERECHA	6759	6759-KIT	

6759-KIT

6906

CONTINUACIÓN... LEON

	APLICACIÓN / DESCRIPTION	DAI PARTS #	DAI KIT PARTS #
BASES PARA AMORTIGUADOR / STRUT MOUNTS			
01-05	BALERO PARA BASE DE AMORTIGUADOR (1815)	6119	
06-13	BALERO PARA BASE DE AMORTIGUADOR FRONTAL IZQUIERDO Y DERECHO (7214)	6145	



	APLICACIÓN / DESCRIPTION	DAI PARTS #
CUBRE POLVOS / C.V. BOOTS		
01-05	CUBRE POLVO IZQUIERDO Y DERECHO LADO RUEDA	6305
	CUBRE POLVO IZQUIERDO Y DERECHO LADO CAJA	6302
	CUBRE POLVO IZQUIERDO Y DERECHO LADO CAJA	6382
	CUBRE POLVO IZQUIERDO Y DERECHO DE DIRECCIÓN	6374
06-12	CUBRE POLVO IZQUIERDO Y DERECHO LADO CAJA	63110
	CUBRE POLVO IZQUIERDO Y DERECHO LADO RUEDA	63111



CONTINUACIÓN... LEON

		APLICACIÓN / DESCRIPTION	DAI PARTS #	MISCELÁNEOS / AUTOMOTIVE RUBBER PARTS	
01-05		GOMA PARA BARRA ESTABILIZADORA 5/8"	6574		
		BUJES PARA HORQUILLA INFERIOR CHICO Y GRANDE (POLIURETANO KIT)	9800		
		BUJE PARA HORQUILLA INFERIOR POLIURETANO KIT CON CASQUILLO	9809		
		BUJE PARA HORQUILLA INFERIOR GRANDE (CON CEJA BUJE INTERNO CHICO)	64650		
		BUJE PARA HORQUILLA INFERIOR GRANDE (CON CEJA BUJE INTERNO GRANDE)	64651		
		GOMA PARA BARRA ESTABILIZADORA 3/4"	64709		
		BUJE PARA HORQUILLA INFERIOR GRANDE (SIN CEJA BUJE INTERO GRANDE)	64760		
		BUJE PARA EJE TRASERO IZQUIERDO Y DERECHO	DAI-1426037		
		TORNILLO ESTABILIZADOR FRONTAL DERECHO	DAI-2126002		
		BUJE PARA HORQUILLA CHICO	DAI-191-407-182		
		TORNILLO ESTABILIZADOR FRONTAL	DAI-1J0-411-315-C		
		BUJE PARA EJE TRASERO	DAI-1J0-501-541		

64760

DAI-1426037

DAI-2126002

DAI-191-407-182

DAI-1J0-411-315-C

DAI-1J0-501-541

CONTINUACIÓN... LEON

	28	APLICACIÓN / DESCRIPTION	DAI PARTS #
MISCELÁNEOS / AUTOMOTIVE RUBBER PARTS			
	06-12	BUJE PARA HORQUILLA INFERIOR CHICO	DAI-1426011
		TORNILLO ESTABILIZADOR FRONTAL	DAI-2126010
	14-15	BUJE PARA HORQUILLA INFERIOR GRANDE	DAI-1426023

**MISCELÁNEOS
AUTOMOTIVE RUBBER PARTS**

DAI-1426011

DAI-1426023



DAI-2126010

TOLEDO

SOPORTES / TRANSMISSION & MOTOR MOUNTS			
L4 1.8 L4 2.0	00-06	SOPORTE PARA MOTOR FRONTAL STD.	6658
		SOPORTE PARA MOTOR DERECHO	6659
		SOPORTE PARA TRANSMISIÓN STD.	6660
		SOPORTE PARA MOTOR DERECHO	6976-H
		SOPORTE PARA MOTOR TRASERO	6978
		SOPORTE PARA TRANSMISIÓN	6977
L4 2.0	01-05	SOPORTE PARA CARBURADOR	6823
	06-12	SOPORTE PARA TRANSMISIÓN AUT.	7211
		SOPORTE PARA TRANSMISIÓN STD. Y AUT.	7212
		SOPORTE PARA MOTOR TRASERO TORQUE STRUT	7254

**SOPORTES
TRANSMISSION & MOTOR MOUNTS**

6658

6659

6660

6823

6976-H

6977

6978

7211

7212

7254



CONTINUACIÓN... TOLEDO

 		APLICACIÓN / DESCRIPTION	DAI PARTS #
SOPORTES / TRANSMISSION & MOTOR MOUNTS			
L4 2.0	07-12	SOPORTE PARA MOTOR TRASERO SUPERIOR (CON CUERDA)	7194
		SOPORTE PARA MOTOR TRASERO INFERIOR (SIN CUERDA)	7195

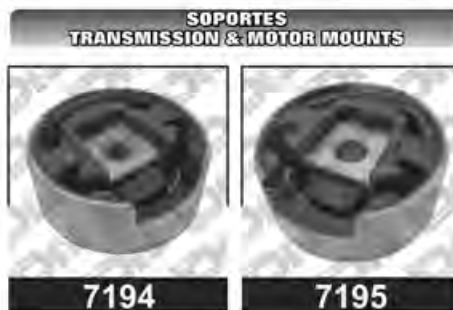

 		APLICACIÓN / DESCRIPTION	DAI PARTS #	DAI KIT PARTS #
BASES PARA AMORTIGUADOR / STRUT MOUNTS				
01-05		BASE PARA AMORTIGUADOR FRONTAL IZQUIERDA Y DERECHA	1815	1815-KIT
		BASE PARA AMORTIGUADOR TRASERA IZQUIERDA Y DERECHA	6906	
		BALERO PARA BASE DE AMORTIGUADOR	6119	
00-06		BASE PARA AMORTIGUADOR FRONTAL IZQUIERDA Y DERECHA	1816	
		BASE PARA AMORTIGUADOR FRONTAL IZQUIERDA Y DERECHA	6759	6759-KIT
06-12		BALERO PARA BASE DE AMORTIGUADOR FRONTAL IZQ. Y DER. (7214)	6145	



 28		APLICACIÓN / DESCRIPTION	DAI PARTS #
CUBRE POLVOS / C.V. BOOTS			
01-05		CUBRE POLVO IZQUIERDO Y DERECHO LADO RUEDA	6305
		CUBRE POLVO IZQUIERDO Y DERECHO DE DIRECCIÓN	6374
		CUBRE POLVO IZQUIERDO Y DERECHO LADO CAJA	6382
06-12		CUBRE POLVO IZQUIERDO Y DERECHO LADO CAJA	63110
		CUBRE POLVO IZQUIERDO Y DERECHO LADO RUEDA	63111



MISCELÁNEOS / AUTOMOTIVE RUBBER PARTS			
01-05		BUJES PARA HORQUILLA INFERIOR CHICO Y GRANDE (POLIURETANO KIT)	9800
		BUJES PARA HORQUILLA INFERIOR (POLIURETANO KIT CON CASQUILLO)	9809
		TORNILLO ESTABILIZADOR FRONTAL DERECHO	DAI-2126002
		TORNILLO ESTABILIZADOR FRONTAL	DAI-1J0-411-315-C



CONTINUACIÓN... TOLEDO

		APLICACIÓN / DESCRIPTION	DAI PARTS #	MISCELÁNEOS / AUTOMOTIVE RUBBER PARTS	
MISCELÁNEOS / AUTOMOTIVE RUBBER PARTS					
01-15		BUJE PARA HORQUILLA INFERIOR GRANDE (CON CEJA BUJE INTERNO CHICO)	64650		
		BUJE PARA HORQUILLA INFERIOR GRANDE (CON CEJA BUJE INTERNO GRANDE)	64651		
		BUJE PARA HORQUILLA INFERIOR GRANDE (SIN CEJA BUJE INTERNO GRANDE)	64760		
01-05 13-18		BUJE PARA EJE TRASERO IZQUIERDO Y DERECHO	DAI-1426037		
		BUJE PARA HORQUILLA CHICO	DAI-191-407-182		
		BUJE PARA EJE TRASERO	DAI-1J0-501-541		
06-12		BUJE PARA HORQUILLA INFERIOR CHICO	DAI-1426011		
		TORNILLO ESTABILIZADOR FRONTAL	DAI-2126010		
13-15		TORNILLO ESTABILIZADOR FRONTAL	DAI-2126004		



SUZUKI

AERIO

  28		APLICACIÓN / DESCRIPTION	DAI PARTS #
SOPORTES / TRANSMISSION & MOTOR MOUNTS			
L4 2.0 L4 2.3	04-07	SOPORTE PARA MOTOR TRASERO	7273
		SOPORTE PARA TRANSMISIÓN	7283
		SOPORTE PARA MOTOR TRASERO	7315
		SOPORTE PARA MOTOR DERECHO	7316



MISCELÁNEOS / AUTOMOTIVE RUBBER PARTS			
	02-06	TORNILLO ESTABILIZADOR	DAI-2124002
	02-07	TORNILLO ESTABILIZADOR FRONTAL IZQ. Y DER.	DAI-2124001



EQUATOR

 28		APLICACIÓN / DESCRIPTION	DAI PARTS #	DAI KIT PARTS #
BASES PARA AMORTIGUADOR / STRUT MOUNTS				
09-12		BASE PARA AMORTIGUADOR FRONTAL IZQUIERDA Y DERECHA		7634-KIT



GRAND VITARA

 		APLICACIÓN / DESCRIPTION	DAI PARTS #
SOPORTES / TRANSMISSION & MOTOR MOUNTS			
L4 2.4	06-15	SOPORTE PARA MOTOR IZQ. Y DER.	7797-H
V6 2.5	90-05	SOPORTE PARA MOTOR IZQUIERDO Y DERECHO	7306
	99-05	SOPORTE PARA TRANSMISIÓN	7269
V6 2.7	90-05	SOPORTE PARA MOTOR IZQUIERDO Y DERECHO	7306
	99-05	SOPORTE PARA TRANSMISIÓN	7269

**SOPORTES
TRANSMISSION & MOTOR MOUNTS**

7269

7306

7797-H
KIZASHI

MISCELÁNEOS / AUTOMOTIVE RUBBER PARTS			
	10-14	TORNILLO ESTABILIZADOR FRONTAL IZQ. Y DER.	DAI-2124001

**MISCELÁNEOS
AUTOMOTIVE RUBBER PARTS**

DAI-2124001
SIDEKICK

SOPORTES / TRANSMISSION & MOTOR MOUNTS			
L4 1.3	1989	SOPORTE PARA TRANSMISIÓN IZQUIERDO	7269
L4 1.6	89-98	SOPORTE PARA MOTOR FRONTAL	7261

**SOPORTES
TRANSMISSION & MOTOR MOUNTS**

7261

7269

CONTINUACIÓN... SIDEKICK

  28		APLICACIÓN / DESCRIPTION	DAI PARTS #
SOPORTES / TRANSMISSION & MOTOR MOUNTS			
L4 1.6	91-98	SOPORTE PARA MOTOR IZQUIERDO Y DERECHO	7432
L4 1.8	96-98	SOPORTE PARA TRANSMISIÓN	7269
		SOPORTE PARA TRANSMISIÓN IZQUIERDO	7306



  28		APLICACIÓN / DESCRIPTION	DAI PARTS #	DAI KIT PARTS #
BASES PARA AMORTIGUADOR / STRUT MOUNTS				
89-97		BASE PARA AMORTIGUADOR FRONTAL IZQUIERDA Y DERECHA		7295-KIT



SX-4

  28		APLICACIÓN / DESCRIPTION	DAI PARTS #
SOPORTES / TRANSMISSION & MOTOR MOUNTS			
L4 2.0	07-09	SOPORTE PARA MOTOR TRASERO	7713
		REPUESTO PARA SOPORTE DE MOTOR TRASERO (7713)	7713-9



CONTINUACIÓN... SX-4

 28		APLICACIÓN / DESCRIPTION	DAI PARTS #
SOPORTES / TRANSMISSION & MOTOR MOUNTS			
L4 2.0	07-09	SOPORTE PARA MOTOR FRONTAL	7714
		REPUESTO PARA SOPORTE DE MOTOR FRONTAL (7714)	7714-9
		SOPORTE PARA TRANSMISIÓN	7728
		SOPORTE PARA MOTOR DERECHO	7729

SWIFT



SOPORTES / TRANSMISSION & MOTOR MOUNTS			
L4 1.5 L4 1.6	05-11	SOPORTE PARA MOTOR TRASERO	7694
		SOPORTE PARA MOTOR DERECHO	7750
		SOPORTE PARA MOTOR FRONTAL	7751



MISCELÁNEOS / AUTOMOTIVE RUBBER PARTS		
05-14	TORNILLO ESTABILIZADOR	DAI-2124003



VARIOS

  28		APLICACIÓN / DESCRIPTION	DAI PARTS #
MISCELÁNEOS / AUTOMOTIVE RUBBER PARTS			
90-17		BUJE PARA MUELLE DELGADO LISO FRONTAL Y TRASERO (BALANCIN POLIURETANO)	9161
		BUJE PARA MUELLE GRUESO ESTRIADO FRONTAL Y TRASERO	9162



VITARA

SOPORTES / TRANSMISSION & MOTOR MOUNTS			
L4 1.6 L4 2.0	99-09	SOPORTE PARA TRANSMISIÓN STD.	7262
		SOPORTE PARA TRANSMISIÓN	7269
		SOPORTE PARA MOTOR IZQUIERDO Y DERECHO	7306







X-90

SOPORTES / TRANSMISSION & MOTOR MOUNTS			
L4 1.6	96-98	SOPORTE PARA MOTOR IZQUIERDO Y DERECHO	7432



XL-7

		 	APLICACIÓN / DESCRIPTION	DAI PARTS #	SOPORTES TRANSMISSION & MOTOR MOUNTS	
SOPORTES / TRANSMISSION & MOTOR MOUNTS						
L4 2.2	01-02		SOPORTE PARA TRANSMISIÓN	7269		
	02-06		SOPORTE PARA MOTOR IZQUIERDO Y DERECHO	7306		
V6 2.7	02-04		SOPORTE PARA MOTOR IZQUIERDO Y DERECHO	7306	7269	7306



TOYOTA

4 RUNNER

		28		APLICACIÓN / DESCRIPTION	DAI PARTS #
SOPORTES / TRANSMISSION & MOTOR MOUNTS					
L4 2.4	96-00	SOPORTE PARA MOTOR IZQUIERDO Y DERECHO		7690	
	84-86	SOPORTE PARA TRANSMISIÓN		7744	
L4 2.7	96-00	SOPORTE PARA MOTOR IZQUIERDO Y DERECHO		6859	
V6 3.0	88-95	SOPORTE PARA MOTOR IZQUIERDO Y DERECHO		6859	
		SOPORTE PARA MOTOR IZQUIERDO Y DERECHO		7690	
	93-94	SOPORTE PARA TRANSMISIÓN AUT.		7132	
V6 3.4	96-98	SOPORTE PARA MOTOR IZQUIERDO Y DERECHO		6859	
		SOPORTE PARA MOTOR IZQUIERDO Y DERECHO		7690	
	96-02	SOPORTE PARA TRANSMISIÓN AUT.		7132	
	99-02	SOPORTE PARA MOTOR IZQUIERDO Y DERECHO		7479	
V8 4.7	03-09	SOPORTE PARA TRANSMISIÓN 4X2		7742	

**SOPORTES
TRANSMISSION & MOTOR MOUNTS**



6859



7132



7479



7690



7742



7744

28		APLICACIÓN / DESCRIPTION	DAI PARTS #	DAI KIT PARTS #
BASES PARA AMORTIGUADOR / STRUT MOUNTS				
00-05	BASE PARA AMORTIGUADOR TRASERA IZQUIERDA Y DERECHA			7288-KIT

**BASES PARA AMORTIGUADOR
STRUT MOUNTS**



7288-KIT



CONTINUACIÓN... 4 RUNNER

		APLICACIÓN / DESCRIPTION	DAI PARTS #
MISCELÁNEOS / AUTOMOTIVE RUBBER PARTS			
	03-09	TORNILLO ESTABILIZADOR TRASERO	DAI-2125013

**MISCELÁNEOS
AUTOMOTIVE RUBBER PARTS**



DAI-2125013

AUTOS

MISCELÁNEOS / AUTOMOTIVE RUBBER PARTS			
		COPLÉ PARA DIRECCIÓN (SINFÍN DE .675" 2 PERNOS GRUESOS)	630
		GALLETA PARA DIRECCIÓN STD. Y HID. (2 PERNOS GRUESOS CON BUJES COMPLETO 619 Y 630)	641

**MISCELÁNEOS
AUTOMOTIVE RUBBER PARTS**



630



641

AVANZA

SOPORTES / TRANSMISSION & MOTOR MOUNTS			
L4 1.5	02-06	SOPORTE PARA TRANSMISIÓN	7754

**SOPORTES
TRANSMISSION & MOTOR MOUNTS**



7754



AVALON

  28		APLICACIÓN / DESCRIPTION	DAI PARTS #
SOPORTES / TRANSMISSION & MOTOR MOUNTS			
L4 2.5	13-16	SOPORTE PARA MOTOR FRONTAL DERECHO	7706
V6 3.0	95-96	REPUESTO PARA SOPORTE DE MOTOR TRASERO	7745-9
	97-99	SOPORTE PARA MOTOR DERECHO SUPERIOR TORQUE STRUT	7757
	05-06	SOPORTE PARA MOTOR FRONTAL DERECHO	7257-H
V6 3.5	08-12	SOPORTE PARA MOTOR FRONTAL DERECHO	7701
	08-16	SOPORTE PARA TRANSMISIÓN FRONTAL INFERIOR	7708
		SOPORTE PARA TRANSMISIÓN FRONTAL INFERIOR	7708-H
		SOPORTE PARA MOTOR FRONTAL INFERIOR IZQUIERDO	7725-H
	09-12	SOPORTE PARA MOTOR FRONTAL DERECHO	7257-H

**SOPORTES
TRANSMISSION & MOTOR MOUNTS**



7257-H



7701



7706



7708



7708-H



7725-H



7745-9



7757

MISCELÁNEOS / AUTOMOTIVE RUBBER PARTS			
	95-96	TOPE PARA AMORTIGUADOR FRONTAL IZQUIERDO Y DRECHO	D-0619
	05-12	TORNILLO ESTABILIZADOR FRONTAL	DAI-2125009

**MISCELÁNEOS
AUTOMOTIVE RUBBER PARTS**



D-0619



DAI-2125009



BJ-40

 		APLICACIÓN / DESCRIPTION	DAI PARTS #
MISCELÁNEOS / AUTOMOTIVE RUBBER PARTS			
		BUJE PARA MUELLE (POLIURETANO)	9127



BJ-70

MISCELÁNEOS / AUTOMOTIVE RUBBER PARTS			
		BUJE PARA MUELLE (POLIURETANO)	9128



CAMIONETAS

MISCELÁNEOS / AUTOMOTIVE RUBBER PARTS			
		BUJE PARA BRAZO SUPERIOR (POLIURETANO (4X4))	9173



CAMRY

		APLICACIÓN / DESCRIPTION	DAI PARTS #
--	--	--------------------------	-------------

SOPORTES / TRANSMISSION & MOTOR MOUNTS

L4 2.2	92-96	SOPORTE PARA MOTOR FRONTAL AUT.	7758
	92-01	SOPORTE PARA MOTOR DERECHO SUPERIOR TORQUE STRUT	7703
	98-99	SOPORTE PARA MOTOR TRASERO	6945
		SOPORTE PARA TRANSMISIÓN	6946
	92-06	SOPORTE PARA MOTOR FRONTAL	7256-H
	10-16	SOPORTE PARA MOTOR DERECHO SUPERIOR TORSION TORQUE STRUT	7530

L4 2.4	02-06	SOPORTE PARA MOTOR FRONTAL	7793
	02-09	SOPORTE PARA MOTOR FRONTAL DERECHO	7257-H
		SOPORTE PARA MOTOR FRONTAL	7256-H
		SOPORTE PARA MOTOR DERECHO SUPERIOR	7264
	2009	SOPORTE PARA TRANSMISIÓN FRONTAL INFERIOR	7708
		SOPORTE PARA TRANSMISIÓN FRONTAL INFERIOR	7708-H

L4 2.5	10-11	SOPORTE PARA TRANSMISIÓN FRONTAL INFERIOR	7708
		SOPORTE PARA TRANSMISIÓN FRONTAL INFERIOR	7708-H
	12-16	SOPORTE PARA MOTOR FRONTAL DERECHO	7706

**SOPORTES
TRANSMISSION & MOTOR MOUNTS**



6945 **6946**



7256-H **7257-H**



7264 **7530**



7703 **7706**



7708 **7708-H** **7758** **7793**



CONTINUACIÓN... CAMRY

 28		APLICACIÓN / DESCRIPTION	DAI PARTS #
SOPORTES / TRANSMISSION & MOTOR MOUNTS			
V6 3.0	1992-04-06	REPUESTO PARA SOPORTE DE TORSIÓN	7440-9
	1992	SOPORTE PARA MOTOR DERECHO SUPERIOR TORQUE STRUT	7660
	92-02	REPUESTO PARA SOPORTE DE MOTOR TRASERO	7745-9
	92-06	SOPORTE PARA MOTOR FRONTAL	7256-H
	97-01	SOPORTE PARA MOTOR DERECHO SUPERIOR TORQUE STRUT	7757
		REPUESTO PARA SOPORTE DE MOTOR TRASERO	7782-9
	02-06	SOPORTE PARA MOTOR FRONTAL DERECHO	7257-H
V6 3.3	04-06	SOPORTE PARA MOTOR FRONTAL	7793
	04-07	SOPORTE PARA MOTOR FRONTAL DERECHO	7257-H
		SOPORTE PARA MOTOR DERECHO SUPERIOR TORQUE STRUT	7660
	04-09	REPUESTO PARA SOPORTE DE TORSIÓN	7440-9
V6 3.5	04-11	SOPORTE PARA MOTOR FRONTAL DERECHO	7257-H
	07-11	SOPORTE PARA MOTOR FRONTAL DERECHO	7701
	07-16	SOPORTE PARA TRANSMISIÓN FRONTAL INFERIOR	7708
		SOPORTE PARA TRANSMISIÓN FRONTAL INFERIOR	7708-H
		SOPORTE PARA MOTOR FRONTAL INFERIOR IZQUIERDO	7725-H
V6 3.6	04-06	REPUESTO PARA SOPORTE DE TORSIÓN	7440-9

**SOPORTES
TRANSMISSION & MOTOR MOUNTS**

7256-H
7257-H

7440-9
7660

7701
7708

7708-H
7725-H

7745-9
7757
7782-9
7793

CONTINUACIÓN... CAMRY

28	APLICACIÓN / DESCRIPTION	DAI PARTS #	DAI KIT PARTS #
BASES PARA AMORTIGUADOR / STRUT MOUNTS			
91-03	BASE AMORTIGUADOR FRONTAL DERECHA		7232-KIT
	BASE AMORTIGUADOR FRONTAL IZQUIERDA		7231-KIT
02-06	BASE AMORTIGUADOR FRONTAL DERECHA		7327-KIT
92-06	BASE AMORTIGUADOR TRASERA IZQUIERDA Y DERECHA		7374-KIT



28	APLICACIÓN / DESCRIPTION	DAI PARTS #
MISCELÁNEOS / AUTOMOTIVE RUBBER PARTS		
92-01	BUJE INFERIOR CHICO	DAI-1425010
	BUJE PARA HORQUILLA GRANDE	DAI-48655-07010
92-06	TOPE PARA AMORTIGUADOR FRONTAL IZQUIERDO Y DERECHO	D-0619
02-06	TORNILLO ESTABILIZADOR TRASERO	DAI-2125001
	TORNILLO ESTABILIZADOR FRONTAL	DAI-2125009



CELICA

 		APLICACIÓN / DESCRIPTION	DAI PARTS #
SOPORTES / TRANSMISSION & MOTOR MOUNTS			
L4 2.0	72-74	SOPORTE PARA TRANSMISIÓN AUT.	7132
L4 2.2	75-80	SOPORTE PARA TRANSMISIÓN	7132
L4 2.4	1981	SOPORTE PARA TRANSMISIÓN	7132

**SOPORTES
TRANSMISSION & MOTOR MOUNTS**

7132
COASTER

MISCELÁNEOS / AUTOMOTIVE RUBBER PARTS		
87-04	BUJE PARA MUELLE TRASERO Y FRONTAL (POLIURETANO)	9166

**MISCELÁNEOS
AUTOMOTIVE RUBBER PARTS**

9166
COROLLA

SOPORTES / TRANSMISSION & MOTOR MOUNTS			
L4 1.6	77-79	SOPORTE PARA TRANSMISIÓN AUT.	7132
	83-87		
	93-97	SOPORTE PARA MOTOR TRASERO	7696
L4 1.8	80-82	SOPORTE PARA TRANSMISIÓN AUT.	7132
	93-97	SOPORTE PARA MOTOR TRASERO	7696
	98-02	SOPORTE PARA MOTOR TRASERO AUT.	7755
		SOPORTE PARA MOTOR DERECHO	7780-H
	02-07	SOPORTE PARA MOTOR FRONTAL	7133
03-08	REPUESTO PARA SOPORTE DE MOTOR TRASERO (7134)	7134-9	

**SOPORTES
TRANSMISSION & MOTOR MOUNTS**

7132

7133

7134-9

7696

7755
7780-H

CONTINUACIÓN... COROLLA

			APLICACIÓN / DESCRIPTION	DAI PARTS #
SOPORTES / TRANSMISSION & MOTOR MOUNTS				
L4 1.8	03-08		SOPORTE PARA MOTOR TRASERO	7134
	06-10		SOPORTE PARA TRANSMISIÓN	7135
			SOPORTE PARA MOTOR DERECHO	7142-H
	06-13		REPUESTO PARA SOPORTE DE TRANSMISIÓN (7135)	7201-9
	08-13		SOPORTE PARA MOTOR FRONTAL	7534
	09-13		SOPORTE PARA MOTOR TRASERO	7674
	09-16		SOPORTE PARA MOTOR DERECHO	7695
		SOPORTE PARA TRANSMISIÓN STD.	7641	
L4 2.4	09-10		SOPORTE PARA MOTOR FRONTAL DERECHO	7257-H



			APLICACIÓN / DESCRIPTION	DAI PARTS #	DAI KIT PARTS #
BASES PARA AMORTIGUADOR / STRUT MOUNTS					
03-11			BASE PARA AMORTIGUADOR FRONTAL IZQUIERDA Y DERECHA		7320-KIT
03-08			BASE PARA AMORTIGUADOR TRASERA DERECHA		7325-KIT



			APLICACIÓN / DESCRIPTION	DAI PARTS #
MISCELÁNEOS / AUTOMOTIVE RUBBER PARTS				
	03-17		TORNILLO ESTABILIZADOR FRONTAL	DAI-2125008



CORONA

  28		APLICACIÓN / DESCRIPTION	DAI PARTS #
SOPORTES / TRANSMISSION & MOTOR MOUNTS			
L4 2.0	72-82	SOPORTE PARA TRANSMISIÓN	7132
L4 2.2	72-82	SOPORTE PARA TRANSMISIÓN	7132
L4 2.4	72-82	SOPORTE PARA TRANSMISIÓN	7132

**SOPORTES
TRANSMISSION & MOTOR MOUNTS**

7132
CROW

MISCELÁNEOS / AUTOMOTIVE RUBBER PARTS			
		BUJE PARA TORNILLO (TENSOR POLIURETANO)	9168

**MISCELÁNEOS
AUTOMOTIVE RUBBER PARTS**

9168
ECHO

SOPORTES / TRANSMISSION & MOTOR MOUNTS			
L4 1.5	99-05	SOPORTE PARA MOTOR TRASERO	7433
		SOPORTE PARA MOTOR DERECHO	7435

**SOPORTES
TRANSMISSION & MOTOR MOUNTS**

7433



7435

 28		APLICACIÓN / DESCRIPTION	DAI PARTS #	DAI KIT PARTS #
BASES PARA AMORTIGUADOR / STRUT MOUNTS				
00-02		BASE PARA AMORTIGUADOR FRONTAL IZQUIERDA Y DERECHA		7595-KIT

**BASES PARA AMORTIGUADOR
STRUT MOUNTS**

7595-KIT

FJ CRUISER

  28		APLICACIÓN / DESCRIPTION	DAI PARTS #
MISCELÁNEOS / AUTOMOTIVE RUBBER PARTS			
	07-08	TORNILLO ESTABILIZADOR TRASERO	DAI-2125013

MISCELÁNEOS AUTOMOTIVE RUBBER PARTS



DAI-2125013

HIACE

SOPORTES / TRANSMISSION & MOTOR MOUNTS			
L4 2.7	05-12	SOPORTE PARA TRANSMISIÓN	7309
		SOPORTE PARA MOTOR IZQUIERDO Y DERECHO	7326

SOPORTES TRANSMISSION & MOTOR MOUNTS



7309



7326

MISCELÁNEOS / AUTOMOTIVE RUBBER PARTS			
	04-12	BUJE PARA HORQUILLA SUPERIOR CHICO	DAI-1425023
	04-15	GOMAS PARA TIRANTE DE SUSPENSIÓN IZQUIERDO Y DERECHOS EN POLIURETANO	9803

MISCELÁNEOS AUTOMOTIVE RUBBER PARTS



9803



DAI-1425023

HIGHLANDER

SOPORTES / TRANSMISSION & MOTOR MOUNTS			
L4 2.4	01-03	SOPORTE PARA MOTOR DERECHO SUPERIOR TORQUE STRUT LARGO 4X4	7732
		SOPORTE PARA MOTOR DERECHO SUPERIOR TORQUE STRUT CORTO 4X2	7733

SOPORTES TRANSMISSION & MOTOR MOUNTS



7732



7733



CONTINUACIÓN... HIGHLANDER

			APLICACIÓN / DESCRIPTION	DAI PARTS #
SOPORTES / TRANSMISSION & MOTOR MOUNTS				
L4 2.4	01-03	SOPORTE PARA MOTOR DERECHO SUPERIOR TORQUE STRUT		7738
	01-07	SOPORTE PARA MOTOR FRONTAL DERECHO		7257-H
		REPUESTO PARA SOPORTE DE TORSIÓN		7440-9
		SOPORTE PARA MOTOR FRONTAL		7535
L4 2.7	09-16	SOPORTE PARA TRANSMISIÓN FRONTAL INFERIOR		7708
		SOPORTE PARA TRANSMISIÓN FRONTAL INFERIOR		7708-H
V6 3.0	01-03	SOPORTE PARA MOTOR FRONTAL DERECHO		7257-H
		REPUESTO PARA SOPORTE DE TORSIÓN		7440-9
V6 3.3	04-07	REPUESTO PARA SOPORTE DE TORSIÓN		7440-9
	04-09	SOPORTE PARA MOTOR FRONTAL DERECHO		7257-H
	08-13	SOPORTE PARA TRANSMISIÓN FRONTAL INFERIOR		7708
		SOPORTE PARA TRANSMISIÓN FRONTAL INFERIOR		7708-H
V6 3.5	08-10	SOPORTE PARA MOTOR DERECHO SUPERIOR TORQUE STRUT		7769
	08-16	SOPORTE PARA TRANSMISIÓN FRONTAL INFERIOR		7708
		SOPORTE PARA TRANSMISIÓN FRONTAL INFERIOR		7708-H
	10-15	SOPORTE PARA MOTOR FRONTAL DERECHO		7701
	14-15	SOPORTE PARA MOTOR FRONTAL DERECHO		7257-H



CONTINUACIÓN... HIGHLANDER

28	APLICACIÓN / DESCRIPTION	DAI PARTS #	DAI KIT PARTS #
BASES PARA AMORTIGUADOR / STRUT MOUNTS			
01-03	BASE PARA AMORTIGUADOR TRASERA IZQUIERDA Y DERECHA		7374-KIT
01-07	BASE PARA AMORTIGUADOR FRONTAL IZQUIERDA Y DERECHA		7378-KIT



28	APLICACIÓN / DESCRIPTION	DAI PARTS #
MISCELÁNEOS / AUTOMOTIVE RUBBER PARTS		
01-07	TORNILLO ESTABILIZADOR TRASERO	DAI-2125001
01-12	TORNILLO ESTABILIZADOR FRONTAL	DAI-2125009



HILUX

SOPORTES / TRANSMISSION & MOTOR MOUNTS			
L4 2.7	04-12	SOPORTE PARA MOTOR IZQUIERDO Y DERECHO	7131
	04-13	SOPORTE PARA TRANSMISIÓN	7132
	13-16	SOPORTE PARA MOTOR IZQUIERDO Y DERECHO	7642



CONTINUACIÓN... HILUX

 28		APLICACIÓN / DESCRIPTION	DAI PARTS #
MISCELÁNEOS / AUTOMOTIVE RUBBER PARTS			
		GOMA PARA AMORTIGUADOR (11/4" x 4/16" POLIURETANO)	9165
1986		GOMA PARA BARRA ESTABILIZADORA (POLIURETANO)	9171
04-05		BUJES PARA HORQUILLA SUPERIOR (4X2)	DAI-K-9210
04-12		BUJE PARA MUELLE (POLIURETANO BALANCIN)	9158
		BUJE PARA TORNILLO (TENSOR POLIURETANO)	9168

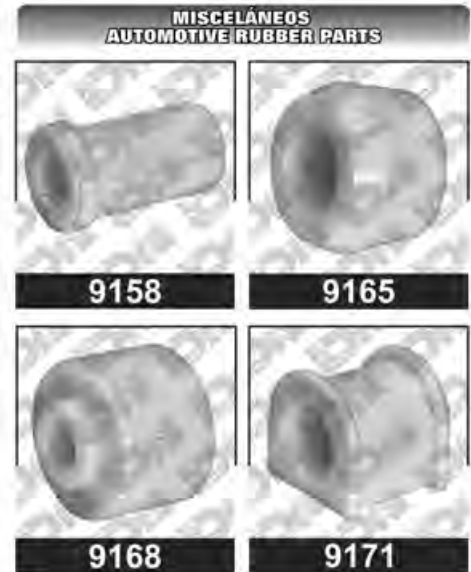
DAI-K-9210

HJ-45



MISCELÁNEOS / AUTOMOTIVE RUBBER PARTS			
		BUJE PARA MUELLE (POLIURETANO)	9131

LAND CRUISER

MISCELÁNEOS / AUTOMOTIVE RUBBER PARTS			
		GOMA PARA AMORTIGUADOR (POLIURETANO)	9163



LN-65

 		APLICACIÓN / DESCRIPTION	DAI PARTS #
MISCELÁNEOS / AUTOMOTIVE RUBBER PARTS			
04-09		BUJE PARA MUELLE (POLIURETANO BALANCIN)	9158

**MISCELÁNEOS
AUTOMOTIVE RUBBER PARTS**



9158

MATRIX

SOPORTES / TRANSMISSION & MOTOR MOUNTS			
L4 1.8	03-08	SOPORTE PARA MOTOR TRASERO	7134
		REPUESTO PARA SOPORTE DE MOTOR TRASERO (7134)	7134-9
		SOPORTE PARA MOTOR FRONTAL	7534
	06-10	SOPORTE PARA MOTOR FRONTAL	7133
		SOPORTE PARA TRANSMISIÓN	7135
		SOPORTE PARA MOTOR DERECHO	7142-H
		REPUESTO PARA SOPORTE DE TRANSMISIÓN (7135, 7641)	7201-9
		SOPORTE PARA MOTOR TRASERO	7674
	09-13	SOPORTE PARA MOTOR DERECHO	7695
SOPORTE PARA TRANSMISIÓN STD.		7641	

**SOPORTES
TRANSMISSION & MOTOR MOUNTS**



7133



7134



7134-9



7135



7142-H



7201-9



7534



7641



7674



7695



CONTINUACIÓN... MATRIX

28		APLICACIÓN / DESCRIPTION	DAI PARTS #	DAI KIT PARTS #
BASES PARA AMORTIGUADOR / STRUT MOUNTS				
03-08		BASE PARA AMORTIGUADOR FRONTAL IZQUIERDA Y DERECHA		7320-KIT
		BASE PARA AMORTIGUADOR TRASERA IZQUIERDA Y DERECHA		7325-KIT



28		APLICACIÓN / DESCRIPTION	DAI PARTS #
MISCELÁNEOS / AUTOMOTIVE RUBBER PARTS			
	03-08	TORNILLO ESTABILIZADOR FRONTAL	DAI-2125008



PICK UP

SOPORTES / TRANSMISSION & MOTOR MOUNTS			
L4 2.2	78-83	SOPORTE PARA TRANSMISIÓN AUT.	7132
		SOPORTE PARA TRANSMISION 4X4	7744
L4 2.4	81-88	SOPORTE PARA TRANSMISION 4X4	7744
	84-95	SOPORTE PARA TRANSMISIÓN AUT.	7132
	92-95	SOPORTE PARA MOTOR IZQUIERDO Y DERECHO	7690
V6 3.0	88-95	SOPORTE PARA TRANSMISIÓN AUT.	7132
		SOPORTE PARA MOTOR IZQUIERDO Y DERECHO	6859
		SOPORTE PARA MOTOR IZQUIERDO Y DERECHO	7690

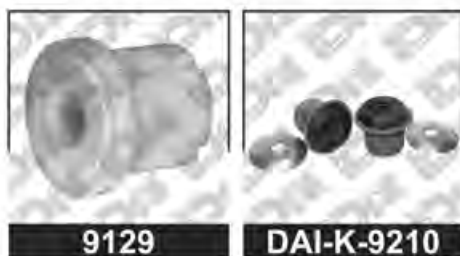
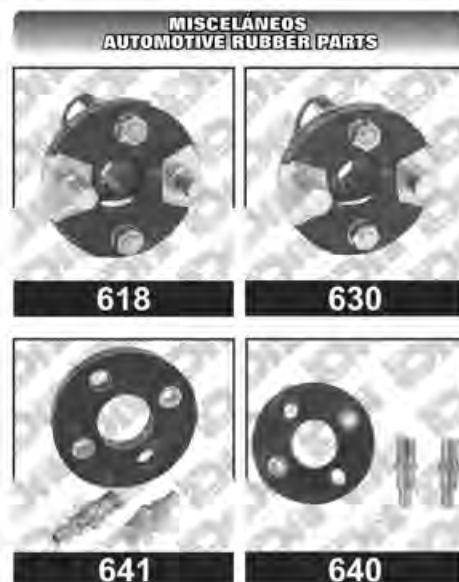

CONTINUACIÓN... PICK UP

  28		APLICACIÓN / DESCRIPTION	DAI PARTS #
MISCELÁNEOS / AUTOMOTIVE RUBBER PARTS			
		COPE PARA DIRECCIÓN (SINFÍN DE .675" 2 PERNOS GRUESOS)	630
		GALLETAS PARA DIRECCIÓN STD. Y HID. (2 PERNOS GRUESOS CON BUJES COMPLETO 619 Y 630)	641
	78-95	COPE PARA DIRECCIÓN (SINFÍN DE .675" 2 PERNOS DELGADOS)	618
		GALLETAS PARA DIRECCIÓN STD. Y HID. (2 PERNOS DELGADOS CON BUJES COMPLETO 618)	640
	81-90	BUJE PARA MUELLE (POLIURETANO)	9129
	84-94	BUJES PARA HORQUILLA SUPERIOR	DAI-K-9210



PICK UP 22-R

CUBRE POLVOS / C.V. BOOTS			
	84-96	CUBRE POLVO IZQUIERDO Y DERECHO LADO CAJA (4X4)	6339
		CUBRE POLVO IZQUIERDO Y DERECHO LADO RUEDA	6340



PRIUS-C

28	APLICACIÓN / DESCRIPTION	DAI PARTS #	DAI KIT PARTS #
BASES PARA AMORTIGUADOR / STRUT MOUNTS			
12-15	BASE PARA AMORTIGUADOR FRONTAL IZQUIERDA Y DERECHA		7592-KIT

**BASES PARA AMORTIGUADOR
STRUT MOUNTS**

7592-KIT
RAV-4

28	APLICACIÓN / DESCRIPTION	DAI PARTS #	
SOPORTES / TRANSMISSION & MOTOR MOUNTS			
L4 2.0	96-97	SOPORTE PARA TRANSMISIÓN 4X4	7619
	00-04	SOPORTE PARA MOTOR FRONTAL	7263
		SOPORTE PARA MOTOR TRASERO	7307
	01-03	SOPORTE PARA MOTOR TRASERO	7668
		SOPORTE PARA TRANSMISIÓN	7620
L4 2.4	04-05	SOPORTE PARA MOTOR DERECHO	7533-H
	04-08	SOPORTE PARA MOTOR TRASERO 4X4	7666
	06-08	SOPORTE PARA MOTOR DERECHO	7456-H
		SOPORTE PARA TRANSMISIÓN	7500
		SOPORTE PARA MOTOR TRASERO (4X2)	7536

**SOPORTES
TRANSMISSION & MOTOR MOUNTS**

7263

7307

7456-H

7500

7619
7620
7666
7668

7533-H

7536

CONTINUACIÓN... RAV-4

		 28		APLICACIÓN / DESCRIPTION	DAI PARTS #
SOPORTES / TRANSMISSION & MOTOR MOUNTS					
L4 2.5	04-05	SOPORTE PARA TRANSMISIÓN		7620	
	06-10	REPUESTO SOPORTE DE TRANSMISIÓN		7201-9	
		SOPORTE PARA MOTOR FRONTAL		7457	
	09-12	SOPORTE PARA TRANSMISIÓN		7500	
		SOPORTE PARA MOTOR TRASERO (4X2)		7536	
		SOPORTE PARA MOTOR TRASERO 4X4		7666	
	09-16	SOPORTE PARA MOTOR FRONTAL		7726	
	13-14	SOPORTE PARA MOTOR TRASERO		7667	
13-17	SOPORTE PARA TRANSMISIÓN		7628		
V6 3.5	06-12	REPUESTO SOPORTE DE TRANSMISIÓN		7201-9	

**SOPORTES
TRANSMISSION & MOTOR MOUNTS**



7201-9



7457



7500



7536



7620



7628



7666



7667



7726

 28		APLICACIÓN / DESCRIPTION	DAI PARTS #	DAI KIT PARTS #
BASES PARA AMORTIGUADOR / STRUT MOUNTS				
01-05	BASE PARA AMORTIGUADOR FRONTAL IZQUIERDA Y DERECHA			7292-KIT
	BASE PARA AMORTIGUADOR FRONTAL IZQUIERDA Y DERECHA			7598-KIT

**BASES PARA AMORTIGUADOR
STRUT MOUNTS**



7292-KIT



7598-KIT



CONTINUACIÓN... RAV-4

 28		APLICACIÓN / DESCRIPTION	DAI PARTS #
MISCELÁNEOS / AUTOMOTIVE RUBBER PARTS			
01-05		TOPE PARA AMORTIGUADOR FRONTAL IZQUIERDO Y DERECHO	D-0619
		TORNILLO ESTABILIZADOR FRONTAL	DAI-2125002

SCION-XD

 28		APLICACIÓN / DESCRIPTION	DAI PARTS #	DAI KIT PARTS #
BASES PARA AMORTIGUADOR / STRUT MOUNTS				
06-14		BASE PARA AMORTIGUADOR FRONTAL IZQUIERDA Y DERECHA		7592-KIT

SIENNA

 28		APLICACIÓN / DESCRIPTION	DAI PARTS #
SOPORTES / TRANSMISSION & MOTOR MOUNTS			
L4 2.7	08-13	SOPORTE PARA TRANSMISIÓN FRONTAL INFERIOR	7708
		SOPORTE PARA TRANSMISIÓN FRONTAL INFERIOR	7708-H
V6 3.0	98-03	SOPORTE PARA MOTOR DERECHO SUPERIOR TORQUE STRUT	7664
		REPUESTO PARA SOPORTE DE MOTOR TRASERO	7782-9



CONTINUACIÓN... SIENNA

 		APLICACIÓN / DESCRIPTION	DAI PARTS #
SOPORTES / TRANSMISSION & MOTOR MOUNTS			
V6 3.3	04-06	SOPORTE PARA MOTOR FRONTAL	7256-H
		REPUESTO PARA SOPORTE DE TORSIÓN	7440-9
	04-09	SOPORTE PARA MOTOR FRONTAL DERECHO	7257-H
V6 3.5	07-11	REPUESTO PARA SOPORTE DE TORSIÓN	7428-9
	07-15	SOPORTE PARA MOTOR FRONTAL DERECHO	7257-H
	11-14	SOPORTE PARA MOTOR DERECHO SUPERIOR TORQUE STRUT (4X2)	7588
	11-16	SOPORTE PARA TRANSMISIÓN FRONTAL INFERIOR	7708
		SOPORTE PARA TRANSMISIÓN FRONTAL INFERIOR	7708-H
		SOPORTE PARA MOTOR FRONTAL IZQUIERDO	7725-H
	14-16	SOPORTE PARA MOTOR FRONTAL DERECHO	7701



		APLICACIÓN / DESCRIPTION	DAI PARTS #	DAI KIT PARTS #
BASES PARA AMORTIGUADOR / STRUT MOUNTS				
91-03		BASE PARA AMORTIGUADOR FRONTAL IZQUIERDA		7231-KIT
		BASE PARA AMORTIGUADOR FRONTAL DERECHA		7232-KIT



CONTINUACIÓN... SIENNA

	28	APLICACIÓN / DESCRIPTION	DAI PARTS #
MISCELÁNEOS / AUTOMOTIVE RUBBER PARTS			
	04-10	TORNILLO ESTABILIZADOR FRONTAL	DAI-2125009

**MISCELÁNEOS
AUTOMOTIVE RUBBER PARTS**

DAI-2125009
SOLARA

SOPORTES / TRANSMISSION & MOTOR MOUNTS			
L4 2.2	99-01	SOPORTE PARA MOTOR DERECHO SUPERIOR TORSIÓN TORQUE STRUT	7703
L4 2.4	04-08	SOPORTE PARA MOTOR FRONTAL DERECHO	7257-H
		SOPORTE PARA MOTOR FRONTAL DERECHO	7264
		SOPORTE PARA MOTOR FRONTAL	7793
V6 3.0	99-03	REPUESTO PAR SOPORTE DE MOTOR TRASERO	7745-9
		SOPORTE PARA MOTOR DERECHO SUPERIOR TORSIÓN TORQUE STRUT	7703
		SOPORTE PARA MOTOR DERECHO SUPERIOR TORQUE STRUT	7757
		REPUESTO PARA SOPORTE DE MOTOR TRASERO	7782-9
V6 3.3	04-08	SOPORTE PARA MOTOR FRONTAL DERECHO	7257-H
		SOPORTE PARA MOTOR FRONTAL DERECHO	7264

**SOPORTES
TRANSMISSION & MOTOR MOUNTS**

7257-H

7264

7703

7745-9

7757

7782-9

7793

CONTINUACIÓN... SOLARA

 		APLICACIÓN / DESCRIPTION	DAI PARTS #
SOPORTES / TRANSMISSION & MOTOR MOUNTS			
V6 3.3	04-08	REPUESTO PARA SOPORTE DE TORSIÓN	7440-9
		SOPORTE PARA MOTOR DERECHO SUPERIOR TORSIÓN	7660
		SOPORTE PARA MOTOR FRONTAL	7793



 		APLICACIÓN / DESCRIPTION	DAI PARTS #
MISCELÁNEOS / AUTOMOTIVE RUBBER PARTS			
	04-08	TORNILLO ESTABILIZADOR TRASERO	DAI-2125001



T 100

SOPORTES / TRANSMISSION & MOTOR MOUNTS			
L4 2.7	94-98	SOPORTE PARA MOTOR IZQUIERDO Y DERECHO	6859
		SOPORTE PARA TRANSMISIÓN	7132
V6 3.0	93-98	SOPORTE PARA TRANSMISIÓN	7132



CONTINUACIÓN... T 100

 		APLICACIÓN / DESCRIPTION	DAI PARTS #
SOPORTES / TRANSMISSION & MOTOR MOUNTS			
V6 3.0	93-94	SOPORTE PARA MOTOR IZQUIERDO Y DERECHO	7690
V6 3.4	95-98	SOPORTE PARA TRANSMISIÓN	7132
		SOPORTE PARA MOTOR IZQUIERDO Y DERECHO	7690

TACOMA



SOPORTES / TRANSMISSION & MOTOR MOUNTS			
L4 2.4	98-04	SOPORTE PARA TRANSMISIÓN TRACCIÓN TRASERA	7132
	95-04	SOPORTE PARA MOTOR IZQUIERDO Y DERECHO	6859
L4 2.7	95-04	SOPORTE PARA MOTOR IZQUIERDO Y DERECHO	6859
	98-04	SOPORTE PARA TRANSMISIÓN TRACCIÓN TRASERA	7132
V6 3.4	95-99	SOPORTE PARA MOTOR IZQUIERDO Y DERECHO	7690
	00-04	SOPORTE PARA MOTOR IZQUIERDO Y DERECHO	7479
	06-07	SOPORTE PARA TRANSMISIÓN TRACCIÓN TRASERA	7132



CUBRE POLVOS / C.V. BOOTS			
	95-09	CUBRE POLVO IZQUIERDO Y DERECHO LADO CAJA (4X2) Y (4X4) (CON TRIPOIDE)	63113



CONTINUACIÓN... TACOMA

	 28	APLICACIÓN / DESCRIPTION	DAI PARTS #
CUBRE POLVOS / C.V. BOOTS			
	95-09	CUBRE POLVO IZQUIERDO Y DERECHO LADO RUEDA	63114



MISCELÁNEOS / AUTOMOTIVE RUBBER PARTS			
	95-04	BUJES PARA HORQUILLA SUPERIOR (4X2)	DAI-1425026
	96-04	BUJE PARA HORQUILLA INFERIOR (4X2)	DAI-1425027



TERCEL

SOPORTES / TRANSMISSION & MOTOR MOUNTS			
L4 1.5	87-90	SOPORTE PARA TRANSMISIÓN AUT.	6860



VARIOS

	28	APLICACIÓN / DESCRIPTION	DAI PARTS #
MISCELÁNEOS / AUTOMOTIVE RUBBER PARTS			
		COPLÉ PARA DIRECCIÓN (SINFÍN DE 675" 2 PERNOS DELGADOS)	618
		GALLETA PARA DIRECCIÓN STD. Y HID. (2 PERNOS DELGADOS CON BUJES COMPLETO 618)	640

VENZA

SOPORTES / TRANSMISSION & MOTOR MOUNTS			
V6 3.5	09-15	SOPORTE PARA MOTOR FRONTAL INFERIOR IZQUIERDO	7725-H
	10-15	SOPORTE PARA MOTOR FRONTAL DERECHO	7257-H
		SOPORTE PARA MOTOR FRONTAL DERECHO	7701

YARIS

SOPORTES / TRANSMISSION & MOTOR MOUNTS			
L4 1.3	99-05	SOPORTE PARA MOTOR TRASERO	7433
		SOPORTE PARA MOTOR DERECHO	7435



CONTINUACIÓN... YARIS

  28		APLICACIÓN / DESCRIPTION	DAI PARTS #
SOPORTES / TRANSMISSION & MOTOR MOUNTS			
L4 1.5	06-11	SOPORTE PARA TRANSMISIÓN STD.	7201
		SOPORTE PARA MOTOR TASERO STD.	7204
		REPUESTO PARA SOPORTE DE TRANSMISIÓN (7201)	7201-9
		SOPORTE PARA MOTOR TRASERO AUT.	7419
		COMPLEMENTO PARA SOPORTE DE MOTOR TRASERO AUT. (7419)	7522
	12-16	SOPORTE PARA MOTOR DERECHO STD.	7669-H
13-16	SOPORTE PARA MOTOR DERECHO AUT.	7705-H	



  28		APLICACIÓN / DESCRIPTION	DAI PARTS #	DAI KIT PARTS #
BASES PARA AMORTIGUADOR / STRUT MOUNTS				
99-05		BASE PARA AMORTIGUADOR FRONTAL IZQUIERDA Y DERECHA		7595-KIT
06-14		BASE PARA AMORTIGUADOR FRONTAL IZQUIERDA Y DERECHA		7592-KIT



  28		APLICACIÓN / DESCRIPTION	DAI PARTS #
MISCELÁNEOS / AUTOMOTIVE RUBBER PARTS			
	06-11	TORNILLO ESTABILIZADOR FRONTAL	DAI-2125019



UNIVERSAL

VARIOS

	 28	APLICACIÓN / DESCRIPTION	DAI PARTS #
MISCELÁNEOS / AUTOMOTIVE RUBBER PARTS			
		GOMA PARA AMORTIGUADOR CÓNICA	31
		GOMA PARA AMORTIGUADOR CÓNICA	32
		GOMA PARA AMORTIGUADOR CILINDRICA	50
		RONDANA METALICA PARA GOMAS DE AMORTIGUADOR	54
		GOMA PARA AMORTIGUADOR	64
		GOMA PARA AMORTIGUADOR CILINDRICA	71
		CAPUCHON PARA CABLE DE BUJIAS LADO DISTRIBUIDOR	81
		CAPUCHON PARA CABLE DE BUJIAS LADO BUJIA	83
		CAPUCHON PARA CABLE DE BUJIAS LADO BOBINA	84
		TOPE PARA SUSPENSIÓN	358
		CALZA PARA RESORTE	400
		CALZA PARA RESORTE	401
		CALZA PARA RESORTE (TIPO NUEVO)	402
		CALZA PARA RESORTE (TIPO NUEVO)	403

MISCELÁNEOS AUTOMOTIVE RUBBER PARTS

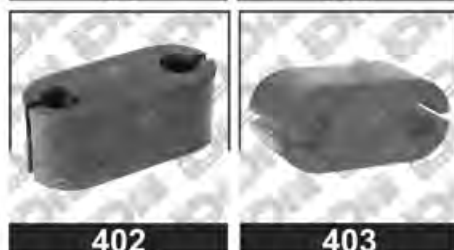
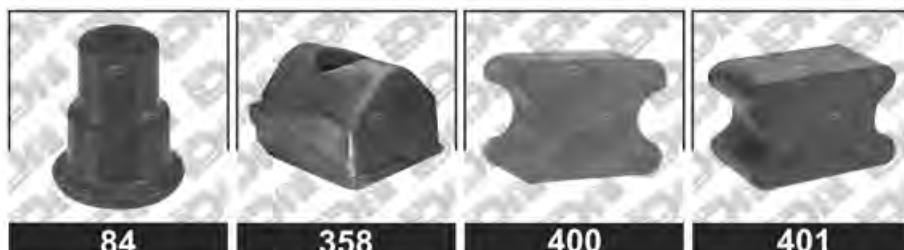
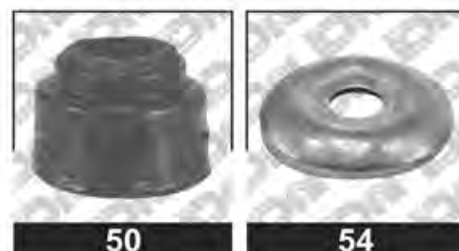
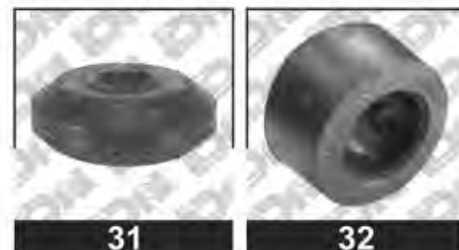

CONTINUACIÓN... VARIOS

		28	APLICACIÓN / DESCRIPTION	DAI PARTS #	MISCELÁNEOS / AUTOMOTIVE RUBBER PARTS	
MISCELÁNEOS / AUTOMOTIVE RUBBER PARTS					MISCELÁNEOS / AUTOMOTIVE RUBBER PARTS	
			CALZA PARA RESORTE (TIPO NUEVO)	404		
			AUMENTO PARA RESORTE	408	404	408
			GOMA PARA AMORTIGUADOR	505		
			TAPON PARA GATO HID. MEDIANO	800	505	800
			TAPON PARA GATO HID. GRANDE	801		
			SELLO PARA PISTON 11 mm x 7 mm	802	801	802
			SELLO PARA PISTON 12 mm x 7 mm	803		
			SELLO PARA PISTON 13 mm x 7 mm	804	803	804
			SELLO PARA PISTON 16 mm x 7 mm	805		
			SELLO PARA PISTON 17 mm x 7 mm	806	805	808
			SELLO PARA GATO HID. 12 mm X 3 mm	807		
			SELLO PARA PISTON DE GATO HID. 25 mm X 6 mm X 17 mm	808	807	809
			SELLO PARA PISTON DE GATO HID. 25 mm X 6 mm X 14 mm	809		
			SELLO PARA GATO HID. 11 mm X 6 mm	810	810	811
			TAPON PARA GATO HID. CHICO	811		
			CUBRE POLVO PARA ROTULA D.E. 34 mm D.I. 19 mm ALT. 21 mm	850	811	850
				805	806	807
				809	810	811
				850		



CONTINUACIÓN... VARIOS

	 28	APLICACIÓN / DESCRIPTION	DAI PARTS #
MISCELÁNEOS / AUTOMOTIVE RUBBER PARTS			
		CUBRE POLVO PARA ROTULA D.E. 37 mm D.I. 14 mm ALT. 24 mm	851
		CUBRE POLVO PARA ROTULA D.E. 42 mm D.I. 16 mm ALT. 20 mm	852
		CUBRE POLVO PARA ROTULA D.E. 48 mm D.I. 15 mm ALT. 25 mm	853
		CUBRE POLVO PARA ROTULA D.E. 48 mm D.I. 16 mm ALT. 26 mm	854
		CUBRE POLVO PARA ROTULA D.E. 56 mm D.I. 20 mm ALT. 37 mm	855
		CUBRE POLVO PARA ROTULA D.E. 55 mm D.I. 16 mm ALT. 47 mm	856
		CUBRE POLVO PARA ROTULA D.E. 54 mm D.I. 19 mm ALT. 46 mm	857
		CUBRE POLVO PARA ROTULA D.E. 43 mm D.I. 14 mm ALT. 30 mm	858
		CUBRE POLVO PARA ROTULA D.E. 35 mm D.I. 18 mm ALT. 20 mm	859
		CUBRE POLVO PARA ROTULA D.E. 58 mm D.I. 21 mm ALT. 34 mm	860
		ASENTADOR PARA VALVULAS AMERICANO	6001
		ASENTADOR PARA VALVULAS EUROPEOS	6002
		AUMENTO PARA RESORTE (TIPO VAM)	6030
		GOMA TRASERA PARA CASETA	6071

**MISCELÁNEOS
AUTOMOTIVE RUBBER PARTS**

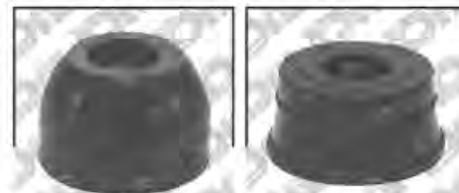

851 852



853 854



855 856



857 858



859

860

6001

6002

6030

6071



VARIOS

28		APLICACIÓN / DESCRIPTION	DAI PARTS #	MISCELÁNEOS AUTOMOTIVE RUBBER PARTS	
MISCELÁNEOS / AUTOMOTIVE RUBBER PARTS					
		GOMA TRASERA PARA CASETA	6072		
		GOMA TRASERA PARA CASETA	6073		
		GOMA TRASERA PARA CASETA	6079		
		CUBRE POLVO PARA PALANCA DE VELOCIDADES (REDONDO)	6086		
		GOMA PARA AMORTIGUADOR (19/32" X 13/16" X 9/16" X 1 5/64" POLIURETANO)	9147		
		GOMA PARA AMORTIGUADOR (19/16" X 3/8" POLIURETANO)	9148		
		GOMA PARA AMORTIGUADOR (1 1/4" X 7/16" POLIURETANO)	9149		
		GOMA PARA TORNILLO ESTABILIZADOR UNIVERSAL (D.I. 9 mm D.E. 29 mm H. 16 mm POLIURETANO)	9167		
		REPUESTO DE GOMAS PARA TORNILLOS 6620, 64630, 64730 Y 64780	64640		
				9149	9148



VAM

AMERICAN

  28		APLICACIÓN / DESCRIPTION	DAI PARTS #
SOPORTES / TRANSMISSION & MOTOR MOUNTS			
L6 3.8 L6 4.2	64-84	SOPORTE PARA MOTOR IZQUIERDO	1710
		SOPORTE PARA MOTOR IZQUIERDO	1711
		SOPORTE PARA MOTOR DERECHO	1777
		SOPORTE PARA TRANSMISIÓN AUT.	1778
		SOPORTE PARA TRANSMISIÓN STD.	1783



MISCELÁNEOS / AUTOMOTIVE RUBBER PARTS			
	64-84	TORNILLO ESTABILIZADOR (6", 177.8 mm)	6101
		TORNILLO ESTABILIZADOR (6", 177.8 mm EQUIPO ORIGINAL)	6105



CLASSIC

MISCELÁNEOS / AUTOMOTIVE RUBBER PARTS			
	67-69	TORNILLO ESTABILIZADOR (5", 1542.400 mm)	6100
		TORNILLO ESTABILIZADOR (5", 1542.400 mm EQUIPO ORIGINAL)	6104



CONCORD

		APLICACIÓN / DESCRIPTION	DAI PARTS #
SOPORTES / TRANSMISSION & MOTOR MOUNTS			
V8 5.0	72-79	SOPORTE PARA MOTOR IZQUIERDO Y DERECHO	6773



GRAND WAGONER

SOPORTES / TRANSMISSION & MOTOR MOUNTS			
V8 5.0	84-91	SOPORTE PARA MOTOR IZQUIERDO Y DERECHO	6773



GREMLIN

SOPORTES / TRANSMISSION & MOTOR MOUNTS			
V8 4.8	72-79	SOPORTE PARA MOTOR IZQUIERDO Y DERECHO	6773



CONTINUACIÓN... GREMLIN

		APLICACIÓN / DESCRIPTION	DAI PARTS #
MISCELÁNEOS / AUTOMOTIVE RUBBER PARTS			
64-84		TORNILLO ESTABILIZADOR (6", 177.8 mm)	6101
		TORNILLO ESTABILIZADOR (6", 177.8 mm EQUIPO ORIGINAL)	6105



J 4WD

SOPORTES / TRANSMISSION & MOTOR MOUNTS			
V8 5.0	75-87	SOPORTE PARA MOTOR IZQUIERDO Y DERECHO	6773



JAVELIN

SOPORTES / TRANSMISSION & MOTOR MOUNTS			
L6 3.8	64-72	SOPORTE PARA MOTOR IZQUIERDO Y DERECHO	1710
		SOPORTE PARA MOTOR IZQUIERDO Y DERECHO	1711
L6 4.2	64-72	SOPORTE PARA MOTOR IZQUIERDO Y DERECHO	1710
		SOPORTE PARA MOTOR IZQUIERDO Y DERECHO	1711
	73-83	SOPORTE PARA MOTOR IZQUIERDO Y DERECHO	1777



CONTINUACIÓN... JAVELIN

 		APLICACIÓN / DESCRIPTION	DAI PARTS #
SOPORTES / TRANSMISSION & MOTOR MOUNTS			
L6 4.2	73-83	SOPORTE PARA TRANSMISIÓN AUT.	1778
		SOPORTE PARA TRANSMISIÓN STD.	1783
	67-69	SOPORTE PARA MOTOR IZQUIERDO Y DERECHO	6773



MISCELÁNEOS / AUTOMOTIVE RUBBER PARTS			
	64-84	TORNILLO ESTABILIZADOR (6", 177.8 mm)	6101
		TORNILLO ESTABILIZADOR (6", 177.8 mm EQUIPO ORIGINAL)	6105

RAMBLER

SOPORTES / TRANSMISSION & MOTOR MOUNTS			
L6 3.8	64-72	SOPORTE PARA MOTOR IZQUIERDO	1710
		SOPORTE PARA MOTOR IZQUIERDO	1711
		SOPORTE PARA MOTOR DERECHO	1777



CONTINUACIÓN... RAMBLER

 		APLICACIÓN / DESCRIPTION	DAI PARTS #
SOPORTES / TRANSMISSION & MOTOR MOUNTS			
L6 4.2	64-72	SOPORTE PARA MOTOR IZQUIERDO	1710
		SOPORTE PARA MOTOR IZQUIERDO	1711
		SOPORTE PARA MOTOR DERECHO	1777
	67-69	SOPORTE PARA MOTOR IZQUIERDO Y DERECHO	6773
	69-73	SOPORTE PARA TRANSMISIÓN	1770
		SOPORTE PARA TRANSMISIÓN	1784
	73-83	SOPORTE PARA TRANSMISIÓN AUT	1778
		SOPORTE PARA TRANSMISIÓN STD	1783



MISCELÁNEOS / AUTOMOTIVE RUBBER PARTS			
	64-83	BUJE PARA BARILLA DE DIRECCIÓN	6059
		BUJE PARA MUELLE (1 19/ 128" X 1 11/16)	9146
	70-82	GOMAS PARA TIRANTE DE SUSPENSIÓN	64580
	71-82	GOMAS PARA TIRANTE DE SUSPENSIÓN	6058

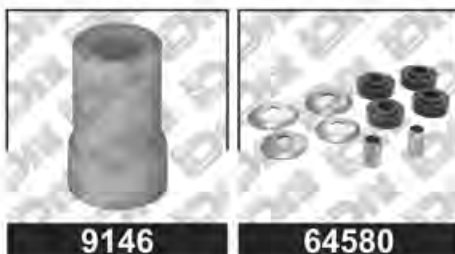

VOLKSWAGEN

ATLANTIC

	28	APLICACIÓN / DESCRIPTION	DAI PARTS #
--	-----------	---------------------------------	--------------------

SOPORTES / TRANSMISSION & MOTOR MOUNTS

	77-87	SOPORTE FILTRO DE AIRE	6162
		SOPORTE O BASE PARA CARBURADOR	1840
		SOPORTE PARA RADIADOR (INTERNO)	6426
		SOPORTE PARA RADIADOR	6617
1600	77-87	REPUESTO PARA SOPORTE DE MOTOR	1833
		REPUESTO PARA SOPORTE DE MOTOR	1867
		SOPORTE PARA TRANSMISIÓN	1832

**SOPORTES
TRANSMISSION & MOTOR MOUNTS**



1832 **1833**



1840 **1867**



6162 **6426** **6617**

28	APLICACIÓN / DESCRIPTION	DAI PARTS #	DAI KIT PARTS #
-----------	---------------------------------	--------------------	------------------------

BASES PARA AMORTIGUADOR / STRUT MOUNTS

77-87	BASE PARA AMORTIGUADOR FRONTAL IZQUIERDA Y DERECHA	1890	1890-KIT
	BASE PARA AMORTIGUADOR TRASERA IZQUIERDA Y DERECHA	6739	6739-KIT
	BALERO PARA BASE DE AMORTIGUADOR (1886, 7055, 7103, 1808, 1852 Y 1890)	6137	

**BASES PARA AMORTIGUADOR
STRUT MOUNTS**



1890 **1890-KIT**



6137 **6739**



6739-KIT



CONTINUACIÓN... ATLANTIC

	 28	APLICACIÓN / DESCRIPTION	DAI PARTS #
CUBRE POLVOS / C.V. BOOTS			
77-87		CUBRE POLVO IZQUIERDO Y DERECHO LADO CAJA	6302
		CUBRE POLVO IZQUIERDO Y DERECHO LADO RUEDA	6305
		CUBRE POLVO IZQUIERDO DE DIRECCIÓN STD.	6300
		CUBRE POLVO DERECHO DE DIRECCIÓN STD.	6301



MISCELÁNEOS / AUTOMOTIVE RUBBER PARTS			
77-87		COPLÉ PARA DIRECCIÓN (SINFÍN DE .690" NO REQUIERE PERNOS)	613
		GALLETAS PARA DIRECCIÓN HID. (NO REQUIERE PERNOS COMPLETO 613 CON BUJES)	627
		BUJE PARA HORQUILLA CHICO	300
		BUJE PARA HORQUILLA GRANDE (PUNTA)	301
		GOMA PARA CREMALLERA DE DIRECCIÓN (IZQUIERDA PAR 709)	708
		GOMA PARA CREMALLERA DE DIRECCIÓN (DERECHA PAR 708)	709
		GOMA SUJETADORA DE ESCAPE	6541



BEETLE

 		APLICACIÓN / DESCRIPTION	DAI PARTS #
SOPORTES / TRANSMISSION & MOTOR MOUNTS			
L4 1.8 L4 2.0	98-12	SOPORTE PARA MOTOR DERECHO	6976-H
		SOPORTE PARA TRANSMISIÓN	6977
		SOPORTE PARA MOTOR TRASERO	6978
L4 2.0	13-15	SOPORTE PARA TRANSMISIÓN	7211
L5 2.5	06-08	SOPORTE PARA TRANSMISIÓN STD. Y AUT.	7212
		SOPORTE PARA MOTOR TRASERO	7254



		APLICACIÓN / DESCRIPTION	DAI PARTS #	DAI KIT PARTS #
BASES PARA AMORTIGUADOR / STRUT MOUNTS				
98-12	BASE PARA AMORTIGUADOR FRONTAL IZQUIERDA Y DERECHA		1815	1815-KIT
	BASE PARA AMORTIGUADOR FRONTAL IZQUIERDA Y DERECHA		1816	
	BASE PARA AMORTIGUADOR FRONTAL IZQUIERDA Y DERECHA		6759	6759-KIT
	BASE PARA AMORTIGUADOR TRASERA IZQUIERDA Y DERECHA		6906	
	BALERO PARA BASE DE AMORTIGUADOR (1815)		6119	



CONTINUACIÓN... BEETLE



	28	APLICACIÓN / DESCRIPTION	DAI PARTS #
CUBRE POLVOS / C.V. BOOTS			
98-12		CUBRE POLVO IZQUIERDO Y DERECHO LADO RUEDA	6384
		CUBRE POLVO IZQUIERDO Y DERECHO LADO CAJA	6312
		CUBRE POLVO IZQUIERDO Y DERECHO DE DIRECCIÓN STD.	6373
		CUBRE POLVO IZQUIERDO Y DERECHO DE DIRECCIÓN HID.	6374



MISCELÁNEOS / AUTOMOTIVE RUBBER PARTS			
98-11		BUJE PARA EJE TRASERO IZQUIERDO Y DERECHO	DAI-1426037
		BUJE PARA HORQUILLA CHICO	DAI-191-407-182
98-13		BUJES PARA HORQUILLA INFERIOR (POLIURETANO KIT CON CASQUILLO)	9809
98-12		TOPE PARA AMORTIGUADOR TRASERO IZQUIERDO Y DERECHO	D-050
		TOPE PARA AMORTIGUADOR Y CUBRE POLVO FRONTAL IZQUIERDO Y DERECHO	DAI-074-KIT
		BUJES PARA HORQUILLA INFERIOR CHICO Y GRANDE (POLIURETANO KIT)	9800
		BUJE PARA HORQUILLA INFERIOR GRANDE (CON CEJA BUJE INTERNO CHICO)	64650
		BUJE PARA HORQUILLA INFERIOR GRANDE (CON CEJA BUJE INTERNO GRANDE)	64651



CONTINUACIÓN... BEETLE

	 28	APLICACIÓN / DESCRIPTION	DAI PARTS #
MISCELÁNEOS / AUTOMOTIVE RUBBER PARTS			
98-12		BUJE PARA HORQUILLA INFERIOR GRANDE (SIN CEJA BUJE INTERO GRANDE)	64760
		GOMA PARA BARRA ESTABILIZADORA IZQUIERDA	64719
		GOMA PARA BARRA ESTABILIZADORA DERECHA	64816
		TORNILLO ESTABILIZADOR FRONTAL DERECHO	DAI-2126002
		BUJE PARA EJE TRASERO	DAI-1J0-501-541
		TORNILLO ESTABILIZADOR FRONTAL	DAI-1J0-411-315-C
99-04		BUJE PARA HORQUILLA CHICO (RSI)	DAI-191-407-182
12-15		BUJE PARA HORQUILLA INFERIOR CHICO	DAI-1426011
		TORNILLO ESTABILIZADOR FRONTAL	DAI-2126010
		BUJE PARA HORQUILLA INFERIOR GRANDE	DAI-1426023



DAI-1426023



DAI-191-407-182



DAI-1J0-411-315-C



DAI-1J0-501-541



DAI-2126002



DAI-2126010



BORA

 28		APLICACIÓN / DESCRIPTION	DAI PARTS #
SOPORTES / TRANSMISSION & MOTOR MOUNTS			
L4 1.9	05-11	SOPORTE PARA MOTOR TRASERO STD. TORQUE STRUT	7776
L4 2.0	05-10	SOPORTE PARA MOTOR TRASERO SUPERIOR (CON CUERDA) (TSI)	7194
		SOPORTE PARA MOTOR TRASERO INFERIOR (SIN CUERDA) (TSI)	7195
	05-11	SOPORTE PARA MOTOR TRASERO STD. TORQUE STRUT	7776
	06-10	SOPORTE PARA TRANSMISIÓN AUT. (TSI)	7211
		SOPORTE PARA TRANSMISIÓN STD. Y AUT. (TSI)	7212
		SOPORTE PARA MOTOR TRASERO (TSI)	7254
L5 2.5	06-10	SOPORTE PARA TRANSMISIÓN AUT.	7211
		SOPORTE PARA TRANSMISIÓN STD. Y AUT.	7212
		SOPORTE PARA MOTOR TRASERO	7254
	05-09	SOPORTE PARA MOTOR TRASERO SUPERIOR (CON CUERDA)	7194
		SOPORTE PARA MOTOR TRASERO INFERIOR (SIN CUERDA)	7195
	05-11	SOPORTE PARA MOTOR DERECHO (DIESEL)	7654-H
		SOPORTE PARA MOTOR TRASERO STD. TORQUE STRUT	7776

**SOPORTES
TRANSMISSION & MOTOR MOUNTS**

7194

7195

7211

7212

7254

7654-H

7776

28	APLICACIÓN / DESCRIPTION	DAI PARTS #	DAI KIT PARTS #
BASES PARA AMORTIGUADOR / STRUT MOUNTS			
06-10	BALERO PARA BASE DE AMORTIGUADOR FRONTAL IZQUIERDO Y DERECHO (7214)	6145	

**BASES PARA AMORTIGUADOR
STRUT MOUNTS**

6145

CONTINUACIÓN... BORA

	 28	APLICACIÓN / DESCRIPTION	DAI PARTS #
CUBRE POLVOS / C.V. BOOTS			
	05-10	CUBRE POLVO IZQUIERDO Y DERECHO LADO CAJA	63110
		CUBRE POLVO IZQUIERDO Y DERECHO LADO RUEDA	63111
		CUBRE POLVO IZQUIERDO Y DERECHO LADO CAJA (TRIPOIDE)	63116
		CUBRE POLVO IZQUIERDO Y DERECHO LADO RUEDA	63118



MISCELÁNEOS / AUTOMOTIVE RUBBER PARTS			
	05-10	TOPE PARA AMORTIGUADOR TRASERO IZQUIERDO Y DERECHO	D-050
		BUJE PARA HORQUILLA INFERIOR CHICO	DAI-1426011
		TORNILLO ESTABILIZADOR FRONTAL	DAI-2126010



BRASILIA

		APLICACIÓN / DESCRIPTION	DAI PARTS #
SOPORTES / TRANSMISSION & MOTOR MOUNTS			
4 Hop 1500 1600 1600 I	53-00	SOPORTE PARA MOTOR IZQUIERDO Y DERECHO	1715
4 Hop 1500	53-73	SOPORTE PARA TRANSMISIÓN	1924
4 Hop 1600 1600 I	74-00	SOPORTE PARA TRANSMISIÓN	1805

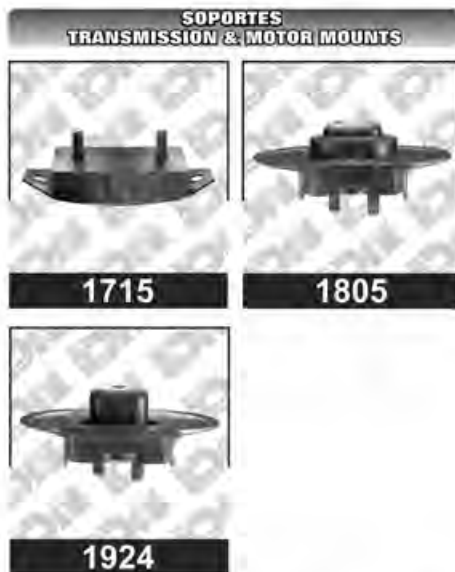

MISCELÁNEOS / AUTOMOTIVE RUBBER PARTS			
	53-00	COPLÉ PARA DIRECCIÓN (SINFÍN DE .637" NO REQUIERE PERNOS)	609
		GALLETAS PARA DIRECCIÓN STD. Y HID. (NO REQUIERE PERNOS COMPLETO 609)	623

CABRIOLET

		APLICACIÓN / DESCRIPTION	DAI PARTS #	DAI KIT PARTS #
BASES PARA AMORTIGUADOR / STRUT MOUNTS				
85-93		BASE PARA AMORTIGUADOR FRONTAL IZQUIERDA Y DERECHA	1890	1890-KIT
		BALERO PARA BASE DE AMORTIGUADOR 1886, 1886, 7055, 7103, 1808, 1852 Y 1890	6137	



CARIBE

	 28	APLICACIÓN / DESCRIPTION	DAI PARTS #
---	--	--------------------------	-------------

SOPORTES / TRANSMISSION & MOTOR MOUNTS

	77-87	SOPORTE O BASE PARA CARBURADOR	1840
		SOPORTE PARA FILTRO DE AIRE	6162
		SOPORTE PARA RADIADOR	6617
L4 1600 1700	78-87	SOPORTE PARA TRANSMISIÓN	1832
		REPUESTO PARA SOPORTE DE MOTOR	1833
		REPUESTO PARA SOPORTE DE MOTOR	1867
		GOMA LIMITADORA FRONTAL	6426

**SOPORTES
TRANSMISSION & MOTOR MOUNTS**



1832

1833

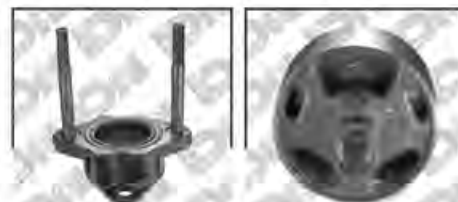

1840

1867



6162

6426

6617

 28	APLICACIÓN / DESCRIPTION	DAI PARTS #	DAI KIT PARTS #
--	--------------------------	-------------	-----------------

BASES PARA AMORTIGUADOR / STRUT MOUNTS

77-87	BASE PARA AMORTIGUADOR FRONTAL IZQUIERDA Y DERECHA	1890	1890-KIT
	BALERO PARA BASE DE AMORTIGUADOR (1886, 7055, 7103, 1808, 1852 Y 1890)	6137	
	BASE PARA AMORTIGUADOR TRASERA IZQUIERDA Y DERECHA	6739	6739-KIT

**BASES PARA AMORTIGUADOR
STRUT MOUNTS**



1890

1890-KIT



6137

6739

6739-KIT



CONTINUACIÓN... CARIBE

28		APLICACIÓN / DESCRIPTION	DAI PARTS #	DAI KIT PARTS #
CUBRE POLVOS / C.V. BOOTS				
77-87		CUBRE POLVO IZQUIERDO DE DIRECCIÓN STD.		6300
		CUBRE POLVO DERECHO DE DIRECCIÓN STD.		6301
		CUBRE POLVO IZQUIERDO Y DERECHO LADO CAJA		6302
		CUBRE POLVO IZQUIERDO Y DERECHO LADO RUEDA		6305



MISCELÁNEOS / AUTOMOTIVE RUBBER PARTS			
77-87		BUJE PARA HORQUILLA CHICO	300
		BUJE PARA HORQUILLA GRANDE (PUNTA)	301
		GOMA PARA CREMALLERA DE DIRECCIÓN (IZQUIERDA PAR 709)	708
		GOMA PARA CREMALLERA DE DIRECCIÓN (DERECHA PAR 708)	709
		GOMA SUJETADORA DE ESCAPE	6541



COMBI

		APLICACIÓN / DESCRIPTION	DAI PARTS #
SOPORTES / TRANSMISSION & MOTOR MOUNTS			
	65-00	SOPORTE CONVERTIDOR CATALITICO	1882
4 HOP 1500 1600	65-88	SOPORTE MOTOR IZQUIERDO Y DERECHO	1835
		SOPORTE TRANSMISIÓN	6611
4 HOP 1800	89-00	SOPORTE PARA MOTOR IZQUIERDO Y DERECHO	1900
		SOPORTE PARA TRANSMISIÓN	1942
		REPUESTO PARA SOPORTE DE TRANSMISIÓN (1942)	1942-9

**SOPORTES
TRANSMISSION & MOTOR MOUNTS**



1835



1882



1900



1942



1942-9



6611

CUBRE POLVOS / C.V. BOOTS

	65-03	CUBRE POLVO IZQUIERDO Y DERECHO LADO CAJA	6303
--	-------	---	------

**CUBRE POLVOS
C.V. BOOTS**



6303

MISCELÁNEOS / AUTOMOTIVE RUBBER PARTS

	65-00	GOMA PARA SUSPENSIÓN IZQUIERDO Y DERECHA	FP05
		GOMA PARA AMORTIGUADOR	77

**MISCELÁNEOS
AUTOMOTIVE RUBBER PARTS**



FP05



77



CONTINUACIÓN... COMBI

		APLICACIÓN / DESCRIPTION	DAI PARTS #	MISCELÁNEOS / AUTOMOTIVE RUBBER PARTS	
65-00		TOPE PARA SUSPENSIÓN TRASERO IZQUIERDO Y DERECHO	332		
		GOMA PARA PEDAL DE ACCELERADOR	370		
		COPE PARA DIRECCIÓN (SINFÍN DE .750" NO REQUIERE PERNOS)	612		
		GALLETAS PARA DIRECCIÓN STD. (NO REQUIERE PERNOS COMPLETO 612)	624		
		GOMA PARA BARRA ESTABILIZADORA	6042		
		TOPE PARA SUSPENSIÓN DELANTERA SUPERIOR (DAIM. 60 mm ALT. 40 mm)	6126		
		TOPE PARA SUSPENSIÓN DELANTERA INFERIOR (DIAM. 60 mm ALT. 65 mm)	6127		

CORRADO

		APLICACIÓN / DESCRIPTION	DAI PARTS #	DAI KIT PARTS #	BASES PARA AMORTIGUADOR / STRUT MOUNTS	
90-94		BASE PARA AMORTIGUADOR FRONTAL IZQUIERDA Y DERECHA	1886	1886-KIT		
		BALERO PARA BASE DE AMORTIGUADOR (1886, 1886, 7055, 7103, 1808, 1852 Y 1890)	6137			



CORSAR

  28		APLICACIÓN / DESCRIPTION	DAI PARTS #
SOPORTES / TRANSMISSION & MOTOR MOUNTS			
L4 1.8	84-91	SOPORTE PARA MOTOR IZQUIERDO Y DERECHO	1900
		SOPORTE PARA TRANSMISIÓN	6679



 28		APLICACIÓN / DESCRIPTION	DAI PARTS #	DAI KIT PARTS #
BASES PARA AMORTIGUADOR / STRUT MOUNTS				
84-89	BASE PARA AMORTIGUADOR FRONTAL IZQUIERDA Y DERECHA	6687	6687-KIT	
	BASE PARA AMORTIGUADOR TRASERA IZQUIERDA Y DERECHA	6739	6739-KIT	
	BASE PARA AMORTIGUADOR FRONTAL IZQUIERDA Y DERECHA	6757		



CUBRE POLVOS / C.V. BOOTS			
	84-91	CUBRE POLVO IZQUIERDO Y DERECHO LADO CAJA	6302
		CUBRE POLVO IZQUIERDO Y DERECHO LADO RUEDA	6305



CONTINUACIÓN... CORSAR

 28		APLICACIÓN / DESCRIPTION	DAI PARTS #
MISCELÁNEOS / AUTOMOTIVE RUBBER PARTS			
84-91		COPLÉ PARA DIRECCIÓN (SINFÍN DE .690" NO REQUIERE PERNOS)	613
		GALLETAS PARA DIRECCIÓN HID. (CON BUJES) (NO REQUIERE PERNOS COMPLETO 613)	627
		BUJE PARA HORQUILLA INFERIOR	64720



CROSS FOX

SOPORTES / TRANSMISSION & MOTOR MOUNTS			
L4 1.6	07-12	SOPORTE PARA MOTOR DERECHO	7057-H
		SOPORTE PARA MOTOR TRASERO	7058
		SOPORTE PARA TRANSMISIÓN	7060



CONTINUACIÓN... CROSS FOX

28	APLICACIÓN / DESCRIPTION	DAI PARTS #	DAI KIT PARTS #
BASES PARA AMORTIGUADOR / STRUT MOUNTS			
07-12	BALERO PARA BASE DE AMORTIGUADOR FRONTAL IZQUIERDO Y DERECHO (7214)	6145	
	BASE PARA AMORTIGUADOR TRASERA IZQUIERDA Y DERECHA	6906	
	BASE PARA AMORTIGUADOR FRONTAL IZQUIERDA Y DERECHA	7214	7214-KIT



28	APLICACIÓN / DESCRIPTION	DAI PARTS #
CUBRE POLVOS / C.V. BOOTS		
07-15	CUBRE POLVO IZQUIERDO Y DERECHO LADO RUEDA	63147
	CUBRE POLVO IZQUIERDO Y DERECHO LADO CAJA	63148
	CUBRE POLVO IZQUIERDO Y DERECHO DE DIRECCIÓN	63149



MISCELÁNEOS / AUTOMOTIVE RUBBER PARTS		
07-15	BUJE PARA EJE TRASERO IZQUIERDO Y DERECHO	DAI-1426037
	TORNILLO ESTABILIZADOR FRONTAL	DAI-2126004



CONTINUACIÓN... CROSS FOX

 		APLICACIÓN / DESCRIPTION	DAI PARTS #
MISCELÁNEOS / AUTOMOTIVE RUBBER PARTS			
07-15		BUJE PARA EJE TRASERO	DAI-1J0-501-541
07-12		BUJE INFERIOR GRANDE	64812
		BUJE PARA HORQUILLA INFERIOR CHICO	DAI-1426003

**MISCELÁNEOS
AUTOMOTIVE RUBBER PARTS**

64812

DAI-1426003

DAI-1J0-501-541
DASHER



 		APLICACIÓN / DESCRIPTION	DAI PARTS #	DAI KIT PARTS #
BASES PARA AMORTIGUADOR / STRUT MOUNTS				
74-81		BASE PARA AMORTIGUADOR FRONTAL IZQUIERDA Y DERECHA	1890	1890-KIT
		BALERO PARA BASE DE AMORTIGUADOR 1886, 7055, 7103, 1808, 1852 Y 1890	6137	

**BASES PARA AMORTIGUADOR
STRUT MOUNTS**

1890

1890-KIT

6137
DERBY

 		APLICACIÓN / DESCRIPTION	DAI PARTS #
SOPORTES / TRANSMISSION & MOTOR MOUNTS			
L4 1.8	95-09	SOPORTE PARA MOTOR FRONTAL	6661
		SOPORTE PARA MOTOR TRASERO	6662

**SOPORTES
TRANSMISSION & MOTOR MOUNTS**

6661

6662

CONTINUACIÓN... DERBY



 		APLICACIÓN / DESCRIPTION	DAI PARTS #
SOPORTES / TRANSMISSION & MOTOR MOUNTS			
L4 1.8	95-09	SOPORTE PARA TRANSMISIÓN STD.	6663
		SOPORTE PARA TRANSMISIÓN STD.	6663-S
		SOPORTE PARA MOTOR FRONTAL	6692
		SOPORTE PARA TRANSMISIÓN AUT.	6693
		SOPORTE PARA MOTOR TRASERO (CON BASE)	6842



	APLICACIÓN / DESCRIPTION	DAI PARTS #	DAI KIT PARTS #
BASES PARA AMORTIGUADOR / STRUT MOUNTS			
95-09	BASE PARA AMORTIGUADOR TRASERA IZQUIERDA Y DERECHA	7301	
	BASE PARA AMORTIGUADOR TRASERA IZQUIERDA Y DERECHA	6739	6739-KIT
	BASE PARA AMORTIGUADOR FRONTAL IZQUIERDA Y DERECHA	1886	1886-KIT
	BALERO PARA BASE DE AMORTIGUADOR 1886, 7055, 7103, 1808, 1852 Y 1890	6137	



CONTINUACIÓN... DERBY



	 28	APLICACIÓN / DESCRIPTION	DAI PARTS #
CUBRE POLVOS / C.V. BOOTS			
	95-09	CUBRE POLVO IZQUIERDO Y DERECHO LADO CAJA	6383
		CUBRE POLVO IZQUIERDO Y DERECHO LADO RUEDA	6384
		CUBRE POLVO IZQUIERDO Y DERECHO LADO RUEDA	6384



MISCELÁNEOS / AUTOMOTIVE RUBBER PARTS			
	95-09	TOPE PARA AMORTIGUADOR TRASERO IZQUIERDO Y DERECHO	D-050
		TOPE PARA AMORTIGUADOR FRONTAL IZQUIERDO Y DERECHO	D-074
		BUJE PARA BARRA TRASERA BUJE EXTERIOR	64740
		BUJE PARA HORQUILLA CHICO	DAI-191-407-182
		TORNILLO ESTABILIZADOR FRONTAL IZQUIERDO Y DERECHO	DAI-2126005



EUROVAN

 		APLICACIÓN / DESCRIPTION	DAI PARTS #
SOPORTES / TRANSMISSION & MOTOR MOUNTS			
L4 1.9	05-10	SOPORTE PARA MOTOR FRONTAL (TDI)	7139
		SOPORTE PARA TRANSMISIÓN (TDI)	7143
		SOPORTE PARA MOTOR TRASERO (TDI)	7145
		SOPORTE PARA MOTOR DERECHO (TDI)	7467-H
L4 2.0	00-06	SOPORTE PARA MOTOR IZQUIERDO	7446
L5 2.5	92-96	SOPORTE PARA MOTOR DERECHO (T4)	6988-H
		SOPORTE PARA MOTOR TRASERO AUT. (T4)	7056
		SOPORTE PARA MOTOR TRASERO STD. (T4)	7061
		SOPORTE PARA MOTOR DERECHO (T4)	7062
	00-04	SOPORTE PARA MOTOR TRASERO (PENDULAR)	7059
		REPUESTO PARA SOPORTE DE MOTOR TRASERO (PENDULAR) (7059)	7059-9
		SOPORTE PARA MOTOR DERECHO	7093-H
		SOPORTE PARA MOTOR TRASERO	7098-H
V6 2.8	00-09	SOPORTE PARA MOTOR DERECHO (VR6)	7093-H
		SOPORTE PARA MOTOR DERECHO (VR6)	7092-H

**SOPORTES
TRANSMISSION & MOTOR MOUNTS**



6988-H

7056



7059

7059-9

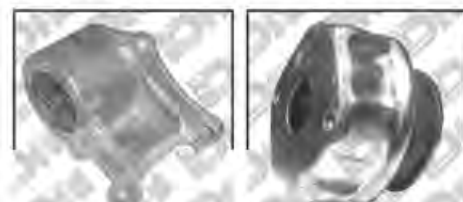

7061

7062



7092-H

7093-H



7098-H

7139

7143

7145



7446

7467-H



CONTINUACIÓN... EUROVAN

	28	APLICACIÓN / DESCRIPTION	DAI PARTS #
CUBRE POLVOS / C.V. BOOTS			
	00-04	CUBRE POLVO IZQUIERDO Y DERECHO LADO RUEDA	6337
	00-09	CUBRE POLVO IZQUIERDO Y DERECHO LADO RUEDA (VR6)	
	05-10	CUBRE POLVO IZQUIERDO Y DERECHO LADO RUEDA (TDI)	
	00-04	CUBRE POLVO IZQUIERDO Y DERECHO LADO CAJA	6349
	00-09	CUBRE POLVO IZQUIERDO Y DERECHO LADO CAJA (VR6)	
	05-10	CUBRE POLVO IZQUIERDO Y DERECHO LADO CAJA (TDI)	
	00-04	CUBRE POLVO IZQUIERDO DE DIRECCIÓN STD.	6352
	00-09	CUBRE POLVO IZQUIERDO DE DIRECCIÓN STD. (VR6)	
	05-10	CUBRE POLVO IZQUIERDO DE DIRECCIÓN STD. (TDI)	
	00-04	CUBRE POLVO IZQUIERDO Y DERECHO LADO CAJA	63117
	00-09	CUBRE POLVO IZQUIERDO Y DERECHO LADO CAJA (VR6)	
	05-10	CUBRE POLVO IZQUIERDO Y DERECHO LADO CAJA (TDI)	
	00-04	CUBRE POLVO IZQUIERDO Y DERECHO LADO RUEDA	63118
	00-09	CUBRE POLVO IZQUIERDO Y DERECHO LADO RUEDA (VR6)	
	05-10	CUBRE POLVO IZQUIERDO Y DERECHO LADO RUEDA (TDI)	

**CUBRE POLVOS
C.V. BOOTS**

6337

6349

6352

63117

63118

MISCELÁNEOS / AUTOMOTIVE RUBBER PARTS			
	05-09	BUJE PARA CHASIS Ó BASTIDOR	7449
	00-04	GOMA PARA BARRA ESTABILIZADORA REDONDA	64694
	00-09	GOMA PARA BARRA ESTABILIZADORA REDONDA (VR6)	
	05-10	GOMA PARA BARRA ESTABILIZADORA REDONDA (TDI)	

**MISCELÁNEOS
AUTOMOTIVE RUBBER PARTS**

7449

64694

CONTINUACIÓN... EUROVAN

	 28	APLICACIÓN / DESCRIPTION	DAI PARTS #
MISCELÁNEOS / AUTOMOTIVE RUBBER PARTS			
	00-04	GOMA PARA BARRA ESTABILIZADORA	64739
	00-09	GOMA PARA BARRA ESTABILIZADORA (VR6)	
	05-10	GOMA PARA BARRA ESTABILIZADORA (TDI)	
		BUJE PARA HORQUILLA	64820
	01-04	BUJE SUPERIOR GRANDE	DAI-1426005
		BUJE SUPERIOR CHICO	DAI-1426006
	05-13	TORNILLO ESTABILIZADOR FRONTAL (TDI)	DAI-2126013

**MISCELÁNEOS
AUTOMOTIVE RUBBER PARTS**



64739



64820



DAI-1426005



DAI-1426006



GOL

SOPORTES / TRANSMISSION & MOTOR MOUNTS			
L4 1.8	09-17	SOPORTE PARA MOTOR TRASERO	7058
		SOPORTE PARA MOTOR DERECHO	7393
		SOPORTE PARA TRANSMISIÓN	7380

**SOPORTES
TRANSMISSION & MOTOR MOUNTS**



7058



7393



CONTINUACIÓN... GOL

28	APLICACIÓN / DESCRIPTION	DAI PARTS #	DAI KIT PARTS #
BASES PARA AMORTIGUADOR / STRUT MOUNTS			
09-17	BASE PARA AMORTIGUADOR FRONTAL IZQUIERDA Y DERECHA	1815	1815-KIT
	BALERO PARA BASE DE AMORTIGUADOR (1815)	6119	

6119



28	APLICACIÓN / DESCRIPTION	DAI PARTS #
CUBRE POLVOS / C.V. BOOTS		
09-17	CUBRE POLVO IZQUIERDO Y DERECHO LADO RUEDA	63147
	CUBRE POLVO IZQUIERDO Y DERECHO LADO CAJA	63148
	CUBRE POLVO IZQUIERDO Y DERECHO DE DIRECCIÓN	63149



MISCELÁNEOS / AUTOMOTIVE RUBBER PARTS		
09-17	TOPE PARA AMORTIGUADOR FRONTAL IZQUIERDO Y DERECHO	D-015



CONTINUACIÓN... GOL

	 31	APLICACIÓN / DESCRIPTION	DAI PARTS #
MISCELÁNEOS / AUTOMOTIVE RUBBER PARTS			
09-17		TORNILLO ESTABILIZADOR FRONTAL	DAI-2126004
		TOPE PARA AMORTIGUADOR TRASERO IZQUIERDO Y DERECHO	D-050
		BUJES PARA HORQUILLA INFERIOR CHICO Y GRANDE (POLIURETANO KIT)	9800
		BUJE PARA HORQUILLA INFERIOR GRANDE (CON CEJA BUJE INTERNO CHICO)	64650
		BUJE PARA HORQUILLA INFERIOR GRANDE (CON CEJA BUJE INTERNO GRANDE)	64651
		BUJE PARA HORQUILLA INFERIOR GRANDE (SIN CEJA BUJE INTERNO GRANDE)	64760
		BUJE PARA HORQUILLA CHICO	DAI-191-407-182
		TOPE PARA AMORTIGUADOR Y CUBRE POLVO FRONTAL IZQUIERDO Y DERECHO	DAI-015-KIT
		TOPE PARA AMORTIGUADOR Y CUBRE POLVO TRASERO IZQUIERDO Y DERECHO	DAI-071-KIT
	BUJE PARA HORQUILLA POLIURETANO KIT CON CASQUILLO	9809	

**MISCELÁNEOS
AUTOMOTIVE RUBBER PARTS**



9800



9809



64650



64651



64760



D-050



DAI-015-KIT



DAI-071-KIT



DAI-2126004



DAI-191-407-182



GOLF

 		APLICACIÓN / DESCRIPTION	DAI PARTS #
SOPORTES / TRANSMISSION & MOTOR MOUNTS			
L4 1.9	06-12	SOPORTE PARA TRANSMISIÓN STD. Y AUT. (TDI)	7212
		SOPORTE PARA MOTOR TRASERO TORQUE STRUT (TDI)	7254
L4 2.0	06-12	SOPORTE PARA TRANSMISIÓN STD. Y AUT. (TDI)	7212
		SOPORTE PARA MOTOR TRASERO TORQUE STRUT (TDI)	7254
L5 2.5	06-12	SOPORTE PARA TRANSMISIÓN STD. Y AUT. (TDI)	7212
		SOPORTE PARA MOTOR TRASERO TORQUE STRUT (TDI)	7254

**SOPORTES
TRANSMISSION & MOTOR MOUNTS**

7212

7254

		APLICACIÓN / DESCRIPTION	DAI PARTS #	DAI KIT PARTS #
BASES PARA AMORTIGUADOR / STRUT MOUNTS				
83-06		BASE PARA AMORTIGUADOR FRONTAL IZQUIERDA Y DERECHA	1815	1815-KIT
		BASE PARA AMORTIGUADOR FRONTAL IZQUIERDA Y DERECHA	1852	1852-KIT
		BASE PARA AMORTIGUADOR FRONTAL IZQUIERDA Y DERECHA	1890	1890-KIT
		BALERO PARA BASE DE AMORTIGUADOR 1815	6119	
		BALERO PARA BASE DE AMORTIGUADOR 1808, 1852, 1886, 1890, 7055 Y 7103	6137	

**BASES PARA AMORTIGUADOR
STRUT MOUNTS**

1815

1815-KIT

1852

1852-KIT

1890

1890-KIT

6119

6137

CONTINUACIÓN... GOLF

		APLICACIÓN / DESCRIPTION	DAI PARTS #
MISCELÁNEOS / AUTOMOTIVE RUBBER PARTS			
	83-87	SOPORTE FILTRO DE AIRE	6162
	99-04	BUJE PARA HORQUILLA CHICO (VR6)	DAI-191-407-182

**MISCELÁNEOS
AUTOMOTIVE RUBBER PARTS**



6162



DAI-191-407-182

GOLF A2

SOPORTES / TRANSMISSION & MOTOR MOUNTS			
L4 1.8 L4 2.0	87-92	SOPORTE PARA MOTOR DERECHO	6659
		REPUESTO SOPORTE DE MOTOR FRONTAL (1ra VERSIÓN)	1982
		SOPORTE PARA MOTOR FRONTAL STD.	6658
		SOPORTE PARA MOTOR FRONTAL (CON BASE)	6841
		SOPORTE PARA MOTOR FRONTAL AUT.	6692
		SOPORTE PARA TRANSMISIÓN STD.	6660
		SOPORTE PARA TRANSMISIÓN AUT.	6693
87-92	SOPORTE O BASE PARA CARBURADOR	1861	
	SOPORTE PARA RADIADOR	6161	

**SOPORTES
TRANSMISSION & MOTOR MOUNTS**



1861



1982



6161



6658



6692



6693



6841



6659



6660



CONTINUACIÓN... GOLF A2



28		APLICACIÓN / DESCRIPTION	DAI PARTS #	DAI KIT PARTS #
BASES PARA AMORTIGUADOR / STRUT MOUNTS				
87-92		REPUESTO BASE DE AMORTIGUADOR TRASERA IZQUIERDA Y DERECHA	75	
		REPUESTO BASE DE AMORTIGUADOR TRASERA IZQUIERDA Y DERECHA	76	
		BASE PARA AMORTIGUADOR FRONTAL IZQUIERDA Y DERECHA	1860	
		BASE PARA AMORTIGUADOR FRONTAL IZQUIERDA Y DERECHA	1886	1886-KIT
		BASE PARA AMORTIGUADOR TRASERA IZQUIERDA Y DERECHA	7301	
		BALERO PARA BASE DE AMORTIGUADOR 1808, 1852, 1886, 1890, 7055 Y 7103	6137	
		BASE PARA AMORTIGUADOR TRASERA IZQUIERDA Y DERECHA	6739	6739-KIT



28		APLICACIÓN / DESCRIPTION	DAI PARTS #
CUBRE POLVOS / C.V. BOOTS			
87-92		CUBRE POLVO IZQUIERDO Y DERECHO LADO CAJA	6302
		CUBRE POLVO IZQUIERDO Y DERECHO LADO RUEDA	6305
		CUBRE POLVO IZQUIERDO Y DERECHO DE DIRECCIÓN STD.	6373
		CUBRE POLVO IZQUIERDO Y DERECHO DE DIRECCIÓN HID.	6374



CONTINUACIÓN... GOLF A2

 		APLICACIÓN / DESCRIPTION	DAI PARTS #
MISCELÁNEOS / AUTOMOTIVE RUBBER PARTS			
87-92		GOMA PARA AMORTIGUADOR	78
		TOPE PARA AMORTIGUADOR FRONTAL IZQUIERDO Y DERECHO (HULE)	331
		AUMENTO PARA RESORTE Alt. 29.5 mm	409
		TOPE PARA AMORTIGUADOR TRASERO IZQUIERDO Y DERECHO (HULE)	2005
		GOMA PARA CREMALLERA DE DIRECCIÓN	6070
		TORNILLO ESTABILIZADOR FRONTAL IZQUIERDO Y DERECHO	6097
		GOMA SUJETADORA DE ESCAPE	6563
		GOMA PARA BARRA ESTABILIZADORA	64729
		BUJE PARA BARRA TRASERA EXTERIOR	64740
		TOPE PARA AMORTIGUADOR TRASERO IZQUIERDO Y DERECHO	D-050
		TOPE PARA AMORTIGUADOR Y CUBRE POLVO FRONTAL IZQUIERDO Y DERECHO	DAI-074-KIT
		BUJE PARA HORQUILLA CHICO	DAI-191-407-182

**MISCELÁNEOS
AUTOMOTIVE RUBBER PARTS**



78



331



409



2005



6070



6097



6563



64729



64740



D-050



DAI-074-KIT



DAI-191-407-182

GOLF A3

SOPORTES / TRANSMISSION & MOTOR MOUNTS			
L4 1.6 L4 2.0	93-99	SOPORTE PARA TRANSMISIÓN STD.	6663-S

**SOPORTES
TRANSMISSION & MOTOR MOUNTS**



6663-S



CONTINUACIÓN... GOLF A3

 28		APLICACIÓN / DESCRIPTION	DAI PARTS #
SOPORTES / TRANSMISSION & MOTOR MOUNTS			
L4 1.8 L4 2.0	93-99	SOPORTE PARA MOTOR FRONTAL	6661
		SOPORTE PARA MOTOR TRASERO	6662
		SOPORTE PARA TRANSMISIÓN STD.	6663
		SOPORTE PARA TRANSMISIÓN AUT.	6693
		SOPORTE PARA MOTOR TRASERO (CON BASE)	6842
	93-99	SOPORTE O BASE PARA CARBURADOR	6823



 28		APLICACIÓN / DESCRIPTION	DAI PARTS #	DAI KIT PARTS #
BASES PARA AMORTIGUADOR / STRUT MOUNTS				
93-99		REPUESTO BASE DE AMORTIGUADOR TRASERA IZQUIERDA Y DERECHA	75	
		REPUESTO BASE DE AMORTIGUADOR TRASERA IZQUIERDA Y DERECHA	76	
		BASE PARA AMORTIGUADOR FRONTAL IZQUIERDA Y DERECHA	1886	1886-KIT



CONTINUACIÓN... GOLF A3

28	APLICACIÓN / DESCRIPTION	DAI PARTS #	DAI KIT PARTS #
BASES PARA AMORTIGUADOR / STRUT MOUNTS			
93-99	BASE PARA AMORTIGUADOR TRASERA IZQUIERDA Y DERECHA	6739	6739-KIT
	BASE PARA AMORTIGUADOR TRASERA IZQUIERDA Y DERECHA	7301	
	BALERO PARA BASE DE AMORTIGUADOR 1808, 1852, 1886, 1890, 7055 Y 7103	6137	



CUBRE POLVOS / C.V. BOOTS

93-99	CUBRE POLVO IZQUIERDO Y DERECHO DE DIRECCIÓN STD.	6373
	CUBRE POLVO IZQUIERDO Y DERECHO DE DIRECCIÓN HID.	6374
	CUBRE POLVO IZQUIERDO LADO CAJA	6382
	CUBRE POLVO DERECHO LADO CAJA	6383
	CUBRE POLVO IZQUIERDO Y DERECHO LADO RUEDA	6384



CONTINUACIÓN... GOLF A3

		APLICACIÓN / DESCRIPTION	DAI PARTS #
MISCELÁNEOS / AUTOMOTIVE RUBBER PARTS			
93-99		TOPE PARA AMORTIGUADOR TRASERO IZQUIERDO Y DERECHO	D-050
		TOPE PARA AMORTIGUADOR FRONTAL IZQUIERDO Y DERECHO	D-074
		TOPE PARA AMORTIGUADOR FRONTAL IZQUIERDO Y DERECHO (HULE)	331
		TOPE PARA AMORTIGUADOR TRASERO IZQUIERDO Y DERECHO (HULE)	2005
		GOMA SUJETADORA DE ESCAPE	6564
		GOMA SUJETADORA DE ESCAPE	6699
		BUJE PARA BARRA TRASERA EXTERIOR	64750
		BUJE PARA HORQUILLA CHICO	DAI-191-407-182
	TORNILLO ESTABILIZADOR FRONTAL	DAI-1H0-411-315	

GOLF A4

SOPORTES / TRANSMISSION & MOTOR MOUNTS			
L4 1.8 L4 2.0	98-13	SOPORTE PARA MOTOR DERECHO	6976-H
		SOPORTE PARA TRANSMISIÓN	6977
		SOPORTE PARA MOTOR TRASERO	6978



CONTINUACIÓN... GOLF A4



	APLICACIÓN / DESCRIPTION	DAI PARTS #	DAI KIT PARTS #
BASES PARA AMORTIGUADOR / STRUT MOUNTS			
98-09	BASE PARA AMORTIGUADOR FRONTAL IZQUIERDA Y DERECHA	1815	1815-KIT
	BASE PARA AMORTIGUADOR FRONTAL IZQUIERDA Y DERECHA	6759	6759-KIT
	BASE PARA AMORTIGUADOR TRASERA IZQUIERDA Y DERECHA	6906	
	BASE PARA AMORTIGUADOR FRONTAL IZQUIERDA Y DERECHA	1816	
	BALERO PARA BASE DE AMORTIGUADOR 1815	6119	
98-13	REPUESTO BASE DE AMORTIGUADOR TRASERA IZQUIERDA Y DERECHA	75	
	REPUESTO BASE DE AMORTIGUADOR TRASERA IZQUIERDA Y DERECHA	76	



	APLICACIÓN / DESCRIPTION	DAI PARTS #
CUBRE POLVOS / C.V. BOOTS		
98-09	CUBRE POLVO IZQUIERDO Y DERECHO LADO RUEDA	6384
	CUBRE POLVO IZQUIERDO Y DERECHO LADO CAJA	6312
98-07	CUBRE POLVO IZQUIERDO Y DERECHO LADO CAJA	6314
	CUBRE POLVO IZQUIERDO Y DERECHO DE DIRECCIÓN STD.	6345



CONTINUACIÓN... GOLF A4

	 31	APLICACIÓN / DESCRIPTION	DAI PARTS #
CUBRE POLVOS / C.V. BOOTS			
98-13		CUBRE POLVO IZQUIERDO Y DERECHO DE DIRECCIÓN STD.	6373
		CUBRE POLVO IZQUIERDO Y DERECHO DE DIRECCIÓN HID.	6374



MISCELÁNEOS / AUTOMOTIVE RUBBER PARTS			
98-09		BUJES PARA HORQUILLA INFERIOR CHICO Y GRANDE (POLIURETANO KIT)	9800
		BUJES PARA HORQUILLA INFERIOR (POLIURETANO KIT CON CASQUILLO)	9809
		BUJE PARA HORQUILLA INFERIOR GRANDE (CON CEJA BUJE INTERNO CHICO)	64650
		BUJE PARA HORQUILLA INFERIOR GRANDE (CON CEJA BUJE INTERNO GRANDE)	64651
		BUJE PARA HORQUILLA INFERIOR GRANDE (SIN CEJA BUJE INTERNO GRANDE)	64760
		GOMA PARA BARRA ESTABILIZADORA IZQUIERDA	64719
		GOMA PARA CAJA DE DIRECCIÓN	64815
		GOMA PARA BARRA ESTABILIZADORA DERECHA	64816
		TORNILLO ESTABILIZADOR FRONTAL DERECHO	DAI-2126002
98-07		BUJE PARA HORQUILLA CHICO	DAI-191-407-182
		BUJE PARA EJE TRASERO	DAI-1J0-501-541



CONTINUACIÓN... GOLF A4



		APLICACIÓN / DESCRIPTION	DAI PARTS #
MISCELÁNEOS / AUTOMOTIVE RUBBER PARTS			
	98-11	TORNILLO ESTABILIZADOR FRONTAL	DAI-1J0-411-315-C
	98-13	TOPE PARA AMORTIGUADOR FRONTAL IZQUIERDO Y DERECHO	D-074
		TOPE PARA AMORTIGUADOR Y CUBRE POLVO FRONTAL IZQUIERDO Y DERECHO	DAI-074-KIT
	98-15	BUJE PARA EJE TRASERO IZQUIERDO Y DERECHO	DAI-1426037



GOLF A5

		APLICACIÓN / DESCRIPTION	DAI PARTS #	DAI KIT PARTS #
BASES PARA AMORTIGUADOR / STRUT MOUNTS				
	06-10	BALERO PARA BASE DE AMORTIGUADOR FRONTAL IZQUIERDO Y DERECHO (7214)	6145	



		APLICACIÓN / DESCRIPTION	DAI PARTS #
MISCELÁNEOS / AUTOMOTIVE RUBBER PARTS			
	06-10	BUJE PARA HORQUILLA INFERIOR CHICO	DAI-1426011
		TORNILLO ESTABILIZADOR FRONTAL	DAI-2126010



GOLF A6

31	APLICACIÓN / DESCRIPTION	DAI PARTS #	DAI KIT PARTS #
BASES PARA AMORTIGUADOR / STRUT MOUNTS			
10-12	BALERO PARA BASE DE AMORTIGUADOR FRONTAL IZQUIERDO Y DERECHO (7214)	6145	

GOLF GTI

SOPORTES / TRANSMISSION & MOTOR MOUNTS			
L4 2.0	06-10	SOPORTE PARA TRANSMISIÓN AUT.	7211
		SOPORTE PARA MOTOR TRASERO TORQUE STRUT	7254
	06-11	SOPORTE PARA MOTOR DERECHO	7654-H
	06-12	SOPORTE PARA MOTOR TRASERO SUPERIOR (CON CUERDA)	7194
		SOPORTE PARA MOTOR TRASERO INFERIOR (SIN CUERDA)	7195
		SOPORTE PARA TRANSMISIÓN (DSG)	7212

GOLF VR6

MISCELÁNEOS / AUTOMOTIVE RUBBER PARTS			
	99-04	BUJES PARA HORQUILLA INFERIOR CHICO Y GRANDE (POLIURETANO KIT)	9800
		BUJES PARA HORQUILLA INFERIOR (POLIURETANO KIT CON CASQUILLO)	9809



CONTINUACIÓN... GOLF VR6

 		APLICACIÓN / DESCRIPTION	DAI PARTS #
MISCELÁNEOS / AUTOMOTIVE RUBBER PARTS			
99-04		BUJE PARA HORQUILLA INFERIOR GRANDE (CON CEJA BUJE INTERNO CHICO)	64650
		BUJE PARA HORQUILLA INFERIOR GRANDE (CON CEJA BUJE INTERNO GRANDE)	64651
		BUJE PARA HORQUILLA INFERIOR GRANDE (SIN CEJA BUJE INTERO GRANDE)	64760



JETTA

SOPORTES / TRANSMISSION & MOTOR MOUNTS			
L4 2.0	08-10	SOPORTE PARA MOTOR DERECHO	7654-H



		APLICACIÓN / DESCRIPTION	DAI PARTS #	DAI KIT PARTS #
BASES PARA AMORTIGUADOR / STRUT MOUNTS				
80-84		BASE PARA AMORTIGUADOR FRONTAL IZQUIERDA Y DERECHA	1890	1890-KIT
		BALERO PARA BASE DE AMORTIGUADOR 1808, 1852, 1886, 1890, 7055 Y 7103	6137	



CONTINUACIÓN... JETTA

28	APLICACIÓN / DESCRIPTION	DAI PARTS #	DAI KIT PARTS #
BASES PARA AMORTIGUADOR / STRUT MOUNTS			
80-05	BASE PARA AMORTIGUADOR FRONTAL IZQUIERDA Y DERECHA	1815	1815-KIT
	BASE PARA AMORTIGUADOR FRONTAL IZQUIERDA Y DERECHA	1852	1852-KIT
	BALERO PARA BASE DE AMORTIGUADOR	6119	



28	APLICACIÓN / DESCRIPTION	DAI PARTS #
MISCELÁNEOS / AUTOMOTIVE RUBBER PARTS		
83-87	SOPORTE PARA FILTRO DE AIRE	6162
99-04	BUJE PARA HORQUILLA CHICO (VR6)	DAI-191-407-182

JETTA BICENTENARIO

SOPORTES / TRANSMISSION & MOTOR MOUNTS			
L4 1.9	08-10	SOPORTE PARA MOTOR TRASERO STD. TORQUE STRUT	7776



CONTINUACIÓN... JETTA BICENTENARIO

		APLICACIÓN / DESCRIPTION	DAI PARTS #
SOPORTES / TRANSMISSION & MOTOR MOUNTS			
L4 2.0	06-16	SOPORTE PARA TRANSMISIÓN (AUT.)	7211
	08-10	SOPORTE PARA MOTOR DERECHO (DIESEL)	7654-H
	10-11	SOPORTE PARA MOTOR TRASERO STD. TORQUE STRUT	7776
	11-14	SOPORTE PARA TRANSMISIÓN STD. Y AUT.	7212
SOPORTE PARA MOTOR TRASERO		7254	
L4 2.0 TDI	09-10	SOPORTE PARA TRANSMISIÓN (AUT.)	7211
	09-14	SOPORTE PARA TRANSMISIÓN STD. Y AUT.	7212
		SOPORTE PARA MOTOR TRASERO	7254
L5 2.5	06-14	SOPORTE PARA TRANSMISIÓN STD. Y AUT.	7212
		SOPORTE PARA MOTOR TRASERO	7254
	09-10	SOPORTE PARA TRANSMISIÓN AUT.	7211
	10-11	SOPORTE PARA MOTOR DERECHO (DIESEL)	7654-H
		SOPORTE PARA MOTOR TRASERO STD. TORQUE STRUT	7776
	10-14	SOPORTE PARA MOTOR TRASERO INFERIOR (SIN CUERDA)	7195
10-15	SOPORTE PARA MOTOR TRASERO SUPERIOR (CON CUERDA)	7194	

**SOPORTES
TRANSMISSION & MOTOR MOUNTS**



7194



7195



7211



7212



7254



7654-H



7776

CUBRE POLVOS / C.V. BOOTS		
10-14	CUBRE POLVO IZQUIERDO Y DERECHO LADO CAJA	63110
	CUBRE POLVO IZQUIERDO Y DERECHO LADO RUEDA	63111

**CUBRE POLVOS
C.V. BOOTS**



63110



63111



CONTINUACIÓN... JETTA BICENTENARIO

		APLICACIÓN / DESCRIPTION	DAI PARTS #
MISCELÁNEOS / AUTOMOTIVE RUBBER PARTS			
10-14		BUJE PARA HORQUILLA INFERIOR CHICO	DAI-1426011
		BUJE PARA HORQUILLA INFERIOR GRANDE	DAI-1426023
		TORNILLO ESTABILIZADOR FRONTAL	DAI-2126010
		TOPE PARA AMORTIGUADOR TRASERO IZQUIERDO Y DERECHO	D-050

JETTA A2

SOPORTES / TRANSMISSION & MOTOR MOUNTS			
L4 1.7 L4 1.8 L4 2.0	87-92	SOPORTE PARA MOTOR DERECHO	6659
		REPUESTO SOPORTE DE MOTOR FRONTAL (1ra VERSIÓN)	1982
		SOPORTE PARA MOTOR FRONTAL STD.	6658
		SOPORTE PARA MOTOR FRONTAL (CON BASE)	6841
		SOPORTE PARA MOTOR FRONTAL AUT.	6692
		SOPORTE PARA TRANSMISIÓN STD.	6660
		SOPORTE PARA TRANSMISIÓN AUT.	6693



CONTINUACIÓN... JETTA A2

28		APLICACIÓN / DESCRIPTION	DAI PARTS #	DAI KIT PARTS #
BASES PARA AMORTIGUADOR / STRUT MOUNTS				
85-92		REPUESTO BASE DE AMORTIGUADOR TRASERA IZQUIERDA Y DERECHA	75	
		REPUESTO BASE DE AMORTIGUADOR TRASERA IZQUIERDA Y DERECHA	76	
		BASE PARA AMORTIGUADOR FRONTAL IZQUIERDA Y DERECHA	1860	
		BASE PARA AMORTIGUADOR FRONTAL IZQUIERDA Y DERECHA	1886	1886-KIT
		BASE PARA AMORTIGUADOR TRASERA IZQUIERDA Y DERECHA	6739	6739-KIT
		BASE PARA AMORTIGUADOR TRASERA IZQUIERDA Y DERECHA	7301	
		BALERO PARA BASE DE AMORTIGUADOR 1808, 1852, 1886, 1890, 7055 Y 7103	6137	



28		APLICACIÓN / DESCRIPTION	DAI PARTS #
CUBRE POLVOS / C.V. BOOTS			
87-92		CUBRE POLVO IZQUIERDO Y DERECHO LADO RUEDA	6305
		CUBRE POLVO IZQUIERDO Y DERECHO LADO CAJA	6302



CONTINUACIÓN... JETTA A2

	28	APLICACIÓN / DESCRIPTION	DAI PARTS #
CUBRE POLVOS / C.V. BOOTS			
87-92		CUBRE POLVO IZQUIERDO Y DERECHO DE DIRECCIÓN STD.	6373
		CUBRE POLVO IZQUIERDO Y DERECHO DE DIRECCIÓN HID.	6374



MISCELÁNEOS / AUTOMOTIVE RUBBER PARTS			
85-92		TOPE PARA AMORTIGUADOR TRASERO IZQUIERDO Y DERECHO	D-050
		TOPE PARA AMORTIGUADOR FRONTAL IZQUIERDO Y DERECHO (HULE)	331
		AUMENTO PARA RESORTE	409
		TOPE PARA AMORTIGUADOR TRASERO IZQUIERDO Y DERECHO (HULE)	2005
		SOPORTE O BASE PARA CARBURADOR	1861
		SOPORTE PARA RADIADOR	6161
		TORNILLO ESTABILIZADOR FRONTAL IZQUIERDO Y DERECHO	6097
		GOMA SUJETADORA DE ESCAPE	6563
		BUJE PARA BARRA TRASERA EXTERIOR	64740
		GOMA PARA BARRA ESTABILIZADORA	64729
		TOPE PARA AMORTIGUADOR Y CUBRE POLVO FRONTAL IZQUIERDO Y DERECHO	DAI-074-KIT
		BUJE PARA HORQUILLA CHICO	DAI-191-407-182

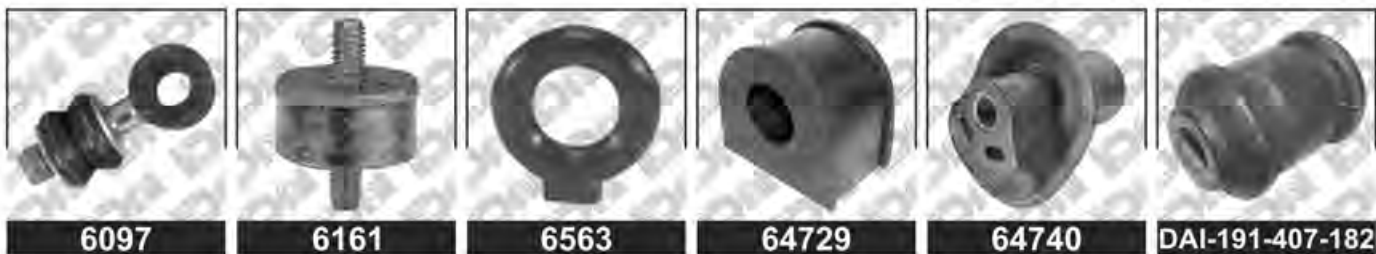

JETTA A3

  28		APLICACIÓN / DESCRIPTION	DAI PARTS #
SOPORTES / TRANSMISSION & MOTOR MOUNTS			
L4 1.8	93-99	SOPORTE PARA MOTOR FRONTAL	6661
		SOPORTE PARA MOTOR TRASERO (CON BASE)	6842
		SOPORTE PARA MOTOR TRASERO	6662
		SOPORTE PARA TRANSMISIÓN STD.	6663
		SOPORTE PARA TRANSMISIÓN AUT.	6693
		SOPORTE PARA TRANSMISIÓN STD.	6663-S



 28		APLICACIÓN / DESCRIPTION	DAI PARTS #	DAI KIT PARTS #
BASES PARA AMORTIGUADOR / STRUT MOUNTS				
93-99	BASE PARA AMORTIGUADOR FRONTAL IZQUIERDA Y DERECHA		1886	1886-KIT
	BASE PARA AMORTIGUADOR TRASERA IZQUIERDA Y DERECHA		6739	6739-KIT



CONTINUACIÓN... JETTA A3

28	APLICACIÓN / DESCRIPTION	DAI PARTS #	DAI KIT PARTS #
BASES PARA AMORTIGUADOR / STRUT MOUNTS			
93-99	BASE PARA AMORTIGUADOR TRASERA IZQUIERDA Y DERECHA	7301	
	REPUESTO BASE DE AMORTIGUADOR TRASERA IZQUIERDA Y DERECHA	75	
	REPUESTO BASE DE AMORTIGUADOR TRASERA IZQUIERDA Y DERECHA	76	
	BALERO PARA BASE DE AMORTIGUADOR 1808, 1852, 1886, 1890, 7055 Y 7103	6137	



28	APLICACIÓN / DESCRIPTION	DAI PARTS #
CUBRE POLVOS / C.V. BOOTS		
93-99	CUBRE POLVO IZQUIERDO Y DERECHO DE DIRECCIÓN STD.	6373
	CUBRE POLVO IZQUIERDO Y DERECHO DE DIRECCIÓN HID.	6374
	CUBRE POLVO IZQUIERDO LADO CAJA	6382
	CUBRE POLVO DERECHO LADO CAJA	6383
	CUBRE POLVO IZQUIERDO Y DERECHO LADO RUEDA	6384



CONTINUACIÓN... JETTA A3

 		APLICACIÓN / DESCRIPTION	DAI PARTS #
MISCELÁNEOS / AUTOMOTIVE RUBBER PARTS			
93-99		TOPE PARA AMORTIGUADOR FRONTAL IZQUIERDO Y DERECHO	D-074
		TOPE PARA AMORTIGUADOR FRONTAL IZQUIERDO Y DERECHO (HULE)	331
		TOPE PARA AMORTIGUADOR TRASERO IZQUIERDO Y DERECHO (HULE)	2005
		GOMA SUJETADORA DE ESCAPE	6564
		GOMA SUJETADORA DE ESCAPE	6699
		BUJE PARA BARRA TRASERA EXTERIOR	64750
		TORNILLO ESTABILIZADOR FRONTAL	DAI-1H0-411-315
		BUJE PARA HORQUILLA CHICO	DAI-191-407-182

MISCELÁNEOS AUTOMOTIVE RUBBER PARTS	
	
D-074	331
	
2005	6564



JETTA A4

SOPORTES / TRANSMISSION & MOTOR MOUNTS			
L4 1.8 L4 2.0	98-14	SOPORTE PARA MOTOR DERECHO	6976-H
		SOPORTE PARA TRANSMISIÓN	6977
		SOPORTE PARA MOTOR TRASERO	6978

SOPORTES TRANSMISSION & MOTOR MOUNTS	
	
6976-H	6977



CONTINUACIÓN... JETTA A4

28		APLICACIÓN / DESCRIPTION	DAI PARTS #	DAI KIT PARTS #	BASES PARA AMORTIGUADOR STRUT MOUNTS	
		BASES PARA AMORTIGUADOR / STRUT MOUNTS				
98-14		BASE PARA AMORTIGUADOR FRONTAL IZQUIERDA Y DERECHA	1815	1815-KIT		
		BASE PARA AMORTIGUADOR FRONTAL IZQUIERDA Y DERECHA	1816	6759-KIT		
		BASE PARA AMORTIGUADOR FRONTAL IZQUIERDA Y DERECHA	6759	6759-KIT		
		BASE PARA AMORTIGUADOR TRASERA IZQUIERDA Y DERECHA	6906			
		REPUESTO BASE DE AMORTIGUADOR TRASERA IZQUIERDA Y DERECHA	75			
		REPUESTO BASE DE AMORTIGUADOR TRASERA IZQUIERDA Y DERECHA	76			
		BALERO PARA BASE DE AMORTIGUADOR (1815)	6119			

CUBRE POLVOS / C.V. BOOTS

98-07		CUBRE POLVO IZQUIERDO Y DERECHO LADO CAJA	6312
		CUBRE POLVO IZQUIERDO Y DERECHO LADO CAJA	6314
		CUBRE POLVO IZQUIERDO Y DERECHO LADO RUEDA	6384



CONTINUACIÓN... JETTA A4

	 28	APLICACIÓN / DESCRIPTION	DAI PARTS #
CUBRE POLVOS / C.V. BOOTS			
98-14		CUBRE POLVO IZQUIERDO Y DERECHO DE DIRECCIÓN STD.	6345
		CUBRE POLVO IZQUIERDO Y DERECHO DE DIRECCIÓN STD.	6373
		CUBRE POLVO IZQUIERDO Y DERECHO DE DIRECCIÓN HID.	6374
08-14		CUBRE POLVO IZQUIERDO Y DERECHO LADO RUEDA	63118



MISCELÁNEOS / AUTOMOTIVE RUBBER PARTS		
98-11	TORNILLO ESTABILIZADOR FRONTAL	DAI-1J0-411-315-C
98-14	TOPE PARA AMORTIGUADOR TRASERO IZQUIERDO Y DERECHO	D-050
	TOPE PARA AMORTIGUADOR FRONTAL IZQUIERDO Y DERECHO	D-074
	TOPE PARA AMORTIGUADOR Y CUBRE POLVO FRONTAL IZQUIERDO Y DERECHO	DAI-074-KIT
	BUJES PARA HORQUILLA INFERIOR CHICO Y GRANDE (POLIURETANO KIT)	9800
	BUJE PARA HORQUILLA INFERIOR GRANDE (CON CEJA BUJE INTERNO CHICO)	64650
	BUJE PARA HORQUILLA INFERIOR GRANDE (CON CEJA BUJE INTERNO GRANDE)	64651

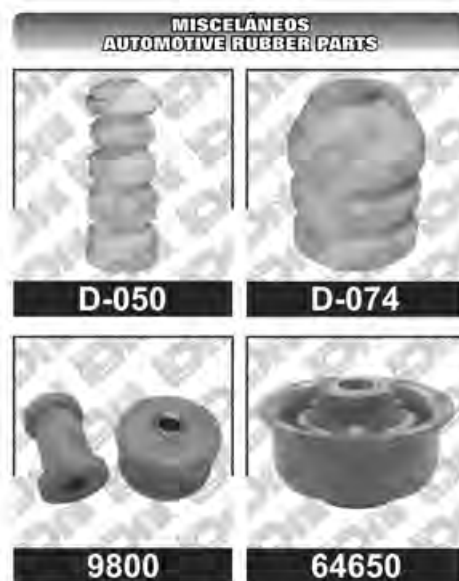

CONTINUACIÓN... JETTA A4



 28		APLICACIÓN / DESCRIPTION	DAI PARTS #
MISCELÁNEOS / AUTOMOTIVE RUBBER PARTS			
98-14		BUJE PARA HORQUILLA INFERIOR GRANDE (SIN CEJA BUJE INTERO GRANDE)	64760
		GOMA PARA BARRA ESTABILIZADORA IZQUIERDA	64719
		GOMA PARA CAJA DE DIRECCIÓN	64815
		GOMA PARA BARRA ESTABILIZADORA DERECHA	64816
		TORNILLO ESTABILIZADOR FRONTAL DERECHO	DAI-2126002
		BUJE PARA HORQUILLA CHICO	DAI-191-407-182
		BUJES PARA HORQUILLA INFERIOR (POLIURETANO KIT CON CASQUILLO)	9809
		BUJE PARA EJE TRASERO IZQUIERDO Y DERECHO	DAI-1426037

JETTA A5

 28		APLICACIÓN / DESCRIPTION	DAI PARTS #	DAI KIT PARTS #
BASES PARA AMORTIGUADOR / STRUT MOUNTS				
06-10		BALERO PARA BASE DE AMORTIGUADOR FRONTAL IZQUIERDO Y DERECHO (7214)	6145	



CONTINUACIÓN... JETTA A5

		APLICACIÓN / DESCRIPTION	DAI PARTS #
MISCELÁNEOS / AUTOMOTIVE RUBBER PARTS			
	06-10	BUJE PARA HORQUILLA INFERIOR CHICO	DAI-1426011
		TORNILLO ESTABILIZADOR FRONTAL	DAI-2126010



JETTA A6

	APLICACIÓN / DESCRIPTION	DAI PARTS #	DAI KIT PARTS #
BASES PARA AMORTIGUADOR / STRUT MOUNTS			
10-14	BALERO PARA BASE DE AMORTIGUADOR FRONTAL IZQUIERDO Y DERECHO (7214)	6145	



		APLICACIÓN / DESCRIPTION	DAI PARTS #
MISCELÁNEOS / AUTOMOTIVE RUBBER PARTS			
	10-12	BUJE PARA HORQUILLA INFERIOR CHICO	DAI-1426011
		TORNILLO ESTABILIZADOR FRONTAL	DAI-2126010
	10-14	BUJE PARA HORQUILLA INFERIOR GRANDE	DAI-1426023



JETTA VR6

  28		APLICACIÓN / DESCRIPTION	DAI PARTS #
CUBRE POLVOS / C.V. BOOTS			
99-04		CUBRE POLVO IZQUIERDO Y DERECHO DE DIRECCIÓN STD.	6373
		CUBRE POLVO IZQUIERDO Y DERECHO DE DIRECCIÓN HID.	6374
		CUBRE POLVO IZQUIERDO LADO CAJA	6382
		CUBRE POLVO DERECHO LADO CAJA	6383
		CUBRE POLVO IZQUIERDO Y DERECHO LADO RUEDA	6384
		CUBRE POLVO IZQUIERDO LADO CAJA	6395



MISCELÁNEOS / AUTOMOTIVE RUBBER PARTS			
99-04		BUJES PARA HORQUILLA INFERIOR CHICO Y GRANDE (POLIURETANO KIT)	9800
		BUJES PARA HORQUILLA INFERIOR (POLIURETANO KIT CON CASQUILLO)	9809
		BUJE PARA HORQUILLA INFERIOR GRANDE (CON CEJA BUJE INTERNO CHICO)	64650
		BUJE PARA HORQUILLA INFERIOR GRANDE (CON CEJA BUJE INTERNO GRANDE)	64651
		BUJE PARA HORQUILLA INFERIOR GRANDE (SIN CEJA BUJE INTERIOR GRANDE)	64760





LUPO

  28		APLICACIÓN / DESCRIPTION	DAI PARTS #
SOPORTES / TRANSMISSION & MOTOR MOUNTS			
L4 1.6	05-09	SOPORTE PARA MOTOR DERECHO	7057-H
		SOPORTE PARA MOTOR TRASERO	7058
		SOPORTE PARA TRANSMISIÓN	7060



 28		APLICACIÓN / DESCRIPTION	DAI PARTS #	DAI KIT PARTS #
BASES PARA AMORTIGUADOR / STRUT MOUNTS				
05-09	BASE PARA AMORTIGUADOR TRASERA IZQUIERDA Y DERECHA		6906	
	BALERO PARA BASE DE AMORTIGUADOR FRONTAL IZQUIERDO Y DERECHO (7214)		6145	
	BASE PARA AMORTIGUADOR FRONTAL IZQUIERDA Y DERECHA		7214	7214-KIT



  28		APLICACIÓN / DESCRIPTION	DAI PARTS #
CUBRE POLVOS / C.V. BOOTS			
	05-09	CUBRE POLVO IZQUIERDO Y DERECHO LADO RUEDA	63147
		CUBRE POLVO IZQUIERDO Y DERECHO LADO CAJA	63148



CONTINUACIÓN... LUPO

	28	APLICACIÓN / DESCRIPTION	DAI PARTS #
CUBRE POLVOS / C.V. BOOTS			
05-09		CUBRE POLVO IZQUIERDO Y DERECHO DE DIRECCIÓN	63149



MISCELÁNEOS / AUTOMOTIVE RUBBER PARTS

05-09	TOPE PARA AMORTIGUADOR TRASERO IZQUIERDO Y DERECHO	D-050
	BUJE INFERIOR GRANDE	64812
	BUJE PARA EJE TRASERO IZQUIERDO Y DERECHO	DAI-1426037
	BUJE PARA HORQUILLA INFERIOR CHICO	DAI-1426003
	TORNILLO ESTABILIZADOR FRONTAL	DAI-2126004
	BUJE PARA EJE TRASERO	DAI-1J0-501-541



PANEL

SOPORTES / TRANSMISSION & MOTOR MOUNTS

4 Hop 1500 1600	65-88	SOPORTE PARA MOTOR IZQUIERDO Y DERECHO	1835
		SOPORTE PARA TRANSMISIÓN	6611



CONTINUACIÓN... PANEL

  28		APLICACIÓN / DESCRIPTION	DAI PARTS #
SOPORTES / TRANSMISSION & MOTOR MOUNTS			
4 Hop 1800	89-00	SOPORTE PARA MOTOR IZQUIERDO Y DERECHO	1900
		SOPORTE PARA TRANSMISIÓN	1942
		REPUESTO PARA SOPORTE DE TRANSMISIÓN (1942)	1942-9



CUBRE POLVOS / C.V. BOOTS		
65-00	CUBRE POLVO IZQUIERDO Y DERECHO LADO CAJA	6303



MISCELÁNEOS / AUTOMOTIVE RUBBER PARTS		
65-00	COPLÉ PARA DIRECCIÓN (SINFÍN DE .750 mm NO REQUIERE PERNOS)	612
	GALLETA PARA DIRECCIÓN STD. (NO REQUIERE PERNOS COMPLETO 612)	624



PASSAT

 28		APLICACIÓN / DESCRIPTION	DAI PARTS #
SOPORTES / TRANSMISSION & MOTOR MOUNTS			
L4 1.8	91-94	SOPORTE PARA MOTOR FRONTAL	6658
		SOPORTE PARA MOTOR TRASERO	6659
	98-05	SOPORTE PARA MOTOR IZQUIERDO Y DERECHO	7452-H
		SOPORTE PARA TRANSMISIÓN STD. IZQUIERDO Y DERECHO	7581
	97-01	SOPORTE PARA TRANSMISIÓN AUT. IZQUIERDO Y DERECHO	7582
14-15	SOPORTE PARA MOTOR DERECHO	7654-H	
L4 1.9	91-94	SOPORTE PARA MOTOR FRONTAL	6658
	92-94	SOPORTE PARA MOTOR TRASERO	6659
	95-97	SOPORTE PARA MOTOR FRONTAL	6661
		SOPORTE PARA MOTOR TRASERO STD.	6662
		SOPORTE PARA TRANSMISIÓN STD.	6663
	1998	SOPORTE PARA TRANSMISIÓN STD.	6663-S
1998	SOPORTE PARA MOTOR IZQ. Y DER.	7452-H	
L4 2.0	91-94	SOPORTE PARA MOTOR FRONTAL	6658
		SOPORTE PARA MOTOR TRASERO AUT.	6659
	95-96	SOPORTE PARA MOTOR FRONTAL	6661
		SOPORTE PARA MOTOR TRASERO STD.	6662
		SOPORTE PARA TRANSMISIÓN STD.	6663
		SOPORTE PARA TRANSMISIÓN STD.	6663-S
	08-10	SOPORTE PARA MOTOR DERECHO	7654-H

**SOPORTES
TRANSMISSION & MOTOR MOUNTS**

6658

6659

6661

6662

6663

6663-S

7452-H

7581

7582

7654-H

CONTINUACIÓN... PASSAT

 		APLICACIÓN / DESCRIPTION	DAI PARTS #
SOPORTES / TRANSMISSION & MOTOR MOUNTS			
L5 2.5	05-11	SOPORTE PARA MOTOR TRASERO SUPERIOR (CON CUERDA)	7194
		SOPORTE PARA MOTOR TRASERO INFERIOR (SIN CUERDA)	7195
		SOPORTE PARA TRANSMISIÓN AUT.	7211
		SOPORTE PARA TRANSMISIÓN DSG.	7212
		SOPORTE PARA MOTOR TRASERO	7254
V6 2.8	93-97	SOPORTE PARA MOTOR FRONTAL	6661
		SOPORTE PARA TRANSMISIÓN	6660
	98-05	SOPORTE PARA MOTOR TRASERO IZQUIERDO Y DERECHO	6662
		SOPORTE PARA MOTOR IZQUIERDO Y DERECHO	7452-H
		SOPORTE PARA TRANSMISIÓN AUT. IZQUIERDO Y DERECHO	7582



		APLICACIÓN / DESCRIPTION	DAI PARTS #	DAI KIT PARTS #
BASES PARA AMORTIGUADOR / STRUT MOUNTS				
90-05		BASE PARA AMORTIGUADOR FRONTAL IZQUIERDA Y DERECHA	1886	1886-KIT



CONTINUACIÓN... PASSAT

28	APLICACIÓN / DESCRIPTION	DAI PARTS #	DAI KIT PARTS #
BASES PARA AMORTIGUADOR / STRUT MOUNTS			
90-05	BALERO PARA BASE DE AMORTIGUADOR 1808, 1852, 1886, 7055, 7103 Y 1890	6137	
97-01	BASE PARA AMORTIGUADOR FRONTAL IZQUIERDA Y DERECHA	7035	
05-10	BALERO PARA BASE DE AMORTIGUADOR FRONTAL IZQUIERDO Y DERECHO 7214	6145	



MISCELÁNEOS / AUTOMOTIVE RUBBER PARTS		
86-96	BUJES PARA HORQUILLA INFERIOR CHICO Y GRANDE (POLIURETANO KIT)	9800
	TOPE PARA AMORTIGUADOR FRONTAL IZQUIERDO Y DERECHO	D-074
	BUJE PARA HORQUILLA CHICO	DAI-191-407-182
94-04	BUJE PARA HORQUILLA SUPERIOR	DAI-1426020
98-13	BUJES PARA HORQUILLA INFERIOR (POLIURETANO KIT CON CASQUILLO)	9809
05-18	BUJE PARA HORQUILLA INFERIOR CHICO	DAI-1426011
	TORNILLO ESTABILIZADOR FRONTAL	DAI-2126010
12-18	BUJE PARA HORQUILLA INFERIOR GRANDE	DAI-1426023



PASSAT CC

		APLICACIÓN / DESCRIPTION	DAI PARTS #
SOPORTES / TRANSMISSION & MOTOR MOUNTS			
L4 2.0	10-12	SOPORTE PARA MOTOR TRASERO SUPERIOR (CON CUERDA)	7194
		SOPORTE PARA MOTOR TRASERO INFERIOR (SIN CUERDA)	7195
		SOPORTE PARA TRANSMISIÓN AUT.	7211
		SOPORTE PARA MOTOR TRASERO	7254
2010		SOPORTE PARA MOTOR DERECHO	7654-H



		APLICACIÓN / DESCRIPTION	DAI PARTS #	DAI KIT PARTS #
BASES PARA AMORTIGUADOR / STRUT MOUNTS				
08-10		BALERO PARA BASE DE AMORTIGUADOR FRONTAL IZQUIERDO Y DERECHO (7214)	6145	



MISCELÁNEOS / AUTOMOTIVE RUBBER PARTS		
08-10	TORNILLO ESTABILIZADOR FRONTAL	DAI-2126010
08-15	BUJE PARA HORQUILLA INFERIOR CHICO	DAI-1426011



POINTER



  28		APLICACIÓN / DESCRIPTION	DAI PARTS #
SOPORTES / TRANSMISSION & MOTOR MOUNTS			
L4 1.8	98-10	SOPORTE PARA MOTOR IZQUIERDO Y DERECHO	1900
		GOMA LIMITADORA FRONTAL	6426
		SOPORTE PARA TRANSMISIÓN	6907

6907

 28		APLICACIÓN / DESCRIPTION	DAI PARTS #	DAI KIT PARTS #
BASES PARA AMORTIGUADOR / STRUT MOUNTS				
97-10	BASE PARA AMORTIGUADOR TRASERA IZQUIERDA Y DERECHA			6739-KIT
	REPUESTO PARA BASE PARA AMORTIGUADOR TRASERA IZQUIERDA Y DERECHA		75	
	REPUESTO PARA BASE PARA AMORTIGUADOR TRASERA IZQUIERDA Y DERECHA		76	
98-05	BASE PARA AMORTIGUADOR FRONTAL IZQUIERDA Y DERECHA		7103	
98-10	BALERO PARA BASE DE AMORTIGUADOR 1808, 1852, 1886, 7055, 7103 Y 1890		6137	
06-10	BASE PARA AMORTIGUADOR FRONTAL IZQUIERDA Y DERECHA		7055	7055-KIT



CONTINUACIÓN... POINTER

  28		APLICACIÓN / DESCRIPTION	DAI PARTS #
CUBRE POLVOS / C.V. BOOTS			
98-10		CUBRE POLVO IZQUIERDO Y DERECHO LADO CAJA	6302
		CUBRE POLVO IZQUIERDO Y DERECHO LADO RUEDA	6305
		CUBRE POLVO IZQUIERDO PARA DE DIRECCIÓN	6344



MISCELÁNEOS / AUTOMOTIVE RUBBER PARTS			
98-10		TOPE PARA AMORTIGUADOR FRONTAL IZQUIERDO Y DERECHO	D-015
		TOPE PARA AMORTIGUADOR TRASERO IZQUIERDO Y DERECHO	D-050
		TOPE PARA AMORTIGUADOR TRASERO IZQUIERDO Y DERECHO	D-071
		TOPE PARA AMORTIGUADOR TRASERO IZQUIERDO Y DERECHO	2005
		GOMA SUJETADORA DE ESCAPE	6569
		TOPE PARA AMORTIGUADOR Y CUBRE POLVO FRONTAL IZQUIERDO Y DERECHO	DAI-015-KIT
		TOPE Y CUBRE POLVO TRASERO IZQUIERDO Y DERECHO	DAI-071-KIT



CONTINUACIÓN... POINTER

 28		APLICACIÓN / DESCRIPTION	DAI PARTS #
MISCELÁNEOS / AUTOMOTIVE RUBBER PARTS			
98-10		BUJE PARA HORQUILLA	64720
		GOMA PARA BARRA ESTABILIZADORA	64727
		BUJE PARA BARRA DE DIRECCIÓN	DAI-1426001

**MISCELÁNEOS
AUTOMOTIVE RUBBER PARTS**



64720



64727



POINTER PICK UP

SOPORTES / TRANSMISSION & MOTOR MOUNTS			
L4 1.8	98-08	SOPORTE PARA MOTOR IZQUIERDO Y DERECHO	1900
		GOMA LIMITADORA FRONTAL	6426
		SOPORTE PARA TRANSMISIÓN	6907

**SOPORTES
TRANSMISSION & MOTOR MOUNTS**



1900



6426



 28		APLICACIÓN / DESCRIPTION	DAI PARTS #	DAI KIT PARTS #
BASES PARA AMORTIGUADOR / STRUT MOUNTS				
98-08		BASE PARA AMORTIGUADOR FRONTAL IZQUIERDA Y DERECHA	7055	7055-KIT

**BASES PARA AMORTIGUADOR
STRUT MOUNTS**



7055



7055-KIT



CONTINUACIÓN... POINTER PICK UP

28	APLICACIÓN / DESCRIPTION	DAI PARTS #	DAI KIT PARTS #
BASES PARA AMORTIGUADOR / STRUT MOUNTS			
98-08	BALERO PARA BASE DE AMORTIGUADOR 1808, 1852, 1886, 7055, 7103 Y 1890	6137	

**BASES PARA AMORTIGUADOR
STRUT MOUNTS**



6137

28	APLICACIÓN / DESCRIPTION	DAI PARTS #
MISCELÁNEOS / AUTOMOTIVE RUBBER PARTS		
98-08	TOPE PARA AMORTIGUADOR TRASERO IZQUIERDO Y DERECHO	D-071
	TOPE PARA AMORTIGUADOR Y CUBRE POLVO FRONTAL IZQUIERDO Y DERECHO	DAI-015-KIT
	TOPE PARA AMORTIGUADOR Y CUBRE POLVO TRASERO IZQUIERDO Y DERECHO	DAI-071-KIT
98-10	BUJE PARA BARRA DE DIRECCIÓN	DAI-1426001

**MISCELÁNEOS
AUTOMOTIVE RUBBER PARTS**



D-071



DAI-015-KIT



DAI-071-KIT



DAI-1426001

POLO

SOPORTES / TRANSMISSION & MOTOR MOUNTS			
L4 1.6	03-09	SOPORTE PARA MOTOR DERECHO	7057-H
		SOPORTE PARA MOTOR TRASERO	7058

**SOPORTES
TRANSMISSION & MOTOR MOUNTS**



7057-H



7058



CONTINUACIÓN... POLO

 28		APLICACIÓN / DESCRIPTION	DAI PARTS #
SOPORTES / TRANSMISSION & MOTOR MOUNTS			
L4 1.6	03-09	SOPORTE PARA TRANSMISIÓN	7060
	13-17	SOPORTE PARA TRANSMISIÓN	7770
		SOPORTE PARA MOTOR TRASERO TORQUE STRUT	7773
L4 2.0	03-09	SOPORTE PARA MOTOR DERECHO	7057-H
		SOPORTE PARA MOTOR TRASERO	7058
		SOPORTE PARA TRANSMISIÓN	7060



 28		APLICACIÓN / DESCRIPTION	DAI PARTS #	DAI KIT PARTS #
BASES PARA AMORTIGUADOR / STRUT MOUNTS				
03-09		BASE PARA AMORTIGUADOR TRASERA IZQUIERDA Y DERECHA	6906	
		BASE PARA AMORTIGUADOR FRONTAL IZQUIERDA Y DERECHA	7214	7214-KIT
		BALERO PARA BASE DE AMORTIGUADOR FRONTAL IZQUIERDO Y DERECHO (7214)	6145	



CONTINUACIÓN... POLO

	 28	APLICACIÓN / DESCRIPTION	DAI PARTS #
MISCELÁNEOS / AUTOMOTIVE RUBBER PARTS			
03-09		TOPE PARA AMORTIGUADOR TRASERO IZQUIERDO Y DERECHO	D-050
		TOPE PARA AMORTIGUADOR FRONTAL IZQUIERDO Y DERECHO	D-074
		BUJE INFERIOR GRANDE	64812
		BUJE PARA HORQUILLA INFERIOR CHICO	DAI-1426003
		TORNILLO ESTABILIZADOR FRONTAL	DAI-2126004
03-14		BUJE PARA EJE TRASERO	DAI-1J0-501-541
		BUJE PARA EJE TRASERO IZQUIERDO Y DERECHO	DAI-1426037
13-14		BUJES PARA HORQUILLA INFERIOR CHICO Y GRANDE (POLIURETANO KIT)	9800
		BUJES PARA HORQUILLA INFERIOR (POLIURETANO KIT CON CASQUILLO)	9809

**MISCELÁNEOS
AUTOMOTIVE RUBBER PARTS**



D-050 D-074

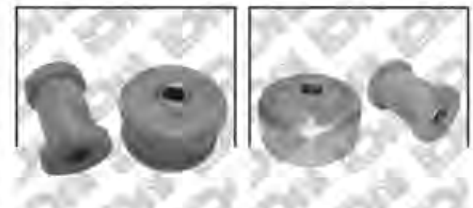

9800 9809

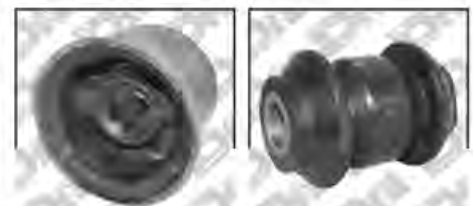

64812 DAI-1426003



DAI-1426037 DAI-2126004 DAI-1J0-501-541

POLO SEDAN

SOportes / TRANSMISSION & MOTOR MOUNTS			
L4 1.6	03-07	SOORTE PARA MOTOR DERECHO	7057-H
		SOORTE PARA MOTOR TRASERO	7058

**SOportes
TRANSMISSION & MOTOR MOUNTS**



7057-H 7058



CONTINUACIÓN... POLO SEDAN

  28		APLICACIÓN / DESCRIPTION	DAI PARTS #
SOPORTES / TRANSMISSION & MOTOR MOUNTS			
L4 1.6	03-07	SOPORTE PARA TRANSMISIÓN	7060



MISCELÁNEOS / AUTOMOTIVE RUBBER PARTS			
	03-07	TOPE PARA AMORTIGUADOR TRASERO IZQUIERDO Y DERECHO	D-050
		TOPE PARA AMORTIGUADOR FRONTAL IZQUIERDO Y DERECHO	D-074

RABBIT

 28		APLICACIÓN / DESCRIPTION	DAI PARTS #	DAI KIT PARTS #
BASES PARA AMORTIGUADOR / STRUT MOUNTS				
75-84		BASE PARA AMORTIGUADOR FRONTAL IZQUIERDA Y DERECHA	1890	1890-KIT
		BALERO PARA BASE DE AMORTIGUADOR 1808, 1852, 1886, 7055, 7103 Y 1890	6137	



ROUTAN

28		APLICACIÓN / DESCRIPTION	DAI PARTS #
SOPORTES / TRANSMISSION & MOTOR MOUNTS			
V6 3.6	11-16	REPUESTO PARA SOPORTE DE TRANSMISIÓN (7337)	7337-9
	11-14	SOPORTE PARA MOTOR DERECHO	7567-H
V6 3.8	08-10	REPUESTO PARA SOPORTE DE TRANSMISIÓN (7337)	7337-9
		REPUESTO PARA SOPORTE DE MOTOR FRONTAL	7716-9
		REPUESTO PARA SOPORTE DE MOTOR TRASERO	7723-9
	09-15	SOPORTE PARA MOTOR FRONTAL	7279
		SOPORTE PARA MOTOR TRASERO	7310
		SOPORTE PARA TRANSMISIÓN AUT.	7426
		SOPORTE PARA MOTOR DERECHO	7567-H
V6 4.0	08-10	REPUESTO PARA SOPORTE DE TRANSMISIÓN (7337)	7337-9
		REPUESTO PARA SOPORTE DE MOTOR FRONTAL	7716-9
		REPUESTO PARA SOPORTE DE MOTOR TRASERO	7723-9
	09-15	SOPORTE PARA MOTOR FRONTAL	7279
		SOPORTE PARA MOTOR TRASERO	7310
		SOPORTE PARA TRANSMISIÓN AUT.	7426
		SOPORTE PARA MOTOR DERECHO	7567-H

SOPORTES TRANSMISSION & MOTOR MOUNTS

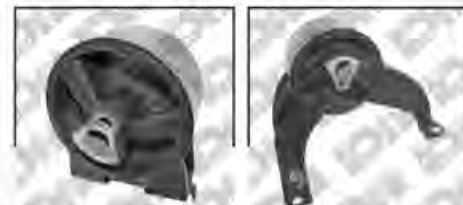

7279 **7310**



7426 **7337-9**



7567-H **7716-9**



7723-9

28		APLICACIÓN / DESCRIPTION	DAI PARTS #	DAI KIT PARTS #
BASES PARA AMORTIGUADOR / STRUT MOUNTS				
09-15		BASE PARA AMORTIGUADOR FRONTAL IZQUIERDA Y DERECHA	7332	

BASES PARA AMORTIGUADOR STRUT MOUNTS



7332



CONTINUACIÓN... ROUTAN

28		APLICACIÓN / DESCRIPTION	DAI PARTS #
MISCELÁNEOS / AUTOMOTIVE RUBBER PARTS			
09-15		BUJE PARA HORQUILLA INFERIOR CHICO	DAI-1406048
		BUJE PARA HORQUILLA INFERIOR GRANDE	DAI-1406055
		TORNILLO ESTABILIZADOR FRONTAL	DAI-2106017

**MISCELÁNEOS
AUTOMOTIVE RUBBER PARTS**

DAI-1406048

DAI-1406055

DAI-2106017
SAFARI

SOPORTES / TRANSMISSION & MOTOR MOUNTS			
4 Hop 1500	53-73	SOPORTE PARA MOTOR IZQ. Y DER.	1715
		SOPORTE PARA TRANSMISIÓN	1924

**SOPORTES
TRANSMISSION & MOTOR MOUNTS**

1715

1924

MISCELÁNEOS / AUTOMOTIVE RUBBER PARTS			
53-73		COPLÉ PARA DIRECCIÓN (SINFÍN DE .637" NO REQUIERE PERNOS)	609
		GALLETA PARA DIRECCIÓN STD. Y HID. (NO REQUIERE PERNOS COMPLETO 609)	623

**MISCELÁNEOS
AUTOMOTIVE RUBBER PARTS**

609

623

SAVEIRO

  28		APLICACIÓN / DESCRIPTION	DAI PARTS #
SOPORTES / TRANSMISSION & MOTOR MOUNTS			
L4 1.8	09-16	SOPORTE PARA MOTOR TRASERO	7058
		SOPORTE PARA TRANSMISIÓN	7380
		SOPORTE PARA MOTOR DERECHO	7393



 28		APLICACIÓN / DESCRIPTION	DAI PARTS #	DAI KIT PARTS #
BASES PARA AMORTIGUADOR / STRUT MOUNTS				
09-13	BASE PARA AMORTIGUADOR FRONTAL IZQUIERDA Y DERECHA		1815	1815-KIT
	BASE PARA AMORTIGUADOR FRONTAL IZQUIERDA Y DERECHA		1816	6759-KIT
	BALERO PARA BASE DE AMORTIGUADOR (1815)		6119	



CONTINUACIÓN... SAVEIRO

		APLICACIÓN / DESCRIPTION	DAI PARTS #
CUBRE POLVOS / C.V. BOOTS			
09-16		CUBRE POLVO IZQUIERDO Y DERECHO LADO RUEDA	63147
		CUBRE POLVO IZQUIERDO Y DERECHO LADO CAJA	63148
		CUBRE POLVO IZQUIERDO Y DERECHO DE DIRECCIÓN	63149

MISCELÁNEOS / AUTOMOTIVE RUBBER PARTS

09-16		TOPE PARA AMORTIGUADOR FRONTAL IZQUIERDO Y DERECHO	D-015
		TOPE PARA AMORTIGUADOR TRASERO IZQUIERDO Y DERECHO	D-050
		TOPE PARA AMORTIGUADOR TRASERO IZQUIERDO Y DERECHO	D-071
		BUJES PARA HORQUILLA INFERIOR CHICO Y GRANDE (POLIURETANO KIT)	9800
		BUJES PARA HORQUILLA INFERIOR (POLIURETANO KIT CON CASQUILLO)	9809
		BUJE PARA HORQUILLA INFERIOR GRANDE (CON CEJA BUJE INTERNO CHICO)	64650
		BUJE PARA HORQUILLA INFERIOR GRANDE (CON CEJA BUJE INTERNO GRANDE)	64651
		BUJE PARA HORQUILLA INFERIOR GRANDE (SIN CEJA BUJE INTERNO GRANDE)	64760
		BUJE PARA HORQUILLA CHICO	DAI-191-407-182

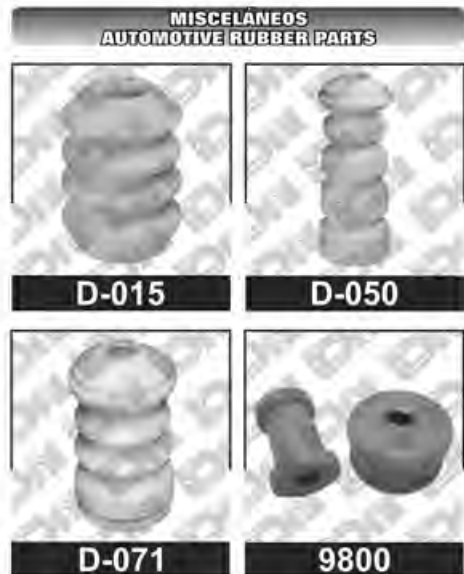

SCIROCCO

28		APLICACIÓN / DESCRIPTION	DAI PARTS #	DAI KIT PARTS #
BASES PARA AMORTIGUADOR / STRUT MOUNTS				
75-88		BASE AMORTIGUADOR FRONTAL IZQUIERDA Y DERECHA	1890	1890-KIT
		BALERO PARA BASE DE AMORTIGUADOR 1808, 1852, 1886, 7055, 7103 Y 1890	6137	

**BASES PARA AMORTIGUADOR
STRUT MOUNTS**



1890



1890-KIT



SEDAN

28		APLICACIÓN / DESCRIPTION	DAI PARTS #
SOPORTES / TRANSMISSION & MOTOR MOUNTS			
4 Hop 1500	53-73	SOPORTE PARA MOTOR IZQUIERDO Y DERECHO	1715
		SOPORTE PARA TRANSMISIÓN	1924
4 Hop 1600 1600I	74-04	SOPORTE PARA MOTOR IZQUIERDO Y DERECHO	1715
		SOPORTE PARA TRANSMISIÓN	1805

**SOPORTES
TRANSMISSION & MOTOR MOUNTS**



1715



1805



CONTINUACIÓN... SEDAN

28		APLICACIÓN / DESCRIPTION	DAI PARTS #
CUBRE POLVOS / C.V. BOOTS			
53-04	CUBRE POLVO IZQUIERDO Y DERECHO LADO CAJA (ABRAZADERA SIN FIN)	6307	
	CUBRE POLVO IZQUIERDO Y DERECHO LADO CAJA (ABRAZADERA DE SEGURIDAD)	6317	



MISCELÁNEOS / AUTOMOTIVE RUBBER PARTS		
53-04	GOMA TRASERA PARA CASETA	109
	COPLE PARA DIRECCIÓN (SINFÍN DE .637 mm NO REQUIERE PERNOS)	609
	GALLETAS PARA DIRECCIÓN STD. Y HID. (NO REQUIERE PERNOS COMPLETO 609)	623
	GOMA PARA BARRA ESTABILIZADORA	6041
	GOMA PARA MULTIPLE DE ADMISION	6544
	GOMA PARA MULTIPLE DE ADMISION (ABIERTA)	6547
	GOMA PARA SUSPENSIÓN	FP01
	GOMA PARA SUSPENSIÓN	FP02
	GOMA PARA SUSPENSIÓN	FP03
	GOMA PARA SUSPENSIÓN	FP04
CUBRE POLVO PARA PALANCA DE FRENO	6552	

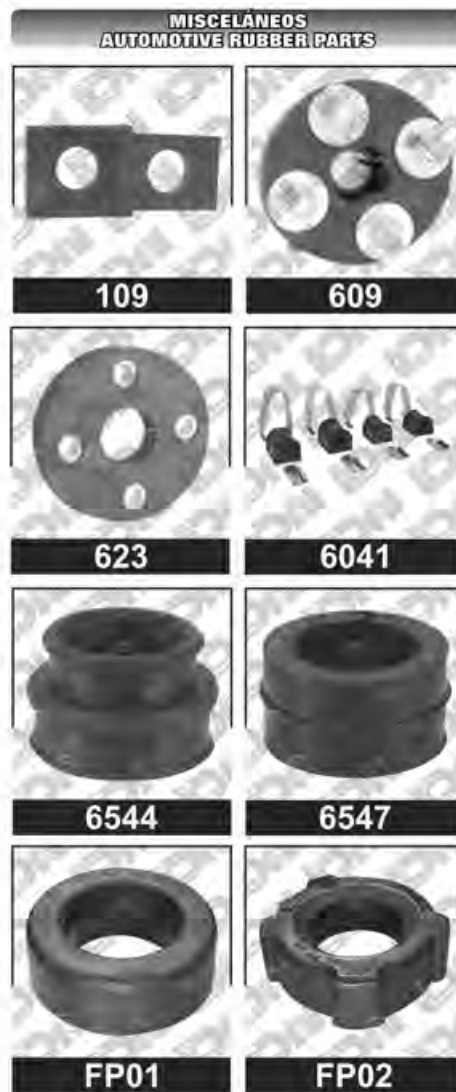

SHARAN

		28	APLICACIÓN / DESCRIPTION	DAI PARTS #
SOPORTES / TRANSMISSION & MOTOR MOUNTS				
L4 1.8	02-08		SOPORTE PARA MOTOR DERECHO	7576
	03-08		REPUESTO PARA SOPORTE DE MOTOR TRASERO	7549-9



CUBRE POLVOS / C.V. BOOTS

	02-08	CUBRE POLVO IZQUIERDO Y DERECHO LADO CAJA (CON TRIPOIDE)	63116
		CUBRE POLVO IZQUIERDO Y DERECHO LADO RUEDA	63184
		CUBRE POLVO IZQUIERDO Y DERECHO LADO CAJA (CON TRIPOIDE)	63185
		CUBRE POLVO IZQUIERDO Y DERECHO DE DIRECCIÓN	63186



MISCELÁNEOS / AUTOMOTIVE RUBBER PARTS

	02-08	TOPE PARA AMORTIGUADOR FRONTAL IZQUIERDO Y DERECHO	D-074
		TORNILLO ESTABILIZADOR FRONTAL	DAI-2126003





SPORT VAN

 		APLICACIÓN / DESCRIPTION	DAI PARTS #
SOPORTES / TRANSMISSION & MOTOR MOUNTS			
L4 1.6	07-10	SOPORTE PARA MOTOR DERECHO	7057-H
		SOPORTE PARA MOTOR TRASERO	7058
		SOPORTE PARA TRANSMISIÓN	7060





 		APLICACIÓN / DESCRIPTION	DAI PARTS #	DAI KIT PARTS #
BASES PARA AMORTIGUADOR / STRUT MOUNTS				
03-07		BASE PARA AMORTIGUADOR TRASERA IZQUIERDA Y DERECHA	6906	
		BASE PARA AMORTIGUADOR FRONTAL IZQUIERDA Y DERECHA	7214	7214-KIT
		BALERO PARA BASE DE AMORTIGUADOR FRONTAL IZQUIERDO Y DERECHO (7214)	6145	



 		APLICACIÓN / DESCRIPTION	DAI PARTS #
CUBRE POLVOS / C.V. BOOTS			
	07-10	CUBRE POLVO IZQUIERDO Y DERECHO LADO RUEDA	63147
		CUBRE POLVO IZQUIERDO Y DERECHO LADO CAJA	63148



CONTINUACIÓN... SPORT VAN

	 28	APLICACIÓN / DESCRIPTION	DAI PARTS #
CUBRE POLVOS / C.V. BOOTS			
	07-10	CUBRE POLVO IZQUIERDO Y DERECHO DE DIRECCIÓN	63149



MISCELÁNEOS / AUTOMOTIVE RUBBER PARTS

03-07	BUJE INFERIOR GRANDE	64812
	BUJE PARA HORQUILLA INFERIOR CHICO	DAI-1426003
	BUJE PARA EJE TRASERO IZQUIERDO Y DERECHO	DAI-1426037
	TORNILLO ESTABILIZADOR FRONTAL	DAI-2126004
	BUJE PARA EJE TRASERO	DAI-1J0-501-541



TIGUAN

SOPORTES / TRANSMISSION & MOTOR MOUNTS

L4 2.0	09-15	SOPORTE PARA MOTOR TRASERO SUPERIOR (CON CUERDA)	7194
		SOPORTE PARA MOTOR TRASERO INFERIOR (SIN CUERDA)	7195



CONTINUACIÓN... TIGUAN

 28		APLICACIÓN / DESCRIPTION	DAI PARTS #
SOPORTES / TRANSMISSION & MOTOR MOUNTS			
L4 2.0	09-15	SOPORTE PARA MOTOR DERECHO	7453-H
	12-16	SOPORTE PARA TRANSMISIÓN AUT.	7211
		SOPORTE PARA TRANSMISIÓN STD. Y AUT.	7212
		SOPORTE PARA MOTOR TRASERO	7254



 28		APLICACIÓN / DESCRIPTION	DAI PARTS #	DAI KIT PARTS #
BASES PARA AMORTIGUADOR / STRUT MOUNTS				
09-15		BALERO PARA BASE DE AMORTIGUADOR FRONTAL IZQUIERDO Y DERECHO (7214)	6145	



 28		APLICACIÓN / DESCRIPTION	DAI PARTS #
MISCELÁNEOS / AUTOMOTIVE RUBBER PARTS			
	09-15	TORNILLO ESTABILIZADOR FRONTAL	DAI-2126010
	09-17	BUJE PARA HORQUILLA INFERIOR CHICO	DAI-1426011



TRANSPORTER

  28		APLICACIÓN / DESCRIPTION	DAI PARTS #
SOPORTES / TRANSMISSION & MOTOR MOUNTS			
L4 1.9	11-15	SOPORTE PARA MOTOR FRONTAL	7139
		SOPORTE PARA TRANSMISIÓN	7143
		SOPORTE PARA MOTOR TRASERO	7145
		SOPORTE PARA MOTOR DERECHO (TDI)	7467-H

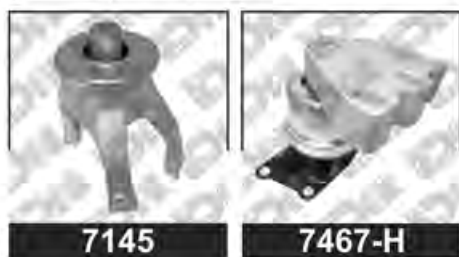

MISCELÁNEOS / AUTOMOTIVE RUBBER PARTS

	01-04	BUJE SUPERIOR CHICO	DAI-1426006
		BUJE SUPERIOR GRANDE	DAI-1426005
	05-10	TORNILLO ESTABILIZADOR FRONTAL	DAI-2126013
	10-15	BUJE PARA CHASIS Ó BASTIDOR	7449



VARIOS

MISCELÁNEOS / AUTOMOTIVE RUBBER PARTS

	TOPE PARA SUSPENSIÓN TRASERA	6122
	TOPE PARA SUSPENSIÓN DELANTERA (DAIM. EXT. .62 mm DIAM. INT. .25 mm ALT. .52 mm)	6123





VENTO

 		APLICACIÓN / DESCRIPTION	DAI PARTS #
SOPORTES / TRANSMISSION & MOTOR MOUNTS			
L4 1.6	14-18	SOPORTE PARA TRANSMISIÓN	7770
		SOPORTE PARA MOTOR TRASERO TORQUE STRUT	7773



		APLICACIÓN / DESCRIPTION	DAI PARTS #	DAI KIT PARTS #
BASES PARA AMORTIGUADOR / STRUT MOUNTS				
14-18	BASE PARA AMORTIGUADOR FRONTAL IZQUIERDA Y DERECHA		1815	1815-KIT
	BALERO PARA BASE DE AMORTIGUADOR 1815 Y 6759		6119	



 		APLICACIÓN / DESCRIPTION	DAI PARTS #
CUBRE POLVOS / C.V. BOOTS			
	14-16	CUBRE POLVO IZQUIERDO Y DERECHO LADO RUEDA	63187
		CUBRE POLVO IZQUIERDO Y DERECHO DE DIRECCIÓN	63188



CONTINUACIÓN... VENTO

 		APLICACIÓN / DESCRIPTION	DAI PARTS #
MISCELÁNEOS / AUTOMOTIVE RUBBER PARTS			
14-16		BUJES PARA HORQUILLA INFERIOR (POLIURETANO KIT)	9800
		BUJES PARA HORQUILLA INFERIOR (POLIURETANO KIT CON CASQUILLO)	9809
		BUJE PARA HORQUILLA INFERIOR GRANDE (CON CEJA BUJE INTERNO CHICO)	64650
		BUJE PARA EJE TRASERO	DAI-1426037
		TORNILLO ESTABILIZADOR FRONTAL	DAI-2126004
		BUJE PARA HORQUILLA CHICO	DAI-191-407-182
		BUJE PARA EJE TRASERO	DAI-1J0-501-541

**MISCELÁNEOS
AUTOMOTIVE RUBBER PARTS**



9800



9809



64650



DAI-1426037



DAI-2126004



DAI-191-407-182



DAI-1J0-501-541







A large sheet of white paper with horizontal ruling lines, resembling a notepad or a form for notes. The paper has a slightly distressed, torn-edge appearance at the bottom.



VOLVO



C-30

 		APLICACIÓN / DESCRIPTION	DAI PARTS #
SOPORTES / TRANSMISSION & MOTOR MOUNTS			
L5 2.5	08-13	SOPORTE PARA MOTOR TRASERO	7617
		SOPORTE PARA MOTOR TRASERO REFORZADO	7759





	APLICACIÓN / DESCRIPTION	DAI PARTS #	DAI KIT PARTS #
BASES PARA AMORTIGUADOR / STRUT MOUNTS			
93-97	COMPLEMENTO PARA BASE DE AMORTIGUADOR FRONTAL IZQ. Y DER.	7627-9	
07-10	BASE PARA AMORTIGUADOR FRONTAL IZQUIERDA Y DERECHA	7182	



 		APLICACIÓN / DESCRIPTION	DAI PARTS #
MISCELÁNEOS / AUTOMOTIVE RUBBER PARTS			
	07-10	TORNILLO ESTABILIZADOR FRONTAL	DAI-2113001
		BUJE PARA HORQUILLA INFERIOR GRANDE	DAI-1408057



S-40

 		APLICACIÓN / DESCRIPTION	DAI PARTS #
SOPORTES / TRANSMISSION & MOTOR MOUNTS			
L5 2.5	08-11	SOPORTE PARA MOTOR TRASERO	7617
		SOPORTE PARA MOTOR TRASERO REFORZADO	7759



CONTINUACIÓN... S-40

31	APLICACIÓN / DESCRIPTION	DAI PARTS #	DAI KIT PARTS #
BASES PARA AMORTIGUADOR / STRUT MOUNTS			
04-11	BASE PARA AMORTIGUADOR FRONTAL IZQUIERDA Y DERECHA	7182	

**BASES PARA AMORTIGUADOR
STRUT MOUNTS**

7182

31	APLICACIÓN / DESCRIPTION	DAI PARTS #
MISCELÁNEOS / AUTOMOTIVE RUBBER PARTS		
04-10	BUJE PARA HORQUILLA INFERIOR GRANDE	DAI-1408057
	TORNILLO ESTABILIZADOR FRONTAL	DAI-2113001

**MISCELÁNEOS
AUTOMOTIVE RUBBER PARTS**

DAI-1408057

DAI-2113001
S-60

28	APLICACIÓN / DESCRIPTION	DAI PARTS #	
SOPORTES / TRANSMISSION & MOTOR MOUNTS			
L5 2.3	04-09	SOPORTE PARA MOTOR FRONTAL INFERIOR	7629
L5 2.4	05-09	SOPORTE PARA MOTOR TRASERO SUPERIOR	7438
L5 2.5	05-09	SOPORTE PARA MOTOR TRASERO SUPERIOR	7438
		SOPORTE PARA MOTOR FRONTAL INFERIOR	7629

**SOPORTES
TRANSMISSION & MOTOR MOUNTS**

7438

7629

31	APLICACIÓN / DESCRIPTION	DAI PARTS #	DAI KIT PARTS #
BASES PARA AMORTIGUADOR / STRUT MOUNTS			
01-09	ASIENTO PARA RESORTE DELANTERO IZQUIERDO Y DERECHO	7627-9	

**BASES PARA AMORTIGUADOR
STRUT MOUNTS**

7627-9

S-70

28		APLICACIÓN / DESCRIPTION	DAI PARTS #	DAI KIT PARTS #
BASES PARA AMORTIGUADOR / STRUT MOUNTS				
98-07		ASIENTO PARA RESORTE DELANTERO IZQUIERDO Y DERECHO	7627-9	



S-80

28		APLICACIÓN / DESCRIPTION	DAI PARTS #
SOPORTES / TRANSMISSION & MOTOR MOUNTS			
L5 2.5	04-06	SOPORTE PARA MOTOR FRONTAL INFERIOR	7629
		SOPORTE PARA MOTOR TRASERO SUPERIOR	7438
L5 2.9	04-06	SOPORTE PARA MOTOR TRASERO SUPERIOR	7438



28		APLICACIÓN / DESCRIPTION	DAI PARTS #	DAI KIT PARTS #
BASES PARA AMORTIGUADOR / STRUT MOUNTS				
99-07		ASIENTO PARA RESORTE DELANTERO IZQUIERDO Y DERECHO	7627-9	



V-50

28		APLICACIÓN / DESCRIPTION	DAI PARTS #
SOPORTES / TRANSMISSION & MOTOR MOUNTS			
L5 2.4	08-10	SOPORTE PARA MOTOR TRASERO TORQUE STRUT	7617
		SOPORTE PARA MOTOR TRASERO REFORZADO	7759



V-70

		28	APLICACIÓN / DESCRIPTION	DAI PARTS #
SOPORTES / TRANSMISSION & MOTOR MOUNTS				
L5 2.3	2004		SOPORTE PARA MOTOR FRONTAL INFERIOR	7629
L5 2.4	05-07		SOPORTE PARA MOTOR TRASERO SUPERIOR	7438
	04-09		SOPORTE PARA MOTOR FRONTAL INFERIOR	7629
L5 2.5	05-07		SOPORTE PARA MOTOR TRASERO SUPERIOR	7438
			SOPORTE PARA MOTOR FRONTAL INFERIOR	7629

**SOPORTES
TRANSMISSION & MOTOR MOUNTS**

7438

7629

	31	APLICACIÓN / DESCRIPTION	DAI PARTS #	DAI KIT PARTS #
BASES PARA AMORTIGUADOR / STRUT MOUNTS				
98-08		ASIENTO PARA RESORTE DELANTERO IZQUIERDO Y DERECHO	7627-9	

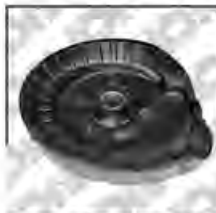
**BASES PARA AMORTIGUADOR
STRUT MOUNTS**

7627-9
XC-70

		28	APLICACIÓN / DESCRIPTION	DAI PARTS #
SOPORTES / TRANSMISSION & MOTOR MOUNTS				
L5 2.5	04-07		SOPORTE PARA MOTOR FRONTAL INFERIOR TORSIÓN	7629
	05-07		SOPORTE PARA MOTOR TRASERO SUPERIOR	7438

**SOPORTES
TRANSMISSION & MOTOR MOUNTS**

7438

7629
XC-90

		28	APLICACIÓN / DESCRIPTION	DAI PARTS #
SOPORTES / TRANSMISSION & MOTOR MOUNTS				
L5 2.5	04-06		SOPORTE PARA MOTOR FRONTAL INFERIOR TORSIÓN	7629

**SOPORTES
TRANSMISSION & MOTOR MOUNTS**

7629

BMW

GOMAS PARA SOPORTE DE FLECHA CARDÁN / SOPORTES COMPLETO DE FECHA CARDÁN

318i, 318is, 318it

 	APLICACIÓN / DESCRIPTION	DAI PARTS #
GOMAS PARA SOPORTES DE FLECHA CARDÁN / SOPORTES COMPLETOS DE FLECHA CARDÁN		
L4 1.9	92-98 SOPORTE PARA FLECHA CARDÁN (E36, E46 Y E39) OEM 26 12 226 731 y 26 12 1 2263 731S)	441

GOMAS Y SOPORTES PARA FLECHA CARDÁN



323is, 325i, 325is, 328i, 328is

GOMAS PARA SOPORTES DE FLECHA CARDÁN / SOPORTES COMPLETOS DE FLECHA CARDÁN		
L6 2.5	89-04 SOPORTE PARA FLECHA CARDÁN (E36, E46 Y E39) OEM 26 12 226 731 y 26 12 1 2263 731S)	441

GOMAS Y SOPORTES PARA FLECHA CARDÁN



525i, 528i, 530i

GOMAS PARA SOPORTES DE FLECHA CARDÁN / SOPORTES COMPLETOS DE FLECHA CARDÁN		
L6 2.5 L6 3.0	89-04 SOPORTE PARA FLECHA CARDÁN (E36, E46 Y E39) OEM 26 12 226 731 y 26 12 1 2263 731S)	441

GOMAS Y SOPORTES PARA FLECHA CARDÁN



Z3

28		APLICACIÓN / DESCRIPTION	DAI PARTS #
GOMAS PARA SOPORTES DE FLECHA CARDÁN / SOPORTES COMPLETOS DE FLECHA CARDÁN			
L4 1.9	96-98	SOPORTE PARA FLECHA CARDÁN (E36, E46 Y E39) OEM 26 12 226 731 y 26 12 1 2263 731S)	411
L6 2.5	99-02		
L6 2.8	97-00		
L6 3.0	01-02		
L6 3.2	98-02		

GOMAS Y SOPORTES PARA FLECHA CARDÁN

411
CHEVROLET
GOMAS PARA SOPORTE DE FLECHA CARDÁN / SOPORTES COMPLETO DE FECHA CARDÁN
AVALANCHE

28		APLICACIÓN / DESCRIPTION	DAI PARTS #
GOMAS PARA SOPORTES DE FLECHA CARDÁN / SOPORTES COMPLETOS DE FLECHA CARDÁN			
V8 5.3	07-14	SOPORTE PARA FLECHA CARDÁN	438
V8 6.0			

GOMAS Y SOPORTES PARA FLECHA CARDÁN

438
BLAZER



GOMAS PARA SOPORTES DE FLECHA CARDÁN / SOPORTES COMPLETOS DE FLECHA CARDÁN			
L4 1.9	82-84	GOMA PARA SOPORTE DE FLECHA CARDÁN 224, 414 Y DAI-416 (USA BALERO 88107)	207
L4 2.0	83-84		
L4 2.2	83-03	SOPORTE PARA FLECHA CARDÁN GOMAS 207, 230 (INCLUYE BALERO 88107)	224
L4 2.5	85-93		

GOMAS Y SOPORTES PARA FLECHA CARDÁN

207

224

CONTINUACIÓN... BLAZER

 		APLICACIÓN / DESCRIPTION	DAI PARTS #
GOMAS PARA SOPORTES DE FLECHA CARDÁN / SOPORTES COMPLETOS DE FLECHA CARDÁN			
L4 1.9 L4 2.0 L4 2.2 L4 2.5	82-84	GOMA PARA SOPORTE DE FLECHA CARDÁN 224, 414 Y DAI-416 (USA BALERO 88107)	230
	83-84	SOPORTE PARA FLECHA CARDÁN GOMAS 207, 230 (INCLUYE BALERO 88107)	414
	83-03	SOPORTE PARA FLECHA CARDÁN GOMAS 207, 230 (CON BALERO 88107)	DAI-416
	85-93	BALERO PARA SOPORTE DE FLECHA CARDÁN SOPORTE 224, 414, DAI-416 GOMAS 207 Y 230	88107
V6 2.8	82-93	GOMA PARA SOPORTE DE FLECHA CARDÁN 224, 414 Y DAI-416 (USA BALERO 88107)	230
		SOPORTE PARA FLECHA CARDÁN GOMAS 207, 230 (INCLUYE BALERO 88107)	414
		SOPORTE PARA FLECHA CARDÁN GOMAS 207, 230 (CON BALERO 88107)	DAI-416
		BALERO PARA SOPORTE DE FLECHA CARDÁN SOPORTE 224, 414, DAI-416 GOMAS 207 Y 230	88107
V6 4.3	88-95	GOMA PARA SOPORTE DE FLECHA CARDÁN 224, 414 Y DAI-416 (CON BALERO 88107)	207
		SOPORTE PARA FLECHA CARDÁN GOMAS 207, 230 (INCLUYE BALERO 88107)	224
		GOMA PARA SOPORTE DE FLECHA CARDÁN 224, 414 Y DAI-416 (USA BALERO 88107)	230
		SOPORTE PARA FLECHA CARDÁN GOMAS 207, 230 (INCLUYE BALERO 88107)	414
		SOPORTE PARA FLECHA CARDÁN GOMAS 207, 230 (CON BALERO 88107)	DAI-416
		BALERO PARA SOPORTE DE FLECHA CARDÁN SOPORTE 224, 414, DAI-416 GOMAS 207 Y 230	88107
V6 2.8	82-93	GOMA PARA SOPORTE DE FLECHA CARDÁN 224, 414 Y DAI-416 (USA BALERO 88107)	207
V6 4.3 V8 5.3	07-14 00-14	SOPORTE PARA FLECHA CARDÁN	438

GOMAS Y SOPORTES PARA FLECHA CARDÁN



C-15

	 28	APLICACIÓN / DESCRIPTION	DAI PARTS #
--	--	--------------------------	-------------

GOMAS Y SOPORTES PARA FLECHA CARDÁN
GOMAS PARA SOPORTES DE FLECHA CARDÁN / SOPORTES COMPLETOS DE FLECHA CARDÁN

L6 4.1 L6 4.8 V8 5.0 V8 5.7 V8 6.2 V8 8.1	55-05	GOMA PARA SOPORTE DE FLECHA CARDÁN 411 (USA BALERO 88509)	226
		SOPORTE PARA FLECHA CARDÁN GOMA 226 (INCLUYE BALERO 88509)	411
		GOMA PARA SOPORTE DE FLECHA CARDÁN EN POLIURETANO 9411 (USA BALERO 88508)	9226
		SOPORTE PARA FLECHA CARDÁN EN POLIURETANO GOMA 9226 (INCLUYE BALERO 88509)	9411
		GOMA PARA SOPORTE DE FLECHA CARDÁN 411 (USA BALERO 88509)	DAI-226
		SOPORTE PARA FLECHA CARDÁN GOMA 226 (INCLUYE BALERO 88509)	DAI-411
		BALERO PARA SOPORTE DE FLECHA CARDÁN SOPORTE 224, 414, DAI-416 GOMAS 207 Y 230	88107
		BALERO PARA SOPORTE DE FLECHA CARDÁN SOPORTE 411, 9411, DAI-411 GOMAS 226,9226 Y DAI-226	88509

DAI-226

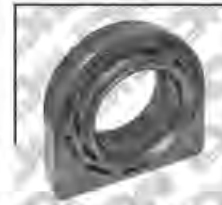
DAI-411

226

411

9226



9411

V8 6.5	55-05	SOPORTE PARA FLECHA CARDÁN GOMA 226 (INCLUYE BALERO 88509)	411
		GOMA PARA SOPORTE DE FLECHA CARDÁN EN POLIURETANO 9411 (USA BALERO 88508)	9226
		SOPORTE PARA FLECHA CARDÁN EN POLIURETANO GOMA 9226 (INCLUYE BALERO 88509)	9411
		GOMA PARA SOPORTE DE FLECHA CARDÁN 411 (USA BALERO 88509)	DAI-226
		SOPORTE PARA FLECHA CARDÁN GOMA 226 (BALERO 88509)	DAI-411
		BALERO PARA SOPORTE DE FLECHA CARDÁN SOPORTE 224, 414, DAI-416 GOMAS 207 Y 230	88107
		BALERO PARA SOPORTE DE FLECHA CARDÁN SOPORTE 411, 9411, DAI-411 GOMAS 226, 9226 Y DAI-226	88509

88107

88509

C-20

 		APLICACIÓN / DESCRIPTION	DAI PARTS #
GOMAS PARA SOPORTES DE FLECHA CARDÁN / SOPORTES COMPLETOS DE FLECHA CARDÁN			
L6 4.1 L6 4.8 V8 5.0 V8 5.7 V8 6.2 V8 6.5 V8 8.1	55-05	GOMA PARA SOPORTE DE FLECHA CARDÁN 411 (USA BALERO 88509)	226
		SOPORTE PARA FLECHA CARDÁN GOMA 226 (INCLUYE BALERO 88509)	411
		GOMA PARA SOPORTE DE FLECHA CARDÁN EN POLIURETANO 9411 (USA BALERO 88508)	9226
		SOPORTE PARA FLECHA CARDÁN EN POLIURETANO GOMA 9226 (INCLUYE BALERO 88509)	9411
		GOMA PARA SOPORTE DE FLECHA CARDÁN 411 (USA BALERO 88509)	DAI-226
		SOPORTE PARA FLECHA CARDÁN GOMA 226 (BALERO 88509)	DAI-411
		BALERO PARA SOPORTE DE FLECHA CARDÁN SOPORTE 224, 414, DAI-416 GOMAS 207 Y 230	88107
		BALERO PARA SOPORTE DE FLECHA CARDÁN SOPORTE 411, 9411, DAI-411 GOMAS 226, 9226 Y DAI-226	88509



C-1500

 		APLICACIÓN / DESCRIPTION	DAI PARTS #
GOMAS PARA SOPORTES DE FLECHA CARDÁN / SOPORTES COMPLETOS DE FLECHA CARDÁN			
L6 4.1 V8 5.0 V8 5.7 V8 6.2 V8 6.5 V8 8.1	55-05	GOMA PARA SOPORTE DE FLECHA CARDÁN 411 (USA BALERO 88509)	226
		SOPORTE PARA FLECHA CARDÁN GOMA 226 (INCLUYE BALERO 88509)	411



921

IMPORTANTE: Identifica nuestro producto con el grabado del logo  No aceptes imitaciones.



CONTINUACIÓN... C-1500

		APLICACIÓN / DESCRIPTION	DAI PARTS #
GOMAS PARA SOPORTES DE FLECHA CARDÁN / SOPORTES COMPLETOS DE FLECHA CARDÁN			
L6 4.1 V8 5.0 V8 5.7 V8 6.2 V8 6.5 V8 8.1	55-05	GOMA PARA SOPORTE DE FLECHA CARDÁN EN POLIURETANO 9411 (USA BALERO 88508)	9226
		SOPORTE PARA FLECHA CARDÁN EN POLIURETANO GOMA 9226 (INCLUYE BALERO 88509)	9411
		GOMA PARA SOPORTE DE FLECHA CARDÁN 411 (USA BALERO 88509)	DAI-226
		SOPORTE PARA FLECHA CARDÁN GOMA 226 (INCLUYE BALERO 88509)	DAI-411
		BALERO PARA SOPORTE DE FLECHA CARDÁN SOPORTES 224, 414, DAI-416 GOMAS 207 Y 230	88107
		BALERO PARA SOPORTE DE FLECHA CARDÁN SOPORTES 411, 9411, DAI-411 GOMAS 226, 9226 Y DAI-226	88509

C-2500

		APLICACIÓN / DESCRIPTION	DAI PARTS #
GOMAS PARA SOPORTES DE FLECHA CARDÁN / SOPORTES COMPLETOS DE FLECHA CARDÁN			
L6 4.1 L6 4.8 V8 5.0 V8 5.7 V8 6.2 V8 6.5 V8 8.1	55-05	GOMA PARA SOPORTE DE FLECHA CARDÁN 411 (USA BALERO 88509)	226
		SOPORTE PARA FLECHA CARDÁN GOMA 226 (INCLUYE BALERO 88509)	411

922
IMPORTANTE: Identifica nuestro producto con el grabado del logo No aceptes imitaciones.

CONTINUACIÓN... C-2500

 		APLICACIÓN / DESCRIPTION	DAI PARTS #
GOMAS PARA SOPORTES DE FLECHA CARDÁN / SOPORTES COMPLETOS DE FLECHA CARDÁN			
L6 4.1 L6 4.8 V8 5.0 V8 5.7 V8 6.2 V8 6.5 V8 8.1	55-05	GOMA PARA SOPORTE DE FLECHA CARDÁN EN POLIURETANO 9411 (USA BALERO 88508)	9226
		SOPORTE PARA FLECHA CARDÁN EN POLIURETANO GOMA 9226 (INCLUYE BALERO 88509)	9411
		GOMA PARA SOPORTE DE FLECHA CARDÁN 411 (USA BALERO 88509)	DAI-226
		SOPORTE PARA FLECHA CARDÁN GOMA 226 (INCLUYE BALERO 88509)	DAI-411
		BALERO PARA SOPORTE DE FLECHA CARDÁN SOPORTES 224, 414, DAI-416 GOMAS 207 Y 230	88107
		BALERO PARA SOPORTE DE FLECHA CARDÁN SOPORTES 411, 9411, DAI-411 GOMAS 226, 9226 Y DAI-226	88509



C-3500

GOMAS PARA SOPORTES DE FLECHA CARDÁN / SOPORTES COMPLETOS DE FLECHA CARDÁN			
L6 4.1 L6 4.8 V8 5.0 V8 6.2 V8 6.5 V8 8.1 V8 5.7	55-05	GOMA PARA SOPORTE DE FLECHA CARDÁN 411 (USA BALERO 88509)	226
		SOPORTE PARA FLECHA CARDÁN GOMA 226 (INCLUYE BALERO 88509)	411
		GOMA PARA SOPORTE DE FLECHA CARDÁN EN POLIURETANO 9411 (USA BALERO 88508)	9226



CONTINUACIÓN... C-3500

  28		APLICACIÓN / DESCRIPTION	DAI PARTS #
GOMAS PARA SOPORTES DE FLECHA CARDÁN / SOPORTES COMPLETOS DE FLECHA CARDÁN			
L6 4.1 L6 4.8 V8 5.0 V8 6.2 V8 6.5 V8 8.1 V8 5.7	55-05	SOPORTE PARA FLECHA CARDÁN EN POLIURETANO GOMA 9226 (INCLUYE BALERO 88509)	9411
		GOMA PARA SOPORTE DE FLECHA CARDÁN 411 (USA BALERO 88509)	DAI-226
		SOPORTE PARA FLECHA CARDÁN GOMA 226 (INCLUYE BALERO 88509)	DAI-411
		BALERO PARA SOPORTE DE FLECHA CARDÁN SOPORTES 224, 414, DAI-416 GOMAS 207 Y 230	88107
		BALERO PARA SOPORTE DE FLECHA CARDÁN SOPORTES 411, 9411, DAI-411 GOMAS 226, 9226 Y DAI-226	88509

C-4500

GOMAS PARA SOPORTES DE FLECHA CARDÁN / SOPORTES COMPLETOS DE FLECHA CARDÁN			
V8 8.1	02-05	GOMA PARA SOPORTE DE FLECHA CARDÁN 411 (USA BALERO 88509)	226
		SOPORTE PARA FLECHA CARDÁN GOMA 226 (INCLUYE BALERO 88509)	411
		GOMA PARA SOPORTE DE FLECHA CARDÁN EN POLIURETANO 9411 (USA BALERO 88508)	9226



CONTINUACIÓN... C-4500

 		APLICACIÓN / DESCRIPTION	DAI PARTS #
GOMAS PARA SOPORTES DE FLECHA CARDÁN / SOPORTES COMPLETOS DE FLECHA CARDÁN			
V8 8.1	02-05	SOPORTE PARA FLECHA CARDÁN EN POLIURETANO GOMA 9226 (INCLUYE BALERO 88509)	9411
		GOMA PARA SOPORTE DE FLECHA CARDÁN 411 (USA BALERO 88509)	DAI-226
		SOPORTE PARA FLECHA CARDÁN GOMA 226 (INCLUYE BALERO 88509)	DAI-411
		BALERO PARA SOPORTE DE FLECHA CARDÁN SOPORTES 224, 414, DAI-416 GOMAS 207 Y 230	88107
		BALERO PARA SOPORTE DE FLECHA CARDÁN SOPORTES 411, 9411, DAI-411 GOMAS 226, 9226 Y DAI-226	88509



CANYON

GOMAS PARA SOPORTES DE FLECHA CARDÁN / SOPORTES COMPLETOS DE FLECHA CARDÁN			
L4 2.9	05-11	SOPORTE PARA FLECHA CARDÁN	7424
V6 3.7	05-12		



925

IMPORTANTE: Identifica nuestro producto con el grabado del logo  No aceptes imitaciones.



CHEYENNE

		APLICACIÓN / DESCRIPTION	DAI PARTS #
GOMAS PARA SOPORTES DE FLECHA CARDÁN / SOPORTES COMPLETOS DE FLECHA CARDÁN			
V6 4.3 V6 4.8 V6 5.3 V6 6.0 V8 6.2 V8 6.6	07-14	SOPORTE PARA FLECHA CARDÁN	438

GOMAS Y SOPORTES PARA FLECHA CARDÁN

438
COLORADO

GOMAS PARA SOPORTES DE FLECHA CARDÁN / SOPORTES COMPLETOS DE FLECHA CARDÁN			
L4 2.9 V6 3.7	05-11 05-12	SOPORTE PARA FLECHA CARDÁN	7424

GOMAS Y SOPORTES PARA FLECHA CARDÁN

7424
DENALI

GOMAS PARA SOPORTES DE FLECHA CARDÁN / SOPORTES COMPLETOS DE FLECHA CARDÁN			
V6 4.3 V8 6.0 V8 6.2 V8 4.8 V8 5.3	07-14	SOPORTE PARA FLECHA CARDÁN	438
V8 5.7 V8 6.5	92-98 94-99	GOMA PARA SOPORTE DE FLECHA CARDÁN DAI-219 (USA BALERO 88508)	209
		SOPORTE PARA FLECHA CARDÁN GOMA 209 (USA BALERO 88508) (INCLUYE BALERO 88509)	219
		GOMA PARA SOPORTE DE FLECHA CARDÁN EN POLIURETANO 9219 (USA BALERO 88508)	9209

GOMAS Y SOPORTES PARA FLECHA CARDÁN

209

219

438



9209

CONTINUACIÓN... DENALI

 		APLICACIÓN / DESCRIPTION	DAI PARTS #
GOMAS PARA SOPORTES DE FLECHA CARDÁN / SOPORTES COMPLETOS DE FLECHA CARDÁN			
V8 5.7 V8 6.5	92-98 94-99	SOPORTE PARA FLECHA CARDÁN EN POLIURETANO GOMA 9209 (INCLUYE BALERO 88508)	9219
		GOMA PARA SOPORTE DE FLECHA CARDÁN DAI-219 (USA BALERO 88508)	DAI-209
		SOPORTE PARA FLECHA CARDÁN GOMA 209 (INCLUYE BALERO 88508)	DAI-219
		BALERO PARA SOPORTE DE FLECHA CARDÁN SOPORTES 219, 9219, DAI-219, DAI-421 GOMAS 209, 9209, DAI-209 Y 225	88508



JIMMY

 		APLICACIÓN / DESCRIPTION	DAI PARTS #
GOMAS PARA SOPORTES DE FLECHA CARDÁN / SOPORTES COMPLETOS DE FLECHA CARDÁN			
L4 1.9 L4 2.0 L4 2.2 L4 2.5 V6 2.8 V6 4.3	82-94 83-84 83-03 85-93 82-93 88-95	GOMA PARA SOPORTE DE FLECHA CARDÁN 224, 414 Y DAI-416 (USA BALERO 88107)	207
		SOPORTE PARA FLECHA CARDÁN GOMAS 207, 230 (INCLUYE BALERO 88107)	224
		GOMA PARA SOPORTE DE FLECHA CARDÁN 224, 414 Y DAI-416 (USA BALERO 88107)	230
		SOPORTE PARA FLECHA CARDÁN GOMAS 207, 230 (INCLUYE BALERO 88107)	414
		SOPORTE PARA FLECHA CARDÁN GOMAS 207, 230 (CON BALERO 88107)	DAI-416
		BALERO PARA SOPORTE DE FLECHA CARDÁN SOPORTES 224, 414, DAI-416 GOMAS 207 Y 230	88107
V6 4.3 V8 5.3	07-14 00-14	SOPORTE PARA FLECHA CARDÁN	438



JIMMY

 28		APLICACIÓN / DESCRIPTION	DAI PARTS #
GOMAS PARA SOPORTES DE FLECHA CARDÁN / SOPORTES COMPLETOS DE FLECHA CARDÁN			
L4 1.9 L4 2.0 L4 2.2 L4 2.5 V6 2.8	82-84	GOMA PARA SOPORTE DE FLECHA CARDÁN 224, 414 Y DAI-416 (USA BALERO 88107)	207
		SOPORTE PARA FLECHA CARDÁN GOMAS 207, 230 (USA BALERO 88107)	224
	83-84	GOMA PARA SOPORTE DE FLECHA CARDÁN 224, 414 Y DAI-416 (USA BALERO 88107)	230
	83-03	SOPORTE PARA FLECHA CARDÁN GOMAS 207, 230 (INCLUYE BALERO 88107)	414
	85-93	SOPORTE PARA FLECHA CARDÁN GOMAS 207, 230 (CON BALERO 88107)	DAI-416
	82-93	BALERO PARA SOPORTE DE FLECHA CARDÁN SOPORTES 224, 414, DAI-416 GOMAS 207 Y 230	88107
V6 4.3 V8 5.3	07-14 00-14	SOPORTE PARA FLECHA CARDÁN	438

GOMAS Y SOPORTES PARA FLECHA CARDÁN

DAI-416

207

224

230

414

438

88107
S-10, S-15

GOMAS PARA SOPORTES DE FLECHA CARDÁN / SOPORTES COMPLETOS DE FLECHA CARDÁN			
L4 1.9 L4 2.0 L4 2.2 L4 2.5 V6 2.8 V6 4.3	82-84	GOMA PARA SOPORTE DE FLECHA CARDÁN 224, 414 Y DAI-416 (USA BALERO 88107)	207
	83-84		
	83-03	SOPORTE PARA FLECHA CARDÁN GOMAS 207, 230 (USA BALERO 88107)	224
	85-93		
	82-93		

GOMAS Y SOPORTES PARA FLECHA CARDÁN

207

224

CONTINUACIÓN... S15

 		APLICACIÓN / DESCRIPTION	DAI PARTS #
GOMAS PARA SOPORTES DE FLECHA CARDÁN / SOPORTES COMPLETOS DE FLECHA CARDÁN			
L4 1.9	82-84	GOMA PARA SOPORTE DE FLECHA CARDÁN 224, 414 Y DAI-416 (USA BALERO 88107)	230
L4 2.0		SOPORTE PARA FLECHA CARDÁN GOMAS 207, 230 (INCLUYE BALERO 88107)	414
L4 2.2	83-84	SOPORTE PARA FLECHA CARDÁN GOMAS 207, 230 (CON BALERO 88107)	DAI-416
L4 2.5	83-03		
V6 2.8	85-93	BALERO PARA SOPORTE DE FLECHA CARDÁN SOPORTES 224, 414, DAI-416 GOMAS 207 Y 230	88107
V6 4.3	82-93		
V6 4.3	07-14	SOPORTE PARA FLECHA CARDÁN	438
V8 5.3	00-14		



SIERRA

GOMAS PARA SOPORTES DE FLECHA CARDÁN / SOPORTES COMPLETOS DE FLECHA CARDÁN			
V6 4.3	99-14	SOPORTE PARA FLECHA CARDÁN (1500)	438
V8 4.8	99-14	SOPORTE PARA FLECHA CARDÁN 1500, 2500 Y 3500	438
V8 5.3			
V8 6.0			
V8 6.2	07-14	SOPORTE PARA FLECHA CARDÁN 1500, 2500 Y 3500	438
V8 6.6			



SILVERADO

 		APLICACIÓN / DESCRIPTION	DAI PARTS #
GOMAS PARA SOPORTES DE FLECHA CARDÁN / SOPORTES COMPLETOS DE FLECHA CARDÁN			
V6 4.3	99-14	SOPORTE PARA FLECHA CARDÁN (1500)	438
V8 4.8 V8 5.3 V8 6.0	99-14	SOPORTE PARA FLECHA CARDÁN 1500, 2500 Y 3500	438
V8 6.2	07-14	SOPORTE PARA FLECHA CARDÁN 1500, 2500 Y 3500	438

GOMAS Y SOPORTES PARA FLECHA CARDÁN

438
SONORA

GOMAS PARA SOPORTES DE FLECHA CARDÁN / SOPORTES COMPLETOS DE FLECHA CARDÁN			
V6 4.3 V8 4.8 V8 5.3 V8 6.0 V8 6.2	07-14	SOPORTE PARA FLECHA CARDÁN (MEX.)	438
V8 5.7	92-98	GOMA PARA SOPORTE DE FLECHA CARDÁN DAI-219 (USA BALERO 88508)	209
		SOPORTE PARA FLECHA CARDÁN GOMA 209 (INCLUYE BALERO 88508)	219
		GOMA PARA SOPORTE DE FLECHA CARDÁN EN POLIURETANO 9219 (USA BALERO 88508)	9209
		SOPORTE PARA FLECHA CARDÁN EN POLIURETANO GOMA 9209 (INCLUYE BALERO 88508)	9219
		GOMA PARA SOPORTE DE FLECHA CARDÁN DAI-219 (USA BALERO 88508)	DAI-209
		SOPORTE PARA FLECHA CARDÁN GOMA 209 (INCLUYE BALERO 88508)	DAI-219

GOMAS Y SOPORTES PARA FLECHA CARDÁN

DAI-209

DAI-219

209

219

438

9209

9219

CONTINUACIÓN... SONORA

		APLICACIÓN / DESCRIPTION	DAI PARTS #
GOMAS PARA SOPORTES DE FLECHA CARDÁN / SOPORTES COMPLETOS DE FLECHA CARDÁN			
V8 5.7	92-98	BALERO PARA SOPORTE DE FLECHA CARDÁN SOPORTES 219, 9219, DAI-219, DAI-421 GOMAS 209, 9209, DAI-209 Y 225	88508

GOMAS Y SOPORTES PARA FLECHA CARDÁN



88508

SUBURBAN

GOMAS PARA SOPORTES DE FLECHA CARDÁN / SOPORTES COMPLETOS DE FLECHA CARDÁN			
V6 4.3 V8 4.8 V8 5.3 V8 6.0 V8 6.2	07-14	SOPORTE PARA FLECHA CARDÁN	438
V8 5.0 V8 5.7	68-99 92-99	GOMA PARA SOPORTE DE FLECHA CARDÁN DAI-219 (USA BALERO 88508)	209
		SOPORTE PARA FLECHA CARDÁN GOMA 209 (INCLUYE BALERO 88508)	219
		GOMA PARA SOPORTE DE FLECHA CARDÁN EN POLIURETANO 9219 (USA BALERO 88508)	9209
		SOPORTE PARA FLECHA CARDÁN EN POLIURETANO GOMA 9209 (INCLUYE BALERO 88508)	9219
		GOMA PARA SOPORTE DE FLECHA CARDÁN DAI-219 (USA BALERO 88508)	DAI-209
		SOPORTE PARA FLECHA CARDÁN GOMA 209 (INCLUYE BALERO 88508)	DAI-219
V8 5.0 V8 5.7	68-99 92-99	BALERO PARA SOPORTE DE FLECHA CARDÁN SOPORTES 219, 9219, DAI-219, DAI-421 GOMAS 209, 9209, DAI-209 Y 225	88508

GOMAS Y SOPORTES PARA FLECHA CARDÁN



DAI-209



DAI-219



209



219



438



9209



9219



88508



TAHOE

	28	APLICACIÓN / DESCRIPTION	DAI PARTS #
GOMAS PARA SOPORTES DE FLECHA CARDÁN / SOPORTES COMPLETOS DE FLECHA CARDÁN			
V8 4.8 V8 5.3 V8 6.0 V8 6.2	07-14	SOPORTE PARA FLECHA CARDÁN	438

V8 5.7 V8 6.5	92-98 94-99	GOMA PARA SOPORTE DE FLECHA CARDÁN DAI-219 (USA BALERO 88508)	209
		SOPORTE PARA FLECHA CARDÁN GOMA 209 (INCLUYE BALERO 88508)	219
		GOMA PARA SOPORTE DE FLECHA CARDÁN EN POLIURETANO 9219 (USA BALERO 88508)	9209
		SOPORTE PARA FLECHA CARDÁN EN POLIURETANO GOMA 9209 (INCLUYE BALERO 88508)	9219
		GOMA PARA SOPORTE DE FLECHA CARDÁN DAI-219 (USA BALERO 88508)	DAI-209
		SOPORTE PARA FLECHA CARDÁN GOMA 209 (INCLUYE BALERO 88508)	DAI-219
		BALERO PARA SOPORTE DE FLECHA CARDÁN SOPORTES 219, 9219, DAI-219, DAI-421 GOMAS 209, 9209, DAI-209 Y 225	88508

GOMAS Y SOPORTES PARA FLECHA CARDÁN

DAI-209

DAI-219

209

219

438

9209

9219

88508
YUKON

GOMAS PARA SOPORTES DE FLECHA CARDÁN / SOPORTES COMPLETOS DE FLECHA CARDÁN			
V6 4.3 V8 5.3 V8 4.8 V8 6.0 V8 6.2	07-14	SOPORTE PARA FLECHA CARDÁN	438

GOMAS Y SOPORTES PARA FLECHA CARDÁN

438



CONTINUACIÓN... YUKON

 		APLICACIÓN / DESCRIPTION	DAI PARTS #
GOMAS PARA SOPORTES DE FLECHA CARDÁN / SOPORTES COMPLETOS DE FLECHA CARDÁN			
V8 5.7 V8 6.5	92-98 94-99	GOMA PARA SOPORTE DE FLECHA CARDÁN DAI-219 (USA BALERO 88508)	209
		SOPORTE PARA FLECHA CARDÁN GOMA 209 (INCLUYE BALERO 88508)	219
		GOMA PARA SOPORTE DE FLECHA CARDÁN EN POLIURETANO 9219 (USA BALERO 88508)	9209
		SOPORTE PARA FLECHA CARDÁN EN POLIURETANO GOMA 9209 (INCLUYE BALERO 88508)	9219
		GOMA PARA SOPORTE DE FLECHA CARDÁN DAI-219 (USA BALERO 88508)	DAI-209
		SOPORTE PARA FLECHA CARDÁN GOMA 209 (INCLUYE BALERO 88508)	DAI-219
		BALERO PARA SOPORTE DE FLECHA CARDÁN SOPORTES 219, 9219, DAI-219, DAI-421 GOMAS 209, 9209, DAI-209 Y 225	88508

GOMAS Y SOPORTES PARA FLECHA CARDÁN



933

IMPORTANTE: Identifica nuestro producto con el grabado del logo  No aceptes imitaciones.



DODGE / CHRYSLER
GOMAS PARA SOPORTE DE FLECHA CARDÁN / SOPORTES COMPLETO DE FECHA CARDÁN
D-150

  28		APLICACIÓN / DESCRIPTION	DAI PARTS #
GOMAS PARA SOPORTES DE FLECHA CARDÁN / SOPORTES COMPLETOS DE FLECHA CARDÁN			
L6 3.7 L6 4.0 V6 3.9 V8 5.2 V8 5.7	75-94	GOMA PARA SOPORTE DE FLECHA CARDÁN DAI-219 (USA BALERO 88508)	209
		SOPORTE PARA FLECHA CARDÁN GOMA 209 (INCLUYE BALERO 88508)	219
		GOMA PARA SOPORTE DE FLECHA CARDÁN 411 (USA BALERO 88509)	226
		SOPORTE PARA FLECHA CARDÁN GOMA 226 (INCLUYE BALERO 88509)	411
		GOMA PARA SOPORTE DE FLECHA CARDÁN EN POLIURETANO 9219 (USA BALERO 88508)	9209
		SOPORTE PARA FLECHA CARDÁN EN POLIURETANO GOMA 9209 (INCLUYE BALERO 88508)	9219
		GOMA PARA SOPORTE DE FLECHA CARDÁN EN POLIURETANO 9411 (USA BALERO 88508)	9226
		SOPORTE PARA FLECHA CARDÁN EN POLIURETANO GOMA 9226 (INCLUYE BALERO 88509)	9411
		GOMA PARA SOPORTE DE FLECHA CARDÁN DAI-219 (USA BALERO 88508)	DAI-209
		SOPORTE PARA FLECHA CARDÁN GOMA 209 (INCLUYE BALERO 88508)	DAI-219
		GOMA PARA SOPORTE DE FLECHA CARDÁN 411 (USA BALERO 88509)	DAI-226
		SOPORTE PARA FLECHA CARDÁN GOMA 226 (INCLUYE BALERO 88509)	DAI-411

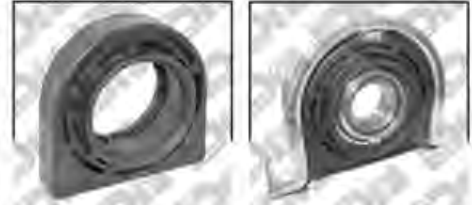
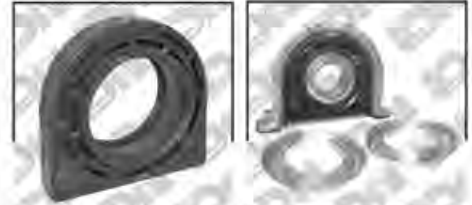
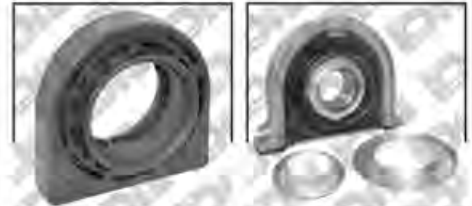
GOMAS Y SOPORTES PARA FLECHA CARDÁN

DAI-209
DAI-219

DAI-226
DAI-411

209
219

226
411

9209
9219
9226
9411

CONTINUACIÓN... D-150

		APLICACIÓN / DESCRIPTION	DAI PARTS #
GOMAS PARA SOPORTES DE FLECHA CARDÁN / SOPORTES COMPLETOS DE FLECHA CARDÁN			
L6 3.7 L6 4.0 V6 3.9 V8 5.2 V8 5.7	75-94	BALERO PARA SOPORTE DE FLECHA CARDÁN SOPORTES 224, 414, DAI-416 GOMAS 207 Y 230	88107
		BALERO PARA SOPORTE DE FLECHA CARDÁN SOPORTES 219, 9219, DAI-219, DAI-421 GOMAS 209, 9209, DAI-209 Y 225	88508
		BALERO PARA SOPORTE DE FLECHA CARDÁN SOPORTES 411, 9411, DAI-411 GOMAS 226, 9226 Y DAI-226	88509

GOMAS Y SOPORTES PARA FLECHA CARDÁN



D-200

		APLICACIÓN / DESCRIPTION	DAI PARTS #
GOMAS PARA SOPORTES DE FLECHA CARDÁN / SOPORTES COMPLETOS DE FLECHA CARDÁN			
L6 3.7 L6 4.0 V6 3.9 V8 5.2 V8 5.7	75-94	GOMA PARA SOPORTE DE FLECHA CARDÁN DAI-219 (USA BALERO 88508)	209
		SOPORTE PARA FLECHA CARDÁN GOMA 209 (INCLUYE BALERO 88508)	219
		GOMA PARA SOPORTE DE FLECHA CARDÁN 411 (USA BALERO 88509)	226
		SOPORTE PARA FLECHA CARDÁN GOMA 226 (INCLUYE BALERO 88509)	411
		GOMA PARA SOPORTE DE FLECHA CARDÁN EN POLIURETANO 9219 (USA BALERO 88508)	9209
		SOPORTE PARA FLECHA CARDÁN EN POLIURETANO GOMA 9209 (INCLUYE BALERO 88508)	9219
		GOMA PARA SOPORTE DE FLECHA CARDÁN EN POLIURETANO 9411 (USA BALERO 88508)	9226

GOMAS Y SOPORTES PARA FLECHA CARDÁN

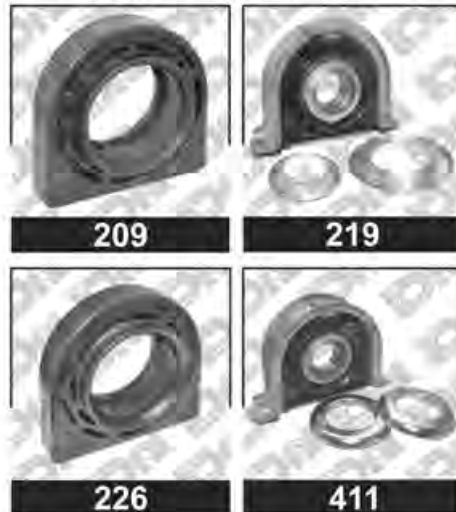

CONTINUACIÓN... D-200

		APLICACIÓN / DESCRIPTION	DAI PARTS #
GOMAS PARA SOPORTES DE FLECHA CARDÁN / SOPORTES COMPLETOS DE FLECHA CARDÁN			
L6 3.7 L6 4.0 V6 3.9 V8 5.2 V8 5.7	75-94	SOPORTE PARA FLECHA CARDÁN EN POLIURETANO GOMA 9226 (INCLUYE BALERO 88509)	9411
		GOMA PARA SOPORTE DE FLECHA CARDÁN DAI-219 (USA BALERO 88508)	DAI-209
		SOPORTE PARA FLECHA CARDÁN GOMA 209 (INCLUYE BALERO 88508)	DAI-219
		GOMA PARA SOPORTE DE FLECHA CARDÁN 411 (USA BALERO 88509)	DAI-226
		SOPORTE PARA FLECHA CARDÁN GOMA 226 (INCLUYE BALERO 88509)	DAI-411
		BALERO PARA SOPORTE DE FLECHA CARDÁN SOPORTES 224, 414, DAI-416 GOMAS 207 Y 230	88107
		BALERO PARA SOPORTE DE FLECHA CARDÁN SOPORTES 219, 9219, DAI-219, DAI-421 GOMAS 209, 9209, DAI-209 Y 225	88508
		BALERO PARA SOPORTE DE FLECHA CARDÁN SOPORTES 411, 9411, DAI-411 GOMAS 226, 9226 Y DAI-226	88509

GOMAS Y SOPORTES PARA FLECHA CARDÁN

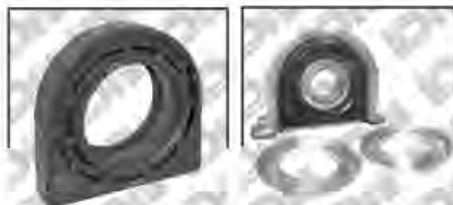
DAI-209
DAI-219

DAI-226
DAI-411

9411
88107



88508
88509
D-250

GOMAS PARA SOPORTES DE FLECHA CARDÁN / SOPORTES COMPLETOS DE FLECHA CARDÁN			
L6 3.7 L6 4.0 V6 3.9 V8 5.2 V8 5.7	75-94	GOMA PARA SOPORTE DE FLECHA CARDÁN DAI-219 (USA BALERO 88508)	209
		SOPORTE PARA FLECHA CARDÁN GOMA 209 (INCLUYE BALERO 88508)	219

GOMAS Y SOPORTES PARA FLECHA CARDÁN

209
219

CONTINUACIÓN... D-250

 		APLICACIÓN / DESCRIPTION	DAI PARTS #
GOMAS PARA SOPORTES DE FLECHA CARDÁN / SOPORTES COMPLETOS DE FLECHA CARDÁN			
L6 3.7 L6 4.0 V6 3.9 V8 5.2 V8 5.7	75-94	GOMA PARA SOPORTE DE FLECHA CARDÁN 411 (USA BALERO 88509)	226
		GOMA PARA SOPORTE DE FLECHA CARDÁN EN POLIURETANO 9219 (USA BALERO 88508)	9209
		SOPORTE PARA FLECHA CARDÁN EN POLIURETANO GOMA 9209 (INCLUYE BALERO 88508)	9219
		GOMA PARA SOPORTE DE FLECHA CARDÁN EN POLIURETANO 9411 (USA BALERO 88508)	9226
		GOMA PARA SOPORTE DE FLECHA CARDÁN DAI-219 (USA BALERO 88508)	DAI-209
		SOPORTE PARA FLECHA CARDÁN GOMA 209 (INCLUYE BALERO 88508)	DAI-219
		GOMA PARA SOPORTE DE FLECHA CARDÁN 411 (USA BALERO 88509)	DAI-226
		BALERO PARA SOPORTE DE FLECHA CARDÁN SOPORTES 224, 414, DAI-416 GOMAS 207 Y 230	88107
		BALERO PARA SOPORTE DE FLECHA CARDÁN SOPORTES 219, 9219, DAI-219, DAI-421 GOMAS 209, 9209, DAI-209 Y 225	88508
		BALERO PARA SOPORTE DE FLECHA CARDÁN SOPORTES 411, 9411, DAI-411 GOMAS 226, 9226 Y DAI-226	88509

GOMAS Y SOPORTES PARA FLECHA CARDÁN



D-300

		APLICACIÓN / DESCRIPTION	DAI PARTS #
GOMAS PARA SOPORTES DE FLECHA CARDÁN / SOPORTES COMPLETOS DE FLECHA CARDÁN			
L6 3.7 L6 4.0 V6 3.9 V8 5.2 V8 5.7	75-94	GOMA PARA SOPORTE DE FLECHA CARDÁN DAI-219 (USA BALERO 88508)	209
		SOPORTE PARA FLECHA CARDÁN GOMA 209 (INCLUYE BALERO 88508)	219
		GOMA PARA SOPORTE DE FLECHA CARDÁN 411 (USA BALERO 88509)	226
		SOPORTE PARA FLECHA CARDÁN GOMA 226 (INCLUYE BALERO 88509)	411
		GOMA PARA SOPORTE DE FLECHA CARDÁN EN POLIURETANO 9219 (USA BALERO 88508)	9209
		SOPORTE PARA FLECHA CARDÁN EN POLIURETANO GOMA 9209 (INCLUYE BALERO 88508)	9219
		GOMA PARA SOPORTE DE FLECHA CARDÁN EN POLIURETANO 9411 (USA BALERO 88508)	9226
		SOPORTE PARA FLECHA CARDÁN EN POLIURETANO GOMA 9226 (BALERO 88509)	9411
		GOMA PARA SOPORTE DE FLECHA CARDÁN DAI-219 (USA BALERO 88508)	DAI-209
		SOPORTE PARA FLECHA CARDÁN GOMA 209 (INCLUYE BALERO 88508)	DAI-219
		GOMA PARA SOPORTE DE FLECHA CARDÁN 411 (USA BALERO 88509)	DAI-226
		SOPORTE PARA FLECHA CARDÁN GOMA 226 (INCLUYE BALERO 88509)	DAI-411
		BALERO PARA SOPORTE DE FLECHA CARDÁN SOPORTES 224, 414, DAI-416 GOMAS 207 Y 230	88107
BALERO PARA SOPORTE DE FLECHA CARDÁN SOPORTES 219, 9219, DAI-219, DAI-421 GOMAS 209, 9209, DAI-209 Y 225	88508		

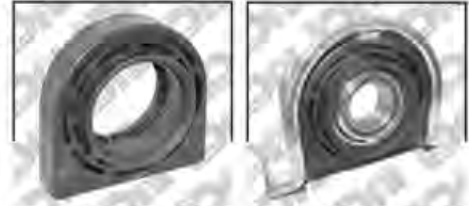
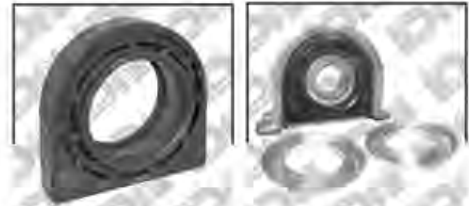
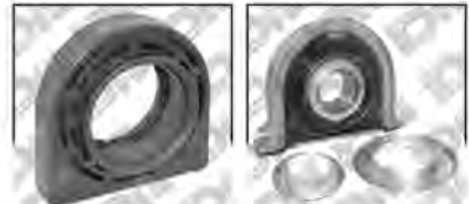
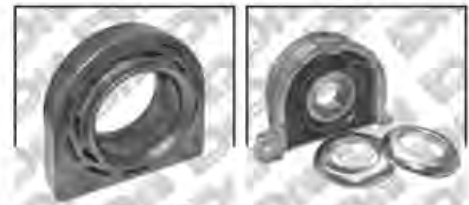
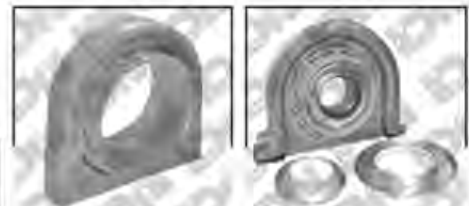
GOMAS Y SOPORTES PARA FLECHA CARDÁN

DAI-209
DAI-219

DAI-226
DAI-411

209
219

226
411

9209
9219

9226
9411
88107
88508

CONTINUACIÓN... D-300

  28		APLICACIÓN / DESCRIPTION	DAI PARTS #
GOMAS PARA SOPORTES DE FLECHA CARDÁN / SOPORTES COMPLETOS DE FLECHA CARDÁN			
L6 3.7 L6 4.0 V6 3.9 V8 5.2 V8 5.7	75-94	BALERO PARA SOPORTE DE FLECHA CARDÁN SOPORTES 411, 9411, DAI-411 GOMAS 226, 9226 Y DAI-226	88509



D-350

GOMAS PARA SOPORTES DE FLECHA CARDÁN / SOPORTES COMPLETOS DE FLECHA CARDÁN			
L6 3.7 L6 4.0 V6 3.9 V8 5.2 V8 5.7	75-94	GOMA PARA SOPORTE DE FLECHA CARDÁN DAI-219 (USA BALERO 88508)	209
		SOPORTE PARA FLECHA CARDÁN GOMA 209 (INCLUYE BALERO 88508)	219
		GOMA PARA SOPORTE DE FLECHA CARDÁN 411 (USA BALERO 88509)	226
		SOPORTE PARA FLECHA CARDÁN GOMA 226 (INCLUYE BALERO 88509)	411
		GOMA PARA SOPORTE DE FLECHA CARDÁN EN POLIURETANO 9219 (USA BALERO 88508)	9209
		SOPORTE PARA FLECHA CARDÁN EN POLIURETANO GOMA 9209 (INCLUYE BALERO 88508)	9219
		GOMA PARA SOPORTE DE FLECHA CARDÁN EN POLIURETANO 9411 (USA BALERO 88508)	9226
		SOPORTE PARA FLECHA CARDÁN EN POLIURETANO GOMA 9226 (BALERO 88509)	9411
		GOMA PARA SOPORTE DE FLECHA CARDÁN DAI-219 (USA BALERO 88508)	DAI-209
		SOPORTE PARA FLECHA CARDÁN GOMA 209 (INCLUYE BALERO 88508)	DAI-219



CONTINUACIÓN... 350

  28		APLICACIÓN / DESCRIPTION	DAI PARTS #
GOMAS PARA SOPORTES DE FLECHA CARDÁN / SOPORTES COMPLETOS DE FLECHA CARDÁN			
L6 3.7 L6 4.0 V6 3.9 V8 5.2 V8 5.7	75-94	GOMA PARA SOPORTE DE FLECHA CARDÁN 411 (USA BALERO 88509)	DAI-226
		SOPORTE PARA FLECHA CARDÁN GOMA 226 (INCLUYE BALERO 88509)	DAI-411
		BALERO PARA SOPORTE DE FLECHA CARDÁN SOPORTES 224, 414, DAI-416 GOMAS 207 Y 230	88107
		BALERO PARA SOPORTE DE FLECHA CARDÁN SOPORTES 219, 9219, DAI-219, DAI-421 GOMAS 209, 9209, DAI-209 Y 225	88508
		BALERO PARA SOPORTE DE FLECHA CARDÁN SOPORTES 411, 9411, DAI-411 GOMAS 226, 9226 Y DAI-226	88509

DAKOTA

GOMAS PARA SOPORTES DE FLECHA CARDÁN / SOPORTES COMPLETOS DE FLECHA CARDÁN		GOMAS Y SOPORTES PARA FLECHA CARDÁN	
V6 3.9 V8 5.2 V8 5.9	87-99 97-99 98-99	GOMA PARA SOPORTE DE FLECHA CARDÁN DAI-219 (USA BALERO 88508)	209
		SOPORTE PARA FLECHA CARDÁN GOMA 209 (INCLUYE BALERO 88508)	219
		GOMA PARA SOPORTE DE FLECHA CARDÁN EN POLIURETANO 9219 (USA BALERO 88508)	9209
		SOPORTE PARA FLECHA CARDÁN EN POLIURETANO GOMA 9209 (INCLUYE BALERO 88508)	9219



CONTINUACIÓN... DAKOTA

 		APLICACIÓN / DESCRIPTION	DAI PARTS #
GOMAS PARA SOPORTES DE FLECHA CARDÁN / SOPORTES COMPLETOS DE FLECHA CARDÁN			
V6 3.9 V8 5.2 V8 5.9	87-99	GOMA PARA SOPORTE DE FLECHA CARDÁN DAI-219 (USA BALERO 88508)	DAI-209
	97-99	SOPORTE PARA FLECHA CARDÁN GOMA 209 (INCLUYE BALERO 88508)	DAI-219
	98-99	BALERO PARA SOPORTE DE FLECHA CARDÁN SOPORTES 219, 9219, DAI-219 Y DAI-421 GOMAS 209, 9209, DAI-209 Y 225	88508



DURANGO

 		APLICACIÓN / DESCRIPTION	DAI PARTS #
GOMAS PARA SOPORTES DE FLECHA CARDÁN / SOPORTES COMPLETOS DE FLECHA CARDÁN			
V6 3.9 V8 5.2 V8 5.9	98-99	GOMA PARA SOPORTE DE FLECHA CARDÁN DAI-219 (USA BALERO 88508)	209
		SOPORTE PARA FLECHA CARDÁN GOMA 209 (INCLUYE BALERO 88508)	219
		GOMA PARA SOPORTE DE FLECHA CARDÁN EN POLIURETANO 9219 (USA BALERO 88508)	9209
		SOPORTE PARA FLECHA CARDÁN EN POLIURETANO GOMA 9209 (INCLUYE BALERO 88508)	9219
		GOMA PARA SOPORTE DE FLECHA CARDÁN DAI-219 (USA BALERO 88508)	DAI-209
		SOPORTE PARA FLECHA CARDÁN GOMA 209 (INCLUYE BALERO 88508)	DAI-219

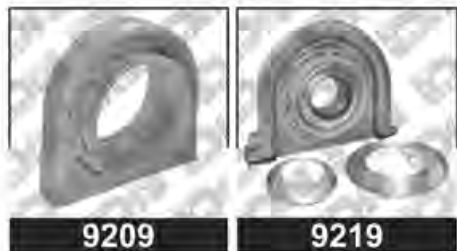

CONTINUACIÓN... DURANGO

		APLICACIÓN / DESCRIPTION	DAI PARTS #
GOMAS PARA SOPORTES DE FLECHA CARDÁN / SOPORTES COMPLETOS DE FLECHA CARDÁN			
V6 3.9 V8 5.2 V8 5.9	98-99	BALERO PARA SOPORTE DE FLECHA CARDÁN SOPORTES 219, 9219, DAI-219 Y DAI-421 GOMAS 209, 9209, DAI-209 Y 225	88508

GOMAS Y SOPORTES PARA FLECHA CARDÁN

88508
RAM 1500
GOMAS PARA SOPORTES DE FLECHA CARDÁN / SOPORTES COMPLETOS DE FLECHA CARDÁN

V6 3.9 V8 5.2 V8 4.7 V8 5.7 V8 5.9	94-01 02-03 94-03	GOMA PARA SOPORTE DE FLECHA CARDÁN 411 (USA BALERO 88509)	226
		SOPORTE PARA FLECHA CARDÁN GOMA 226 (INCLUYE BALERO 88509)	411
		GOMA PARA SOPORTE DE FLECHA CARDÁN EN POLIURETANO 9411 (USA BALERO 88508)	9226
		SOPORTE PARA FLECHA CARDÁN EN POLIURETANO GOMA 9226 (INCLUYE BALERO 88509)	9411
		GOMA PARA SOPORTE DE FLECHA CARDÁN 411 (USA BALERO 88509)	DAI-226
		SOPORTE PARA FLECHA CARDÁN GOMA 226 (INCLUYE BALERO 88509)	DAI-411
		BALERO PARA SOPORTE DE FLECHA CARDÁN SOPORTES 224, 414, DAI-416 GOMAS 207 Y 230	88107
BALERO PARA SOPORTE DE FLECHA CARDÁN SOPORTES 411, 9411, DAI-411 GOMAS 226, 9226 Y DAI-226	88509		

GOMAS Y SOPORTES PARA FLECHA CARDÁN

DAI-226

DAI-411

226



411

9226

9411

88107
88509

RAM 2500

 		APLICACIÓN / DESCRIPTION	DAI PARTS #
GOMAS PARA SOPORTES DE FLECHA CARDÁN / SOPORTES COMPLETOS DE FLECHA CARDÁN			
V6 3.9 V8 5.2 V8 4.7 V8 5.7 V8 5.9	94-01 02-03 94-03	GOMA PARA SOPORTE DE FLECHA CARDÁN 411 (USA BALERO 88509)	226
		SOPORTE PARA FLECHA CARDÁN GOMA 226 (INCLUYE BALERO 88509)	411
		GOMA PARA SOPORTE DE FLECHA CARDÁN EN POLIURETANO 9411 (USA BALERO 88508)	9226
		SOPORTE PARA FLECHA CARDÁN EN POLIURETANO GOMA 9226 (INCLUYE BALERO 88509)	9411
		GOMA PARA SOPORTE DE FLECHA CARDÁN 411 (USA BALERO 88509)	DAI-226
		SOPORTE PARA FLECHA CARDÁN GOMA 226 (INCLUYE BALERO 88509)	DAI-411
		BALERO PARA SOPORTE DE FLECHA CARDÁN SOPORTES 224, 414, DAI-416 GOMAS 207 Y 230	88107
		BALERO PARA SOPORTE DE FLECHA CARDÁN SOPORTES 411, 9411, DAI-411 GOMAS 226, 9226 Y DAI-226	88509

GOMAS Y SOPORTES PARA FLECHA CARDÁN



RAM CHARGER

 		APLICACIÓN / DESCRIPTION	DAI PARTS #
GOMAS PARA SOPORTES DE FLECHA CARDÁN / SOPORTES COMPLETOS DE FLECHA CARDÁN			
V6 3.7 V8 5.2 V8 7.2 V8 5.9	75-94	GOMA PARA SOPORTE DE FLECHA CARDÁN DAI-219 (USA BALERO 88508)	209
		SOPORTE PARA FLECHA CARDÁN GOMA 209 (INCLUYE BALERO 88508)	219

GOMAS Y SOPORTES PARA FLECHA CARDÁN

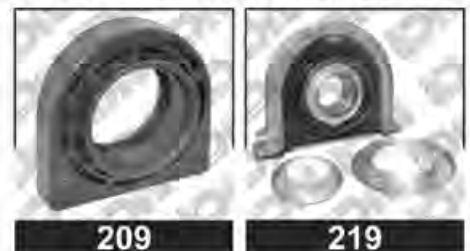

CONTINUACIÓN... RAM CHARGER

		APLICACIÓN / DESCRIPTION	DAI PARTS #
GOMAS PARA SOPORTES DE FLECHA CARDÁN / SOPORTES COMPLETOS DE FLECHA CARDÁN			
V6 3.7 V8 5.2 V8 7.2 V8 5.9	75-94	GOMA PARA SOPORTE DE FLECHA CARDÁN EN POLIURETANO 9219 (USA BALERO 88508)	9209
		SOPORTE PARA FLECHA CARDÁN EN POLIURETANO GOMA 9209 (INCLUYE BALERO 88508)	9219
		GOMA PARA SOPORTE DE FLECHA CARDÁN DAI-219 (USA BALERO 88508)	DAI-209
		SOPORTE PARA FLECHA CARDÁN GOMA 209 (INCLUYE BALERO 88508)	DAI-219
		BALERO PARA SOPORTE DE FLECHA CARDÁN SOPORTES 219, 9219, DAI-219, DAI-421 GOMAS 209, 9209, DAI-209 Y 225	88508



FORD

GOMAS PARA SOPORTE DE FLECHA CARDÁN / SOPORTES COMPLETO DE FECHA CARDÁN

F-100

		APLICACIÓN / DESCRIPTION	DAI PARTS #
---	---	--------------------------	-------------

GOMAS PARA SOPORTES DE FLECHA CARDÁN / SOPORTES COMPLETOS DE FLECHA CARDÁN

L6 3.9 L6 4.9 V6 4.2	65-76 95-96 97-98	GOMA PARA SOPORTE DE FLECHA CARDÁN 224, 414 Y DAI-416 (USA BALERO 88107)	207
		SOPORTE PARA FLECHA CARDÁN GOMAS 207, 230 (INCLUYE BALERO 88107)	224
		GOMA PARA SOPORTE DE FLECHA CARDÁN 224, 414 Y DAI-416 (USA BALERO 88107)	230
		SOPORTE PARA FLECHA CARDÁN GOMAS 207, 230 (INCLUYE BALERO 88107)	414
		SOPORTE PARA FLECHA CARDÁN GOMAS 207, 230 (CON BALERO 88107)	DAI-416
		BALERO PARA SOPORTE DE FLECHA CARDÁN SOPORTES 224, 414, DAI-416 GOMAS 207 Y 230	88107

V8 4.6 V8 5.0 V8 5.4 V8 5.8 V8 6.9 V8 7.3 V8 7.5	97-98 69-99 69-03 69-99 83-87 88-98 88-98	GOMA PARA SOPORTE DE FLECHA CARDÁN 224, 414 Y DAI-416 (USA BALERO 88107)	207
		SOPORTE PARA FLECHA CARDÁN GOMAS 207, 230 (INCLUYE BALERO 88107)	224
		GOMA PARA SOPORTE DE FLECHA CARDÁN 411 (USA BALERO 88509)	226
		GOMA PARA SOPORTE DE FLECHA CARDÁN 224, 414 Y DAI-416 (USA BALERO 88107)	230
		SOPORTE PARA FLECHA CARDÁN GOMA 226 (INCLUYE BALERO 88509)	411
		SOPORTE PARA FLECHA CARDÁN GOMAS 207, 230 (INCLUYE BALERO 88107)	414
		GOMA PARA SOPORTE DE FLECHA CARDÁN EN POLIURETANO 9411 (USA BALERO 88508)	9226

GOMAS Y SOPORTES PARA FLECHA CARDÁN

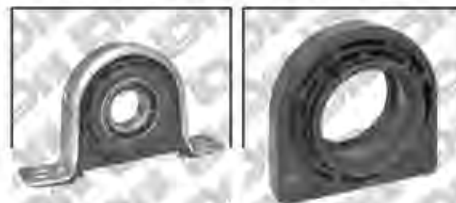

DAI-416

207



224

226

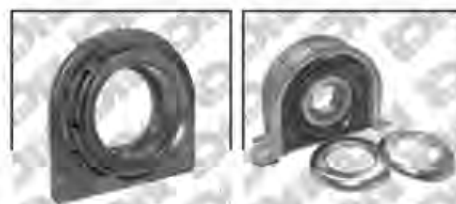

230

411

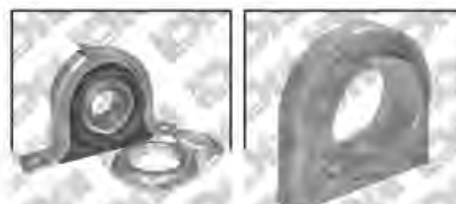

414

9226



88107



CONTINUACIÓN... F-100

 28		APLICACIÓN / DESCRIPTION	DAI PARTS #
GOMAS PARA SOPORTES DE FLECHA CARDÁN / SOPORTES COMPLETOS DE FLECHA CARDÁN			
V8 4.6 V8 5.0 V8 5.4 V8 5.8 V8 6.9 V8 7.3 V8 7.5	97-98 69-99 69-03 69-99 83-87 88-98 88-98	SOPORTE PARA FLECHA CARDÁN EN POLIURETANO GOMA 9226 (INCLUYE BALERO 88509)	9411
		GOMA PARA SOPORTE DE FLECHA CARDÁN 411 (USA BALERO 88509)	DAI-226
		SOPORTE PARA FLECHA CARDÁN GOMA 226 (INCLUYE BALERO 88509)	DAI-411
		SOPORTE PARA FLECHA CARDÁN GOMAS 207, 230 (CON BALERO 88107)	DAI-416
		BALERO PARA SOPORTE DE FLECHA CARDÁN SOPORTES 224, 414, DAI-416 GOMAS 207 Y 230	88107
		BALERO PARA SOPORTE DE FLECHA CARDÁN SOPORTES 411, 9411, DAI-411 GOMAS 226, 9226 Y DAI-226	88509
		V8 6.8	99-03
SOPORTE PARA FLECHA CARDÁN GOMA 226 (USA BALERO 88509)	411		
GOMA PARA SOPORTE DE FLECHA CARDÁN EN POLIURETANO 9411 (USA BALERO 88508)	9226		
SOPORTE PARA FLECHA CARDÁN EN POLIURETANO GOMA 9226 (INCLUYE BALERO 88509)	9411		
GOMA PARA SOPORTE DE FLECHA CARDÁN 411 (USA BALERO 88509)	DAI-226		
SOPORTE PARA FLECHA CARDÁN GOMA 226 (INCLUYE BALERO 88509)	DAI-411		
BALERO PARA SOPORTE DE FLECHA CARDÁN SOPORTES 224, 414, DAI-416 GOMAS 207 Y 230	88107		
BALERO PARA SOPORTE DE FLECHA CARDÁN SOPORTES 411, 9411, DAI-411 GOMAS 226, 9226 Y DAI-226	88509		
V8 5.9	68-76	GOMA PARA SOPORTE DE FLECHA CARDÁN 224, 414 Y DAI-416 (USA BALERO 88107)	207

GOMAS Y SOPORTES PARA FLECHA CARDÁN

DAI-226

DAI-411

DAI-416

207

226

411

9226

9411

88107

88509

CONTINUACIÓN... F-100

		APLICACIÓN / DESCRIPTION	DAI PARTS #
GOMAS PARA SOPORTES DE FLECHA CARDÁN / SOPORTES COMPLETOS DE FLECHA CARDÁN			
V8 5.9	68-76	SOPORTE PARA FLECHA CARDÁN GOMAS 207, 230 (INCLUYE BALERO 88107)	224
		GOMA PARA SOPORTE DE FLECHA CARDÁN 224, 414 Y DAI-416 (USA BALERO 88107)	230
		SOPORTE PARA FLECHA CARDÁN GOMAS 207, 230 (INCLUYE BALERO 88107)	414
		SOPORTE PARA FLECHA CARDÁN GOMAS 207, 230 (CON BALERO 88107)	DAI-416
		BALERO PARA SOPORTE DE FLECHA CARDÁN SOPORTES 224, 414, DAI-416 GOMAS 207 Y 230	88107

GOMAS Y SOPORTES PARA FLECHA/CARDÁN

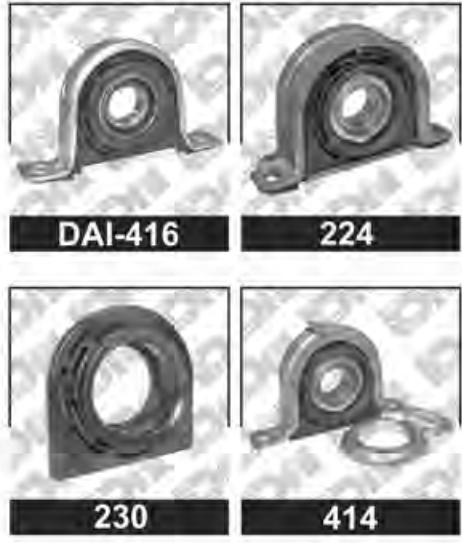

F-150

GOMAS PARA SOPORTES DE FLECHA CARDÁN / SOPORTES COMPLETOS DE FLECHA CARDÁN			
L6 3.9	77-87	GOMA PARA SOPORTE DE FLECHA CARDÁN 224, 414 Y DAI-416 (USA BALERO 88107)	207
L6 4.9	95-96	SOPORTE PARA FLECHA CARDÁN GOMAS 207, 230 (INCLUYE BALERO 88107)	224
V6 4.2	97-98	GOMA PARA SOPORTE DE FLECHA CARDÁN 224, 414 Y DAI-416 (USA BALERO 88107)	230
V8 5.9	68-76	SOPORTE PARA FLECHA CARDÁN GOMAS 207, 230 (INCLUYE BALERO 88107)	414
V8 7.3	88-98		

GOMAS Y SOPORTES PARA FLECHA/CARDÁN

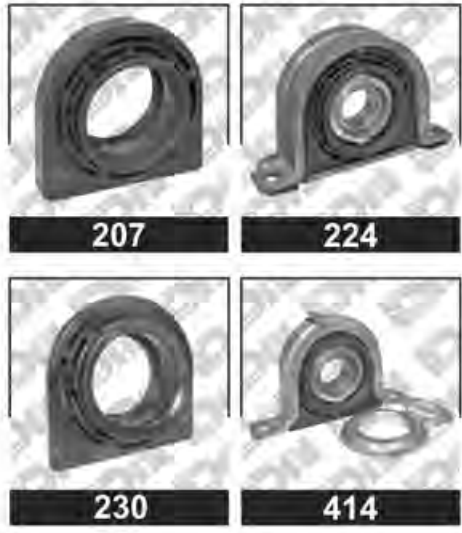

CONTINUACIÓN... F-150

 		APLICACIÓN / DESCRIPTION	DAI PARTS #
GOMAS PARA SOPORTES DE FLECHA CARDÁN / SOPORTES COMPLETOS DE FLECHA CARDÁN			
L6 3.9	77-87	SOPORTE PARA FLECHA CARDÁN	DAI-416
L6 4.9	95-96	GOMAS 207, 230 (CON BALERO 88107)	
V6 4.2	97-98	BALERO PARA SOPORTE DE FLECHA CARDÁN	88107
V8 5.9	68-76	SOPORTES 224, 414, DAI-416	
V8 7.3	88-98	GOMAS 207 Y 230	

V8 4.6	97-98	GOMA PARA SOPORTE DE FLECHA CARDÁN 224, 414 Y DAI-416 (USA BALERO 88107)	207
		SOPORTE PARA FLECHA CARDÁN GOMAS 207, 230 (INCLUYE BALERO 88107)	224
		GOMA PARA SOPORTE DE FLECHA CARDÁN 224, 414 Y DAI-416 (USA BALERO 88107)	230
		SOPORTE PARA FLECHA CARDÁN GOMAS 207 Y 230 (INCLUYE BALERO 88107)	414
		SOPORTE PARA FLECHA CARDÁN GOMAS 207 Y 230 (CON BALERO 88107)	DAI-416
		BALERO PARA SOPORTE DE FLECHA CARDÁN SOPORTES 224, 414 Y DAI-416 GOMAS 207 Y 230	88107
	97-03	GOMA PARA SOPORTE DE FLECHA CARDÁN 411 (USA BALERO 88509)	226
		SOPORTE PARA FLECHA CARDÁN GOMA 226 (USA BALERO 88509)	411
		GOMA PARA SOPORTE DE FLECHA CARDÁN EN POLIURETANO 9411 (USA BALERO 88508)	9226
		SOPORTE PARA FLECHA CARDÁN EN POLIURETANO GOMA 9226 (INCLUYE BALERO 88509)	9411
		GOMA PARA SOPORTE DE FLECHA CARDÁN 411 (USA BALERO 88509)	DAI-226
		SOPORTE PARA FLECHA CARDÁN GOMA 226 (INCLUYE BALERO 88509)	DAI-411

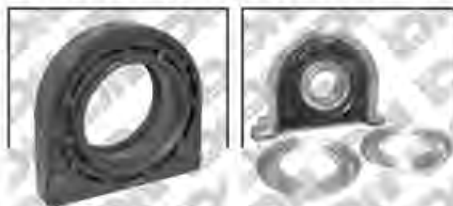
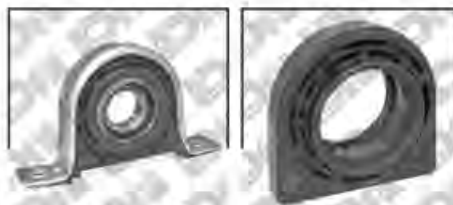
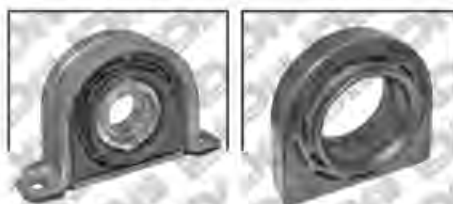
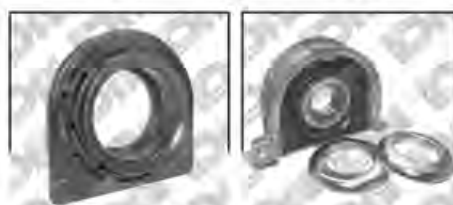
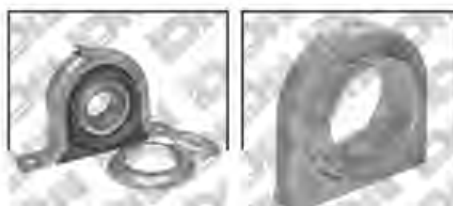
GOMAS Y SOPORTES PARA FLECHA CARDÁN

DAI-226
DAI-411

DAI-416
207

224
226

230
411

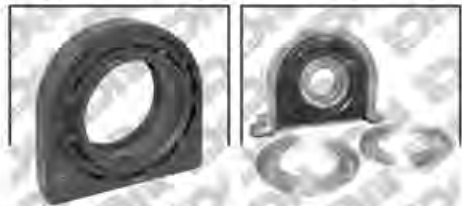
414
9226

9411
88107



CONTINUACIÓN... F-150

		APLICACIÓN / DESCRIPTION	DAI PARTS #
GOMAS PARA SOPORTES DE FLECHA CARDÁN / SOPORTES COMPLETOS DE FLECHA CARDÁN			
V8 4.6	97-03	BALERO PARA SOPORTE DE FLECHA CARDÁN SOPORTES 411, 9411, DAI-411 GOMAS 226, 9226 Y DAI-226	88509
V8 5.0 V8 5.8 V8 6.9 V8 7.5	69-99 69-99 83-87 83-87	GOMA PARA SOPORTE DE FLECHA CARDÁN 224, 414 Y DAI-416 (USA BALERO 88107)	207
		SOPORTE PARA FLECHA CARDÁN GOMAS 207, 230 (INCLUYE BALERO 88107)	224
		GOMA PARA SOPORTE DE FLECHA CARDÁN 411 (USA BALERO 88509)	226
		GOMA PARA SOPORTE DE FLECHA CARDÁN 224, 414 Y DAI-416 (USA BALERO 88107)	230
		SOPORTE PARA FLECHA CARDÁN GOMA 226 (USA BALERO 88509)	411
		SOPORTE PARA FLECHA CARDÁN GOMAS 207, 230 (INCLUYE BALERO 88107)	414
		GOMA PARA SOPORTE DE FLECHA CARDÁN EN POLIURETANO 9411 (USA BALERO 88508)	9226
		SOPORTE PARA FLECHA CARDÁN EN POLIURETANO GOMA 9226 (INCLUYE BALERO 88509)	9411
		GOMA PARA SOPORTE DE FLECHA CARDÁN 411 (USA BALERO 88509)	DAI-226
		SOPORTE PARA FLECHA CARDÁN GOMA 226 (INCLUYE BALERO 88509)	DAI-411
		SOPORTE PARA FLECHA CARDÁN GOMAS 207, 230 (CON BALERO 88107)	DAI-416
		BALERO PARA SOPORTE DE FLECHA CARDÁN SOPORTES 224, 414, DAI-416 GOMAS 207 Y 230	88107
		BALERO PARA SOPORTE DE FLECHA CARDÁN SOPORTES 411, 9411, DAI-411 GOMAS 226, 9226 Y DAI-226	88509

GOMAS Y SOPORTES PARA FLECHA CARDÁN

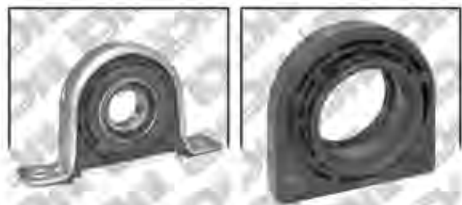

DAI-226 DAI-411



DAI-416 207

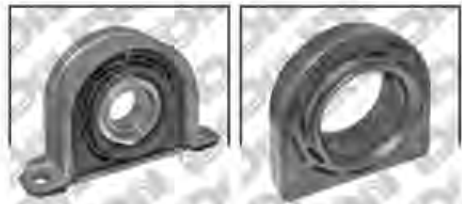

224 226

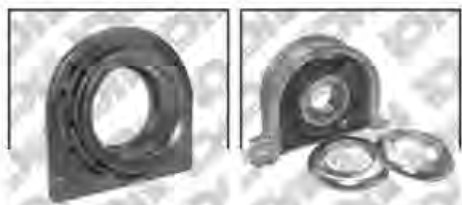

230 411

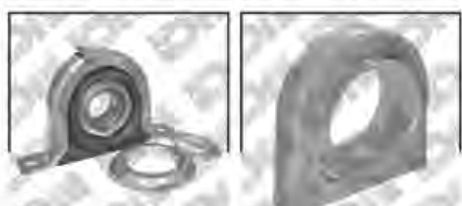

414 9226



9411 88107 88509



CONTINUACIÓN... F-150

  28		APLICACIÓN / DESCRIPTION	DAI PARTS #
GOMAS PARA SOPORTES DE FLECHA CARDÁN / SOPORTES COMPLETOS DE FLECHA CARDÁN			
V8 5.4	69-99	GOMA PARA SOPORTE DE FLECHA CARDÁN 224, 414 Y DAI-416 (USA BALERO 88107)	207
		SOPORTE PARA FLECHA CARDÁN GOMAS 207, 230 (INCLUYE BALERO 88107)	224
		GOMA PARA SOPORTE DE FLECHA CARDÁN 224, 414 Y DAI-416 (USA BALERO 88107)	230
		SOPORTE PARA FLECHA CARDÁN GOMAS 207, 230 (INCLUYE BALERO 88107)	414
		SOPORTE PARA FLECHA CARDÁN GOMAS 207, 230 (CON BALERO 88107)	DAI-416
		BALERO PARA SOPORTE DE FLECHA CARDÁN SOPORTES 224, 414, DAI-416 GOMAS 207 Y 230	88107
	69-03	GOMA PARA SOPORTE DE FLECHA CARDÁN 411 (USA BALERO 88509)	226
		SOPORTE PARA FLECHA CARDÁN GOMA 226 (USA BALERO 88509)	411
		GOMA PARA SOPORTE DE FLECHA CARDÁN EN POLIURETANO 9411 (USA BALERO 88508)	9226
		SOPORTE PARA FLECHA CARDÁN EN POLIURETANO GOMA 9226 (INCLUYE BALERO 88509)	9411
		GOMA PARA SOPORTE DE FLECHA CARDÁN 411 (USA BALERO 88509)	DAI-226
		SOPORTE PARA FLECHA CARDÁN GOMA 226 (INCLUYE BALERO 88509)	DAI-411
69-06	BALERO PARA SOPORTE DE FLECHA CARDÁN SOPORTES 411, 9411, DAI-411 GOMAS 226, 9226 Y DAI-226	88509	

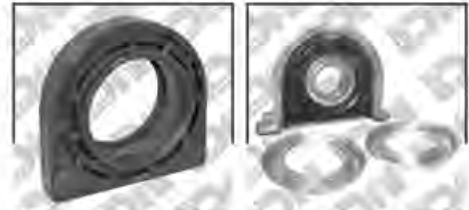
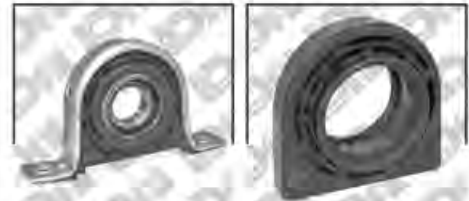
GOMAS Y SOPORTES PARA FLECHA CARDÁN

DAI-226
DAI-411

DAI-416
207



224
226

230
411

414
9226

9411
88107
88509

CONTINUACIÓN... F-150

  28		APLICACIÓN / DESCRIPTION	DAI PARTS #
GOMAS PARA SOPORTES DE FLECHA CARDÁN / SOPORTES COMPLETOS DE FLECHA CARDÁN			
V8 6.8 V8 7.3	99-03 88-98	GOMA PARA SOPORTE DE FLECHA CARDÁN 411 (USA BALERO 88509)	226
		SOPORTE PARA FLECHA CARDÁN GOMA 226 (USA BALERO 88509)	411
		GOMA PARA SOPORTE DE FLECHA CARDÁN EN POLIURETANO 9411 (USA BALERO 88508)	9226
		SOPORTE PARA FLECHA CARDÁN EN POLIURETANO GOMA 9226 (INCLUYE BALERO 88509)	9411
		GOMA PARA SOPORTE DE FLECHA CARDÁN 411 (USA BALERO 88509)	DAI-226
		SOPORTE PARA FLECHA CARDÁN GOMA 226 (INCLUYE BALERO 88509)	DAI-411
		BALERO PARA SOPORTE DE FLECHA CARDÁN SOPORTE 224, 414, DAI-416 GOMAS 207 Y 230	88107
V8 6.8	99-03	BALERO PARA SOPORTE DE FLECHA CARDÁN SOPORTES 411, 9411, DAI-411 GOMAS 226, 9226 Y DAI-226	88509

GOMAS Y SOPORTES PARA FLECHA CARDÁN



F-350

 		APLICACIÓN / DESCRIPTION	DAI PARTS #
GOMAS PARA SOPORTES DE FLECHA CARDÁN / SOPORTES COMPLETOS DE FLECHA CARDÁN			
L6 4.9 V6 4.2 V8 4.6	95-96 97-98	GOMA PARA SOPORTE DE FLECHA CARDÁN 224, 414 Y DAI-416 (USA BALERO 88107)	207
V8 5.8 V8 5.9	83-97 68-76	SOPORTE PARA FLECHA CARDÁN GOMAS 207, 230 (INCLUYE BALERO 88107)	224

GOMAS Y SOPORTES PARA FLECHA CARDÁN



CONTINUACIÓN... F-350

  28		APLICACIÓN / DESCRIPTION	DAI PARTS #
GOMAS PARA SOPORTES DE FLECHA CARDÁN / SOPORTES COMPLETOS DE FLECHA CARDÁN			
L6 4.9 V6 4.2 V8 4.6 V8 5.8 V8 5.9	95-96 97-98 83-97 68-76	GOMA PARA SOPORTE DE FLECHA CARDÁN 224, 414 Y DAI-416 (USA BALERO 88107)	230
		SOPORTE PARA FLECHA CARDÁN GOMAS 207, 230 (INCLUYE BALERO 88107)	414
		SOPORTE PARA FLECHA CARDÁN GOMAS 207, 230 (CON BALERO 88107)	DAI-416
		BALERO PARA SOPORTE DE FLECHA CARDÁN SOPORTES 224, 414, DAI-416 GOMAS 207 Y 230	88107
V8 4.6 V8 6.8	97-03 99-03	GOMA PARA SOPORTE DE FLECHA CARDÁN 411 (USA BALERO 88509)	226
		SOPORTE PARA FLECHA CARDÁN GOMA 226 (USA BALERO 88509)	411
		GOMA PARA SOPORTE DE FLECHA CARDÁN EN POLIURETANO 9411 (USA BALERO 88508)	9226
		SOPORTE PARA FLECHA CARDÁN EN POLIURETANO GOMA 9226 (INCLUYE BALERO 88509)	9411
		GOMA PARA SOPORTE DE FLECHA CARDÁN 411 (USA BALERO 88509)	DAI-226
		SOPORTE PARA FLECHA CARDÁN GOMA 226 (INCLUYE BALERO 88509)	DAI-411
		BALERO PARA SOPORTE DE FLECHA CARDÁN SOPORTE 411, 9411 Y DAI-411 GOMAS 226, 9226 Y DAI-226	88509
V8 5.4	69-99	GOMA PARA SOPORTE DE FLECHA CARDÁN 224, 414 Y DAI-416 (USA BALERO 88107)	207
		SOPORTE PARA FLECHA CARDÁN GOMAS 207 Y 230 (INCLUYE BALERO 88107)	224

GOMAS Y SOPORTES PARA FLECHA CARDÁN

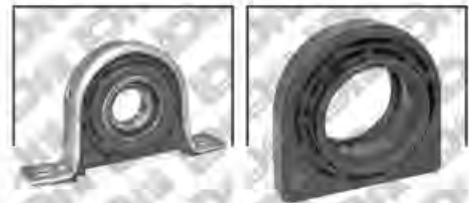
DAI-226
DAI-411

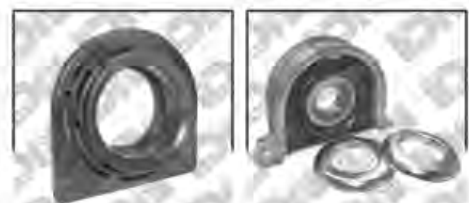
DAI-416
207

224
226

230
411

414
9226

9411
88107
88509

CONTINUACIÓN... F-350

 		APLICACIÓN / DESCRIPTION	DAI PARTS #
GOMAS PARA SOPORTES DE FLECHA CARDÁN / SOPORTES COMPLETOS DE FLECHA CARDÁN			
V8 5.4	69-99	GOMA PARA SOPORTE DE FLECHA CARDÁN 224, 414 Y DAI-416 (USA BALERO 88107)	230
		SOPORTE PARA FLECHA CARDÁN GOMAS 207 Y 230 (INCLUYE BALERO 88107)	414
		SOPORTE PARA FLECHA CARDÁN GOMAS 207 Y 230 (CON BALERO 88107)	DAI-416
		BALERO PARA SOPORTE DE FLECHA CARDÁN SOPORTE 224, 414 Y DAI-416 GOMAS 207 Y 230	88107
	69-03	GOMA PARA SOPORTE DE FLECHA CARDÁN 411 (USA BALERO 88509)	226
		SOPORTE PARA FLECHA CARDÁN GOMA 226 (USA BALERO 88509)	411
		GOMA PARA SOPORTE DE FLECHA CARDÁN EN POLIURETANO 9411 (USA BALERO 88508)	9226
		SOPORTE PARA FLECHA CARDÁN EN POLIURETANO GOMA 9226 (INCLUYE BALERO 88509)	9411
		GOMA PARA SOPORTE DE FLECHA CARDÁN 411 (USA BALERO 88509)	DAI-226
		SOPORTE PARA FLECHA CARDÁN GOMA 226 (INCLUYE BALERO 88509)	DAI-411
BALERO PARA SOPORTE DE FLECHA CARDÁN SOPORTE 411, 9411 Y DAI-411 GOMAS 226, 9226 Y DAI-226	88509		
V8 5.0	69-99	GOMA PARA SOPORTE DE FLECHA CARDÁN 224, 414 Y DAI-416 (USA BALERO 88107)	207
V8 6.9	83-87	SOPORTE PARA FLECHA CARDÁN GOMAS 207 Y 230 (INCLUYE BALERO 88107)	224
V8 7.5	83-87	GOMA PARA SOPORTE DE FLECHA CARDÁN 411 (USA BALERO 88509)	226

GOMAS Y SOPORTES PARA FLECHA CARDÁN



CONTINUACIÓN... F-350

  28		APLICACIÓN / DESCRIPTION	DAI PARTS #
GOMAS PARA SOPORTES DE FLECHA CARDÁN / SOPORTES COMPLETOS DE FLECHA CARDÁN			
V8 5.0 V8 6.9 V8 7.5	69-99	GOMA PARA SOPORTE DE FLECHA CARDÁN 224, 414 Y DAI-416 (USA BALERO 88107)	230
		SOPORTE PARA FLECHA CARDÁN GOMA 226 (USA BALERO 88509)	411
		SOPORTE PARA FLECHA CARDÁN GOMAS 207 Y 230 (INCLUYE BALERO 88107)	414
		GOMA PARA SOPORTE DE FLECHA CARDÁN EN POLIURETANO 9411 (USA BALERO 88508)	9226
	83-87	SOPORTE PARA FLECHA CARDÁN EN POLIURETANO GOMA 9226 (INCLUYE BALERO 88509)	9411
		GOMA PARA SOPORTE DE FLECHA CARDÁN 411 (USA BALERO 88509)	DAI-226
	83-87	SOPORTE PARA FLECHA CARDÁN GOMA 226 (INCLUYE BALERO 88509)	DAI-411
		SOPORTE PARA FLECHA CARDÁN GOMAS 207 Y 230 (CON BALERO 88107)	DAI-416
		BALERO PARA SOPORTE DE FLECHA CARDÁN SOPORTES 224, 414, DAI-416 GOMAS 207 Y 230	88107
		BALERO PARA SOPORTE DE FLECHA CARDÁN SOPORTES 411, 9411 Y DAI-411 GOMAS 226, 9226 Y DAI-226	88509
V8 6.8	99-03	BALERO PARA SOPORTE DE FLECHA CARDÁN SOPORTES 411, 9411 Y DAI-411 GOMAS 226, 9226 Y DAI-226	88509
V8 7.3	83-97	GOMA PARA SOPORTE DE FLECHA CARDÁN 224, 414 Y DAI-416 (USA BALERO 88107)	207
		SOPORTE PARA FLECHA CARDÁN GOMAS 207 Y 230 (INCLUYE BALERO 88107)	224

GOMAS Y SOPORTES PARA FLECHA CARDÁN

DAI-226

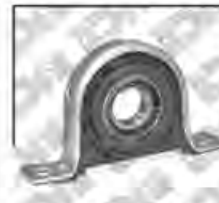
DAI-411

DAI-416

207

224

230

411



414

9226

9411

88107
88509

CONTINUACIÓN... F-350

	 28	APLICACIÓN / DESCRIPTION	DAI PARTS #
GOMAS PARA SOPORTES DE FLECHA CARDÁN / SOPORTES COMPLETOS DE FLECHA CARDÁN			
V8 5.0 V8 5.4 V8 5.9 V8 6.9 V8 7.5 V8 7.3	83-97	GOMA PARA SOPORTE DE FLECHA CARDÁN 224, 414 Y DAI-416 (USA BALERO 88107)	230
		SOPORTE PARA FLECHA CARDÁN GOMAS 207 Y 230 (INCLUYE BALERO 88107)	414
		SOPORTE PARA FLECHA CARDÁN GOMAS 207 Y 230 (CON BALERO 88107)	DAI-416
	88-03	GOMA PARA SOPORTE DE FLECHA CARDÁN 411 (USA BALERO 88509)	226
		SOPORTE PARA FLECHA CARDÁN GOMA 226 (USA BALERO 88509)	411
		GOMA PARA SOPORTE DE FLECHA CARDÁN EN POLIURETANO 9411 (USA BALERO 88508)	9226
		SOPORTE PARA FLECHA CARDÁN EN POLIURETANO GOMA 9226 (INCLUYE BALERO 88509)	9411
		GOMA PARA SOPORTE DE FLECHA CARDÁN 411 (USA BALERO 88509)	DAI-226
		SOPORTE PARA FLECHA CARDÁN GOMA 226 (INCLUYE BALERO 88509)	DAI-411
		BALERO PARA SOPORTE DE FLECHA CARDÁN SOPORTES 224, 414 Y DAI-416 GOMAS 207 Y 230	88107
	BALERO PARA SOPORTE DE FLECHA CARDÁN SOPORTES 411, 9411 Y DAI-411 GOMAS 226, 9226 Y DAI-226	88509	

GOMAS Y SOPORTES PARA FLECHA CARDÁN



DAI-226

DAI-411

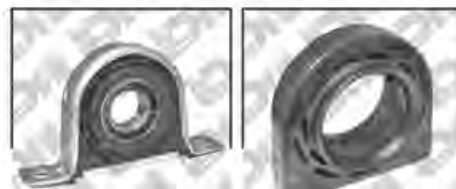

DAI-416

226

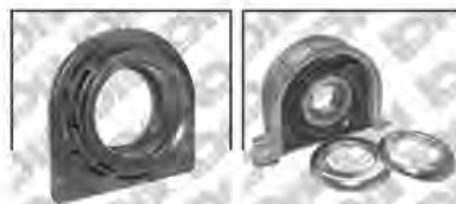

230

411

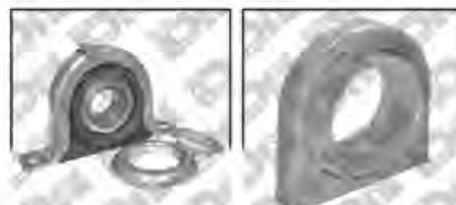

414

9226



9411

88107

88509



RANGER

28		APLICACIÓN / DESCRIPTION	DAI PARTS #
GOMAS PARA SOPORTES DE FLECHA CARDÁN / SOPORTES COMPLETOS DE FLECHA CARDÁN			
V6 2.9 V6 3.0 V6 4.0	86-92	GOMA PARA SOPORTE DE FLECHA CARDÁN 224, 414 Y DAI-416 (USA BALERO 88107)	207
		SOPORTE PARA FLECHA CARDÁN GOMAS 207 Y 230 (INCLUYE BALERO 88107)	224
		GOMA PARA SOPORTE DE FLECHA CARDÁN 224, 414 Y DAI-416 (USA BALERO 88107)	230
		SOPORTE PARA FLECHA CARDÁN GOMAS 207 Y 230 (INCLUYE BALERO 88107)	414
		SOPORTE PARA FLECHA CARDÁN GOMAS 207 Y 230 (CON BALERO 88107)	DAI-416
		BALERO PARA SOPORTE DE FLECHA CARDÁN SOPORTES 224, 414 Y DAI-416 GOMAS 207 Y 230	88107

GOMAS Y SOPORTES PARA FLECHA CARDÁN

LEXUS
GOMAS PARA SOPORTE DE FLECHA CARDÁN / SOPORTES COMPLETO DE FECHA CARDÁN
ES-350

28		APLICACIÓN / DESCRIPTION	DAI PARTS #
GOMAS PARA SOPORTES DE FLECHA CARDÁN / SOPORTES COMPLETOS DE FLECHA CARDÁN			
L6 4.9 V6 4.2 V6 4.6	95-96 97-98	GOMA PARA SOPORTE DE FLECHA CARDÁN DAI-219 (USA BALERO 88508)	209
V8 5.9 V8 7.3	97-98 68-76	SOPORTE PARA FLECHA CARDÁN GOMA 209 (INCLUYE BALERO 88508)	219

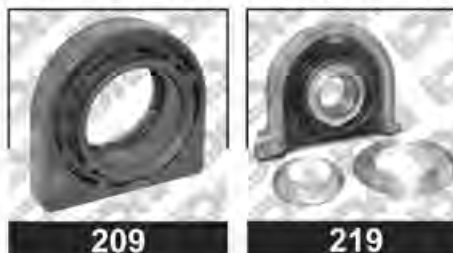
GOMAS Y SOPORTES PARA FLECHA CARDÁN

CONTINUACIÓN... ES-350

		APLICACIÓN / DESCRIPTION	DAI PARTS #
---	---	---------------------------------	--------------------

GOMAS PARA SOPORTES DE FLECHA CARDÁN / SOPORTES COMPLETOS DE FLECHA CARDÁN

L6 4.9 V6 4.2 V6 4.6 V8 5.9 V8 7.3	95-96 97-98 97-98 68-76	GOMA PARA SOPORTE DE FLECHA CARDÁN EN POLIURETANO 9219 (INCLUYE BALERO 88508)	9209
		SOPORTE PARA FLECHA CARDÁN EN POLIURETANO GOMA 9209 (INCLUYE BALERO 88508)	9219
		GOMA PARA SOPORTE DE FLECHA CARDÁN DAI-219 (USA BALERO 88508)	DAI-209
		SOPORTE PARA FLECHA CARDÁN GOMA 209 (INCLUYE BALERO 88508)	DAI-219
		BALERO PARA SOPORTE DE FLECHA CARDÁN SOPORTES 219, 9219, DAI-219 Y DAI-421 GOMAS 209, 9209, DAI-209 Y 225	88508

V8 4.6 V8 6.8 V8 7.3	97-03 69-03 88-03	GOMA PARA SOPORTE DE FLECHA CARDÁN 411 (USA BALERO 88509)	226
		SOPORTE PARA FLECHA CARDÁN GOMA 226 (USA BALERO 88509)	411
		GOMA PARA SOPORTE DE FLECHA CARDÁN EN POLIURETANO 9411 (USA BALERO 88508)	9226
		SOPORTE PARA FLECHA CARDÁN EN POLIURETANO GOMA 9226 (INCLUYE BALERO 88509)	9411
		GOMA PARA SOPORTE DE FLECHA CARDÁN 411 (USA BALERO 88509)	DAI-226
		SOPORTE PARA FLECHA CARDÁN GOMA 226 (INCLUYE BALERO 88509)	DAI-411
		BALERO PARA SOPORTE DE FLECHA CARDÁN SOPORTES 224, 414 Y DAI-416 GOMAS 207 Y 230	88107
BALERO PARA SOPORTE DE FLECHA CARDÁN SOPORTES 411, 9411 Y DAI-411 GOMAS 226, 9226 Y DAI-226	88509		

GOMAS Y SOPORTES PARA FLECHA CARDÁN

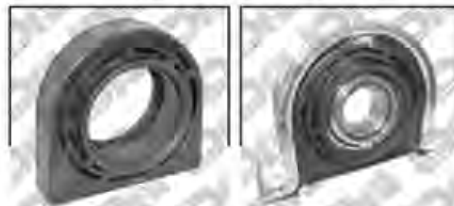

DAI-209

DAI-219

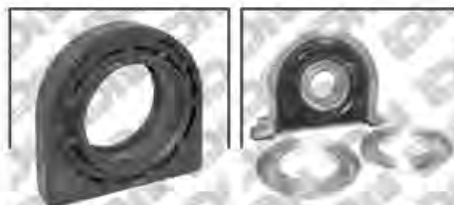

DAI-226

DAI-411

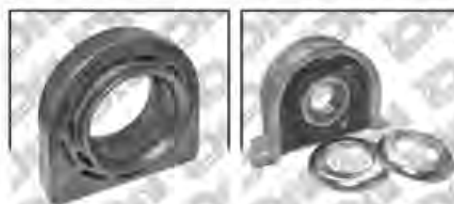

226

411

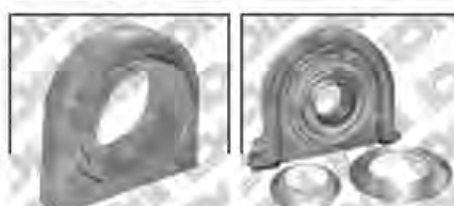

9209

9219



9226

9411



88107

88508

88509

CONTINUACIÓN... ES-350

		APLICACIÓN / DESCRIPTION	DAI PARTS #
GOMAS PARA SOPORTES DE FLECHA CARDÁN / SOPORTES COMPLETOS DE FLECHA CARDÁN			
V8 5.0 V8 7.3	69-99	GOMA PARA SOPORTE DE FLECHA CARDÁN DAI-219 (USA BALERO 88508)	209
		SOPORTE PARA FLECHA CARDÁN GOMA 209 (USA BALERO 88508)	219
		SOPORTE PARA FLECHA CARDÁN GOMA 226 (USA BALERO 88509)	411
		GOMA PARA SOPORTE DE FLECHA CARDÁN EN POLIURETANO 9219 (USA BALERO 88508)	9209
		SOPORTE PARA FLECHA CARDÁN EN POLIURETANO GOMA 9209 (INCLUYE BALERO 88508)	9219
		SOPORTE PARA FLECHA CARDÁN EN POLIURETANO GOMA 9226 (INCLUYE BALERO 88509)	9411
		GOMA PARA SOPORTE DE FLECHA CARDÁN DAI-219 (USA BALERO 88508)	DAI-209
		SOPORTE PARA FLECHA CARDÁN GOMA 209 (INCLUYE BALERO 88508)	DAI-219
		SOPORTE PARA FLECHA CARDÁN GOMA 226 (INCLUYE BALERO 88509)	DAI-411
		BALERO PARA SOPORTE DE FLECHA CARDÁN SOPORTES 224, 414 Y DAI-416 GOMAS 207 Y 230	88107
BALERO PARA SOPORTE DE FLECHA CARDÁN SOPORTES 219, 9219, DAI-219 Y DAI-421 GOMAS 209, 9209, DAI-209 Y 225	88508		
BALERO PARA SOPORTE DE FLECHA CARDÁN SOPORTES 411, 9411 Y DAI-411 GOMAS 226, 9226 Y DAI-226	88509		

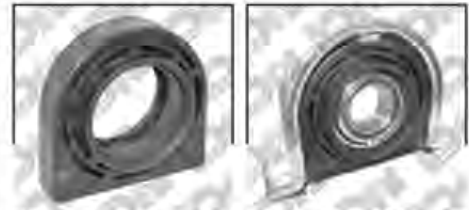
GOMAS Y SOPORTES PARA FLECHA CARDÁN

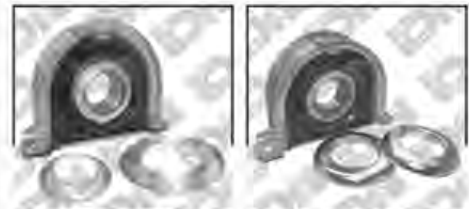
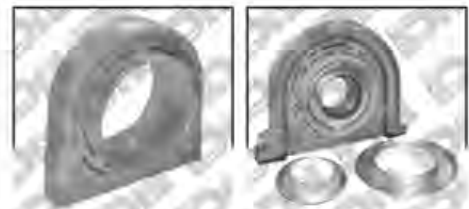
DAI-209
DAI-219

DAI-411
209

219
411

9209
9219

9411
88107
88508
88509

CONTINUACIÓN... ES-350

		APLICACIÓN / DESCRIPTION	DAI PARTS #
GOMAS PARA SOPORTES DE FLECHA CARDÁN / SOPORTES COMPLETOS DE FLECHA CARDÁN			
V8 5.0	84-99	GOMA PARA SOPORTE DE FLECHA CARDÁN 411 (USA BALERO 88509)	226
		GOMA PARA SOPORTE DE FLECHA CARDÁN EN POLIURETANO 9411 (USA BALERO 88508)	9226
		GOMA PARA SOPORTE DE FLECHA CARDÁN 411 (USA BALERO 88509)	DAI-226

V8 5.4 V8 5.8	69-99	GOMA PARA SOPORTE DE FLECHA CARDÁN DAI-219 (USA BALERO 88508)	209	
		SOPORTE PARA FLECHA CARDÁN GOMA 209 (USA BALERO 88508)	219	
		GOMA PARA SOPORTE DE FLECHA CARDÁN EN POLIURETANO 9219 (USA BALERO 88508)	9209	
		SOPORTE PARA FLECHA CARDÁN EN POLIURETANO GOMA 9209 (INCLUYE BALERO 88508)	9219	
		GOMA PARA SOPORTE DE FLECHA CARDÁN DAI-219 (USA BALERO 88508)	DAI-209	
		SOPORTE PARA FLECHA CARDÁN GOMA 209 (INCLUYE BALERO 88508)	DAI-219	
		BALERO PARA SOPORTE DE FLECHA CARDÁN SOPORTES 219, 9219, DAI-219 Y DAI-421 GOMAS 209, 9209, DAI-209 Y 225	88508	
		96-03	SOPORTE PARA FLECHA CARDÁN GOMA 226 (USA BALERO 88509)	411
			GOMA PARA SOPORTE DE FLECHA CARDÁN EN POLIURETANO 9411 (BALERO 88508)	9226

GOMAS Y SOPORTES PARA FLECHA CARDÁN

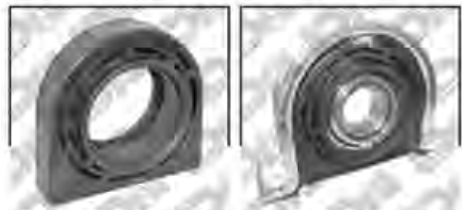

DAI-209

DAI-219

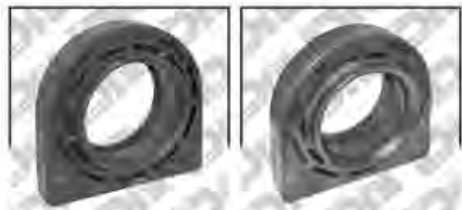

DAI-226

226

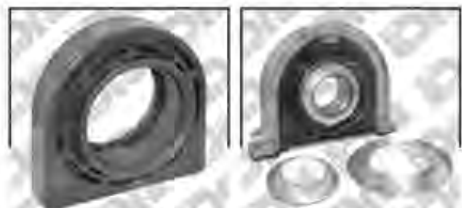

209

219

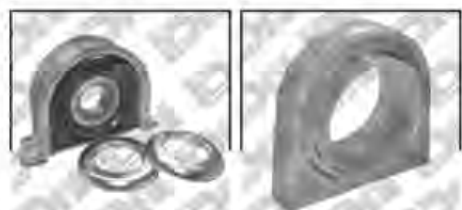

411

9209



9219

9226

88508



CONTINUACIÓN... ES-350

 	28	APLICACIÓN / DESCRIPTION	DAI PARTS #
--	----	--------------------------	-------------

GOMAS PARA SOPORTES DE FLECHA CARDÁN / SOPORTES COMPLETOS DE FLECHA CARDÁN

V8 5.4 V8 5.8	96-03	SOPORTE PARA FLECHA CARDÁN EN POLIURETANO GOMA 9226 (INCLUYE BALERO 88509)	9411
		GOMA PARA SOPORTE DE FLECHA CARDÁN 411 (USA BALERO 88509)	DAI-226
		SOPORTE PARA FLECHA CARDÁN GOMA 226 (INCLUYE BALERO 88509)	DAI-411
		BALERO PARA SOPORTE DE FLECHA CARDÁN SOPORTES 224, 414 Y DAI-416 GOMAS 207 Y 230	88107
		BALERO PARA SOPORTE DE FLECHA CARDÁN SOPORTES 411, 9411 Y DAI-411 GOMAS 226, 9226 Y DAI-226	88509

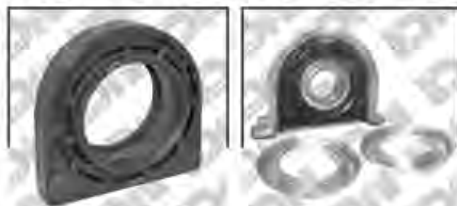
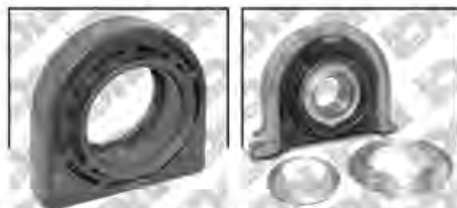
GOMAS Y SOPORTES PARA FLECHA CARDÁN

DAI-226
DAI-411

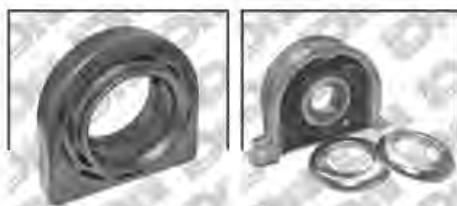
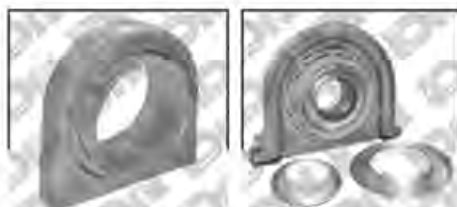
209
219

V8 6.9 V8 7.5	83-87	GOMA PARA SOPORTE DE FLECHA CARDÁN DAI-219 (USA BALERO 88508)	209
		SOPORTE PARA FLECHA CARDÁN GOMA 209 (USA BALERO 88508)	219
		GOMA PARA SOPORTE DE FLECHA CARDÁN 411 (USA BALERO 88509)	226
		SOPORTE PARA FLECHA CARDÁN GOMA 226 (USA BALERO 88509)	411
		GOMA PARA SOPORTE DE FLECHA CARDÁN EN POLIURETANO 9219 (USA BALERO 88508)	9209
		SOPORTE PARA FLECHA CARDÁN EN POLIURETANO GOMA 9209 (INCLUYE BALERO 88508)	9219
		GOMA PARA SOPORTE DE FLECHA CARDÁN EN POLIURETANO 9411 (USA BALERO 88508)	9226
		SOPORTE PARA FLECHA CARDÁN EN POLIURETANO GOMA 9226 (INCLUYE BALERO 88509)	9411

226
411

9209
9219

9226
9411

88107
88509

CONTINUACIÓN... ES-350

 		APLICACIÓN / DESCRIPTION	DAI PARTS #
GOMAS PARA SOPORTES DE FLECHA CARDÁN / SOPORTES COMPLETOS DE FLECHA CARDÁN			
V8 6.9 V8 7.5	83-87	GOMA PARA SOPORTE DE FLECHA CARDÁN DAI-219 (USA BALERO 88508)	DAI-209
		SOPORTE PARA FLECHA CARDÁN GOMA 209 (BALERO 88508)	DAI-219
		GOMA PARA SOPORTE DE FLECHA CARDÁN 411 (USA BALERO 88509)	DAI-226
		SOPORTE PARA FLECHA CARDÁN GOMA 226 (INCLUYE BALERO 88509)	DAI-411
		BALERO PARA SOPORTE DE FLECHA CARDÁN SOPORTE 224, 414, DAI-416 GOMAS 207 Y 230	88107
		BALERO PARA SOPORTE DE FLECHA CARDÁN SOPORTES 219, 9219, DAI-219 Y DAI-421 GOMAS 209, 9209, DAI-209 Y 225	88508
		BALERO PARA SOPORTE DE FLECHA CARDÁN SOPORTES 411, 9411 Y DAI-411 GOMAS 226, 9226 Y DAI-226	88509



MERCEDES BENZ

GOMAS PARA SOPORTE DE FLECHA CARDÁN / SOPORTES COMPLETO DE FECHA CARDÁN

SPRINTER

	28	APLICACIÓN / DESCRIPTION	DAI PARTS #
GOMAS PARA SOPORTES DE FLECHA CARDÁN / SOPORTES COMPLETOS DE FLECHA CARDÁN			
L4 2.1	03-09	SOPORTE PARA FLECHA CARDÁN	440

GOMAS Y SOPORTES PARA FLECHA CARDÁN



440

NISSAN

GOMAS PARA SOPORTE DE FLECHA CARDÁN / SOPORTES COMPLETO DE FECHA CARDÁN

D-21

	28	APLICACIÓN / DESCRIPTION	DAI PARTS #
GOMAS PARA SOPORTES DE FLECHA CARDÁN / SOPORTES COMPLETOS DE FLECHA CARDÁN			
	94-10	GOMA PARA SOPORTE DE FLECHA CARDÁN (USA BALERO 88507)	225
		SOPORTE PARA FLECHA CARDÁN (SIN BALERO)	410
		SOPORTE PARA FLECHA CARDÁN (CON BALERO)	DAI-421
		BALERO PARA SOPORTE DE FLECHA CARDÁN SOPORTES 219, 9219, DAI-219 Y DAI-421 GOMAS 209, 9209, DAI-209 Y 225	88508

GOMAS Y SOPORTES PARA FLECHA CARDÁN



DAI-421



225



410



88508



CONTINUACIÓN... D-21

  28		APLICACIÓN / DESCRIPTION	DAI PARTS #
GOMAS PARA SOPORTES DE FLECHA CARDÁN / SOPORTES COMPLETOS DE FLECHA CARDÁN			
L4 2.4	93-02	GOMA PARA SOPORTE DE FLECHA CARDÁN 224, 414 Y DAI-416 (USA BALERO 88107)	207
		SOPORTE PARA FLECHA CARDÁN GOMAS 207 Y 230 (INCLUYE BALERO 88107)	224
		GOMA PARA SOPORTE DE FLECHA CARDÁN 224, 414 Y DAI-416 (USA BALERO 88107)	230
		SOPORTE PARA FLECHA CARDÁN GOMAS 207 Y 230 (INCLUYE BALERO 88107)	414
		SOPORTE PARA FLECHA CARDÁN GOMAS 207 Y 230 (CON BALERO 88107)	DAI-416
		BALERO PARA SOPORTE DE FLECHA CARDÁN SOPORTES 224, 414 Y DAI-416 GOMAS 207 Y 230	88107

GOMAS Y SOPORTES PARA FLECHA CARDÁN



PICK UP

GOMAS PARA SOPORTES DE FLECHA CARDÁN / SOPORTES COMPLETOS DE FLECHA CARDÁN			
L4 1.8	83-93	GOMA PARA SOPORTE DE FLECHA CARDÁN 224, 414 Y DAI-416 (USA BALERO 88107)	207
L4 1500	75-92		
L4 1600	75-92	SOPORTE PARA FLECHA CARDÁN GOMAS 207 Y 230 (INCLUYE BALERO 88107)	224

GOMAS Y SOPORTES PARA FLECHA CARDÁN



CONTINUACIÓN... PICK UP

 		APLICACIÓN / DESCRIPTION	DAI PARTS #
GOMAS PARA SOPORTES DE FLECHA CARDÁN / SOPORTES COMPLETOS DE FLECHA CARDÁN			
L4 1.8 L4 1500 L4 1600	83-93	GOMA PARA SOPORTE DE FLECHA CARDÁN 224, 414 Y DAI-416 (USA BALERO 88107)	230
	75-92	SOPORTE PARA FLECHA CARDÁN GOMAS 207 Y 230 (INCLUYE BALERO 88107)	414
	75-92	SOPORTE PARA FLECHA CARDÁN GOMAS 207 Y 230 (CON BALERO 88107)	DAI-416
		BALERO PARA SOPORTE DE FLECHA CARDÁN SOPORTES 224, 414 Y DAI-416 GOMAS 207 Y 230	88107
L4 1800	83-92	SOPORTE PARA FLECHA CARDÁN GOMAS 207 Y 230 (INCLUYE BALERO 88107)	224
		GOMA PARA SOPORTE DE FLECHA CARDÁN 224, 414 Y DAI-416 (USA BALERO 88107)	230
		SOPORTE PARA FLECHA CARDÁN GOMAS 207 Y 230 (INCLUYE BALERO 88107)	414
		SOPORTE PARA FLECHA CARDÁN GOMAS 207 Y 230 (CON BALERO 88107)	DAI-416
	83-93	BALERO PARA SOPORTE DE FLECHA CARDÁN SOPORTES 224, 414 Y DAI-416 GOMAS 207 Y 230	88107
GOMA PARA SOPORTE DE FLECHA CARDÁN 224, 414 Y DAI-416 (USA BALERO 88107)		207	

GOMAS Y SOPORTES PARA FLECHA CARDÁN

DAI-416

207

224

230

414

88107

MEDIDAS DE GOMAS Y SOPORTES / CENTER SUPPORT
GOMAS PARA SOPORTE DE FLECHA CARDAN / SOPORTE COMPLETO DE FLECHA CARDAN

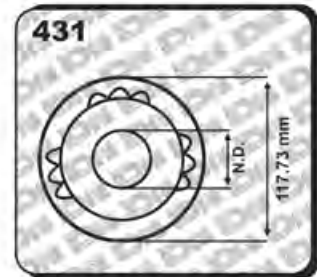
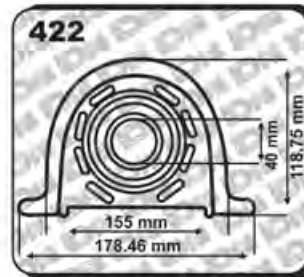
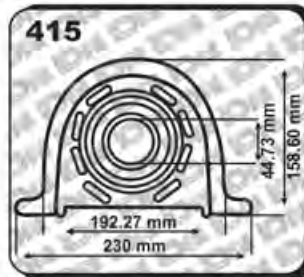
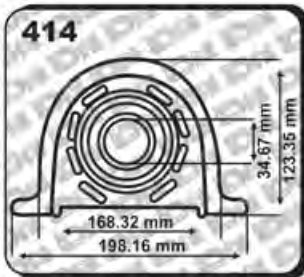
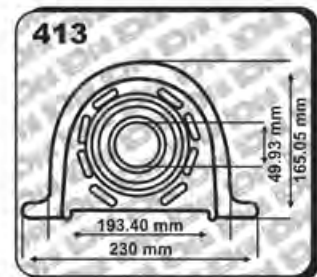
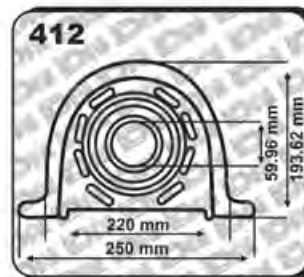
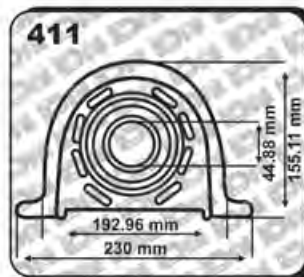
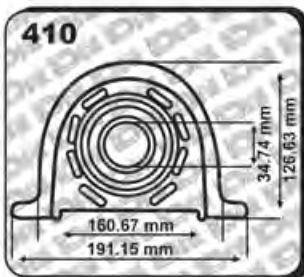
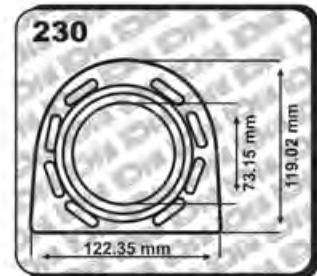
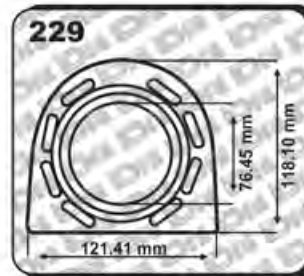
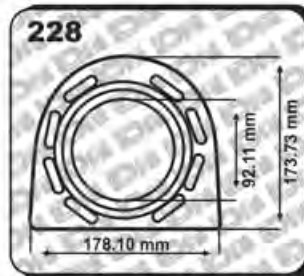
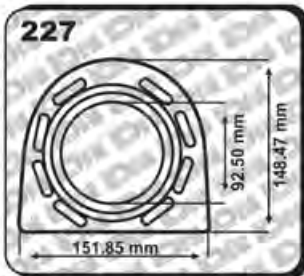
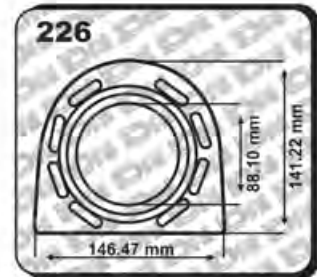
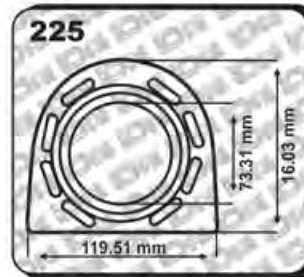
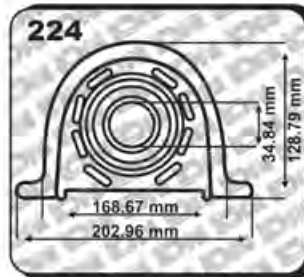
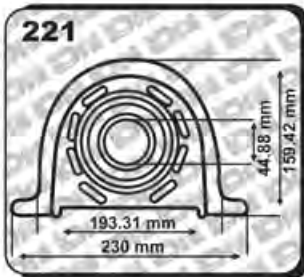
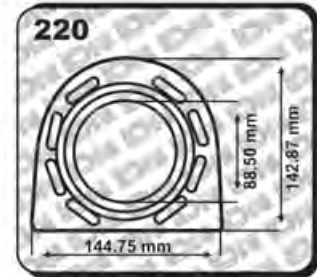
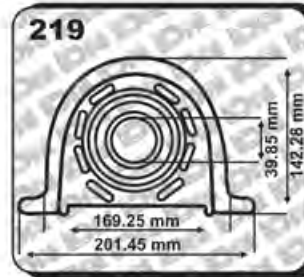
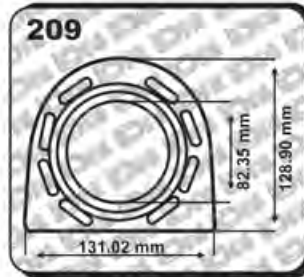
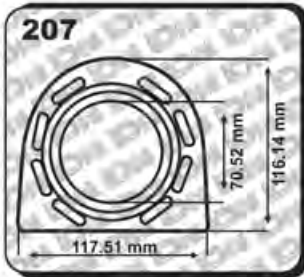

NOTA: Las medidas son en mm, son aproximadas y pueden variar en +/- %



965 IMPORTANTE: Identifica nuestro producto con el grabado del logo No aceptes imitaciones.



MEDIDAS DE GOMAS Y SOPORTES / CENTER SUPPORT

GOMAS PARA SOPORTE DE FLECHA CARDAN / SOPORTE COMPLETO DE FLECHA CARDAN

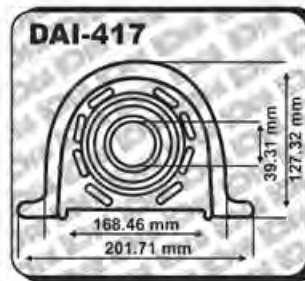
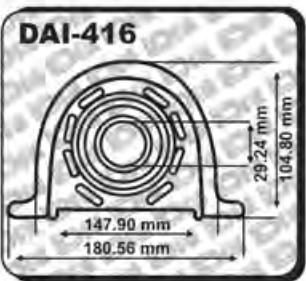
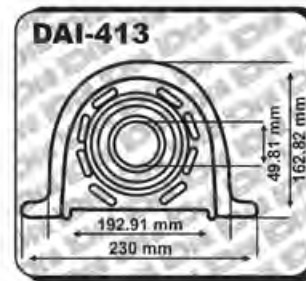
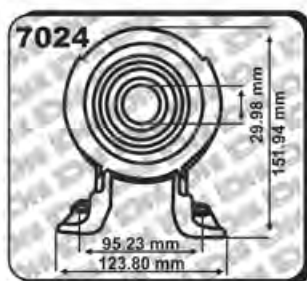
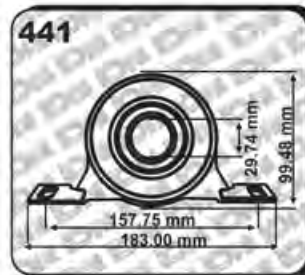
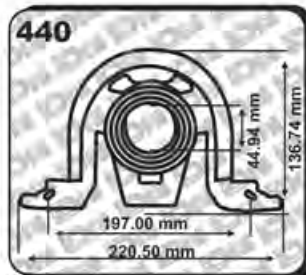
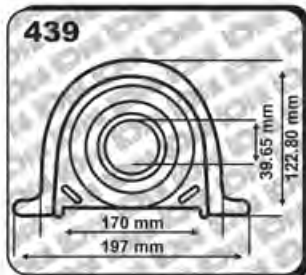
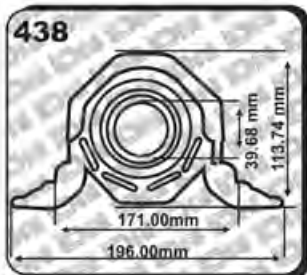

<p>D-015</p> <p>TOPE DEL. IZQ. Y DER. CHRYSLER VOYAGER VW GOL, POINTER, SAVEIRO</p>	<p>D-022</p> <p>TOPE DEL. IZQ. Y DER. CHEVROLET VECTRA</p>	<p>D-037</p> <p>TOPE DEL. IZQ. Y DER. CHEVROLET ASTRA, CHEVY CORSA, MERIVA, TIGRA</p>	<p>D-038</p> <p>TOPE TRASERO IZQ. Y DER. CHEVROLET CHEVY. CORSA MONZA, TIGRA, TORNADO</p>	<p>D-050</p> <p>TOPE TRASERO IZQ. Y DER. FORD ESCORT, FIESTA, KA SEAT CORDOBA, IBIZA VW GOLF II Y III, JETTA II Y III</p>
<p>D-054</p> <p>TOPE FRONTAL IZQ. Y DER. CHEVROLET CHEVY C2, CORSA</p>	<p>D-067</p> <p>TOPE FRONTAL IZQ. Y DER. FORD FIESTA</p>	<p>D-071</p> <p>TOPE TRASERO IZQ. Y DER. VW GOL, POINTER POINTER PICK UP, SAVEIRO</p>	<p>D-074</p> <p>TOPE FRONTAL IZQ. Y DER. AUDI A3, VW GOLF III, JETTA TOPE TRAS. IZQ. Y DER. FORD ESCORT</p>	<p>D-097</p> <p>TOPE FRONTAL IZQ. Y DER. FORD MONDEO</p>
<p>D-142, D-142-C</p> <p>TOPE FRONTAL IZQ. Y DER. CHEVROLET BLAZER, S-10</p>	<p>D-0619</p> <p>TOPE FRONTAL IZQ. Y DER. CHYRSLER 300M, ARIES PONTIAC SUNFIRE TOPE TRAS. IZQ. Y DER. FORD SABLE, CHEV. GRAND AM</p>	<p>D-0620</p> <p>TOPE TRAS. IZQ. Y DER. CHRYSLER NEON, VAN TOPE DEL. IZQ Y DER. FORD FAIRMONT, MUSTANG</p>	<p>D-0621</p> <p>TOPE FRON. TRAS. IZQ. Y DER. BUICK LACROSSE, FORD MUSTANG, NISSAN MAXIMA CHEVROLET CAMARO</p>	<p>D-0622</p> <p>TOPE FRONTAL IZQ. Y DER. BUICK REGAL, SKYHAWK BUICK, CADILLAC, CHRYSLER CHEVROLET, FORD, NISSAN</p>
<p>DAI-015-KIT</p> <p>TOPES P/AMORT. Y CUBRE POLVO FRONTAL IZQ. Y DER. VW POINTER POINTER, PICK UP, GOL</p>	<p>DAI-016-KIT</p> <p>TOPES P/AMORT. Y CUBRE POLVO FRONTAL IZQ. Y DER. HYUNDAI i10</p>	<p>DAI-050-KIT</p> <p>TOPES P/AMORT. Y CUBRE POLVO TRASERO IZQ. Y DER. FORD FIESTA, IKON</p>	<p>DAI-054-KIT</p> <p>TOPES P/AMORT. Y CUBRE POLVO FRONTAL IZQ. Y DER. CHEVROLET CHEVY CORSA</p>	<p>DAI-067-KIT</p> <p>TOPES P/AMORT. Y CUBRE POLVO FRONTAL IZQ. Y DER. FORD FIESTA, IKON</p>
<p>DAI-071-KIT</p> <p>TOPES P/AMORT. Y CUBRE POLVO TRASERO IZQ. Y DER. VW POINTER, PICK UP, GOL</p>	<p>DAI-074-KIT</p> <p>TOPES P/AMORT. Y CUBRE POLVO FRONTAL IZQ. Y DER. VW BEETLE GOLF II, GOLF IV, JETTA II</p>	<p>DAI-209</p> <p>GOMA PARA SOPORTE FLECHA CARDAN DAI-219 CHEVROLET DENALI CHRYSLER D-150</p>	<p>DAI-219</p> <p>SOP. PARA FLECHA CARDAN CON BALERO 88508 CHEV. DENALI, CHRYSLER D-150</p>	<p>DAI-226</p> <p>GOMA PARA SOPORTE FLECHA CARDAN 411 CON BALERO 88509 CHEVROLET C-15, C-1500</p>
<p>DAI-411</p> <p>SOP. PARA FLECHA CARDAN GOMA 226, CON BALERO 88509 CHEVROLET C-15, C-1500</p>	<p>DAI-416</p> <p>SOP. PARA FLECHA CARDAN GOMAS 230 Y 270 BALERO 88017 CHEVROLET BLAZER</p>	<p>DAI-421</p> <p>SOP. PARA FLECHA CARDAN CON BALERO 88508 NISSAN D-21</p>	<p>DAI-1403005</p> <p>BUJE P/HORQUILLA GRANDE BUICK, CHEVROLET OLDSMOBILE, PONTIAC</p>	<p>DAI-1403006</p> <p>BUJE P/HORQUILLA CHICO BUICK, CHEVROLET OLDSMOBILE, PONTIAC</p>



DAI-1403007  BUJE P/HORQUILLA CHEVROLET CORSA, MERIVA, TORNADO	DAI-1403007-R  BUJE P/ HORQUILLA REFORZADO CHEVROLET CORSA, MERIVA, TORNADO	DAI-1403010  BUJE P/HORQUILLA SUP. CHEVROLET TRAIL BLAZER	DAI-1403011  BUJE P/HORQUILLA INF. GDE. CHEVROLET TRACKER	DAI-1403012  BUJE P/HORQUILLA INF. CHICO CHEVROLET TRACKER
DAI-1403013  BUJE P/HORQUILLA INF. CHICO CHEVROLET TRAIL BLAZER	DAI-1403014  BUJE P/HORQUILLA INF. GDE. CHEVROLET TRAIL BLAZER	DAI-1403019  BUJE PARA HORQUILLA INFERIOR CHICO CHEVROLET EQUINOX TORRENT	DAI-1403021  BUJE PARA HORQUILLA INF. GRANDE CHEVROLET OPTRA	DAI-1403022  BUJE P/HORQUILLA INF. GDE. CHEVROLET EQUINOX
DAI-1403023  BUJE P/HORQUILLA INF. GDE. CHEVROLET, AVEO PONTIAC G3	DAI-1403024  BUJE P/ HORQUILLA CHICO CHEVROLET AVEO PONTIAC G3	DAI-1403046  BUJE PARA EJE TRASERO CHEVROLET CORSA	DAI-1406006  BUJE PARA HORQUILLA CHICO, HYUNDAI ATOS	DAI-1406012  BUJE P/HORQUILLA GDE. CARAVAN, GRAND CARAVAN GRAND VOYAGER
DAI-1406013  BUJE PARA HORQUILLA GRANDE, HYUNDAI ATOS	DAI-1406014  BUJE P/HORQUILLA GDE. CHRYSLER CARAVAN GRAND CARAVAN	DAI-1406030  BUJE P/HORQUILLA INF. CHICO HYUNDAI ACCENT, KIA RIO	DAI-1406031  BUJE P/HORQUILLA INF. GDE. HYUNDAI ACCENT, KIA RIO	DAI-1406036  BUJE PARA HORQUILLA SUP. CHRYSLER RAM JEEP WRANGLER
DAI-1406048  BUJE P/HORQUILLA INF. CHICO CHRYSLER AVENGER JOURNEY Y TOWN COUNTRY	DAI-1406055  BUJE P/HORQUILLA INF. GRANDE CHRYSLER AVENGER JOURNEY Y TOWN COUNTRY	DAI-1406065  GOMA PARA BARRA ESTABILIZADORA HYUNDAI ATOS	DAI-1406068  BUJE PARA HORQUILLA INF. TRASERO JEEP NITRO, LIBERTY	DAI-1406088  BUJE INFERIOR CHICO HYUNDAI VERNA
DAI-1406089  BUJE P/HORQUILLA INF. GDE. HYUNDAI ACCENT, VERNA	DAI-1406091  BUJE PARA HORQUILLA INF. CHRYSLER CHARGER CHALLENGER, 300, 300C	DAI-1406120  BUJE PARA EJE TRASERO HYUNDAI ATOS	DAI-1408007  BUJE PARA HORQUILLA GDE. FORD ESCAPE, MARINER TRIBUTE	DAI-1408016  BUJE P/HORQUILLA GDE. FORD FIESTA ECOSPORT, IKON

<p>DAI-1408017</p> <p>BUJE PARA HORQUILLA CHICO, FORD ECOSPORT</p>	<p>DAI-1408033</p> <p>BUJE PARA HORQUILLA GRANDE, FORD KA</p>	<p>DAI-1408034</p> <p>BUJE PARA HORQUILLA CHICO, FORD KA</p>	<p>DAI-1408040</p> <p>BUJES PARA HORQUILLA SUP. EXPEDITION, F-150, LOBO NAVIGATOR</p>	<p>DAI-1408057</p> <p>BUJE PARA HORQUILLA INF. GRANDE FORD FOCUS, MAZDA 3 Y 6</p>
<p>DAI-1408063</p> <p>BUJE PARA HORQUILLA CHICO FORD ESCAPE, TRIBUTE MARINER</p>	<p>DAI-1408066</p> <p>BUJE PARA HORQUILLA INF. (CURVA) FORD FUSION, MAZDA 6</p>	<p>DAI-1408067</p> <p>BUJE PARA HORQUILLA INF. (INT. AL AMORTIGUADOR) FORD FUSION, MAZDA 6</p>	<p>DAI-1409005</p> <p>BUJE PARA HORQUILLA INF. GRANDE, ACURA MDX HONDA ODYSSEY, PILOT</p>	<p>DAI-1409006</p> <p>BUJE PARA HORQUILLA INF. CHICO, ACURA MDX HONDA ODYSSEY, PILOT</p>
<p>DAI-1409010</p> <p>BUJE PARA HORQUILLA INFERIOR CHICO HONDA FIT</p>	<p>DAI-1409012</p> <p>BUJE PARA HORQUILLA INFERIOR GRANDE HONDA ACCORD</p>	<p>DAI-1409018 <i>NUEVO</i></p> <p>BUJE PARA HORQUILLA INF. GRANDE HONDA CIVIC CR-V, CR-X, ELEMENT</p>	<p>DAI-1409020 <i>NUEVO</i></p> <p>BUJE PARA HORQUILLA INF. CHICO HONDA CIVIC, CR-X</p>	<p>DAI-1409026 <i>NUEVO</i></p> <p>GOMA PARA BARRA ESTAB. (2) HONDA CIVIC</p>
<p>DAI-1415001</p> <p>BUJE HORQUILLA INF. CHICO CHRYSLER, JEEP, MITSUBISHI</p>	<p>DAI-1415002</p> <p>BUJE P/HORQUILLA GDE. CHRYSLER, JEEP, MITSUBISHI</p>	<p>DAI-1416003</p> <p>BUJE P/ HORQUILLA CHICO NISSAN SENTRA, ALMERA</p>	<p>DAI-1416004</p> <p>BUJE P/ HORQUILLA GRANDE NISSAN SENTRA, AMERA</p>	<p>DAI-1416007</p> <p>BUJE P/HORQUILLA INF. CHICO NISSAN, RENAULT</p>
<p>DAI-1416009</p> <p>BUJE P/HORQUILLA INF. GDE. NISSAN, CUBE, MICRA, TIIDA VERSA</p>	<p>DAI-1416019</p> <p>GOMA PARA BARRA ESTABILIZADORA NISSAN ALMERA, SENTRA</p>	<p>DAI-1416020</p> <p>GOMA P/BARRA ESTABILIZADORA NISSAN PLATINA, CLIO</p>	<p>DAI-1416021 <i>NUEVO</i></p> <p>BUJE PARA EJE TRASERO NISSAN PLATINA RENAULT CLIO, KANGOO</p>	<p>DAI-1416023</p> <p>BUJE PARA HORQUILLA INF. CHICO NISSAN X-TRAIL</p>
<p>DAI-1416042 <i>NUEVO</i></p> <p>BUJE PARA HORQUILLA CHICO NISSAN MARCH, NOTE, VERSA</p>	<p>DAI-1416043 <i>NUEVO</i></p> <p>BUJE PARA HORQUILLA GRANDE, NISSAN MARCH, NOTE, VERSA</p>	<p>DAI-1416053</p> <p>BUJE PARA EJE TRASERO NISSAN SENTRA</p>	<p>DAI-1416059</p> <p>BUJE PARA HORQUILLA INF. GRANDE (SIN SOPORTE) NISSAN ALTIMA, MAXIMA</p>	<p>DAI-1419002</p> <p>BUJE P/HORQUILLA INF. GDE. RENAULT, CLIO, MEGANE II</p>



DAI-1425010 BUJE PARA HORQUILLA INFERIOR CHICO TOYOTA CAMRY	DAI-1425023 <small>NUEVO</small> BUJE PARA HORQUILLA SUP. CHICO TOYOTA HIACE	DAI-1425026 BUJE PARA HORQUILLA SUPERIOR (4X2) TOYOTA TACOMA	DAI-1425027 BUJE PARA HORQUILLA INFERIOR (4X2) TOYOTA TACOMA	DAI-1426001 BUJE P/BARRA DE DIRECCIÓN VW POINTER, PICK UP
DAI-1426003 BUJE P/HORQUILLA INFERIOR CHICO, SEAT CORDOBA IBIZA, VW CROSSFOX	DAI-1426005 BUJE SUPERIOR GRANDE VW EUROVAN TRANSPORTER	DAI-1426006 BUJE SUPERIOR CHICO VW EUROVAN, TRANSPORTER	DAI-1426011 BUJE P/HORQUILLA INF. CHICO AUDI, SEAT, VW	DAI-1426020 <small>NUEVO</small> BUJE PARA HORQUILLA AUDI A4, A6, VW PASSAT
DAI-1426023 BUJE PARA HORQUILLA INF. GRANDE GOLF VII VW JETTA VI BICENTENARIO	DAI-1426037 <small>NUEVO</small> BUJE PARA EJE TRASERO IZQ. Y DER., AUDI A3, TT SEAT CORDOBA, IBIZA, LEON VW LUPO, POLO VENTO	DAI-1508086 <small>NUEVO</small> BUJES PARA HORQUILLA TRASERA SUPERIOR FORD EDGE, LINCOLN MKZ	DAI-1509015 BRAZO COMPENSADOR TRASERO, HONDA CIVIC	DAI-1509045 BUJES PARA HORQUILLA SUP. TRASERA HONDA CIVIC
DAI-15851956 TORNILLO ESTABILIZADOR BUICK, CHEVROLET PONTIAC, SATURN	DAI-2103001 TORNILLO ESTABILIZADOR CHEVROLET TORNADO PONTIAC G4	DAI-2103009 TORNILLO ESTABILIZADOR CADILLAC BLS CHEVROLET VECTRA	DAI-2103011 TORNILLO ESTABILIZADOR TRASERO CHEVROLET OPTRA	DAI-2103013 TORNILLO ESTABILIZADOR FRONTAL CHEVROLET OPTRA
DAI-2106001 TORNILLO ESTABILIZADOR FRONTAL IZQUIERDO HYUNDAI ACCENT, VERNA	DAI-2106002 TORNILLO ESTABILIZADOR FRONTAL DERECHO HYUNDAI ACCENT, VERNA	DAI-2106006 TORNILLO ESTABILIZADOR FRONTAL CHRYSLER NEON, PT CRUISER	DAI-2106008 TORNILLO ESTABILIZADOR FRONTAL CHRYSLER 300-M	DAI-2106015 TORNILLO ESTABILIZADOR FRONTAL HYUNDAI ATOS
DAI-2106016 TORNILLO ESTABILIZADOR CHRYSLER AVENGER JEEP PATRIOT, MAZDA	DAI-2106017 TORNILLO EST. FRONTAL CHRYSLER GRAND CARAVAN VW ROUTAN	DAI-2106021 TORNILLO ESTABILIZADOR FRONTAL IZQUIERDO HYUNDAI ACCENT, ATTITUDE	DAI-2106022 TORNILLO ESTABILIZADOR FRONTAL DERECHO HYUNDAI ACCENT, ATTITUDE	DAI-2108001 TORNILLO ESTABILIZADOR FRONTAL (CORTO) FORD COURIER HYUNDAI I10

<p>DAI-2108002</p> <p>TORNILLO ESTABILIZADOR FRONTAL FORD ESCAPE MERCURY MARINER</p>	<p>DAI-2108003</p> <p>TORNILLO ESTABILIZADOR TRASERO FORD MONDEO</p>	<p>DAI-2108004</p> <p>TORNILLO ESTABILIZADOR FRONTAL FORD ESCAPE MAZDA TRIBUTE</p>	<p>DAI-2108005</p> <p>TORNILLO ESTABILIZADOR FRONTAL FORD MONDEO JAGUAR X-TYPE</p>	<p>DAI-2109001</p> <p>TORNILLO ESTABILIZADOR FRONTAL ACURA CL, TL HONDA CIVIC, CR-X</p>
<p>DAI-2109002</p> <p>TORNILLO ESTABILIZADOR DERECHO ACURA CL, HONDA ACCORD</p>	<p>DAI-2109003</p> <p>TORNILLO ESTABILIZADOR IZQUIERDO ACURA CL, HONDA ACCORD</p>	<p>DAI-2109006</p> <p>TORNILLO ESTABILIZADOR DERECHO HONDA CIVIC, CR-V</p>	<p>DAI-2109007</p> <p>TORNILLO ESTABILIZADOR IZQUIERDO HONDA CIVIC, CR-V</p>	<p>DAI-2109010</p> <p>TORNILLO ESTABILIZADOR TRASERO DERECHO HONDA CR-V</p>
<p>DAI-2109011</p> <p>TORNILLO ESTABILIZADOR TRASERO IZQUIERDO HONDA CR-V</p>	<p>DAI-2109013</p> <p>TORNILLO ESTABILIZADOR FRONTAL IZQUIERDO HONDA ACCORD</p>	<p>DAI-2109016</p> <p>TORNILLO ESTABILIZADOR FRONTAL DERECHO HONDA FIT</p>	<p>DAI-2109017</p> <p>TORNILLO ESTABILIZADOR FRONTAL IZQUIERDO HONDA FIT</p>	<p>DAI-2109020</p> <p>TORNILLO ESTABILIZADOR TRASERO HONDA FIT</p>
<p>DAI-2109021</p> <p>TORNILLO ESTABILIZADOR FRONTAL IZQUIERDO HONDA CIVIC</p>	<p>DAI-2109022</p> <p>TORNILLO ESTABILIZADOR FRONTAL DERECHO HONDA CIVIC, CR-X</p>	<p>DAI-2109023</p> <p>TORNILLO ESTABILIZADOR FRONTAL IZQ. Y DER. HONDA CR-V, RDX</p>	<p>DAI-2109024</p> <p>TORNILLO ESTABILIZADOR TRASERO DERECHO HONDA CR-V</p>	<p>DAI-2109025</p> <p>TORNILLO ESTABILIZADOR TRASERO IZQUIERDO HONDA CR-V</p>
<p>DAI-2109028</p> <p>TORNILLO ESTABILIZADOR TRASERO DER. ACURA IL-X HONDA CIVIC, CR-X</p>	<p>DAI-2109029</p> <p>TORNILLO ESTABILIZADOR TRASERO IZQ. ACURA IL-X HONDA CIVIC, CR-X</p>	<p>DAI-2113001</p> <p>TORNILLO ESTABILIZADOR FRONTAL FORD FOCUS, MAZDA 3 VOLVO S-40</p>	<p>DAI-2113004</p> <p>TORNILLO ESTABILIZADOR FRONTAL DERECHO MAZDA 6</p>	<p>DAI-2113005</p> <p>TORNILLO ESTABILIZADOR TRASERO FORD FUSION, MAZDA 6</p>
<p>DAI-2115001</p> <p>TORNILLO ESTABILIZADOR FRONTAL IZQUIERDO CHRYSLER CIRRUS MITSUBISHI GALANT</p>	<p>DAI-2115002</p> <p>TORNILLO ESTABILIZADOR FRONTAL DERECHO CHRYSLER CIRRUS MITSUBISHI GALANT</p>	<p>DAI-2115005</p> <p>TORNILLO ESTABILIZADOR FRONTAL MITSUBISHI OUTLANDER</p>	<p>DAI-2115006</p> <p>TORNILLO ESTABILIZADOR FRONTAL MITSUBISHI LANCER</p>	<p>DAI-2115007</p> <p>TORNILLO ESTABILIZADOR TRASERO IZQUIERDO MITSUBISHI OUTLANDER</p>

































DAI-2115008  TORNILLO ESTABILIZADOR TRASERO DERECHO MITSUBISHI OUTLANDER	DAI-2116004  TORNILLO ESTABILIZADOR FRONTAL DERECHO NISSAN MAXIMA	DAI-2116005  TORNILLO ESTABILIZADOR FRONTAL IZQUIERDO NISSAN MAXIMA	DAI-2116009  TORNILLO ESTABILIZADOR FRONTAL IZQUIERDO NISSAN X-TRAIL	DAI-2116010  TORNILLO ESTABILIZADOR FRONTAL DERECHO NISSAN X-TRAIL
DAI-2116012  TORNILLO ESTABILIZADOR FRONTAL DERECHO NISSAN MURANO	DAI-2116013  TORNILLO ESTABILIZADOR FRONTAL IZQUIERDO NISSAN MURANO	DAI-2116018  TORNILLO ESTABILIZADOR FRONTAL NISSAN SENTRA	DAI-2116019  TORNILLO ESTABILIZADOR FRONTAL NISSAN CUBE, TIDA, VERSA	DAI-2116024  TORNILLO ESTABILIZADOR FRONTAL DERECHO NISSAN QUEST MERCURY VILLAGER
DAI-2116025  TORNILLO ESTABILIZADOR FRONTAL IZQUIERDO NISSAN QUEST MERCURY VILLAGER	DAI-2116028  TORNILLO ESTABILIZADOR TRASERO NISSAN, FRONTIER, X-TERRA	DAI-2117001  TORNILLO ESTABILIZADOR FRONTAL PEUGEOT 206, 207 COMPACT	DAI-2117002  TORNILLO ESTABILIZADOR FRONTAL PEUGEOT 307, 308	DAI-2117003  TORNILLO ESTABILIZADOR PEUGEOT 306
DAI-2117007  TORNILLO ESTABILIZADOR TRASERO PEUGEOT 407	DAI-2119001  TORNILLO ESTABILIZADOR FRONTAL RENAULT LAGUNA, TRAFIC	DAI-2124001  TORNILLO ESTABILIZADOR FRONTAL IZQ. Y DER. SUZUKI AEIRO, KIZASHI	DAI-2124002  TORNILLO ESTABILIZADOR SUZUKI AEIRO	DAI-2124003  TORNILLO ESTABILIZADOR SUZUKI SWIFT
DAI-2125001  TORNILLO ESTABILIZADOR TRASERO TOYOTA CAMRY, HIGHLANDER	DAI-2125002  TORNILLO ESTABILIZADOR FRONTAL TOYOTA RAV-4	DAI-2125008  TORNILLO ESTABILIZADOR FRONTAL TOYOTA COROLLA, MATRIX	DAI-2125009  TORNILLO ESTABILIZADOR FRONTAL TOYOTA CAMRY, HIGHLANDER, SIENNA	DAI-2125013  TORNILLO ESTABILIZADOR TRASERO TOYOTA 4 RUNNER, FJ CRUISER
DAI-2125019  TORNILLO ESTABILIZADOR FRONTAL TOYOTA YARIS	DAI-2126002  TORNILLO ESTABILIZADOR FRONTAL DERECHO AUDI A3, SEAT LEON VW GOLF A4	DAI-2126003  TORNILLO ESTABILIZADOR FRONTAL SEAT ALHAMBRA, VW SHARAN	DAI-2126004  TORNILLO ESTABILIZADOR FRONTAL AUDI A1, SEAT IBIZA, VW GOL	DAI-2126005  TORNILLO ESTABILIZADOR FRONTAL IZQ. Y DER. SEAT IBIZA, CORDOBA VW DERBY

<p>DAI-2126010</p>  <p>TORNILLO ESTABILIZADOR SEAT ALTEA</p>	<p>DAI-2126013</p>  <p>TORNILLO ESTABILIZADOR FRONTAL VW EUROVAN TDI, TRANSPORTER</p>	<p>DAI-2906208</p>  <p>BUJE PARA SOPORTE DE DIFERENCIAL CHRYSLER DURANGO JEEP GRAND CHEROKEE COMMANDER</p>	<p>DAI-352364</p>  <p>BUJE PARA HORQUILLA INF. CHEVROLET ASTRA, MALIBU PONTIAC G5, SAAB 9-3</p>	<p>DAI-352365</p>  <p>BUJE INFERIOR CHEVROLET ASTRA, ZAFIRA</p>
<p>DAI-352376</p>  <p>BUJE PARA HORQUILLA INF. CHICO PEUGEOT 206, 207 COMPAC</p>	<p>DAI-352377</p>  <p>BUJE PARA HORQUILLA INF. GRANDE PEUGEOT 206, 207, COMPAC, 307, 308 PARTNER TAPEE</p>	<p>DAI-4616939</p>  <p>BUJE P/HORQUILLA INF. CHICO CHRYSLER CIRRUS, SEBRING, STRATUS</p>	<p>DAI-4689120</p>  <p>BUJE P/HORQUILLA INF. CHICO CHRYSLER, CARAVAN GRAND CARAVAN, PACIFICA</p>	<p>DAI-48655-07010</p>  <p>BUJE P/HORQUILLA GDE. TOYOTA CAMRY</p>
<p>DAI-5039013</p>  <p>GOMAS PARA BARRA ESTAB. FRONTAL IZQ. Y DER. HONDA CR-V</p>	<p>DAI-51370S04-G00</p>  <p>BUJE PARA HORQUILLA INFERIOR GRANDE HONDA CIVIC, CR-V, CR-X</p>	<p>DAI-5272250</p>  <p>BUJE P/HORQUILLA INF. GDE. CHRYSLER NEON PT CRUISER</p>	<p>DAI-5272252</p>  <p>BUJE P/HORQUILLA INF. CHICO CHRYSLER NEON, PT CRUISER</p>	<p>DAI-54423-B9500</p>  <p>BUJE INFERIOR NISSAN D21-PICK UP</p>
<p>DAI-54560-0B000</p>  <p>BUJE PARA HORQUILLA INF. CHICO NISSAN QUEST MERCURY VILLAGER</p>	<p>DAI-54570-0E010</p>  <p>BUJE INFERIOR GRANDE NISSAN ALTIMA, MAXIMA</p>	<p>DAI-54570-6B010</p>  <p>BUJE P/HORQUILLA GDE. MERCURY, NISSAN</p>	<p>DAI-54590-01E00</p>  <p>BUJE P/HORQUILLA CHICO NISSAN, ALTIMA, MAXIMA</p>	<p>DAI-54618-0Z800</p>  <p>TORNILLO ESTABILIZADOR NISSAN ALTIMA, MAXIMA</p>
<p>DAI-55045-60Y00</p>  <p>BUJE P/ARTICULACION TRASERA NISSAN TSURU III</p>	<p>DAI-55152-50A10</p>  <p>BUJE P/TIRANTE TRASERO NISSAN TSURU III</p>	<p>DAI-7055</p>  <p>BRAZO AUX. DE DIRECCION DODGE D100, D200, D350 Y RAM CHARGER 4X2</p>	<p>DAI-7700-424-399</p>  <p>BUJE PARA HORQUILLA INF. NISSAN PLATINA RENAULT CLIO, KANGOO</p>	<p>DAI-90217845</p>  <p>BUJE TRASERO CHEVROLET CHEVY MONZA, PICK UP</p>
<p>DAI-90445097</p>  <p>BUJE PARA HORQUILLA CHEVROLET CHEVY TORNADO</p>	<p>DAI-90445098</p>  <p>BUJE PARA BARRA TENSORA CHEVROLET CHEVY, MONZA</p>	<p>DAI-93BB-3B-438CA</p>  <p>TORNILLO ESTABILIZADOR FORD COUGAR, CONTOUR</p>	<p>DAI-96FB-3063-AA</p>  <p>BUJE P/HORQUILLA CHICO FORD COURIER, FIESTA</p>	<p>DAI-96FB-3A-262</p>  <p>BUJE P/HORQUILLA GRANDE FORD COURIER FIESTA, IKON</p>



DAI-191-407-182 BUJE P/HOQUILLA CHICO AUDI, SEAT, VW	DAI-1H0-411-315 TORNILLO ESTABILIZADOR FRONTAL VW GOLF A3, JETTA A3	DAI-1J0-411-315-C TORNILLO ESTABILIZADOR SEAT TOLEDO VW BEETLE, GOLF A4	DAI-1J0-501-541 BUJE PARA EJE TRASERO SEAT IBIZA VW GOLF, JETTA, POLO, LUPO	DAI-B455-34-46XA BUJE DE PUNTA CON ABRAZ, DERECHO FORD ESCORT
DAI-B455-34-46YA BUJE DE PUNTA CON ABRAZ, IZQUIERDO, FORD ESCORT	DAI-K-8702 TORNILLO ESTABILIZADOR FORD FREESTAR	DAI-K-3167-A BUJE INFERIOR JEEP GRAN CHEROKEE LIBERTY	DAI-K-3174 TORNILLO ESTABILIZADOR FRONTAL JEEP CHEROKEE, COMANCHE	DAI-K-3196 TORNILLO ESTABILIZADOR FRONTAL JEEP CHEROKEE, COMANCHE
DAI-K-6283 BUJES PARA HORQUILLA SUPERIOR (4X4) S-10, S-14, BLAZER, JIMMY	DAI-K-6323 BUJES PARA HORQUILLA SUP. CHEVROLET BLAZER SUBURBAN	DAI-K-6395 BUJES PARA HORQUILLA SUP. CHEVROLET SUBURBAN SILVERADO, TAHOE	DAI-K-6578 BUJES PARA HORQUILLA CHEVROLET, OLDSMOBILE PONTIAC	DAI-K-7197 TORNILLO ESTABILIZADOR FRONTAL CHRYSLER CONCORDE, INTREPID
DAI-K-7258 TORNILLO ESTABILIZADOR FRONTAL CHRYSLER CARAVAN, GRAND CARAVAN	DAI-K-8300 BUJE PARA EJE (PARALELO) FORD E-100 VAM, F-100, F-150 F-250, F-350, MICROBUS	DAI-K-8417 BUJE P/HOQUILLA (BRAZO) INFERIOR EXTERIOR FORD ESCORT Zx2, TEMPO	DAI-K-8436 BUJE P/HOQUILLA INTERIOR INTERIOR (BRAZO) FORD ESCORT Zx2, GHIA	DAI-K-8452-A BUJE INFERIOR FORD TAURUS, WINDSTAR MERCURY SABLE
DAI-K-8645 BUJE PARA TIRANTE E-150 VAN, E-250 VAN, E-350 VAN, E-450 VAN, E-550 VAN	DAI-K-8702 TORNILLO ESTABILIZADOR FRONTAL FORD, FREESTAR, SABLE	DAI-K-8734 TORNILLO ESTABILIZADOR FRONTAL IZQUIERDO FORD SABLE, TAURUS	DAI-K-8953 TORNILLO ESTABILIZADOR FRONTAL FORD, LINCOLN, MERCURY	DAI-K-9210 BUJES PARA HORQUILLA SUP. TOYOTA HILUX, PICK UP
DAI-K-9468 BUJE SUPERIOR CHEVROLET LUV HONDA PASSPORT ISUZU AMIGO 4X2, RODEO	DAI-K-90204-B BUJE P/BARRA TENSORA TRASERA, ACCORD ACURA	FP01 GOMA SUSPENSION VW SEDAN TODOS	FP02 GOMA SUSPENSION VW SEDAN TODOS	FP03 GOMA SUSPENSION VW SEDAN TODOS

<p>FP04</p>  <p>GOMA SUSPENSION VW SEDAN</p>	<p>FP05</p>  <p>GOMA SUSPENSION IZQ. Y DER., VW COMBI</p>	<p>FP06</p>  <p>GOMA ESCAPE NISSAN TSURU II</p>	<p>FP07</p>  <p>GOMA ESCAPE NISSAN TSURU II</p>	<p>FP08</p>  <p>GOMA ESCAPE NISSAN TSURU I</p>
<p>FP09</p>  <p>GOMA ESCAPE NISSAN TSURU I</p>	<p>31</p>  <p>GOMA PARA AMORTIGUADOR UNIVERSAL</p>	<p>32</p>  <p>GOMA PARA AMORTIGUADOR INTERNATIONAL</p>	<p>34</p>  <p>GOMA PARA AMORTIGUADOR CHEVROLET, FORD CHRYSLER VARIOS</p>	<p>36</p>  <p>GOMA PARA AMORTIGUADOR DODGE, FORD, CHEVROLET CAMION</p>
<p>37</p>  <p>GOMA PARA AMORTIGUADOR CHRYSLER VARIOS</p>	<p>38</p>  <p>GOMA PARA AMORTIGUADOR CHRYSLER VARIOS</p>	<p>43</p>  <p>GOMA PARA AMORTIGUADOR FORD VARIOS</p>	<p>50</p>  <p>GOMA PARA AMORTIGUADOR VAM VARIOS</p>	<p>54</p>  <p>RONDANA METALICA UNIVERSAL</p>
<p>64</p>  <p>GOMA PARA AMORTIGUADOR UNIVERSAL</p>	<p>65</p>  <p>GOMA PARA AMORTIGUADOR VAM</p>	<p>67</p>  <p>GOMA PARA AMORTIGUADOR FORD VARIOS</p>	<p>68</p>  <p>GOMA ESCAPE FORD VARIOS</p>	<p>69</p>  <p>GOMA ESCAPE FORD VARIOS</p>
<p>70</p>  <p>GOMA SUJETADORA DE ESCAPE FORD, MUSTANG</p>	<p>71</p>  <p>GOMA AMORTIGUADOR UNIVERSAL</p>	<p>72</p>  <p>GOMA SUJETADORA DE ESCAPE FORD, THUNDERBIRD</p>	<p>73</p>  <p>AUMENTO PARA RESORTE FORD TOPAZ</p>	<p>74</p>  <p>GOMA PARA BARRA ESTABILIZADORA NISSAN PICK TODOS</p>
<p>75</p>  <p>REP. BASE P/AMORTIGUADOR VW GOLF A2, JETTA A3 POINTER</p>	<p>76</p>  <p>REP. BASE P/AMORTIGUADOR VW GOLF A2, JETTA A3 POINTER</p>	<p>77</p>  <p>GOMA PARA AMORTIGUADOR VW COMBI</p>	<p>78</p>  <p>GOMA PARA AMORTIGUADOR VW GOLF, JETTA</p>	<p>81</p>  <p>CAPUCHON DE CABLE PARA BUJIA LADO DISTRIBUIDOR UNIVERSAL</p>

































<p>83</p>  <p>CAPUCHON PARA CABLE DE BUJIAS LADO BUJIA UNIVERSAL</p>	<p>84</p>  <p>CAPUCHON DE CABLE PARA BUJIA LADO BOBINA UNIVERSAL</p>	<p>92</p>  <p>TOPE REBOTE P/CAJUELA CHEVROLET CHEVY, MONZA</p>	<p>93</p>  <p>GOMA P/ BARRA ESTABILIZADORA FORD PICK UP, F-100, F-150</p>	<p>100</p>  <p>CONJUNTO DE GOMAS DEL PARA CASETA CHEVROLET AUTOS</p>
<p>101</p>  <p>CONJUNTO DE GOMAS TRASERAS PARA CASETA CHEVROLET AUTOS</p>	<p>102</p>  <p>JGO. CASETA CHASIS TRAS. CHEVROLET CAMIONETAS</p>	<p>103</p>  <p>JGO. CASETA CHASIS FRONTAL, FORD CAMIONETAS</p>	<p>104</p>  <p>JGO. CASETA CHASIS TRAS. FORD CAMIONETAS</p>	<p>105</p>  <p>JGO. CASETA CHASIS DEL. NISSAN CAMIONETAS</p>
<p>106</p>  <p>JGO. CASETA CHASIS TRAS. NISSAN CAMIONETAS</p>	<p>107</p>  <p>JGO. CASETA CHASIS TRAS. CHEVROLET AUTOS Y CAM.</p>	<p>108</p>  <p>JGO. CASETA CHASIS TRAS. CHEV. AUTOS Y CAM.</p>	<p>109</p>  <p>JGO. CASETA CHASIS VW SEDAN</p>	<p>207</p>  <p>GOMA PARA SOPORTE FLECHA CARDAN 224 CHEVROLET BLAZER</p>
<p>209</p>  <p>GOMA PARA SOPORTE FLECHA CARDAN DAI-219 BALERO 88508, CHEVROLET</p>	<p>219</p>  <p>SOPORTE P/FLECHA CARDAN GOMA 209 CON BALERO 88508 CHEVROLET</p>	<p>224</p>  <p>SOPORTE P/FLECHA CARDAN GOMAS 207, 230 CON BALERO 88107 CHEVROLET</p>	<p>225</p>  <p>GOMA PARA SOPORTE FLECHA CARDAN NISSAN D-21</p>	<p>226</p>  <p>GOMA PARA SOPORTE FLECHA CARDAN 411 CON BALERO 88509 CHEVROLET</p>
<p>230</p>  <p>GOMA PARA SOPORTE FLECHA CARDAN DAI-418 CHEVROLET</p>	<p>300</p>  <p>BUJE P/HORQUILLA FRONTAL CHICO VW CARIBE, ATLANTIC</p>	<p>301</p>  <p>BUJE PARA HORQUILLA GRANDE (PUNTA) VW CARIBE, ATLANTIC</p>	<p>302</p>  <p>TOPE PARA SUSPENSION CHEVROLET VARIOS</p>	<p>304</p>  <p>TOPE PARA SUSPENSION FRONTAL FORD VARIOS</p>
<p>306</p>  <p>TOPE PARA SUSPENSION FRONTAL FORD VARIOS</p>	<p>312</p>  <p>TOPE PARA SUSPENSION TRASERA FORD VARIOS</p>	<p>315</p>  <p>TOPE PARA SUSPENSION FRONTAL FORD VARIOS</p>	<p>318</p>  <p>TOPE PARA SUSPENSION TRASERA, FORD VARIOS</p>	<p>331</p>  <p>TOPE PARA SUSPENSION FRONTAL VW GOLF, JETTA</p>

<p>332</p>  <p>TOPE PARA AMORTIGUADOR TRASERO, VW COMBI</p>	<p>347</p>  <p>TOPE PARA SUSPENSIÓN CHRYSLER VARIOS</p>	<p>351</p>  <p>TOPE PARA SUSPENSIÓN FRONTAL, CHRYSLER VAM</p>	<p>354</p>  <p>TOPE PARA SUSPENSIÓN TRASERA (DIFERENCIAL) FORD CAMIONETAS</p>	<p>356</p>  <p>TOPE PARA SUSPENSIÓN TRASERA, NISSAN VARIOS</p>
<p>357</p>  <p>TOPE DE SUSPENSIÓN FRONTAL, FORD F-350</p>	<p>358</p>  <p>TOPE DE SUSPENSIÓN VARIOS</p>	<p>370</p>  <p>GOMA PARA PEDAL ACELERADOR VW COMBI</p>	<p>379</p>  <p>TOPE PARA SUSPENSIÓN FRONTAL NISSAN ICHIVAN</p>	<p>382</p>  <p>TOPE PARA SUSPENSIÓN TRASERA NISSAN DATSUN</p>
<p>388</p>  <p>TOPE PARA HORQUILLA CHRYSLER AUTOS Y CAM.</p>	<p>390</p>  <p>TOPE PARA SUSPENSIÓN NISSAN DATSUN</p>	<p>392</p>  <p>TOPE PARA SUSPENSIÓN NISSAN VARIOS</p>	<p>395</p>  <p>TOPE PARA SUSPENSIÓN FORD VARIOS</p>	<p>400</p>  <p>CALZA PARA RESORTE UNIVERSAL</p>
<p>401</p>  <p>CALZA PARA RESORTE UNIVERSAL</p>	<p>402</p>  <p>CALZA PARA RESORTE UNIVERSAL</p>	<p>403</p>  <p>CALZA PARA RESORTE UNIVERSAL</p>	<p>404</p>  <p>SEPARADOR RESORTE SUSP. TIPO NUEVO</p>	<p>407</p>  <p>AUMENTO PARA RESORTE CHEVROLET AUTOS</p>
<p>408</p>  <p>AUMENTO PARA RESORTE UNIVERSAL</p>	<p>409</p>  <p>AUMENTO PARA RESORTE VW GOLF, JETTA</p>	<p>410</p>  <p>SOPORTE P/ FLECHA CARDAN SIN BALERO, NISSAN D-21</p>	<p>411</p>  <p>SOPORTE P/FLECHA CARDAN CON BALERO 88509 CHEVROLET C-15, C-1500</p>	<p>414</p>  <p>SOPORTE P/FLECHA CARDAN GOMAS 207, 230 CON BALERO 88107 CHEVROLET BLAZER</p>
<p>438</p>  <p>SOP. PARA FLECHA CARDAN CHEVROLET SUBURBAN SILVERADO</p>	<p>440</p>  <p>SOPORTE PARA FLECHA CARDAN MERCEDES BENZ, SPRINTER</p>	<p>441</p>  <p>SOPORTE PARA FLECHA CARDAN BMW 318i, 318is 323is, 325i, 328i, 525i, 530i, z3</p>	<p>500</p>  <p>GOMA SUPERIOR PARA RADIADOR CHEVROLET VARIOS</p>	<p>501</p>  <p>GOMA INFERIOR PARA RADIADOR CHEVROLET VARIOS</p>



502 GOMA PARA RADIADOR FORD VARIOS	504 GOMA INFERIOR PARA RADIADOR FORD TOPAZ	505 GOMA PARA AMORTIGUADOR UNIVERSAL	506 GOMA PARA EL ALTERNADOR CHRYSLER AUTOS	507 GOMA PARA RADIADOR NISSAN TSURU II
512 GOMA PARA BARRA ESTAB. CHRYSLER VARIOS	601 COPE PARA DIRECCIÓN STD. FORD VARIOS	602 COPE PARA DIRECCIÓN STD., FORD VARIOS	603 COPE PARA DIRECCIÓN STD., FORD VARIOS	604 COPE PARA DIRECCIÓN FORD F-150, F-350
605 COPE PARA DIRECCIÓN HID. CHEVROLET, CHRYSLER VARIOS	606 COPE PARA DIRECCIÓN HID. CHEVROLET, CHRYLSER VARIOS	607 COPE PARA DIRECCIÓN FORD CAMIONETAS	608 COPE PARA DIRECCION NISSAN DATSUN, SAKURA	609 COPE PARA DIRECCION VW SEDAN, SAFARI
610 COPE PARA DIRECCIÓN COPE DOBLE, NISSAN	611 COPE PARA DIRECCIÓN FORD FAIRMONT	612 COPE PARA DIRECCIÓN VW COMBI PANEL	613 COPE PARA DIRECCIÓN VW CORSAR, ATLANTIC	614 COPE PARA DIRECCIÓN NISSAN PICK UP
615 COPE PARA DIRECCIÓN FORD VARIOS	616 COPE PARA DIRECCIÓN CHEVROLET S-10, S-15 FORD RANGER	617 COPE PARA DIRECCIÓN CHEVROLET, LUV, IZUSU	618 COPE PARA DIRECCIÓN TOYOTA AUTOS, PICK UP	619 COPE PARA DIRECCIÓN MAZDA, MITSUBISHI PICK UP
620 COPE PARA DIRECCIÓN FORD TODOS LOS MODELOS	621 COPE PARA DIRECCIÓN FORD TODOS LOS MODELOS	622 COPE PARA DIRECCIÓN CHEVROLET, CHRYSLER VARIOS	623 COPE PARA DIRECCIÓN VW SEDAN, BRASILIA	624 COPE PARA DIRECCIÓN VW COMBI, PANEL

<p>625</p>  <p>COPE PARA DIRECCIÓN FORD AUTOS Y CAMIONES</p>	<p>626</p>  <p>REP. COPE PARA DIRECCIÓN FORD FAIRMOUNT</p>	<p>627</p>  <p>REP. COPE PARA DIRECCIÓN AUDI VARIOS VW CORSAR ATLANTIC</p>	<p>628</p>  <p>REP. COPE PARA DIRECCIÓN NISSAN TSURU II VARIOS</p>	<p>629</p>  <p>REP. COPE PARA DIRECCIÓN CHEVROLET LUV</p>
<p>630</p>  <p>REP. COPE PARA DIRECCIÓN TOYOTA AUTOS, PICK UP</p>	<p>631</p>  <p>COPE MODELO ESPECIAL NISSAN SAKURA</p>	<p>640</p>  <p>GALLETAS DE DIRECCIÓN MAZDA MITSUBISHI P-GRUES</p>	<p>641</p>  <p>REPUESTO PARA COPE TOYOTA, MAZDA</p>	<p>642</p>  <p>GALLETAS ESPECIALES NISSAN D-21</p>
<p>648</p>  <p>GOMA SUJETADORA DE ESCAPE, FORD FIESTA</p>	<p>649</p>  <p>GOMA SUJETADORA DE ESCAPE, FORD FIESTA, IKON</p>	<p>650</p>  <p>GOMA SUJETADORA DE ESCAPE, CHEVROLET ASTRA</p>	<p>700</p>  <p>GOMA CREMALLERA DIR. STD. FORD TOPAZ</p>	<p>701</p>  <p>GOMA CREMALLERA DIR. DER., CHEVROLET CUTLASS</p>
<p>702</p>  <p>GOMA CREMALLERA DIR. IZQ. NISSAN TSURU II</p>	<p>703</p>  <p>GOMA CREMALLERA DIR. DER. NISSAN TSURU II</p>	<p>704</p>  <p>GOMA CREMALLERA DIR. DER. NISSAN TSURU II</p>	<p>705</p>  <p>GOMA CREMALLERA DIR. DER. NISSAN TSURU I</p>	<p>706</p>  <p>GOMA CREMALLERA DIR. DER. NISSAN TSURU III</p>
<p>707</p>  <p>GOMA CREMALLERA DIR. DER. NISSAN TSURU III</p>	<p>708</p>  <p>GOMA CREMALLERA DIR. IZQ., VW CARIBE, ATLANTIC</p>	<p>709</p>  <p>GOMA CREMALLERA DIR. DER., VW CARIBE ATLANTIC</p>	<p>710</p>  <p>GOMA CREMALLERA DIR. HIDR., FORD TOPAZ</p>	<p>711</p>  <p>GOMA CREMALLERA DIR. CHRYSLER SERIE K</p>
<p>712</p>  <p>GOMA CREMALLERA DIR. DER. CHRYSLER STRATUS, CIRRUS</p>	<p>713</p>  <p>GOMA CREMALLERA DIR. IZQ. CHRYSLER STRATUS CIRRUS</p>	<p>714</p>  <p>GOMA CREMALLERA DIR. STD. FORD TOPAZ</p>	<p>715</p>  <p>GOMA CREMALLERA DIR. HIDR. FORD TOPAZ</p>	<p>716</p>  <p>GOMA CREMALLERA DIR. STD. FORD TOPAZ</p>



717  GOMA CREMALLERA DIR. IZQ., CHEVROLET CUTLASS	718  GOMA CREMALLERA DIR. IZQ., NISSAN TSURU III	719  GOMA CREMALLERA DIR. DER., FORD MISTIQUE	720  GOMA CREMALLERA DIR. IZQ. FORD MISTIQUE	722  GOMA PARA CAJA DE DIR. RENAULT CLIO, MEGANE I y II
800  TAPON MEDIANO PARA GATO HIDR. UNIVERSAL	801  TAPON GRANDE PARA GATO HIDR. UNIVERSAL	802  SELLO PARA PISTON UNIVERSAL	803  SELLO PARA PISTON UNIVERSAL	804  SELLO PARA PISTON VARIOS
805  SELLO PARA PISTON VARIOS	806  SELLO PARA PISTON VARIOS	807  SELLO PARA GATO HID. VARIOS	808  SELLO PARA PISTON DE GATO HID. VARIOS	809  SELLO PARA PISTON DE GATO HID. VARIOS
810  SELLO PARA GATO HID. VARIOS	811  TAPON CHICO PARA GATO HIDR., VARIOS	850  CUBRE POLVO PARA ROTULA UNIVERSAL	851  CUBRE POLVO PARA ROTULA UNIVERSAL	852  CUBRE POLVO PARA ROTULA UNIVERSAL
853  CUBRE POLVO PARA ROTULA UNIVERSAL	854  CUBRE POLVO PARA ROTULA UNIVERSAL	855  CUBRE POLVO PARA ROTULA UNIVERSAL	856  CUBRE POLVO PARA ROTULA UNIVERSAL	857  CUBRE POLVO PARA ROTULA UNIVERSAL
858  CUBRE POLVO PARA ROTULA UNIVERSAL	859  CUBRE POLVO PARA ROTULA UNIVERSAL	860  CUBRE POLVO PARA ROTULA UNIVERSAL	1100  SOP. MOTOR FORD CAMIONETAS	1127  SOP. TRANS. INFERIOR CHRYSLER SERIES 100-900

<p>1149</p>  <p>SOP. MOTOR IZQ. Y DER. JEEP CJ3</p>	<p>1150</p>  <p>SOP. PARA MOTOR CENTRAL CHEVROLET C-80, C-85</p>	<p>1164</p>  <p>SOP. MOTOR IZQ. Y DER. FORD AUTOS</p>	<p>1166</p>  <p>SOP. LATERAL CHEVROLET AUTOS</p>	<p>1417</p>  <p>SOP. MOTOR SUPERIOR CHEVROLET CAMIONETAS</p>
<p>1418</p>  <p>SOP. MOTOR INFERIOR CHEVROLET CAMIONETAS</p>	<p>1431</p>  <p>SOP. MOTOR SUP. IZQ Y DER FORD AUTOS Y CAM.</p>	<p>1432</p>  <p>SOP. TRANSMISIÓN FORD F-350, F-450</p>	<p>1467</p>  <p>SOP. MOTOR DELANTERO CHEVROLET AUTOS Y CAM.</p>	<p>1576</p>  <p>SOP. MOTOR IZQ. Y DER. CHEVROLET CAM. C10, 20</p>
<p>1577</p>  <p>SOP. TRANSMISION CHEVROLET SERIES C 10-20</p>	<p>1630</p>  <p>SOP. MOTOR SUPERIOR CHEVROLET 2-3 1/2 TONS.</p>	<p>1631</p>  <p>SOP. MOTOR INFERIOR CHEVROLET 2-3 1/2 TONS.</p>	<p>1640</p>  <p>SOP. MOTOR SUPERIOR FORD SERIES F350-700</p>	<p>1643</p>  <p>SOP. TRANS. IZQ. Y DER. CHRYSLER CT800-900</p>
<p>1646</p>  <p>SOP. MOTOR IZQ. CHRYSLER DART</p>	<p>1648</p>  <p>SOP. TRANSMISIÓN CHRYSLER DART, VALIANT</p>	<p>1649</p>  <p>SOP. MOTOR IZQUIERDO CHRYSLER AUTOS Y CAM.</p>	<p>1652</p>  <p>SOP. TRASERO SUPERIOR FORD SERIE F600</p>	<p>1653</p>  <p>SOP. TRANSMISION STD. Y AUT., FORD GALAXIE</p>
<p>1654</p>  <p>SOP. MOTOR IZQ. Y DER. FORD GALAXIE</p>	<p>1656</p>  <p>SOP. MOTOR IZQUIERDO CHRYSLER PLYMOUTH CORONET</p>	<p>1657</p>  <p>SOP. MOTOR DERECHO CHRYSLER DART, VALIANT</p>	<p>1658</p>  <p>SOP. MOTOR DERECHO CHRYSLER PLYMOUTH</p>	<p>1659</p>  <p>SOP. MOTOR DERECHO CHRYSLER PLYMOUTH CORONET</p>
<p>1660</p>  <p>SOP. TRANSMISIÓN IZQ. Y DER. CHRYSLER D-600, D-900</p>	<p>1663</p>  <p>SOP. TRANSMISIÓN STD. JEEP WILLYS</p>	<p>1664</p>  <p>SOP. MOTOR IZQUIERDO CHRYSLER VALIANT BARRACUDA</p>	<p>1672</p>  <p>SOP. MOTOR DERECHO CHRYSLER PLYMOUTH, BARRACUDA</p>	<p>1675</p>  <p>SOP. MOTOR IZQ. Y DER. CHEVROLET C-10, C-30, CAPRICE</p>



<p>1678</p>  <p>SOP. MOTOR IZQ. Y DER. CHRYSLER MOTOR PERKINS</p>	<p>1680</p>  <p>SOP. MOTOR CENTRAL CHRYSLER MOTOR PERKINS</p>	<p>1685</p>  <p>SOP. TRANSMISIÓN IZQ. Y DER. FORD SERIES F600</p>	<p>1700</p>  <p>SOP. TRANSMISIÓN TRAS. INFERIOR FORD SERIES F700-800</p>	<p>1701</p>  <p>SOPORTE MOTOR FRONTAL OPEL RECKORD OLIMPIA</p>
<p>1704</p>  <p>SOP. TRANSMISIÓN STD. Y AUT. CHEVROLET C-10, CHEVY</p>	<p>1706</p>  <p>SOP. TRANSMISIÓN IZQ. Y DER. CHRYSLER CT 800, CT 900</p>	<p>1707</p>  <p>SOP. TRANSMISIÓN AUT. FORD GALAXIE</p>	<p>1708</p>  <p>SOP. TRANSMISIÓN STD. FORD GALAXIE</p>	<p>1709</p>  <p>SOP. MOTOR IZQ. Y DER. CHEVROLET C-30, C-35</p>
<p>1711</p>  <p>SOP. MOTOR IZQ. JEEP JAVELIN, AMERICAN</p>	<p>1713</p>  <p>SOP. MOTOR IZQ. Y DER. FORD SERIES F-350</p>	<p>1714</p>  <p>SOP. MOTOR IZQ. Y DER. FORD F-100, F-150</p>	<p>1715</p>  <p>SOP. MOTOR IZQ. Y DER. VW SEDAN, BRASILIA</p>	<p>1717</p>  <p>SOP. MOTOR DERECHO NISSAN DATSUN, SEDAN, VAGONETA</p>
<p>1719</p>  <p>SOP. TRANS. AUT. Y STD. FORD F-100, F-350</p>	<p>1723</p>  <p>SOP. MOTOR SUPERIOR IZQ. Y DER. CHEVROLET CAMIONETAS</p>	<p>1725</p>  <p>SOP. TRANSMISIÓN AUT. Y STD. FORD MAVERICK</p>	<p>1727</p>  <p>SOP. MOTOR IZQ. Y DER. FORD MUSTANG</p>	<p>1732</p>  <p>SOP. MOTOR IZQ. Y DER. RENAULT R-8, R-10</p>
<p>1734</p>  <p>SOP. TRANSMISIÓN CHEVROLET C-10, C-30</p>	<p>1736</p>  <p>SOP. MOTOR IZQ. Y DER. CHEVROLET C-10, C-30</p>	<p>1743</p>  <p>SOP. MOTOR IZQ. Y DER. CHRYSLER DART, VALIANT</p>	<p>1748</p>  <p>SOP. MOTOR IZQUIERDO FORD GALAXIE</p>	<p>1749</p>  <p>SOP. MOTOR DERECHO FORD GALAXIE</p>
<p>1751</p>  <p>SOP. MOTOR IZQUIERDO FORD FALCON</p>	<p>1752</p>  <p>SOP. MOTOR DERECHO FORD FALCON</p>	<p>1757</p>  <p>SOP. TRANSMISIÓN STD. Y AUT. CHEVROLET IMPALA, CAPRICE</p>	<p>1758</p>  <p>SOP. TRANSMISIÓN AUT. Y STD. FORD FALCON, MUSTANG</p>	<p>1760</p>  <p>SOP. TRANSMISIÓN STD. FORD GALAXIE</p>

<p>1761</p>  <p>SOP. MOTOR IZQUIERDO CHRYSLER BARRACUDA</p>	<p>1763</p>  <p>SOP. MOTOR DERECHO CHRYSLER DART, VALIANT</p>	<p>1764</p>  <p>SOP. MOTOR IZQUIERDO CHRYSLER DART, VALIANT</p>	<p>1765</p>  <p>SOP. MOTOR DERECHO CHRYSLER MAGNUM</p>	<p>1767</p>  <p>SOP. MOTOR IZQ. Y DER. RENAULT R12, TL, TS</p>
<p>1768</p>  <p>SOP. TRANS. STD. Y AUT. RENAULT R12, TL, TS</p>	<p>1769</p>  <p>SOP. MOTOR IZQ. Y DER. CHEVROLET C-10, CHEVELLE</p>	<p>1770</p>  <p>SOP. MOTOR IZQ. Y DER. VAM RAMBLER</p>	<p>1771</p>  <p>SOP. MOTOR IZQ. Y DER. CHEVROLET CHEVY NOVA</p>	<p>1772</p>  <p>SOP. MOTOR IZQ. Y DER. FORD MUSTANG</p>
<p>1773</p>  <p>SOP. TRANS. AUT. Y STD. FORD MAVERICK</p>	<p>1775</p>  <p>SOP. TRANS. AUT. Y STD. CHRYSLER DART, VALIANT</p>	<p>1776</p>  <p>SOP. TRANSMISIÓN STD. CHRYSLER D-100, D-300</p>	<p>1777</p>  <p>SOP. MOTOR DERECHO JEEP C-J, WILLYS</p>	<p>1778</p>  <p>SOP. TRANSMISIÓN AUT. VAM RAMBLER, JAVELIN</p>
<p>1779</p>  <p>SOP. TRANS. AUT. Y STD. CHEVROLET CHEVY, IMPALA, CHEVELLE</p>	<p>1781</p>  <p>SOP. MOTOR IZQ. Y DER. CHEVROLET C-30, C-35</p>	<p>1782</p>  <p>SOP. MOTOR IZQ. Y DER. CHEVROLET C-10, C-15</p>	<p>1783</p>  <p>SOP. TRANSMISIÓN STD. VAM RAMBLER, JAVELIN</p>	<p>1784</p>  <p>SOPORTE TRANSMISIÓN VAM RAMBLER</p>
<p>1785</p>  <p>SOP. MOTOR IZQ. Y DER. NISSAN DATSUN SEDAN, VAGONETA</p>	<p>1786</p>  <p>SOP. TRANSMISIÓN STD. NISSAN DATSUN</p>	<p>1790</p>  <p>SOP. TRANSMISIÓN STD. RENAULT R5</p>	<p>1794</p>  <p>SOP. MOTOR DERECHO NISSAN DATSUN</p>	<p>1796</p>  <p>SOP. MOTOR IZQ. Y DER. CHRYSLER D-150, D-350</p>
<p>1797</p>  <p>SOP. MOTOR IZQ. Y DER. FORD BRONCO F-100, F-350</p>	<p>1798</p>  <p>SOP. TRANSMISIÓN FORD BRONCO, F-100, F-350</p>	<p>1799</p>  <p>SOP. MOTOR IZQ. Y DER. CHRYSLER D-150, D-350</p>	<p>1800</p>  <p>SOP. TRANSMISIÓN NISSAN D-21</p>	<p>1802</p>  <p>SOP. TRANSMISIÓN STD. NISSAN DATSUN, VAGONETA</p>



1803 SOP. MOTOR IZQUIERDO NISSAN DATSUN	1804 SOP. MOTOR IZQ. Y DER. CHRYSLER PERKINS	1805 SOP. TRANSMISIÓN VW SEDAN, BRASILIA	1808,1808-KIT BASE DELANTERA CHRYSLER DART K, VOLARE K	1809 SOP. TORSION TRASERO CHRYSLER DART K, VOLARE K
1810 SOP. MOTOR DERECHO CHRYSLER DART K, VOLARE K	1812 SOP. TRANSMISIÓN CHEVROLET SERIES C-10-35	1813 SOP. TRANSMISIÓN CHEVROLET C-10, C-35	1814 SOP. MOTOR DERECHO CHEVROLET CELEBRITY, CITATION	1815, 1815-KIT BASE DELANTERA VW GOLF, JETTA A-4, BEETLE
1816 BASE FRONTAL IZQ. Y DER. SEAT ALHAMBRA, JETTA A4	1817 SOP. TRANSMISIÓN STD. NISSAN TSURU I	1818 SOP. TRANSMISIÓN AUT. NISSAN TSURU I	1820, 1820-KIT BASE DELANTERA CHRYSLER DART K, VOLARE K	1821, 1821-KIT BASE TRASERA, IZQ. Y DER. BUICK LE SABRE, CADILLAC
1822 BASE TRASERA IZQ. Y DER. FORD FIESTA, IKON	1823 SOP. MOTOR DERECHO FORD GHIA TOPAZ	1824 SOP. MOTOR IZQ. Y DER. NISSAN D-21	1826 COMPLEMENTO PARA HORQUILLA LIMITADORA FORD TOPAZ	1829-KIT BASE FRONTAL IZQ. Y DER. FORD IKON, COURIER, KA
1830 SOPORTE MOTOR FRONTAL NISSAN TSURU I	1831 SOPORTE MOTOR TRASERO NISSAN TSURU I	1832 SOP. TRANSMISIÓN VW CARIBE, ATLANTIC	1833 REP. SOP. MOTOR VW CARIBE, ATLANTIC	1834 SOP. MOTOR IZQ. Y DER. NISSAN SEDAN, VAGONETA
1835 SOP. MOTOR IZQ. Y DER. VW COMBI, PANEL	1837 SOP. TRANSMISIÓN TRAS. IZQ. CHEVROLET CITATION, CELEBRITY	1838 SOP. TRANSMISIÓN TRAS. IZQ. CHEVROLET CITATION, CELEBRITY	1839 SOPORTE TRANSMISIÓN FRONTAL IZQ. CHEVROLET CITATION	1840 SOPORTE O BASE PARA CARBURADOR VW ATLANTIC, CARIBE



<p>1841</p>  <p>SOP. MOTOR IZQ. Y DER. NISSAN ICHI VAN</p>	<p>1842</p>  <p>SOP. TRANSMISIÓN NISSAN ICHI VAN</p>	<p>1843</p>  <p>SOP. MOTOR FRONTAL DER. NISSAN ICHI VAN</p>	<p>1844</p>  <p>SOP. MOTOR FRONTAL IZQ. NISSAN ICHI VAN</p>	<p>1845</p>  <p>SOP. TRANSMISIÓN AUT. FORD FAIRMONT, MUSTANG</p>
<p>1846</p>  <p>SOP. TRANSMISIÓN STD. FORD FAIRMONT, MUSTANG</p>	<p>1847</p>  <p>REP. SOP. MOTOR IZQ. (1862) FORD FAIRMONT, MUSTANG</p>	<p>1848</p>  <p>REP. SOP. MOTOR DER. (1863) FORD FAIRMONT, MUSTANG</p>	<p>1849</p>  <p>REP. SOP. MOTOR DER. (1865) FORD SERIES F150-200</p>	<p>1850</p>  <p>REP. SOP. MOTOR IZQ. (1866) FORD SERIES F150-200</p>
<p>1852-KIT</p>  <p>BASE FRONTAL IZQ. Y DER. VW, GOLF, JETTA</p>	<p>1855</p>  <p>BASE FRONTAL IZQ. Y DER. FORD TOPAZ, GHIA</p>	<p>1856</p>  <p>SOP. TRANSMISIÓN JEEP WAGONNER</p>	<p>1860</p>  <p>BASE FRONTAL IZQ. Y DER. VW JETTA A2, GOLF A2</p>	<p>1861</p>  <p>BASE PARA CARBURADOR VW GOLF A2, JETTA A2</p>
<p>1862</p>  <p>SOP. MOTOR IZQUIERDO FORD FAIRMONT, MUSTANG</p>	<p>1863</p>  <p>SOP. MOTOR DERECHO FORD FAIRMONT, MUSTANG</p>	<p>1864</p>  <p>SOP. TORSIÓN FRONT. SUP. CHEVROLET CITATION, CELEBRITY</p>	<p>1865</p>  <p>SOP. MOTOR DERECHO FORD F-150, F-200</p>	<p>1866</p>  <p>SOP. MOTOR IZQUIERDO FORD F-150, F-200</p>
<p>1867</p>  <p>REPUESTO SOP. MOTOR VW CARIBE, ATLANTIC</p>	<p>1868</p>  <p>REP. SOP. MOTOR (1910) CHRYSLER DART K, LE BARON K</p>	<p>1870</p>  <p>SOP. TRANSMISIÓN IZQ. FORD GUIA, TOPAZ, TEMPO</p>	<p>1870-9</p>  <p>REP. SOP. TRANS. IZQ. (1870) FORD GHIA, TOPAZ, TEMPO</p>	<p>1871</p>  <p>SOP. MOTOR FRONTAL FORD GHIA, TOPAZ, TEMPO</p>
<p>1872</p>  <p>SOP. MOTOR FRONTAL FORD GUIA, TOPAZ, TEMPO</p>	<p>1873</p>  <p>SOP. MOTOR TRASERO FORD GUIA, TOPAZ, TEMPO</p>	<p>1873-9</p>  <p>REP. SOP. MOT. TRAS. (1873) FORD GUIA, TOPAZ, TEMPO</p>	<p>1874</p>  <p>REP. SOP. MOTOR DER. (1823) FORD GUIA, TOPAZ, TEMPO</p>	<p>1879</p>  <p>SOP. MOTOR IZQUIERDO FORD F250, F-350</p>





1880  SOP. MOTOR DERECHO FORD F250, F-350	1881-H  SOP. MOTOR IZQ. Y DER. FORD COUGAR, THUNDERBIRD	1882  SOP. PARA CONVERTIDOR CATALITICO, VW COMBI	1884  SOP. TRANSMISION AUT. FORD GHIA, TOPAZ, TEMPO	1884-H  SOP. TRANSMISION AUT. FORD GHIA, TOPAZ, TEMPO
1886, 1886-KIT  BASE FRONTAL IZQ. Y DER. VW GOLF, JETTA A-2	1887  GOMA PARA BARRA ESTABILIZADORA CHEVROLET CAMIONETAS	1887-9  GOMA PARA BARRA ESTABILIZADORA CHEVROLET CAMIONETAS	1890, 1890-KIT  BASE FRONTAL IZQ. Y DER. VW CARIBE, ATLANTIC	1891  SOP. MOTOR IZQ. Y DER. CHRYSLER RAM CHARGER, PICK UP
1892  SOP. MOTOR IZQ. Y DER. CHRYSLER RAM CHARGER, PICK UP	1894  SOP. TRANSMISION CHRYSLER CHARGER, PICK UP	1895  SOP. TRANSMISION AUT. CHRYSLER CHARGER, PICK UP	1896  SOP. TRANSMISION FORD SERIES F250, F-350	1897  SOP. MOTOR IZQ. Y DER. FORD SERIES F-250, F-350
1898  SOP. MOTOR IZQ. Y DER. CHRYSLER D-350	1899  SOP. MOTOR IZQ. Y DER. CHRYSLER D-350	1900  SOP. MOTOR IZQ. Y DER. VW PANEL, CORSA, POINTER	1901  SOP. MOTOR TRASERO NISSAN TSURU II	1902  SOP. MOTOR FRONTAL NISSAN TSURU II
1903  SOP. MOTOR IZQUIERDO VW SEDAN	1904  SOP. MOTOR DERECHO VW SEDAN	1905  SOP. MOTOR FRONTAL DER. CHEVROLET CHEVY JOY, SWING	1906  SOP. MOTOR TRASERO CHEVROLET CHEVY JOY, SWING	1908  REP. SOP. MOTOR DER. NISSAN TSURU II
1909  SOP. MOTOR TRASERO CHEVROLET CAVALIER, Z-24	1910  SOP. MOTOR FRONTAL CHRYSLER DART, K, LE BARON K	1911  SOP. TRANSMISION CHEVROLET CHEYNE, SILVERADO	1912  SOP. MOTOR DERECHO CHRYSLER RAM 4X2, 4X4	1912-9  REP. SOP. MOTOR DER (1912) CHRYSLER RAM 1500 RAM 2500, RAM 3500

<p>1913</p>  <p>SOP. MOTOR IZQUIERDO CHRYSLER RAM 1500 RAM 2500, RAM 3500</p>	<p>1913-9</p>  <p>REP. SOP. MOTOR IZQ. (1913) CHRYSLER RAM 1500 RAM 2500, RAM 3500</p>	<p>1914-9</p>  <p>REP. SOP. MOTOR DER. CHRYSLER RAM 1500 RAM 2500, RAM 3500</p>	<p>1915-9</p>  <p>REP. SOP. MOTOR IZQ. CHRYSLER RAM 1500 RAM 2500, RAM 3500</p>	<p>1917</p>  <p>SOP. TRANSMISIÓN CHRYSLER RAM 1500 RAM 2500, RAM 3500</p>
<p>1918</p>  <p>SOP. TRANSMISIÓN CHRYSLER RAM 1500 RAM 2500, RAM 3500</p>	<p>1919</p>  <p>SOP. TRANSMISIÓN CHRYSLER RAM 1500 RAM 2500, RAM 3500</p>	<p>1920</p>  <p>SOP. MOTOR IZQ. Y DER. CHEVROLET SUBURBAN, TAHOE, SAVANA</p>	<p>1924</p>  <p>SOP. TRANSMISIÓN VW BRASILIA, SAFARI</p>	<p>1926</p>  <p>SOP. MOTOR IZQUIERDO FORD FALCON, MUSTANG, GALAXIE</p>
<p>1927</p>  <p>REP. SOP. MOT. FRONT. (6651) CHRYSLER SHADOW, PANTHOM</p>	<p>1928</p>  <p>REP. SOP. TRANS. (6668) CHRYSLER SHADOW, SPIRIT</p>	<p>1929</p>  <p>SOP. MOTOR FRONTAL IZQ. CHEVROLET CHEVY, JOY, SWING</p>	<p>1932</p>  <p>SOP. TRANSMISIÓN CHEVROLET SUBURBAN ISUZU HOMBRE</p>	<p>1934</p>  <p>SOP. MOTOR IZQUIERDO CHEVROLET CHEVY JOY, SWING</p>
<p>1935</p>  <p>SOP. TRASERO C/AIRE CHEVROLET CHEVY JOY, SWING</p>	<p>1940</p>  <p>SOP. TRANSMISIÓN AUT. CHEVROLET SUBURBAN, SILVERADO</p>	<p>1941</p>  <p>REP. SOP. MOT. (6685 Y 6686) NISSAN TSURU III, TSUBAME</p>	<p>1942</p>  <p>SOP. TRANSMISIÓN VW PANEL, COMBI</p>	<p>1942-9</p>  <p>REP. SOP. TRANS. (1942) VW PANEL, COMBI</p>
<p>1943</p>  <p>REP. SOP. MOTOR DER. (6665) NISSAN TSURU I</p>	<p>1944</p>  <p>REP. SOP. MOT. TRAS. (7010) NISSAN ALMERA, SENTRA, SCALA</p>	<p>1949</p>  <p>SOP. TRANSMISIÓN FORD BRONCO</p>	<p>1970</p>  <p>SOP. MOTOR DERECHO CHEVROLET CENTURY, CUTLASS</p>	<p>1971</p>  <p>SOP. MOTOR FRONTAL DER. CHEVROLET BERETTA PONTIAC GRAND AM</p>
<p>1972</p>  <p>SOP. MOTOR FRONTAL DER. CHEVROLET CAVALIER Z-24, CORSICA</p>	<p>1973</p>  <p>REP. SOP. MOTOR DER. (6652) CHRYSLER VOYAGER, CARAVAN</p>	<p>1979</p>  <p>REP. TRANSMISIÓN IZQ. FORD GUÍA, TOPAZ, TEMPO</p>	<p>1980</p>  <p>SOP. MOTOR TRASERO DER. CHEVROLET CAVALIER PONTIAC GRAND AM</p>	<p>1982</p>  <p>REP. MOTOR FRONTAL VW GOLF A2, JETTA A-2</p>



1997 BASE FRONTAL IZQ. Y DER. CHEVROLET ASTRA, CORSA TORNADO, MERIVA, ZAFIRA	2000 TOPE P/AMORTIGUADOR FRONTAL IZQ. Y DER., NISSAN TSURU I, TSURU II, TSURU III	2001 TOPE P/AMORTIGUADOR FRONTAL IZQ. Y DER. NISSAN TSUBAME, TSURU III	2002 TOPE P/AMORTIGUADOR NISSAN LUCINO, SENTRA	2003 TOPE Y CUBRE POLVO TRASERO IZQ. Y DER. NISSAN TSURU III
2004 TOPE P/AMORTIGUADOR TRASERO IZQ. Y DER. NISSAN TSURU I, TSURU II	2005 TOPE P/AMORTIGUADOR TRASERO IZQ. Y DER. VW GOLF A2, GOLF A3 JETTA A3, POINTER	2006 TOPE P/AMORTIGUADOR TRASERO IZQ. Y DER. NISSAN TSUBAME	2007 TOPE P/AMORTIGUADOR FRONTAL IZQ. Y DER. HONDA CIVIC	2008 TOPE PARA AMORTIGUADOR FRONTAL IZQ. Y DER. FORD LOBO
2009 TOPE P/AMORT. Y CUBRE POLVO FRONT. IZQ. Y DER. FORD FIESTA, COURIER	2010 TOPE P/AMORTIGUADOR FRONTAL IZQ. Y DER., NISSAN PLATINA, RENAULT, CLIO	2011 TOPE P/AMORTIGUADOR FRONTAL IZQ. Y DER. HYUNDAI ATOS	2012 TOPE P/ AMORTIGUADOR TRASERO IZQ. Y DER. CHEVROLET EXPRESS VAM	2013 TOPE P/ AMORTIGUADOR TRASERO IZQ. Y DER. NISSAN PLATINA, RENAULT, CLIO
2015 GOMA PARA AMORTIGUADOR FORD LOBO	2018 TOPE PARA AMORTIGUADOR FRONTAL IZQ. Y DER. HONDA CITY, FIT	2348 BUJE PARA HORQUILLA DEL. INFERIOR, CHRYSLER AUTOS	2349 REP. SOP. TRANS. STD. Y AUT. (1762, 1775) CHRYSLER DART, VALIANT	2350 REP. SOP. MOT. DER. (1763) CHRYSLER DART, VALIANT
2352 REP. SOP. MOTOR IZQ. (1766) DER. (1765), CHRYSLER MONACO, MAGNUM	2353 REP. SOP. TRANS. (1776) CHRYSLER SERIES D-100 A D-300	2354 REP. SOP. TRANS. (1827) CHRYSLER DART, LE BARON K	2359 HORQUILLA INFERIOR NISSAN DATSUN SEDAN	2360 HORQUILLA INFERIOR NISSAN DATSUN SEDAN
6001 ASENTADOR PARA VÁLVULAS (AMERICANOS) UNIVERSAL VARIOS	6002 ASENTADOR PARA VÁLVULAS (EUROPEOS) UNIVERSAL VARIOS	6010 TAPON P/BOMBA DE AGUA CHRYSLER DART K, SHADOW	6011 TAPON BOMBA DE AGUA FORD, VAM	6012 TAPON BOMBA DE AGUA CHEVROLET VARIOS

<p>6030</p>  <p>AUMENTO PARA RESORTE UNIVERSAL VARIOS</p>	<p>6032</p>  <p>TOPE MUELLE FORD</p>	<p>6040</p>  <p>GOMA P/TIRANTE DE SUSPENSIÓN FORD F-350</p>	<p>6041</p>  <p>GOMA PARA BARRA ESTABILIZADORA VW SEDAN</p>	<p>6042</p>  <p>GOMA PARA BARRA ESTABILIZADORA VW COMBI</p>
<p>6046</p>  <p>GOMA PARA TIRANTE DE SUSPENSIÓN CHRYSLER VALIANT</p>	<p>6047</p>  <p>GOMA PARA TIRANTE DE SUSPENSIÓN FORD FALCON</p>	<p>6048</p>  <p>GOMA PARA TIRANTE DE SUSPENSIÓN FORD GALAXIE</p>	<p>6049</p>  <p>GOMA PARA TIRANTE DE SUSPENSIÓN FORD GALAXIE</p>	<p>6050</p>  <p>GOMA PARA TIRANTE DE SUSPENSIÓN FORD FALCON</p>
<p>6051</p>  <p>GOMA PARA TIRANTE DE SUSPENSIÓN FORD F-100 A F-250</p>	<p>6052</p>  <p>GOMA PARA TIRANTE DE SUSPENSIÓN NISSAN SEDAN</p>	<p>6053</p>  <p>BUJE PARA TIRANTE DE SUSPENSIÓN NISSAN D-21, CAMIONETAS</p>	<p>6054</p>  <p>GOMA PARA TIRANTE DE SUSPENSIÓN NISSAN SEDAN</p>	<p>6055</p>  <p>GOMA PARA TIRANTE DE SUSPENSIÓN CHRYSLER VALIANT</p>
<p>6056</p>  <p>GOMA PARA TIRANTE DE SUSPENSIÓN CHRYSLER, PICK UP</p>	<p>6057</p>  <p>GOMA P/BARRA DE TORSIÓN NISSAN CAMIONETAS</p>	<p>6058</p>  <p>GOMA PARA TIRANTE DE SUSPENSIÓN VAM RAMBLER</p>	<p>6059</p>  <p>BUJE P/BARRILLA DE DIR. VAM RAMBLER</p>	<p>6060</p>  <p>GOMA PARA BARRA ESTABILIZADORA NISSAN VARIOS</p>
<p>6061</p>  <p>GOMA P/BARRA ESTABILIZADORA NISSAN VARIOS</p>	<p>6062</p>  <p>GOMA P/BARRA ESTABILIZADORA NISSAN D-21</p>	<p>6063</p>  <p>GOMA P/BARRA ESTABILIZADORA FORD VARIOS</p>	<p>6064</p>  <p>GOMA P/BARRA ESTABILIZADORA FORD FAIRMONT</p>	<p>6065</p>  <p>GOMA P/BARRA ESTABILIZADORA CHEVROLET CHEVELLE</p>
<p>6066</p>  <p>GOMA P/BARRA ESTABILIZADORA RENAULT R12</p>	<p>6067</p>  <p>GOMA P/BARRA ESTABILIZADORA RENAULT R18</p>	<p>6068</p>  <p>BUJE BARRA TORSIÓN RENAULT R18</p>	<p>6069</p>  <p>BUJE PORTA MANGO NISSAN SEDAN</p>	<p>6070</p>  <p>GOMA PARA CREMALLERA DE DIR. VW GOLF A2</p>



<p>6071</p>  <p>GOMA TRAS. PARA CASETA UNIVERSAL VARIOS</p>	<p>6072</p>  <p>GOMA TRAS. PARA CASETA UNIVERSAL VARIOS</p>	<p>6073</p>  <p>GOMA TRAS. PARA CASETA UNIVERSAL VARIOS</p>	<p>6079</p>  <p>GOMA TRAS. PARA CASETA UNIVERSAL VARIOS</p>	<p>6080</p>  <p>CUBRE POLVO P/PALANCA DE VELOCIDADES NISSAN SEDAN</p>
<p>6081</p>  <p>CUBRE POLVO P/PALANCA DE VELOCIDADES NISSAN SEDAN</p>	<p>6082</p>  <p>CUBRE POLVO P/PALANCA DE VELOCIDADES NISSAN SEDAN</p>	<p>6083</p>  <p>CUBRE POLVO P/PALANCA DE VELOCIDADES NISSAN SEDAN</p>	<p>6084</p>  <p>CUBRE POLVO P/PALANCA DE VELOCIDADES FORD MUSTANG</p>	<p>6086</p>  <p>CUBRE POLVO P/PALANCA DE VELOCIDADES UNIVERSAL VARIOS</p>
<p>6097</p>  <p>TORNILLO ESTABILIZADOR FRONTAL IZQ. Y DER. GOLF A2, JETTA A2</p>	<p>6098</p>  <p>TORNILLO ESTABILIZADOR FRONTAL IZQ. Y DER. CORDOBA, MAGNUM</p>	<p>6099</p>  <p>TORNILLO ESTABILIZADOR CHRYSLER D-100 A D-350 RAM CHARGER</p>	<p>6100</p>  <p>TORNILLO ESTABILIZADOR CHEVROLET CHRYSLER FORD, NISSAN</p>	<p>6101</p>  <p>TORNILLO ESTABILIZADOR PONTIAC</p>
<p>6102</p>  <p>TORNILLO ESTABILIZADOR FORD, CHEVROLET</p>	<p>6103</p>  <p>TORNILLO ESTABILIZADOR FORD, FAIRMONT, MUSTANG LINCOLN, TOWN CAR</p>	<p>6104</p>  <p>TORNILLO ESTABILIZADOR CHEVROLET, CHRYSLER FORD, NISSAN</p>	<p>6105</p>  <p>TORNILLO ESTABILIZADOR CHEVROLET, CHRYSLER PONTIAC</p>	<p>6106</p>  <p>TORNILLO ESTABILIZADOR FORD, CHEVROLET OLDSMOBILE, PONTIAC</p>
<p>6107</p>  <p>TORNILLO ESTABILIZADOR CHEVROLET, FORD LINCOLN</p>	<p>6108</p>  <p>TORNILLO ESTABILIZADOR NISSAN TSURU I</p>	<p>6109</p>  <p>TORNILLO ESTABILIZADOR NISSAN URVAN</p>	<p>6119</p>  <p>BALERO BASE 1815, 1816 AUDI, SEAT, VW</p>	<p>6122</p>  <p>TOPE PARA SUSPENSIÓN TRASERA VW VARIOS</p>
<p>6123</p>  <p>TOPE PARA SUSPENSIÓN FRONTAL VW VARIOS</p>	<p>6124</p>  <p>TOPE PARA SUSPENSIÓN TRAS. CHEVROLET VARIOS</p>	<p>6126</p>  <p>TOPE PARA SUSPENSIÓN FRONTAL VW COMBI</p>	<p>6127</p>  <p>TOPE PARA SUSPENSIÓN FRONTAL INF. VW COMBI</p>	<p>6137</p>  <p>BALERO BASE (1808, 1852 1886, 1890, 7058 Y 7103) VW GOLF A2, GOLF A3 JETTA A2, JETTA A3</p>

<p>6138</p> <p>BALERO BASE DE AMORT. (1855, 6784) FORD ESCORT GUÍA, TEMPO, TOPAZ</p>	<p>6139</p> <p>BALERO BASE DE AMORT. FRONTAL IZQ. Y DER. 7427 HYUNDAI I10</p>	<p>6140</p> <p>BALERO BASE DE AMORT. (6650) CHRYSLER ARIES</p>	<p>6141</p> <p>BALERO BASE DE AMORT. (6641, 6758-KIT) CHRYSLER 600, ARIES</p>	<p>6142</p> <p>BALERO BASE AMORT. (6717, 6716, 7026, 7300-KIT) NISSAN SENTRA, TSURU II</p>
<p>6145</p> <p>BALERO BASE DE AMORT. FRONTAL IZQ. Y DER. VW JETTA, LUPO, SEAT IBIZA</p>	<p>6146</p> <p>BALERO BASE DE AMORT. FRONTAL 1829 FORD FIESTA, IKON, KA</p>	<p>6147</p> <p>BALERO BASE DE AMORT. NISSAN PLATINA, CLIO</p>	<p>6148</p> <p>BALERO BASE DE AMORT. FRONTAL 7029 MERCURY TRACER</p>	<p>6149</p> <p>BALERO BASE DE AMORT. FRONTAL 7357, 7410-KIT, 7411-KIT, NISSAN SENTRA, MICRA, TIIDA</p>
<p>6161</p> <p>SOPORTE PARA RADIADOR VW GOLF A2, JETTA A2</p>	<p>6162</p> <p>SOPORTE PARA FILTRO DE AIRE VW GOLF, JETTA</p>	<p>6300</p> <p>CUBRE POLVO DIR. STD. IZQ. VW CARIBE, ATLANTIC</p>	<p>6301</p> <p>CUBRE POLVO DIR. STD. DER. VW CARIBE, ATLANTIC</p>	<p>6302</p> <p>CUBRE POLVO LADO CAJA IZQ. Y DER. VW CARIBE, ATLANTIC</p>
<p>6303</p> <p>CUBRE POLVO LADO CAJA IZQ. Y DER., VW COMBI, PANEL</p>	<p>6304</p> <p>CUBRE POLVO LADO RUEDA IZQ. Y DER. FORD, CHEVROLET, RENAULT</p>	<p>6305</p> <p>CUBRE POLVO LADO RUEDA IZQ. Y DER. SEAT, HYUNDAI, NISSAN, VW</p>	<p>6306</p> <p>CUBRE POLVO LADO RUEDA IZQ. Y DER., CHRYSLER SPIRIT, SHADOW</p>	<p>6307</p> <p>CUBRE POLVO LADO CAJA IZQ. Y DER. VW SEDAN</p>
<p>6308</p> <p>CUBRE POLVO LADO CAJA IZQ. Y DER. FORD ECO-SPORT, HONDA CIVIC ACCORD</p>	<p>6309</p> <p>CUBRE POLVO LADO RUEDA IZQ. Y DER. NISSAN ALTIMA, SENTRA</p>	<p>6310</p> <p>CUBRE POLVO LADO CAJA IZQ. Y DER. CHEVROLET, CHRYSLER, NISSAN</p>	<p>6311</p> <p>CUBRE POLVO DIR. STD. IZQ. Y DER. CHEVROLET CHEVY, JOY</p>	<p>6312</p> <p>CUBRE POLVO LADO CAJA IZQ. Y DER. VW GOLF A4, JETTA A4</p>
<p>6313</p> <p>CUBRE POLVO LADO RUEDA IZQ. Y DER., HYUNDAI ATOS</p>	<p>6314</p> <p>CUBRE POLVO LADO CAJA IZQ. Y DER. VW JETTA A4, GOLF A4</p>	<p>6315</p> <p>CUBRE POLVO LADO RUEDA IZQ. Y DER. RENAULT, NISSAN, FORD</p>	<p>6316</p> <p>CUBRE POLVO LADO RUEDA IZQ. Y DER. CHRYSLER, FORD, RENAULT</p>	<p>6317</p> <p>CUBRE POLVO LADO CAJA IZQ. Y DER. VW SEDAN</p>



<p>6318</p>  <p>CUBRE POLVO LADO RUEDA IZQ. Y DER. CHRYSLER PT CRUISER, NEON</p>	<p>6319</p>  <p>CUBRE POLVO LADO CAJA IZQ. Y DER., FORD IKON, FIESTA, KA</p>	<p>6320</p>  <p>CUBRE POLVO LADO RUEDA IZQ. Y DER. FORD FOCUS</p>	<p>6321</p>  <p>CUBRE POLVO LADO RUEDA IZQ. Y DER. RENAULT R-5, R-9, R-12, R-18</p>	<p>6322</p>  <p>CUBRE POLVO LADO CAJA IZQ. Y DER. RENAULT R-5</p>
<p>6323</p>  <p>CUBRE POLVO LADO RUEDA IZQ. Y DER. RENAULT R-5, R-12</p>	<p>6324</p>  <p>CUBRE POLVO LADO CAJA IZQ. Y DER. RENAULT R-12</p>	<p>6325</p>  <p>CUBRE POLVO LADO CAJA IZQ. Y DER., RENAULT R-5, R-18</p>	<p>6326</p>  <p>CUBRE POLVO CAJA AUT. IZQ. Y DER. FORD FOCUS</p>	<p>6327</p>  <p>CUBRE POLVO LADO CAJA IZQ. FORD FOCUS, MONDEO</p>
<p>6328</p>  <p>CUBRE POLVO LADO CAJA IZQ. Y DER., NISSAN ROGUE, SENTRA, TSURU III</p>	<p>6329</p>  <p>CUBRE POLVO LADO CAJA DER., NISSAN PLATINA RENAULT CLIO</p>	<p>6330</p>  <p>CUBRE POLVO LADO CAJA IZQ. Y DER. FORD, NISSAN CHRYSLER, CHEVROLET</p>	<p>6331</p>  <p>CUBRE POLVO LADO CAJA IZQ., NISSAN PLATINA RENAULT CLIO</p>	<p>6332</p>  <p>CUBRE POLVO LADO CAJA IZQ. Y DER. (TRIPOIDE) PEUGEOT 206</p>
<p>6333</p>  <p>CUBRE POLVO LADO RUEDA IZQ. Y DER. CHRYSLER PT CRUISER</p>	<p>6334</p>  <p>CUBRE POLVO LADO CAJA IZQ. Y DER. CHRYSLER PT CRUISER</p>	<p>6335</p>  <p>CUBRE POLVO IZQ. DIR. STD. NISSAN TSURU III, LUCINO, SENTRA</p>	<p>6336</p>  <p>CUBRE POLVO DIR. STD., DER. NISSAN TSURU III, LUCINO, SENTRA</p>	<p>6337</p>  <p>CUBRE POLVO LADO RUEDA IZQ. Y DER., CHEVROLET, FORD, VW</p>
<p>6338</p>  <p>CUBRE POLVO LADO RUEDA IZQ. Y DER. CHEVROLET BLAZER Y S-10</p>	<p>6339</p>  <p>CUBRE POLVO LADO CAJA IZQ. Y DER., FORD FOCUS TOYOTA PICK UP 22R</p>	<p>6340</p>  <p>CUBRE POLVO LADO RUEDA IZQ. Y DER. TOYOTA PICK UP 22R</p>	<p>6341</p>  <p>CUBRE POLVO DIR. HID. IZQ. Y DER., FORD MUSTANG</p>	<p>6342</p>  <p>CUBRE POLVO DIR. HID. IZQ. Y DER. FORD FAIRMONT, COUGAR</p>
<p>6343</p>  <p>CUBRE POLVO LADO CAJA IZQ. Y DER. HYUNDAI ATOS</p>	<p>6344</p>  <p>CUBRE POLVO DIR. IZQ. VW POINTER</p>	<p>6345</p>  <p>CUBRE POLVO DIR. STD. IZQ. Y DER. CHEVROLET HYUNDAI, VW, NISSAN</p>	<p>6346</p>  <p>CUBRE POLVO LADO RUEDA IZQ. Y DER. CHEVROLET MATIZ, HYUNDAI VERNA</p>	<p>6347</p>  <p>CUBRE POLVO IZQ. Y DER. DIR. HID., NISSAN PLATINA, CLIO</p>

<p>6348</p>  <p>CUBRE POLVO IZQ. DIR. HID. NISSAN PLATINA, CLIO</p>	<p>6349</p>  <p>CUBRE POLVO LADO CAJA IZQ. Y DER., VW EUROVAN</p>	<p>6350</p>  <p>CUBRE POLVO LADO RUEDA IZQ. Y DER., CHYRSLER SPIRIT, VOLARE, LE BARON</p>	<p>6351</p>  <p>CUBRE POLVO LADO RUEDA IZQ. Y DER. NISSAN ALTIMA, CELEBRITY</p>	<p>6352</p>  <p>CUBRE POLVO IZQ. Y DER. DIR. STD., VW EUROVAN</p>
<p>6353</p>  <p>CUBRE POLVO DER. LADO CAJA, CHYRSLER VOLARE, SPIRIT, LE BARON</p>	<p>6354</p>  <p>CUBRE POLVO IZQ. Y DER. DIR. RENAULT R-5</p>	<p>6355</p>  <p>CUBRE POLVO IZQ. DIR. STD. NISSAN TSURU II, TSURU I</p>	<p>6356</p>  <p>CUBRE POLVO LADO CAJA IZQ. Y DER., RENAULT ENCORE, ALIANCE, R9</p>	<p>6357</p>  <p>CUBRE POLVO LADO CAJA IZQ. Y DER., CHEVROLET CITATION, CUTLASS</p>
<p>6358</p>  <p>CUBRE POLVO LADO CAJA IZQ. Y DER., CHEVROLET CITATION, CELEBRITY</p>	<p>6359</p>  <p>CUBRE POLVO LADO CAJA IZQ. Y DER., CHEVROLET CUTLASS, NISSAN ALTIMA</p>	<p>6360</p>  <p>CUBRE POLVO LADO RUEDA IZQ. Y DER., NISSAN TSURU I TSUBAME, LUCINO, SENTRA</p>	<p>6361</p>  <p>CUBRE POLVO IZQ. Y DER. DIR. HID., FORD COUGAR THUNDERBIRD</p>	<p>6362</p>  <p>CUBRE POLVO IZQ. Y DER. DIR., HYUNDAI ATOS</p>
<p>6363</p>  <p>CUBRE POLVO DER. DIR. STD. CHYRSLER VOLARE, LE BARON NEW YORKER, SHADOW</p>	<p>6364</p>  <p>CUBRE POLVO IZQ. Y DER. DIR. HID., CHYRSLER VOLARE LE BARON, NEW YORKER</p>	<p>6365</p>  <p>CUBRE POLVO DER. DIR. STD. NISSAN TSURU I, TSURU II</p>	<p>6366</p>  <p>CUBRE POLVO DER. DIR. HID. NISSAN TSURU I, TSURU II</p>	<p>6367</p>  <p>CUBRE POLVO IZQ. Y DER. DIR. STD., CHEVROLET CITATION, NISSAN URVAN</p>
<p>6368</p>  <p>CUBRE POLVO IZQ. Y DER. DIR. HID., CHEVROLET CITATION, CELEBRITY</p>	<p>6369</p>  <p>CUBRE POLVO IZQ. Y DER. DIR. HID., FORD TOPAZ</p>	<p>6370</p>  <p>CUBRE POLVO DIR. STD. DER. FORD TOPAZ</p>	<p>6371</p>  <p>CUBRE POLVO IZQ. DIR. STD. FORD TOPAZ</p>	<p>6372</p>  <p>CUBRE POLVO IZQ. Y DER. DIR. STD. FORD FAIRMONT</p>
<p>6373</p>  <p>CUBRE POLVO IZQ. Y DER. DIRECCIÓN STD. VW GOLF, JETTA</p>	<p>6374</p>  <p>CUBRE POLVO IZQ. Y DER. DIRECCIÓN HID. SEAT CORDOBA, VW GOLF</p>	<p>6375</p>  <p>CUBRE POLVO DER. LADO CAJA, CHYRSLER CHEVROLET, FORD, NISSAN</p>	<p>6376</p>  <p>CUBRE POLVO IZQ. Y DER. DIR. HID, NISSAN SENTRA LUCINO, TSURU II, TSUBAME</p>	<p>6377</p>  <p>CUBRE POLVO DIR. HID. IZQ. Y DER. FORD MUSTANG</p>



























<p>6378</p> <p>CUBRE POLVO IZQ. Y DER. LADO RUEDA, FORD COUGAR CHEVROLET CAVALIER Z-24</p>	<p>6379</p> <p>CUBRE POLVO IZQ. DIR. HID. NISSAN TSURU I, TSURU II</p>	<p>6380</p> <p>CUBRE POLVO IZQ. Y DER. LADO CAJA, CHRYSLER FORD/CHEVROLET</p>	<p>6381</p> <p>CUBRE POLVO IZQ. Y DER. DIR. HID., CHRYSLER SPIRIT PHANTOM, NEW YORKER</p>	<p>6382</p> <p>CUBRE POLVO IZQ. LADO CAJA, VW GOLF, JETTA SEAT CORDOBA, IBIZA, LEÓN</p>
<p>638</p> <p>CUBRE POLVO IZQUIERDO LADO CAJA VW GOLF, JETTA, DERBY</p>	<p>638</p> <p>CUBRE POLVO IZQ. Y DER. LADO RUEDA VW GOLF, BEETLE, JETTA</p>	<p>6385</p> <p>CUBRE POLVO, LADO RUEDA IZQ. Y DER., CHRYSLER NEON</p>	<p>6386</p> <p>CUBRE POLVO LADO CAJA DER., CHRYSLER NEON CRUSIER, FORD ESCORT, KA</p>	<p>6387</p> <p>CUBRE POLVO IZQ. Y DER. LADO CAJA, CHEVROLET CENTURY, CELEBRITY</p>
<p>6388</p> <p>CUBRE POLVO IZQ. Y DER. LADO CAJA, CHEVROLET CHEVY, JOY, POP, MONZA</p>	<p>6389</p> <p>CUBRE POLVO IZQ. Y DER. LADO CAJA RENAULT R-5 ALIANCE, R-9</p>	<p>6390</p> <p>CUBRE POLVO IZQ. Y DER. LADO CAJA, TSUBAME LUCINO, SENTRA</p>	<p>6391</p> <p>CUBRE POLVO IZQ. Y DER. LADO CAJA, CHRYSLER TAURUS, FORD GHIA</p>	<p>6392</p> <p>CUBRE POLVO IZQ. LADO RUEDA, FORD GUIA NISSAN TOPAZ, SENTRA</p>
<p>6393</p> <p>CUBRE POLVO IZQ. Y DER. LADO CAJA, CHEVROLET CELEBRITY FORD TOPAZ</p>	<p>6394</p> <p>CUBRE POLVO IZQ. Y DER. LADO RUEDA, CHEVROLET CELEBRITY, FORD TOPAZ</p>	<p>6395</p> <p>CUBRE POLVO IZQUIERDO LADO CAJA, VW JETTA VR-6</p>	<p>6396</p> <p>CUBRE POLVO IZQ. Y DER. LADO RUEDA CHRYSLER SPIRIT, SHADOW, PHANTOM</p>	<p>6397</p> <p>CUBRE POLVO IZQUIERDO LADO CAJA, CHRYSLER FORD, NISSAN</p>
<p>6398</p> <p>CUBRE POLVO IZQUIERDO LADO CAJA, NISSAN SENTRA CHRYSLER CIRRUS</p>	<p>6399</p> <p>CUBRE POLVO IZQ. Y DER. DIRECCIÓN HID., FORD GUIA, TOPAZ, WINDSTAR</p>	<p>6402</p> <p>GOMA PARA BARRA ESTABILIZADORA CHEVROLET, CAVALIER</p>	<p>6403</p> <p>GOMA PARA BARRA ESTABILIZADORA CHEVROLET, CAVALIER</p>	<p>6404</p> <p>GOMA PARA BARRA ESTAB. CHEVROLET, CAVALIER MALIBU</p>
<p>6405</p> <p>GOMA PARA BARRA ESTABILIZADORA CHEVROLET CHEVY</p>	<p>6406</p> <p>GOMA PARA BARRA ESTABILIZADORA CHEVROLET C-10</p>	<p>6407</p> <p>GOMA PARA BARRA ESTABILIZADORA CHRYSLER RAM</p>	<p>6408</p> <p>GOMA PARA BARRA ESTABILIZADORA FORD FAIRMONT</p>	<p>6409</p> <p>GOMA PARA BARRA ESTABILIZADORA FORD CAMIONETAS</p>



<p>6410</p>  <p>GOMA PARA BARRA ESTABILIZADORA FORD CAMIONETAS</p>	<p>6411</p>  <p>GOMA PARA BARRA ESTABILIZADORA FORD CAMIONETAS</p>	<p>6412</p>  <p>GOMA PARA BARRA ESTABILIZADORA FORD MUSTANG</p>	<p>6413</p>  <p>GOMA PARA BARRA ESTABILIZADORA CHRYSLER SHADOW</p>	<p>6414</p>  <p>GOMA PARA BARRA ESTABILIZADORA CHRYSLER SHADOW, SPIRIT</p>
<p>6415</p>  <p>GOMA PARA BARRA ESTABILIZADORA NISSAN TSURU II</p>	<p>6416</p>  <p>GOMA PARA BARRA ESTABILIZADORA NISSAN TSURU I</p>	<p>6417</p>  <p>GOMA PARA BARRA ESTABILIZADORA NISSAN TSURU III</p>	<p>6418</p>  <p>GOMA PARA BARRA ESTABILIZADORA RAMBLER VARIOS</p>	<p>6419</p>  <p>GOMA PARA BARRA ESTABILIZADORA CHRYSLER CAMIONETAS</p>
<p>6421</p>  <p>GOMA PARA BARRA ESTAB. NISSAN PLATINA RENAULT MEGANE 1</p>	<p>6422</p>  <p>GOMA PARA BARRA ESTABILIZADORA FORD TOPAZ</p>	<p>6423</p>  <p>GOMA PARA BARRA ESTABILIZADORA CHRYSLER DART K</p>	<p>6424</p>  <p>GOMA PARA BARRA ESTABILIZADORA CHEVROLET/ CITATION</p>	<p>6425</p>  <p>GOMA PARA BARRA ESTABILIZADORA CHEVROLET CENTURY, CITATION, CUTLASS</p>
<p>6426</p>  <p>SOPORTE PARA RADIADOR VW CARIBE</p>	<p>6430</p>  <p>GOMA PARA BARRA ESTABILIZADORA CHRYSLER CAMIONETAS</p>	<p>6431</p>  <p>GOMA PARA BARRA ESTABILIZADORA CHRYSLER CAMIONETAS</p>	<p>6436</p>  <p>GOMA PARA BARRA ESTAB. PEUGEOT 206</p>	<p>6541</p>  <p>GOMA SUJETADORA DE ESCAPE VW ATLANTIC, CARIBE</p>
<p>6542</p>  <p>GOMA SUJETADORA DE ESCAPE, VW SEDAN</p>	<p>6543</p>  <p>GOMA SUJETADORA DE ESCAPE, VW SEDAN</p>	<p>6544</p>  <p>GOMA MULTIPLE DE ADMISION, VW SEDAN</p>	<p>6545</p>  <p>GOMA SUJETADORA DE ESCAPE, RENAULT VARIOS</p>	<p>6546</p>  <p>GOMA SUJETADORA DE ESCAPE, CHRYSLER PHANTOM, SHADOW</p>
<p>6547</p>  <p>GOMA ABIERTA PARA MULTIPLE DE ADMISION VW SEDAN</p>	<p>6548</p>  <p>GOMA SUJETADORA DE ESCAPE CHRYSLER MAGNUM K, VOLARE K LEBARON K</p>	<p>6549</p>  <p>GOMA SUJETADORA DE ESCAPE CHRYSLER MAGNUM K, VOLARE K</p>	<p>6551</p>  <p>CUBRE POLVO PARA PALANCA DE VELOCIDADES FORD MUSTANG</p>	<p>6553</p>  <p>CUBRE POLVO PARA PALANCA DE VELOCIDADES NISSAN TSURU I, TSURU II</p>



6554  CUBRE POLVO PARA PALANCA DE VELOCIDADES CHRYSLER DART K	6556  CUBRE POLVO PARA PALANCA DE VELOCIDADES CHRYSLER VARIOS	6561  GOMA SUJETADORA DE ESCAPE MERCURY GRAND MARQUIS	6562  GOMA SUJETADORA DE ESCAPE CHEVROLET CAVALIER	6563  GOMA SUJETADORA DE ESCAPE VW JETTA A2, GOLF A2
6564  GOMA SUJETADORA DE ESCAPE VW GOLF A3, JETTA A3	6565  GOMA SUJETADORA DE ESCAPE, CHRYSLER NEON	6566  GOMA SUJETADORA DE ESCAPE CHRYSLER RAM 2500, 3500	6567  GOMA SUJETADORA DE ESCAPE, FORD F-250, LOBO	6569  GOMA SUJETADORA DE ESCAPE AUDI A3, VW POINTER
6571  GOMA SUJETADORA DE ESCAPE, FORD FOCUS	6572  GOMA SUJETADORA DE ESCAPE CHRYSLER STRATUS	6573  GOMA SUJETADORA DE ESCAPE CHEVROLET ASTRA, CHEVY	6574  GOMA P/BARRA ESTAB. SEAT IBIZA, LEÓN	6611  SOP. TRANSMISIÓN VW COMBI, PANEL
6617  SOPORTE PARA RADIADOR VW CARIBE, ATLANTIC	6620  SOP. MOTOR IZQUIERDO FORD CROWN VICTORIA GRAND MARQUIS	6621  SOP. MOTOR DERECHO FORD CROWN VICTORIA GRAND MARQUIS	6622  SOP. TRANSMISIÓN FORD CROWN VICTORIA GRAND MARQUIS	6623  SOP. MOTOR IZQUIERDO FORD THUNDERBIRD COUGAR
6627  SOP. MOTOR DERECHO RENAULT R-5	6633-H  SOP. MOTOR DERECHO CHEVROLET CENTURY, CELEBRITY	6636  BASE FRONTAL IZQ. Y DER. CHRYSLER SHADOW, SPIRIT	6640  SOP. MOTOR IZQ. Y DER. CHEVROLET BLAZER, S-10	6641  BASE FRONTAL IZQ. Y DER. CHRYSLER NEW YORKER, LE BARON K
6642  REP. SOP. TRANS. (6655) CHEVROLET CAVALIER Z-24 PONTIAC GRAND AM	6647  SOP. MOTOR TRASERO CHEVROLET CAVALIER Z-24 PONTIAC GRAND AM	6650, 6650-KIT  BASE FRONTAL IZQ. Y DER. CHRYSLER SHADOW, SPIRIT CARAVAN, VOYAGER	6651  SOP. MOTOR FRONTAL CHRYSLER SHADOW, SPIRIT CARAVAN, VOYAGER	6652  SOP. MOTOR DERECHO CHRYSLER SHADOW, SPIRIT CARAVAN, VOYAGER

<p>6653</p>  <p>SOP. TRANSMISIÓN CHRYSLER SERIES D100-350</p>	<p>6655</p>  <p>SOP. TRANSMISIÓN CHEVROLET CAVALIER, Z-24</p>	<p>6658</p>  <p>SOP. MOTOR FRONTAL STD. SEAT IBIZA, LEON, TOLEDO VW GOLF A2, JETTA, PASSAT</p>	<p>6659</p>  <p>SOP. MOTOR DERECHO SEAT IBIZA, LEON, TOLEDO VW GOLF A2, JETTA, PASSAT</p>	<p>6660</p>  <p>SOP. TRANSMISIÓN STD. SEAT IBIZA, LEON, TOLEDO VW GOLF A2, JETTA, PASSAT</p>
<p>6661</p>  <p>SOP. MOTOR FRONTAL SEAT CORDOBA, IBIZA, VW GOLF A3, JETTA A3, PASSAT</p>	<p>6662</p>  <p>SOP. MOTOR TRASERO SEAT CORDOBA, IBIZA, VW GOLF A3, JETTA A3, PASSAT</p>	<p>6663</p>  <p>SOP. TRANS. STD. SEAT CORDOBA, IBIZA, DERBY GOLF, JETTA, PASSAT</p>	<p>6663-S</p>  <p>SOP. TRANS. STD. SEAT CORDOBA, IBIZA, VW GOLF A3, JETTA A3, PASSAT</p>	<p>6665</p>  <p>SOP. MOT. DERECHO NISSAN TSURU I</p>
<p>6666, 6666KIT</p>  <p>BASE FRONTAL IZQ. Y DER. CHEVROLET CELEBRITY CUTLASS</p>	<p>6667, 6667KIT</p>  <p>BASE FRONTAL IZQ. Y DER. CHEVROLET CELEBRITY CUTLASS</p>	<p>6668</p>  <p>SOP. TRANSMISIÓN CHRYSLER SHADOW, SPIRIT VOYAGER, CARAVAN</p>	<p>6669</p>  <p>SOP. MOTOR DER. CHRYSLER NEON PLYMOUTH BREEZE</p>	<p>6669-9</p>  <p>REP. SOP. MOTOR DER. (6669) CHRYSLER NEON PLYMOUTH BREEZE</p>
<p>6670</p>  <p>SOP. TRANSMISIÓN AUT. CHRYSLER NEON</p>	<p>6671</p>  <p>SOP. TRANSMISIÓN STD. CHRYSLER NEON PLYMOUTH BREEZE</p>	<p>6674</p>  <p>SOP. MOTOR TRASERO FORD TAURUS, WINDSTAR</p>	<p>6674-H</p>  <p>SOP. MOTOR TRASERO FORD TAURUS, WINDSTAR</p>	<p>6675</p>  <p>SOP. MOTOR FRONTAL FORD TAURUS, WINDSTAR</p>
<p>6675-H</p>  <p>SOP. MOTOR FRONTAL FORD TAURUS, WINDSTAR</p>	<p>6676</p>  <p>SOP. MOTOR IZQ. Y DER. NISSAN D-21, FRONTIER, X-TERRA</p>	<p>6677</p>  <p>SOP. TRANSMISIÓN NISSAN D-21, FRONTIER, PATHFINDER</p>	<p>6679</p>  <p>SOP. TRANSMISIÓN VW CORSAR</p>	<p>6682</p>  <p>SOP. MOTOR FRONTAL CHRYSLER NEON</p>
<p>6683</p>  <p>REP. MOT. SOP. FRONTAL (6682) CHRYSLER NEON</p>	<p>6684</p>  <p>SOP. MOTOR FRONTAL STD. NISSAN TSURU III, TSUBAME</p>	<p>6685</p>  <p>SOP. TRANSMISIÓN NISSAN TSURU III, TSUBAME</p>	<p>6686</p>  <p>SOP. MOTOR DERECHO NISSAN TSURU III, TSUBAME</p>	<p>6687, 6687-KIT</p>  <p>BASE FRONTAL IZQ. Y DER. VW CORSAR</p>



6688 SOP. TRANSMISIÓN NISSAN TSURU III, TSUBAME	6689 REP. SOP. MOT. FRONTAL (6684) NISSAN TSURU III, TSUBAME	6691 SOP. MOTOR DER. FORD GUIA, TOPAZ, TEMPO	6692 SOP. MOTOR FRONTAL AUT. VW DERBY, GOLF A2 JETTA A2	6693 SOP. TRANSMISIÓN AUT. SEAT CORDOBA, IBIZA, VW GOLF A2, GOLF A3, JETTA A2
6694 SOP. MOTOR TRASERO NISSAN GSR, TSURU III, TSUBAME	6695 SOP. TRANSMISIÓN CHRYSLER INTREPID, CONCORD	6698 SOP. MOT. FRONTAL Y TRAS. CHRYSLER STRATUS, CIRRUS	6700 SOP. TRANSMISIÓN CHRYSLER NEY YORKER, PHANTOM	6701 SOP. MOTOR DERECHO FORD CROWN VICTORIA LINCOLN TOWNCAR
6702 SOP. MOTOR IZQUIERDO FORD CROWN VICTORIA LINCOLN TOWNCAR	6703 SOP. MOTOR DERECHO FORD CONTOUR	6704-9 REP. SOP. MOT. FRONT. (6704) FORD CONTOUR, MYSTIQUE	6705-9 REPUESTO PARA 6705 FORD CONTOUR, MYSTIQUE	6706 SOP. TRANSMISIÓN AUT. FORD CONTOUR, MYSTIQUE
6707 SOP. TRANSMISIÓN STD. FORD CONTOUR, MYSTIQUE	6707-9 REP. SOP. TRANS. STD. Y AUT. (6706, 6407, 6940, 6941) FORD CONTOUR, MYSTIQUE	6710, 6710-KIT BASE FRONTAL IZQ. Y DER. OLDSMOBILE CUTLASS CALAIS	6711, 6711-KIT BASE FRONTAL IZQ. Y DER. CHEVROLET CAVALIER Z-24 PONTIAC SUNBIRD	6712 SOP. TRANSMISIÓN TRAS. FORD TEMPO, TOPAZ
6712-9 REP. SOP. TRANS. TRAS. (6712) FORD TEMPO, TOPAZ	6714 SOP. TRANSMISIÓN TRASERO FORD CONTOUR, MYSTIQUE	6714-9 REP. SOP. MOT. TRAS. 6714 FORD CONTOUR, MYSTIQUE	6715, 6715-KIT BASE TRASERA IZQ. Y DER. FORD TOPAZ, GHIA, TEMPO	6716, 6716-KIT REP. BASE FRONT. IZQ. Y DER. SENTRA LUCINO, TSURU II, SENTRA
6717, 6717-KIT BASE FRONTAL IZQ. Y DER. NISSAN LUCINO, TSURU II, SENTRA	6718, 6718-KIT BASE TRASERA IZQ. Y DER. NISSAN TSURU III	6720, 6720-KIT BASE FRONTAL IZQ. Y DER. PONTIAC GRAND PRIX	6726, 6726-KIT BASE FRONTAL IZQ. Y DER. BUICK ELECTRA PONTIAC BONEVILLE	6727, 6727-KIT BASE FRONTAL DERECHA CHEVROLET CAMARO PONTIAC FIREBIRD

<p>6728, 6728-KIT</p>  <p>BASE FRONTAL IZQUIERDA CHEVROLET CAMARO</p>	<p>6729-KIT</p>  <p>REP. BASE FRONTAL IZQ. Y DER., (6741, 6741-KIT, 6142 Y 6142-KIT), FORD COUGAR</p>	<p>6730, 6730-KIT</p>  <p>BASE FRONTAL IZQ. Y DER. FORD TAURUS, SABLE</p>	<p>6731, 6731-KIT</p>  <p>BASE FRONTAL IZQ. Y DER. CHEVROLET CAVALIER, Z-24</p>	<p>6732, 6732-KIT</p>  <p>BASE TRASERA IZQ. Y DER. CADILLAC FLEETWOOD</p>
<p>6733, 6733-KIT</p>  <p>BASE TRASERA IZQ. Y DER. FORD TAURUS</p>	<p>6734-KIT</p>  <p>BASE TRASERA IZQ. Y DER. FORD ESCORT</p>	<p>6735, 6735-KIT</p>  <p>BASE TRASERA IZQ. Y DER. BUICK REGAL</p>	<p>6736-KIT</p>  <p>BASE FRONTAL IZQ. Y DER. HONDA, ACCORD</p>	<p>6737, 6737-KIT</p>  <p>BASE TRASERA IZQ. Y DER. FORD ESCORT</p>
<p>6738, 6738-KIT</p>  <p>BASE TRASERA IZQ. Y DER. BMW SERIES 318, 320</p>	<p>6739, 6739-KIT</p>  <p>BASE TRASERA IZQ. Y DER. VW CARIBE, ATLANTIC DERBY, GOLF, JETTA</p>	<p>6740, 6740-KIT</p>  <p>BASE FRONTAL IZQ. Y DER. FORD COUGAR, THUNDERBIRD</p>	<p>6741, 6741-KIT</p>  <p>BASE FRONTAL IZQ. Y DER. FORD COUGAR, THUNDERBIRD</p>	<p>6742, 6742-KIT</p>  <p>BASE FRONTAL IZQ. Y DER. FORD THUNDERBIRD, COUGAR</p>
<p>6743, 6743-KIT</p>  <p>BASE FRONTAL IZQ. Y DER. NISSAN STANZA, ALTIMA</p>	<p>6744, 6744-KIT</p>  <p>BASE TRASERA IZQ. Y DER. CHRYSLER INTREPID, CONCORD</p>	<p>6745, 6745-KIT</p>  <p>BASE FRONTAL IZQ. Y DER. CHRYSLER CONCORD, INTREPID</p>	<p>6746, 6746-KIT</p>  <p>BASE FRONTAL IZQ. Y DER. BMW SERIE 3</p>	<p>6747, 6747-KIT</p>  <p>BASE FRONTAL IZQ. Y DER. BMW SERIE 3, SERIE 5, X3</p>
<p>6748, 6748-KIT</p>  <p>BASE FRONTAL IZQ. Y DER. CHRYSLER NEON</p>	<p>6749, 6749-KIT</p>  <p>BASE TRASERA IZQ. Y DER. CHRYSLER NEON</p>	<p>6750, 6750-KIT</p>  <p>BASE TRASERA IZQ. Y DER. CHRYSLER CIRRUS, STRATUS</p>	<p>6751, 6751-KIT</p>  <p>BASE FRONTAL DER. CHEVROLET CAMARO PONTIAC FIREBIRD</p>	<p>6752, 6752-KIT</p>  <p>BASE TRASERA IZQ. Y DER. CHEVROLET CAVALIER Z-24 PONTIAC SUNFIRE</p>
<p>6753, 6753-KIT</p>  <p>BASE FRONTAL IZQ. Y DER. FORD CONTOUR, MYSTIQUE</p>	<p>6754, 6754-KIT</p>  <p>BASE TRASERA IZQ. Y DER. FORD CONTOUR, MYSTIQUE</p>	<p>6755</p>  <p>BASE FRONTAL IZQ. Y DER. CHRYSLER, HONDA</p>	<p>6756</p>  <p>SOPORTE PARA AIRE ACONDICIONADO FORD GHIA</p>	<p>6757</p>  <p>BASE FRONTAL IZQ. Y DER. VW CORSAR</p>



6758-KIT  BASE FRONTAL IZQ. Y DER. CHRYSLER LE BARON K, NEW YORKER	6759, 6759-KIT  BASE FRONTAL IZQ. Y DER. VW GOLF, JETTA A-3	6760, 6760-KIT  BASE FRONTAL IZQ. Y DER. SUP., CHEVROLET CHEVY JOY, SWING	6761, 6761-KIT  BASE FRONTAL IZQ. CHEVROLET CAMARO PONTIAC FIREBIRD	6762  BASE FRONTAL IZQ. Y DER. INF., CHEVROLET CHEVY JOY, SWING
6763  REPUESTO SOP. (6670 Y 6671) CHRYSLER NEON PLYMOUTH BREEZE	6764  SOP. MOTOR DERECHO FORD F-100, F-150, VAM	6766  SOP. TRANSMISIÓN STD. Y AUT CHEVROLET C-10, C-15	6768  SOP. MOTOR IZQ. Y DER. JEEP CHEROKEE WAGONEER	6769  SOP. MOTOR IZQUIERDO FORD F-100, F-150, F-350
6770  SOPORTE TRANSMISIÓN BUICK LE SABRE CHEVROLET CAMARO	6771  SOP. MOTOR IZQ. Y DER. CHEVROLET S-10, S-15	6773  SOP. MOTOR IZQ. Y DER. JEEP C-J, CHEROKEE	6774  SOP. TRANSMISIÓN CHEVROLET ASTRO, BLAZER PONTIAC FIREBIRD	6775  SOP. MOTOR FRONTAL HONDA ACCORD ODYSSEY
6777  SOP. MOTOR DERECHO CHEVROLET CAVALIER	6778  SOP. TORSIÓN FRONTAL CHEVROLET CENTURY CUTLASS	6779  SOP. TRANS. FRONTAL IZQ. BUICK, CADILLAC CHEVROLET, PONTIAC	6781  SOPORTE TORSIÓN FRONTAL BUICK LE SABRE CHEVROLET CENTURY	6782  SOP. TRANSMISIÓN FORD TEMPO
6784, 6784-KIT  BASE FRONTAL IZQ. Y DER. FORD TOPAZ, GHIA	6785  REP. SOP. MOT. (6698 Y 6899) TRASERO CHRYSLER CIRRUS, STRATUS	6786  SOP. MOTOR IZQUIERDO FORD GRANADA	6787  REP. SOP. MOTOR FRONTAL (6698, 6900 y 6901) CHRYSLER CIRRUS, STRATUS	6788  SOP. MOTOR DERECHO FORD MUSTANG THUNDERBIRD
6790  SOP. MOTOR IZQUIERDO CHEVROLET CENTURY, MALIBU	6791  SOP. MOTOR DERECHO CHEVROLET CENTURY, MALIBU	6792  SOP. TRANSMISIÓN CHEVROLET CAMARO, CAPRICE	6795  SOP. MOTOR TRASERO DER. CHEVROLET CORSICA PONTIAC GRAND AM	6796  SOP. MOTOR IZQUIERDO FORD MUSTANG

<p>6797</p>  <p>SOP. MOTOR DERECHO FORD MUSTANG</p>	<p>6799</p>  <p>SOP. MOTOR IZQ. Y DER. PERKINS CHRYSLER SERIE CT 800</p>	<p>6800</p>  <p>SOP. TRANS. UNIVERSAL CHEVROLET C-10, C-15</p>	<p>6801</p>  <p>SOP. MOTOR DERECHO NISSAN TSURU III, LUCINO</p>	<p>6802</p>  <p>SOP. MOTOR DERECHO NISSAN TSURU III, TSUBAME</p>
<p>6803</p>  <p>SOP. TRANSMISIÓN STD. NISSAN TSURU II</p>	<p>6804</p>  <p>SOP. TRANSMISIÓN NISSAN GSR, LUCINO, TSURU III</p>	<p>6805</p>  <p>SOP. TRANSMISIÓN TRASERO NISAN SENTRA</p>	<p>6806</p>  <p>SOP. MOTOR TRASERO AUT. NISSAN SENTRA</p>	<p>6807</p>  <p>SOP. MOTOR TRASERO NISSAN LUCINO, SENTRA</p>
<p>6808</p>  <p>SOP. TRANSMISIÓN HONDA CIVIC</p>	<p>6809</p>  <p>SOP. TRANSMISIÓN HONDA ACCORD</p>	<p>6810</p>  <p>SOP. MOTOR TRASERO HONDA CIVIC</p>	<p>6815</p>  <p>SOP. MOTOR TRASERO HONDA ACCORD</p>	<p>6815-H</p>  <p>SOP. MOTOR TRASERO HONDA ACCORD</p>
<p>6816</p>  <p>SOP. MOTOR IZQUIERDO HONDA ACCORD</p>	<p>6817</p>  <p>SOP. MOTOR IZQUIERDO HONDA CIVIC</p>	<p>6818</p>  <p>SOP. MOTOR FRONTAL HONDA CIVIC</p>	<p>6819</p>  <p>SOP. MOTOR IZQUIERDO HONDA CIVIC</p>	<p>6821</p>  <p>REP. SOP. TRANSMISIÓN (6805 Y 6824) NISSAN TSURU II, SENTRA</p>
<p>6822</p>  <p>REP. SOP. TRANS. STD. NISSAN TSURU II</p>	<p>6823</p>  <p>BASE PARA CARBURADOR VW GOLF, JETTA</p>	<p>6824</p>  <p>SOP. TRANS. TRASERO NISSAN TSURU III</p>	<p>6825</p>  <p>SOPORTE P/PALANCA DE VELOCIDADES NISSAN TSURU I</p>	<p>6826</p>  <p>SOPORTE P/PALANCA DE VELOCIDADES NISSAN TSURU II</p>
<p>6827</p>  <p>SOPORTE P/PALANCA DE VELOCIDADES NISSAN TSURU III</p>	<p>6828</p>  <p>SOP. TRANSMISIÓN, FORD COUGAR, THUNDERBIRD</p>	<p>6829</p>  <p>SOP. TRANS. STD. Y AUT. SEAT IBIZA, CORDOBA</p>	<p>6830</p>  <p>SOPORTE ALTERNADOR CHRYSLER SPIRIT, SHADOW</p>	<p>6831</p>  <p>SOPORTE TRANSMISIÓN CHRYSLER DAKOTA JEEP CHEROKEE</p>

































6832  SOP. MOTOR DER. JEEP CHEROKEE	6833  SOP. TRANSMISIÓN IMP. JEEP CHEROKEE	6834  SOP. TRANSMISIÓN FORD ESCORT	6834-9  REPUESTO PARA 6834 FORD ESCORT	6835  SOP. MOTOR FRONTAL FORD ESCORT
6835-9  REPUESTO PARA (6835) FORD ESCORT	6837-H  REP. SOP. MOTOR DERECHO CHEVROLET CAVALIER, SUNFIRE	6837-9  COMPLEMENTO SOP. (6837-H) CHEV. CAVALIER, SUNFIRE	6838-H  SOP. MOTOR DERECHO BUICK REGAL CHEVROLET CUTLASS	6839-H  SOP. MOTOR FRONTAL FORD WINSTAR
6840  SOPORTE TRANSMISIÓN CHRYSLER INTREPID, NEW YORK, 300 M	6841  SOP. MOT. FRONTAL C/BASE VW GOLF, JETTA A2	6842  SOP. MOT. TRASERO C/BASE SEAT CORDOBA VW GOLF, JETTA A3	6843  SOP. TRANSMISIÓN AUTO CHEVROLET CAVALIER PONTIAC SUNFIRE	6844  SOP. TRANSMISIÓN BUICK, CHEVROLET OLDSMOBILE, PONTIAC
6845  SOP. TRANSMISIÓN TRAS. FORD ESCORT	6845-9  REP. DE SOP. TRANS. (6845) FORD ESCORT	6846-H  SOP. MOTOR FRONTAL DER. FORD SABLE, TAURUS	6847-H  SOP. MOTOR FRONTAL DER. FORD TAURUS, SABLE	6848-H  SOP. MOTOR IZQ. Y DER. CHRYSLER INTREPID, CONCORDE
6849  SOPORTE TRANSMISIÓN CHRYSLER STRATUS, CIRRUS	6850  SOP. MOTOR DER. FRONTAL FORD ESCORT	6851  SOP. MOTOR DERECHO CHRYSLER STRATUS, CIRRUS	6853  SOP. MOTOR FRONTAL) DER. INF. (BUJE CORTO CHEVROLET CAVALIER	6854  SOP. MOTOR DERECHO NISSAN TSURU III, TSUBAME
6856  SOP. MOTOR FRONTAL STD. FORD CONTOUR MYSTIQUE	6857  SOP. MOTOR FRONTAL AUT. FORD CONTOUR MYSTIQUE	6858  SOP. MOTOR IZQ. Y DER. MAZDA B2000, B2200	6859  SOP. MOTOR IZQ. Y DER. TOYOTA PICK UP	6860  SOP. TRANSMISIÓN TOYOTA TERCEL

<p>6861</p>  <p>SOP. TRANSMISIÓN FORD PROBE, MAZDA 626</p>	<p>6862</p>  <p>SOP. TRANSMISIÓN AUT. MITSUBISHI ECLIPSE, GALANT</p>	<p>6866</p>  <p>SOP. MOTOR IZQ. Y DER. FORD GRANADA</p>	<p>6868</p>  <p>SOP. MOTOR DERECHO FORD CLUB WAGON, E-100</p>	<p>6869</p>  <p>SOP. MOTOR IZQUIERDO FORD CLUB WAGON, E-100</p>
<p>6870</p>  <p>SOP. MOTOR DERECHO FORD BRONCO, CLUB WAGON</p>	<p>6871</p>  <p>SOP. MOTOR IZQUIERDO FORD BRONCO, CLUB WAGON</p>	<p>6872</p>  <p>SOP. MOTOR DERECHO CHEVROLET CUTLASS PONTIAC GRAND AM</p>	<p>6873</p>  <p>SOP. MOTOR IZQ. Y DER. CHEVROLET BLAZER</p>	<p>6874</p>  <p>SOP. TRANSMISIÓN CHEVROLET BLAZER, C-10</p>
<p>6875-H</p>  <p>SOP. MOTOR DERECHO BUICK ALLURE, CHEVROLET IMPALA, PONTIAC MONTANA</p>	<p>6876</p>  <p>SOP. TRANSMISIÓN CHEVROLET ASTRO, S-10, S-15</p>	<p>6877</p>  <p>SOPORTE TRANSMISIÓN FORD TAURUS</p>	<p>6878</p>  <p>SOPORTE TRANSMISIÓN FORD TAURUS</p>	<p>6881</p>  <p>SOP. MOTOR DERECHO JEEP CHEROKEE</p>
<p>6882</p>  <p>SOP. MOTOR IZQUIERDO JEEP CHEROKEE</p>	<p>6883</p>  <p>SOP. MOTOR DERECHO JEEP CHEROKEE</p>	<p>6884</p>  <p>SOP. MOTOR DERECHO FORD EXPLORER, RANGER</p>	<p>6885</p>  <p>SOP. MOTOR DERECHO FORD GALAXI</p>	<p>6886</p>  <p>SOP. MOTOR IZQUIERDO FORD GALAXI</p>
<p>6887</p>  <p>SOP. TRANSMISIÓN CHEVROLET CHEVELLE</p>	<p>6888</p>  <p>SOP. MOTOR DERECHO CHEVROLET C-10, CAPRICE</p>	<p>6889</p>  <p>SOP. MOTOR IZQUIERDO CHEVROLET C-10, CAPRICE</p>	<p>6890</p>  <p>SOPORTE TRANSMISIÓN FORD AEROSTAR, RANGER</p>	<p>6891</p>  <p>SOP. MOTOR DERECHO FORD BRONCO II MAZDA NAVAJO</p>
<p>6892</p>  <p>SOP. MOTOR IZQUIERDO FORD BRONCO II MAZDA NAVAJO</p>	<p>6893-H</p>  <p>SOP. MOTOR IZQ. Y DER. FORD BRONCO II, RANGER</p>	<p>6897</p>  <p>SOP. MOTOR IZQUIERDO JEEP GRAND CHEROKEE</p>	<p>6899</p>  <p>SOP. MOTOR TRASERO CHRYSLER STRATUS, CIRRUS</p>	<p>6900</p>  <p>SOP. MOTOR FRONTAL CHRYSLER STRATUS, CIRRUS</p>



6901 SOP. MOTOR FRONTAL CHRYSLER CIRRUS, STRATUS	6902 SOP. MOTOR DER. INFERIOR CHRYSLER NEON PT CRUISER	6902-9 REPUESTO SOPORTE DER. INF. (6902) CHRYSLER NEON, PT CRUISER	6903 SOP. MOTOR DER. SUPERIOR CHRYSLER NEON, PT CRUISER	6903-9 REPUESTO SOPORTE DER. SUPERIOR (6903) CHRYSLER NEON, PT CRUISER
6904 SOPORTE DE TORSIÓN HYUNDAI EXCEL	6905 SOP. MOTOR DER. FRONTAL CHEVROLET CHEVY, TORNADO	6906 BASE DE AMORT. TRAS. VW GOLF, JETTA A-4, BEETLE	6907 SOP. TRANSMISIÓN VW POINTER	6908 SOP. MOTOR IZQ. Y DER. FORD FALCON
6909 SOP. MOTOR IZQ. CHEVROLET CAMARO, BLAZER, S10	6910 SOP. MOTOR TRASERO DER. FORD SABLE, TAURUS	6911 SOP. MOTOR DERECHO FORD RANGER	6914 SOP. MOTOR IZQ. Y DER. CHEVROLET BLAZER	6916 SOP. TRANSMISIÓN PONTIAC FIREBIRD
6918-H SOP. MOTOR FRONTAL DER. CHEVROLET MONTE CARLO	6919 REP. SOP. MOTOR FRONTAL (1871 Y 1872) FORD GHIA	6920 SOP. TRANSMISIÓN BUICK REGAL, IMPALA	6923 SOPORTE TRANSMISIÓN FORD BRONCO II, RANGER	6924 SOP. TRANSMISIÓN FORD BRONCO II, RANGER
6928 SOPORTE MOTOR FRONTAL BUICK ELECTRA	6931 SOP. MOTOR IZQ. Y DER. CHEVROLET DENALI, SONORA	6932 SOP. MOTOR DERECHO FORD AEROSTAR	6933 SOP. MOTOR IZQUIERDO FORD AEROSTAR	6934 SOP. MOTOR IZQUIERDO CHRYSLER DAKOTA
6936 SOPORTE MOTOR FRONTAL DER. INF. PONTIAC SUNFIRE	6937 SOP. TRANSMISIÓN FORD ESCORT	6938 SOP. MOTOR FRONTAL CHRYSLER VOYAGER	6939 SOP. MOTOR FRONTAL FORD CONTOUR	6940 SOPORTE TRANSMISIÓN FORD MYSTIQUE

<p>6941</p>  <p>REP. SOP. TRANSMISIÓN FORD CONTOUR, MYSTIQUE</p>	<p>6942</p>  <p>SOP. MOTOR DERCHO CHRYSLER CARAVAN, VOYAGER</p>	<p>6943</p>  <p>SOP. MOTOR DER. CHRYSLER NEON, PT CRUISER</p>	<p>6944</p>  <p>SOP. TRANSMISIÓN AUT. CHRYSLER NEON</p>	<p>6945</p>  <p>SOP. MOTOR TRASERO TOYOTA CAMRY</p>
<p>6946</p>  <p>SOP. TRANSMISIÓN TOYOTA CAMRY</p>	<p>6948</p>  <p>SOP. MOTOR DERECHO FORD BRONCO II, RANGER</p>	<p>6949</p>  <p>SOP. TRANSMISIÓN JEEP GRAND CHEROKEE</p>	<p>6950</p>  <p>REP. SOP. MOTOR DER. (6942) CHRYSLER VOYAGER</p>	<p>6951</p>  <p>REP. SOP. MOTOR FRONTAL (7127) HYUNDAI, ATOS</p>
<p>6952</p>  <p>REP. SOPORTE TRANS. (7245) HYUNDAI ATOS</p>	<p>6953</p>  <p>REP. SOPORTE MOTOR TRAS. (7246) HYUNDAI ATOS</p>	<p>6954</p>  <p>BASE FRONTAL IZQ. Y DER. HYUNDAI ATOS</p>	<p>6958</p>  <p>SOP. MOTOR TRASERO FORD PROBE</p>	<p>6959</p>  <p>SOP. MOTOR TRAS. AUT. FORD PROBE</p>
<p>6960</p>  <p>SOP. TRANSMISIÓN AUT. FORD PROBE</p>	<p>6961</p>  <p>SOP. MOTOR FRONTAL MAZDA 323</p>	<p>6963</p>  <p>SOP. MOTOR TRASERO FORD PROBE</p>	<p>6964</p>  <p>SOP. TRANSMISIÓN STD. FORD PROBE</p>	<p>6966</p>  <p>SOP. MOTOR TRASERO STD. FORD PROBE, MAZDA 626</p>
<p>6967</p>  <p>SOP. MOTOR FRONTAL FORD PROBE, MAZDA 626</p>	<p>6969</p>  <p>SOP. MOTOR FRONTAL MAZDA 626</p>	<p>6970</p>  <p>SOP. MOTOR DERECHO NISSAN TSURU III, TSUBAME</p>	<p>6970-9</p>  <p>REP. SOP. MOT. DER. (6970) NISSAN TSURU III, TSUBAME</p>	<p>6971</p>  <p>SOP. MOTOR DERECHO BUICK LE SABRE JEEP WRANGLER</p>
<p>6973</p>  <p>SOP. MOTOR TRASERO FORD ESCORT</p>	<p>6974</p>  <p>SOP. MOTOR DERECHO CHEVROLET CAVALIER</p>	<p>6975</p>  <p>SOP. MOTOR DERECHO CHEVROLET CORSICA</p>	<p>6976-H</p>  <p>SOP. MOT. DERECHO AUDI A3, SEAT LEON, TOLEDO VW BEETLE, GOLF A4</p>	<p>6977</p>  <p>SOP. TRANSMISIÓN AUT. AUDI A3, SEAT LEON, TOLEDO VW BEETLE, GOLF A4</p>



<p>6978</p>  <p>SOP. MOTOR TRASERO AUDI A4, SEAT LEON VW GOLF, JETTA</p>	<p>6979</p>  <p>SOP. TRANSMISIÓN CHEVROLET CUTLASS MALIBU</p>	<p>6980-H</p>  <p>SOP. MOTOR DERECHO CHEVROLET MALIBU, ACHIEVA</p>	<p>6981</p>  <p>SOP. MOTOR DERECHI FORD ECONOLINE, E150</p>	<p>6982</p>  <p>SOP. MOTOR IZQUIERDO FORD ECONOLINE, E-150</p>
<p>6983</p>  <p>SOP. MOTOR DER. CHEVROLET CAMARO BLAZER, S10</p>	<p>6984</p>  <p>SOP. MOTOR FRONTAL AUT. FORD ESCORT</p>	<p>6985</p>  <p>REP. SOP. FRONTAL TRANS. CHEVROLET MALIBU PONTIAC GRAND AM</p>	<p>6986-KIT</p>  <p>BASE FRONTAL IZQ. Y DER. CHEVROLET MALIBU PONTIAC GRAND AM</p>	<p>6988-H</p>  <p>SOP. MOTOR DERECHO VW EUROVAN T-4</p>
<p>6989</p>  <p>SOP. TORSIÓN TRASERO FORD IKON, FIESTA, CURIER</p>	<p>6990</p>  <p>SOP. TRANSMISIÓN FORD IKON, FIESTA, CURIER</p>	<p>6990-9</p>  <p>REP. SOP. TRANS. (6990) FORD, IKON, FIESTA, CURIER</p>	<p>6991-H</p>  <p>SOP. MOTOR DERECHO FORD IKON, FIESTA</p>	<p>6992</p>  <p>BASE DEL. IZQ. Y DER. FORD MONDEO</p>
<p>6993</p>  <p>BASE TRASERA IZQ. Y DER. FORD MONDEO</p>	<p>6994</p>  <p>SOP. TRANSMISIÓN NISSAN URVAN</p>	<p>6995</p>  <p>SOP. MOTOR IZQ. Y DER. NISSAN URVAN</p>	<p>6996</p>  <p>SOP. MOTOR IZQUIERDO NISSAN URVAN</p>	<p>6997</p>  <p>REP. SOP. TRANSMISIÓN NISSAN, URVAN</p>
<p>6998</p>  <p>SOP. TRANSMISIÓN NISSAN PATHFINDER</p>	<p>6999</p>  <p>SOP. MOTOR TRASERO FORD KA</p>	<p>7000</p>  <p>SOPORTE TRANSMISIÓN FORD FOCUS</p>	<p>7001</p>  <p>SOP. TRANSMISIÓN FRONTAL FORD KA</p>	<p>7002</p>  <p>SOP. TRANSMISIÓN FORD KA</p>
<p>7003</p>  <p>SOP. MOTOR IZQUIERDO CHEVROLET S-10, BLAZER</p>	<p>7004</p>  <p>SOP. MOTOR DERECHO CHEVROLET S-10, BLAZER</p>	<p>7005-H</p>  <p>SOP. MOTOR DERECHO NISSAN PLATINA RENAULT CLIO, KANGOO</p>	<p>7005</p>  <p>SOP. MOTOR DERECHO NISSAN PLATINA RENAULT CLIO, KANGOO</p>	<p>7006</p>  <p>SOP. MOTOR TRASERO STD. NISSAN PLATINA RENAULT CLIO, KANGOO</p>

<p>7006-9</p>  <p>REP. SOP. MOTOR TRAS. STD. (7006) NISSAN PLATINA RENAULT CLIO, KANGOO</p>	<p>7007</p>  <p>SOP. MOTOR TRASERO AUT. NISSAN PLATINA RENAULT CLIO, KANGOO</p>	<p>7008</p>  <p>SOP. TRANSMISIÓN STD. NISSAN PLATINA RENAULT CLIO, KANGOO</p>	<p>7009</p>  <p>SOP. TRANSMISIÓN AUT. NISSAN PLATINA RENAULT CLIO, KANGOO</p>	<p>7010</p>  <p>SOP. MOTOR TRASERO NISSAN SENTRA</p>
<p>7011</p>  <p>SOP. MOTOR FRONTAL AUT. CHEVROLET ASTRA, ZAFIRA</p>	<p>7011-9</p>  <p>REP. SOP. FRONTAL T/AUT. (7011 Y 7022) CHEVROLET ASTRA, ZAFIRA</p>	<p>7012</p>  <p>SOP. TRANSMISIÓN CHRYSLER VOYAGER</p>	<p>7012-9</p>  <p>REP. MOTOR TRANSMISIÓN (6938 Y 7012) CHRYSLER VOYAGER GRAN VOYAGER</p>	<p>7013</p>  <p>SOP. MOTOR DERECHO FORD FIESTA, IKON</p>
<p>7014</p>  <p>SOP. TRANS. AUT. Y STD. CHEVROLET ASTRA, ZAFIRA</p>	<p>7015, 7015-KIT</p>  <p>BASE FRONTAL IZQ. Y DER. CHRYSLER VOYAGER</p>	<p>7016</p>  <p>SOP. MOTOR FRONTAL HYUNDAI ACCENT</p>	<p>7017-KIT</p>  <p>BASE FRONTAL IZQ. Y DER. NISSAN PLATINA RENAULT CLIO, KANGOO</p>	<p>7018</p>  <p>SOP. MOT. TRAS. AUT. CHRYSLER CIRRUS, STRATUS</p>
<p>7019-9</p>  <p>REP. SOP. FRONTAL Y TRAS. NISSAN ALTIMA</p>	<p>7020</p>  <p>SOP. MOTOR TRAS. IZQ. CHEVROLET ASTRA, ZAFIRA</p>	<p>7021</p>  <p>SOP. NITIR FRONTAL STD. CHEVROLET ASTRA, ZAFIRA</p>	<p>7022</p>  <p>SOP. MOTOR FRONTAL AUT. CHEVROLET ASTRA, ZAFIRA</p>	<p>7023</p>  <p>SOP. MOTOR DERECHO CHEVROLET ASTRA, ZAFIRA</p>
<p>7023-9</p>  <p>REP. SOP. MOTOR DER. (7023) CHEVROLET ASTRA, ZAFIRA</p>	<p>7024</p>  <p>SOP. TRANSMISIÓN HYUNDAI H100</p>	<p>7025</p>  <p>SOP. TRANSMISIÓN CHRYSLER INTREPID, LHS</p>	<p>7026-KIT</p>  <p>BASE FRONTAL IZQ. Y DER. NISSAN ALMERA, SENTRA RENAULT SCALA</p>	<p>7027</p>  <p>SOP. PARA PAL. DE VEL. NISSAN TSURU III</p>
<p>7028</p>  <p>SOP. TRANSMISIÓN AUT. CHRYSLER VOYAGER</p>	<p>7028-9</p>  <p>REP. SOP. TRANSMISIÓN (7028 Y 7054) CHRYSLER VOYAGER</p>	<p>7029, 7029-KIT</p>  <p>BASE IZQ. Y DER. FORD ESCORT</p>	<p>7030</p>  <p>SOP. MOTOR FRONTAL HYUNDAI VERNA</p>	<p>7031-9</p>  <p>REP. SOP. MOTOR IZQ. Y DER. (6883, 6897, 6881 Y 6882) JEEP GRAND CHEROKEE</p>



7032 SOP. TRANSMISIÓN NISSAN MAXIMA	7034 SOP. MOTOR TRASERO MEGANE SCENIC	7035 BASE FRONTAL IZQ. Y DER. AUDI A4, A5, A6, VW PASSAT	7036-H SOP. MOTOR DERECHO RENAULT MEGANE SCENIC	7037 SOP. TRANSMISIÓN AUT. RENAULT MEGANE SCENIC
7038 SOP. MOT. DERECHO NISSAN SENTRA RENAULT SCALA	7039 SOP. MOTOR DERECHO NISSAN URVAN	7040 SOP. TRANSMISIÓN AUT. NISSAN SENTRA	7041 SOP. MOTOR DERECHO (TROMPO CHICO AUT.) PEUGEOT PARTHER, 206, 207	7041-H SOP. MOTOR DERECHO (TROMPO CHICO AUT.) PEUGEOT PARTHER, 206, 207
7041-9 JUEGO LIMITADORES PARA SOP. 7041-H PEUGEOT 206, 207	7042 SOP. TRANSMISIÓN PEUGEOT 206, 207	7043 SOP. MOTOR FRONTAL AUT. ACURA EL, HONDA CIVIC	7044 SOP. DE TRANSMISIÓN AUT. ACURA EL, HONDA CIVIC	7045 BUJE P/BRAZO INF. TRAS. HONDA CIVIC
7046 SOP. MOTOR FRONTAL ACURA EL HONDA CIVIC	7047 SOP. MOTOR TRASERO HONDA CIVIC	7048-H SOP. MOTOR IZQUIERDO HONDA CIVIC	7049 REP. SOP. DE FLECHA TRAS. PEUGEOT 206, 306, PARTHER	7050 SOP. MOTOR DERECHO ACURA CL HONDA ACCORD, ODYSSEY
7051, 7051-KIT BASE FRONTAL IZQ. Y DER. CHRYSLER VOYAGER	7052 SOP. TRANSMISIÓN FRONTAL HONDA ACCORD, ODYSSEY	7053 SOP. TRANSMISIÓN TRASERO HONDA ACCORD, ODYSSEY	7054 SOP. TRANSMISIÓN AUT. CHRYSLER VOYAGER	7055-KIT BASE FRONTAL IZQ. Y DER. VW POINTER POINTER PICK UP
7056 SOP. TRASERO AUT. VW EUROVAN	7057-H SOP. MOTOR DER. VW LUPO, POLO	7058 SOP. MOTOR TRASERO VW LUPO, POLO	7059 SOP. MOTOR TRASERO VW EUROVAN	7059-9 REP. SOP. MOTOR TRASERO (7059) VW EUROVAN

<p>7060</p>  <p>SOP. TRANSMISIÓN STD. AUDI A1, SEAT IBIZA VW LUPO</p>	<p>7061</p>  <p>SOP. MOTOR TRAS. STD. VW EUROVAN</p>	<p>7062</p>  <p>SOP. MOTOR DERECHO VW EUROVAN</p>	<p>7063-H</p>  <p>SOP. MOTOR DERECHO (SOHC) FORD FOCUS</p>	<p>7063</p>  <p>SOP. MOTOR DERECHO (SOHC) FORD FOCUS</p>
<p>7064</p>  <p>SOP. MOTOR TRASERO FORD FOCUS</p>	<p>7065</p>  <p>SOP. TRANSMISIÓN AUT. NISSAN ALTIMA</p>	<p>7066</p>  <p>SOP. MOTOR DERECHO NISSAN ALTIMA</p>	<p>7067</p>  <p>SOP. MOTOR FRONTAL NISSAN SENTRA</p>	<p>7068</p>  <p>SOP. MOT. FRON. TURBO AUT. CHRYSLER STRATUS, CIRRUS</p>
<p>7069</p>  <p>SOP. TRANSMISIÓN STD. NISSAN ALTIMA, SENTRA</p>	<p>7069-9</p>  <p>REP. SOP. TRANSMISIÓN STD. (7069) NISSAN SENTRA</p>	<p>7070</p>  <p>BASE FRONTAL IZQ. Y DER. FORD FOCUS</p>	<p>7071-H</p>  <p>SOP. MOTOR DERECHO (DOHC) FORD FOCUS</p>	<p>7071</p>  <p>SOP. MOTOR DERECHO (DOHC) FORD FOCUS</p>
<p>7072-H</p>  <p>SOP. MOTOR DERECHO FORD FOCUS</p>	<p>7073-H</p>  <p>SOP. MOTOR DERECHO FORD FOCUS</p>	<p>7074</p>  <p>SOP. MOT. TRAS. STD., EASY TRONIC (COMP. 7075) CHEVROLET CORSA, MERIVA, TORNADO</p>	<p>7075</p>  <p>SOP. MOT. TRAS. STD. EASY TRONIC, (COMP. 7074) CHEVROLET CORSA, MERIVA, TORNADO</p>	<p>7076-H</p>  <p>SOP. TRANSMISIÓN STD., EASY TRONIC CHEVROLET CORSA, MERIVA, TORNADO</p>
<p>7077</p>  <p>SOP. MOTOR DER. STD. EASY TRONIC, CHEVROLET CORSA, MERIVA, TORNADO</p>	<p>7078</p>  <p>SOP. MOTOR FRONTAL STD. CHEVROLET ASTRA, ZAFIRA</p>	<p>7079</p>  <p>SOP. TRANSMISIÓN AUT. CHEVROLET BLAZER</p>	<p>7081</p>  <p>SOP. MOTOR DER. FORD FIESTA, KA</p>	<p>7082</p>  <p>SOP. TRANSMISIÓN FORD FIESTA, ECOSPORT</p>
<p>7083</p>  <p>SOP. MOTOR TRASERO FORD FIESTA, IKON</p>	<p>7086</p>  <p>SOP. MOTOR FRONTAL STD. EASY TRONIC CHEVROLET CORSA, MERIVA, TORNADO</p>	<p>7087</p>  <p>SOP. PARA PALANCA DE VELOCIDADES HYUNDAI ATOS</p>	<p>7088</p>  <p>SOP. TRANSMISIÓN CHEVROLET LUV</p>	<p>7089</p>  <p>SOP. MOTOR TRASERO HYUNDAI VERNA</p>



<p>7090</p>  <p>SOP. TRANSMISSION STD. HYUNDAI VERNA</p>	<p>7091</p>  <p>SOP. TRANSMISSION AUT. HYUNDAI VERNA</p>	<p>7092-H</p>  <p>SOP. MOTOR DERECHO VW EUROVAN</p>	<p>7093-H</p>  <p>SOP. MOTOR DERECHO VW EUROVAN</p>	<p>7094</p>  <p>SOP. MOTOR TRASERO HONDA ODYSSEY</p>
<p>7094-9</p>  <p>REP. SOPORTE MOT. TRAS. (7094) HONDA ODYSSEY</p>	<p>7095</p>  <p>SOP. MOTOR IZQ. Y DER. HYUNDAI H100</p>	<p>7096</p>  <p>SOP. TRANSMISSION FORD WINDSTAR</p>	<p>7097</p>  <p>REPUESTO SOP. IZQ. Y DER. (7003, 7004) CHEVROLET S-10, S-15</p>	<p>7098-H</p>  <p>SOP. MOTOR TRASERO VW EUROVAN</p>
<p>7099</p>  <p>SOP. MOTOR IZQ. Y DER. CHEVROLET LUV</p>	<p>7100</p>  <p>SOP. TRANSMISSION ACURA RSX, HONDA CR-V</p>	<p>7100-9</p>  <p>REP. SOP. DE TRANSMISSION (7100) ACURA RSX HONDA CR-V, ELEMENT</p>	<p>7101</p>  <p>SOP. MOTOR FRONTAL ACURA RSX HONDA CR-V</p>	<p>7102</p>  <p>SOP. MOTOR TRASERO ACURA RSX HONDA CR-V</p>
<p>7103</p>  <p>BASE FRONTAL IZQ. Y DER. VW POINTER</p>	<p>7104</p>  <p>SOP. MOTOR DERECHO NISSAN ALTIMA</p>	<p>7104-9</p>  <p>REP. SOP. MOTOR DERECHO (7104 Y 7247), NISSAN ALTIMA</p>	<p>7105</p>  <p>SOP. MOTOR IZQUIERDO FORD F-150, F-250, F-350</p>	<p>7106</p>  <p>SOP. MOTOR DERECHO FORD F-150, F-250, F-350</p>
<p>7107</p>  <p>SOP. MOTOR IZQUIERDO FORD EXPEDITION, F-250</p>	<p>7108</p>  <p>SOP. MOTOR DERECHO FORD F-150, F-250, F-350</p>	<p>7109</p>  <p>SOP. MOTOR IZQUIERDO AUT. FORD F-150, F-250, F-350</p>	<p>7110</p>  <p>SOP. MOTOR DERECHO FORD EXPEDITION, F-250</p>	<p>7111</p>  <p>SOP. MOTOR DERECHO FORD EXPEDITION, F-250</p>
<p>7112</p>  <p>SOP. MOTOR DERECHO FORD F-150, F-250, F-350</p>	<p>7113</p>  <p>SOP. MOTOR DERECHO FORD F-350</p>	<p>7114</p>  <p>SOP. MOTOR IZQUIERDO FORD F-350</p>	<p>7115</p>  <p>SOP. MOTOR DERECHO FORD F-350, ECONOLINE</p>	<p>7116</p>  <p>SOP. MOTOR IZQUIERDO FORD E-350, F-350, LOBO</p>

<p>7117</p>  <p>SOP. MOTOR TRASERO FORD ESCAPE</p>	<p>7118</p>  <p>SOP. TRANSMISSION FORD ESCAPE</p>	<p>7119</p>  <p>SOP. MOTOR FRONTAL CHRYSLER VOYAGER Y GRAND CARAVAN</p>	<p>7119-9</p>  <p>REP. SOP. MOT. FRONTAL (7119) CHRYSLER VOYAGER Y GRAND CARAVAN</p>	<p>7120</p>  <p>SOP. MOTOR IZQ. Y DER. CHEVROLET SILVERADO SIERRA</p>
<p>7121-H</p>  <p>SOP. MOTOR DERECHO CHRYSLER VOYAGER Y GRAN CARAVAN</p>	<p>7122</p>  <p>SOP. MOTOR TRASERO CHRYSLER VOYAGER Y GRAND CARAVAN</p>	<p>7123</p>  <p>SOP. MOTOR FRONTAL SUP. IZQ. Y DER. BUICK RENDEZVOUS CHEVROLET UPLANDER</p>	<p>7124</p>  <p>SOP. MOTOR DERECHO FORD ECONOLINE</p>	<p>7125</p>  <p>SOP. MOTOR IZQUIERDO FORD ECONOLINE</p>
<p>7126</p>  <p>SOPORTE MOTOR FRONTAL NISSAN XTRAIL</p>	<p>7127</p>  <p>SOP. MOTOR FRONTAL HYUNDAI ATOS</p>	<p>7128</p>  <p>SOP. MOT. IZQ. Y DER. CHEVROLET SILVERADO</p>	<p>7129</p>  <p>SOP. MOTOR DERECHO NISSAN X-TRAIL</p>	<p>7130</p>  <p>SOP. PARA TRANSMISION NISSAN X-TRAIL</p>
<p>7131</p>  <p>SOP. MOTOR IZQ. Y DER. TOYOTA HILUX</p>	<p>7132</p>  <p>SOPORTE TRANSMISION AUT. TOYOTA 4 RUNNER, HILUX</p>	<p>7133</p>  <p>SOP. MOTOR FRONTAL TOYOTA COROLLA, MATRIX</p>	<p>7134</p>  <p>SOPORTE MOTOR TRASERO TOYOTA COROLLA, MATRIX</p>	<p>7134-9</p>  <p>REP. SOP. MOT. TRAS. (7134) TOYOTA COROLLA, MATRIX</p>
<p>7135</p>  <p>SOPORTE TRANSMISION TOYOTA COROLLA, MATRIX</p>	<p>7136</p>  <p>SOP. MOTOR FRONTAL HONDA FIT</p>	<p>7137</p>  <p>SOP. TRANSMISION STD. HONDA FIT</p>	<p>7138</p>  <p>SOP. MOTOR TRASERO HONDA FIT</p>	<p>7139</p>  <p>SOP. MOTOR FRONTAL VW EUROVAN TDI</p>
<p>7140-H</p>  <p>SOP. MOTOR DERECHO HONDA FIT</p>	<p>7141</p>  <p>SOPORTE MOTOR FRONTAL NISSAN ALTIMA</p>	<p>7141-9</p>  <p>REP. SOP. MOTOR FRONTAL NISSAN ALTIMA</p>	<p>7142-H</p>  <p>SOP. MOTOR DERECHO TOYOTA COROLLA, MATRIX</p>	<p>7143</p>  <p>SOP. TRANSMISION VW EUROVAN TDI</p>



7144  GOMA SUJETADORA DE ESC. NISSAN PLATINA RENAULT CLIO	7145  SOP. MOTOR TRASERO VW EUROVAN TDI	7146  SOP. TRANSMISIÓN STD. CHEVROLET MATIZ	7147  BASE FRONTAL IZQ. Y DER. CHEVROLET MATIZ	7148  SOP. MOTOR TRASERO CHEVROLET MATIZ
7149  SOPORTE TRANSMISIÓN STD. CHEVROLET MATIZ	7150-H  SOP. TRANSMISIÓN STD. CHEVROLET OPTRA	7151-H  SOPORTE MOTOR DERECHO FORD FOCUS, MAZDA 3	7152  SOPORTE MOTOR TRASERO FORD FOCUS, MAZDA 3	7153  SOP. TRANSMISIÓN AUT. FORD FOCUS, MAZDA 3
7154  SOP. TRANSMISIÓN STD. FORD FOCUS, MAZDA 3	7155  SOP. TRANSMISIÓN STD. FORD FOCUS, MAZDA 3	7156  BASE TRASERA IZQ. Y DER. FORD FOCUS, MAZDA 3	7157-H  SOP. MOTOR DERECHO CHEVROLET OPTRA	7158  SOP. MOTOR DERECHO INF. CHEVROLET OPTRA
7159-H  SOP. MOTOR DERECHO PEUGEOT 206, 306, 405, 406	7160-9  REP. SOP. MOTOR FRONTAL Y TRAS. NISSAN ALTIMA, MAXIMA	7161  SOP. TRANSMISIÓN PEUGEOT 206, 306, 405, 406	7162-H  SOP. MOTOR DERECHO RENAULT MEGANE II SCENIC II	7163  SOP. MOTOR TRASERO RENAULT MEGANE II SCENIC II
7164  REP. SOP. DE FLECHA TRAS. PEUGEOT 206, 306, 405, 406	7165  SOPORTE TRANS. TRASERO HONDA ACCORD	7166  SOP. MOT. FRONTAL SUP. IZQ. Y DER. CHEVROLET CENTURY LUMINA, VENTURE	7167  SOPORTE TRANSMISIÓN MERCURY VILLAGER NISSAN QUEST	7168  SOPORTE MOTOR FRONTAL MERCURY VILLAGER NISSAN QUEST
7169  SOPORTE MOTOR TRASERO FORD VILLAGER NISSAN QUEST	7170  SOP. MOT. TRAS. DERECHO FORD VILLAGER NISSAN QUEST	7171  SOPORTE MOTOR FRONTAL FORD VILLAGER NISSAN QUEST	7172  SOP. DE TORSIÓN FRONTAL SUP. CHEVROLET CENTURY CUTLASS CIERA	7172-9  REP. SOP. DE TORSIÓN FRONT. (7172) CHEVROLET CENTURY CUTLASS CIERA

<p>7173</p>  <p>SOPORTE TRANSMISIÓN FORD F-100, F-150, F-250 F-350, SUPER DUTY</p>	<p>7174</p>  <p>SOPORTE TRANSMISIÓN CHRYSLER DURANGO, DAKOTA</p>	<p>7175</p>  <p>SOP. MOTOR IZQUIERDO CHRYSLER DURANGO, DAKOTA</p>	<p>7176</p>  <p>SOPORTE MOTOR DERECHO FORD EXPLORER MERCURY MONTAINEER</p>	<p>7177</p>  <p>SOP. MOTOR IZQUIERDO FORD EXPLORER MERCURY MONTAINEER</p>
<p>7178</p>  <p>SOPORTE TRANSMISIÓN 4X4 FORD EXPLORER MERCURY MONTAINEER</p>	<p>7180</p>  <p>SOPORTE MOTOR IZQUIERDO CHRYSLER RAM 1500, 2500, 3500</p>	<p>7180-9</p>  <p>REP. SOP. MOTOR IZQ. Y DER. (7180) CHRYSLER RAM 1500, RAM 2500</p>	<p>7181</p>  <p>SOPORTE MOTOR DERECHO CHRYSLER RAM 1500</p>	<p>7182</p>  <p>BASE FRONTAL IZQ. Y DER. FORD FOCUS, MAZDA 3</p>
<p>7183</p>  <p>SOP. MOTOR TRASERO DER. FORD, TAURUS, SABLE</p>	<p>7184</p>  <p>SOP. MOTOR IZQUIERDO FORD EXPLORER, RANGER</p>	<p>7185</p>  <p>SOPORTE TRANSMISIÓN FORD MONDEO</p>	<p>7186</p>  <p>SOPORTE MOTOR TRASERO FORD MONDEO</p>	<p>7187</p>  <p>SOPORTE TRANSMISIÓN STD. CHRYSLER NEON</p>
<p>7188</p>  <p>SOPORTE TRANSMISIÓN 4X4 JEEP LIBERTY</p>	<p>7189</p>  <p>SOPORTE TRANSMISIÓN AUT. JEEP LIBERTY</p>	<p>7190</p>  <p>SOPORTE TRANSMISIÓN STD. JEEP LIBERTY</p>	<p>7191</p>  <p>SOPORTE MOTOR DERECHO FORD WINDSTAR</p>	<p>7192</p>  <p>SOPORTE MOTOR DERECHO FORD WINDSTAR</p>
<p>7193</p>  <p>SOPORTE TRANSMISIÓN AUT. FRONTAL INF. HONDA ACCORD</p>	<p>7194</p>  <p>SOPORTE MOTOR TRAS. SUP. (CON CUERDA), VW BORA SEAT LEON Y TOLEDO</p>	<p>7195</p>  <p>SOPORTE MOTOR TRAS. INF. (SIN CUERDA), VW BORA SEAT LEON Y TOLEDO</p>	<p>7196</p>  <p>SOPORTE MOTOR TRASERO NISSAN TIIDA</p>	<p>7197</p>  <p>SOPORTE TRANSMISIÓN NISSAN TIIDA</p>
<p>7198-H</p>  <p>SOPORTE MOTOR DERECHO FORD MONDEO</p>	<p>7199-H</p>  <p>SOPORTE TRANSMISIÓN AUT. FORD WINDSTAR</p>	<p>7200</p>  <p>REP. SOP. TRANS. FRONTAL CHEVROLET CAVALIER PONTIAC SUNFIRE</p>	<p>7201</p>  <p>SOPORTE TRANSMISIÓN STD. TOYOTA YARIS</p>	<p>7201-9</p>  <p>REPUESTO SOPORTE TRANS. TOYOTA YARIS (7135 y 7201)</p>



7202  SOP. TRANSMISSION TRASERO HONDA ACCORD	7203  SOP. MOTOR DER. SUPERIOR NISSAN TIIDA	7204  SOP. MOTOR TRASERO STD. TOYOTA YARIS	7205-H  SOPORTE MOTOR DERECHO HONDA ACCORD	7206-H  SOP. MOTOR FRONTAL TRAS. HONDA ACCORD
7207-H  SOPORTE MOTOR TRASERO HONDA ACCORD	7208  SOPORTE MOTOR FRONTAL CHRYSLER CALIBER	7208-9  REPUESTO SOPORTE MOTOR FRONTAL (7208) CHRYSLER CALIBER	7209  SOP. MOTOR TRASERO STD. MITSUBISHI LANCER	7209-9  REPUESTO SOPORTE MOTOR TRASERO (7209) MITSUBISHI LANCER
7210  SOPORTE MOTOR DERECHO FORD ECO SPORT	7211  SOPORTE TRANSMISION SEAT LEON, TOLEDO VW BORA	7212  SOPORTE TRANSMISION SEAT LEON, TOLEDO VW BORA	7213  SOPORTE MOTOR IZQ. Y DER. MERCEDES BENZ SPRINTER	7214-KIT  BASE FRONTAL IZQ. Y DER. SEAT IBIZA VW LUPO, POLO
7215  SOPORTE MOTOR DERECHO FORD FIESTA	7216-9  REP. SOPORTE MOTOR FRONTAL Y TRASERO CHEVROLET MALIBU	7217-9  REP. SOP. MOTOR Y TRANS. NISSAN AL MERA, ALTIMA, MAXIMA, SENTRA, X-TRAIL	7218-H  SOPORTE MOTOR DERECHO NISSAN SENTRA	7219  SOPORTE MOTOR TRASERO NISSAN SENTRA
7220  SOPORTE MOTOR TRASERO CHEVROLET EQUINOX PONTIAC TORRENT	7221-KIT  BASE FRONTAL IZQ. Y DER. NISSAN MAXIMA, QUEST	7222-KIT  BASE FRONTAL IZQ. Y DER. BUICK ALLURE CHEVROLET GRAND PRIX PONTIAC AZTEK	7223  SOPORTE MOTOR TRASERO HONDA CIVIC	7224  SOPORTE TRANSMISION HONDA CIVIC
7225  SOPORTE MOTOR DERECHO FORD F-100, F-250, F-350	7226  SOPORTE MOTOR IZQUIERDO FORD F-100, F-250, F-350	7227  SOP. MOTOR TRASERO FORD TAURUS Y SABLE	7228  SOP. MOTOR IZQ. Y DER. JEEP WRANGLER	7229-KIT  BASE FRONTAL IZQ. Y DER. FORD WINDSTAR

<p>7230-KIT</p>  <p>BASE TRASERA IZQ. Y DER. CHRYSLER 300M, CONCORDE LHS, INTREPID</p>	<p>7231-KIT</p>  <p>BASE IZQUIERDA TOYOTA CAMRY, SIENNA</p>	<p>7232-KIT</p>  <p>BASE DERECHA TOYOTA CAMRY, SIENNA</p>	<p>7233</p>  <p>SOPORTE MOTOR TRASERO CHEVROLET HHR PONTIAC G5</p>	<p>7234</p>  <p>SOP. MOTOR FRONTAL PONTIAC G5 SOP. MOTOR FRONTAL AUT. CHEVROLET HHR</p>
<p>7235-H</p>  <p>SOPORTE MOTOR FRONTAL FORD FREESTAR MERCURY MONTERREY</p>	<p>7236-H</p>  <p>SOPORTE MOTOR TRASERO FORD FREESTAR MERCURY MONTERREY</p>	<p>7237-H</p>  <p>SOPORTE MOTOR DERECHO FORD ESCAPE, MAZDA TRIBUTE MERCURY MARINER</p>	<p>7238</p>  <p>SOPORTE MOTOR FRONTAL CHEVROLET EQUINOX PONTIAC TORRENT</p>	<p>7239-H</p>  <p>SOPORTE TRANSMISIÓN AUT. BUICK REGAL, CHEVROLET MONTE CARLO OLDSMOBILE CUTLASS</p>
<p>7240-H</p>  <p>SOPORTE MOTOR TRASERO FORD TAURUS MERCURY SABLE</p>	<p>7241</p>  <p>SOPORTE TRANSMISIÓN AUT. JEEP GRAND CHEROKEE</p>	<p>7243</p>  <p>SOPORTE TRANSMISIÓN STD. Y AUT. CHRYSLER DAKOTA</p>	<p>7244-H</p>  <p>SOPORTE MOTOR IZQ. Y DER. BUICK RAINIER CHEVROLET TRAILBLAZER OLDSMOBILE BRAVADA</p>	<p>7245</p>  <p>SOPORTE TRANSMISIÓN STD. HYUNDAI ATOS</p>
<p>7246</p>  <p>SOPORTE MOTOR TRASERO HYUNDAI ATOS</p>	<p>7247</p>  <p>SOPORTE MOTOR DERECHO NISSAN ALTIMA MAXIMA, MURANO, QUEST</p>	<p>7248</p>  <p>SOPORTE TRANSMISIÓN AUT. HONDA ACCORD</p>	<p>7249</p>  <p>SOPORTE MOTOR TRASERO FORD FUSION LINCOLN MKZ, ZEPHYR MAZDA 6, MERCURY MILAN</p>	<p>7250-H</p>  <p>SOPORTE MOTOR DERECHO FORD FUSION, LINCOLN MKZ MAZDA 6, MERCURY MILAN</p>
<p>7253</p>  <p>SOP. FRONTAL DERECHO CHRYSLER DAKOTA, DURANGO</p>	<p>7254</p>  <p>SOPORTE MOTOR TRASERO SEAT LEON Y TOLEDO VW BORA Y PASSAT</p>	<p>7255-H</p>  <p>SOPORTE MOTOR DERECHO FORD FUSION, MERCURY MILAN LINCOLN ZEPHYR, MKZ</p>	<p>7256-H</p>  <p>SOPORTE MOTOR FRONTAL TOYOTA CAMRY, SIENA</p>	<p>7257-H</p>  <p>SOPORTE MOTOR DERECHO TOYOTA CAMRY, HIGHLANDER SIENNA Y SOLARA</p>
<p>7258</p>  <p>SOPORTE TRANSMISIÓN STD. Y AUT. CHEVROLET AVEO, PONTIAC G3</p>	<p>7258-9 <small>NUEVO</small></p>  <p>REP. SOP. TRANS. STD. Y AUT. (7258) HEVROLET AVEO PONTIAC G3, WAVE</p>	<p>7259</p>  <p>SOPORTE MOTOR DERECHO CHEVROLET AVEO, PONTIAC G3</p>	<p>7259-9 <small>NUEVO</small></p>  <p>REP. SOP. MOTOR DER. (7259) CHEVROLET AVEO PONTIAC G3, WAVE</p>	<p>7260</p>  <p>SOPORTE MOTOR TRASERO CHEVROLET AVEO PONTIAC G3</p>



7260-9   REP. SOP. MOT. TRAS. (7260) CHEVROLET AVEO PONTIAC G3, WAVE	7261  SOPORTE MOTOR FRONTAL CHEVROLET TRACKER SUZUKI SIDEKICK	7262  SOPORTE TRANSMISION STD. CHEVROLET TRACKER SUZUKI VITARA	7263  SOPORTE MOTOR FRONTAL TOYOTA RAV4	7264  SOP. MOTOR FRONTAL DER. TOYOTA CAMRY, SOLARA
7265  SOPORTE MOTOR DERECHO NISSAN MAXIMA INFINITI I30, I35	7266-EL  SOPORTE MOTOR FRONTAL NISSAN ALTIMA, MAXIMA MURANO Y QUEST	7267   SOPORTE MOTOR TRASERO NISSAN ALTIMA, MAXIMA MURANO, QUEST	7267-EL  SOPORTE MOTOR TRASERO NISSAN ALTIMA, MAXIMA MURANO Y QUEST	7268  SOPORTE MOTOR FRONTAL SUPERIOR AUT. HONDA CIVIC
7269  SOPORTE TRANSMISION CHEVROLET TRACKER SUZUKI VITARA	7272  SOPORTE MOTOR DERECHO CHRYSLER GRAND CHEROKE	7273  SOPORTE MOTOR FRONTAL SUZUKI AERIO	7274  SOPORTE TRANSMISION 4X4 NISSAN ARMADA INFINITI, NISSAN	7275  SOPORTE MOTOR IZQ. Y DER. NISSAN ARMADA, TITAN
7276-H  SOPORTE TRANSMISION FORD FUSION LINCOLN MKZ, ZEPHYR MAZDA 6, MERCURY MILAN	7277-H  SOPORTE MOTOR FRONTAL CHRYSLER PACIFICA	7278-H  SOPORTE MOTOR DERECHO (MOTOR ECOTEC) CHEVROLET CAVALIER PONTIAC SUNFIERE	7279  SOPORTE MOTOR FRONTAL CHRYSLER AVENGER, CIRRUS JOURNEY, SEBRING	7279-9   REP. SOP. MOT. FRONT. TRAS. (7279) CHRYSLER 200 AVENGER, CIRRUS, JOURNEY
7280  SOPORTE MOTOR TRASERO CHEVROLET MATIZ, SPARK	7281  SOPORTE MOTOR FRONTAL FORD ESCAPE MERCURY MARINER	7282  SOPORTE MOTOR TRASERO FORD ESCAPE MERCURY MARINER	7283  SOPORTE TRANSMISION PONTIAC G3 SUZUKI AERIO	7284-KIT  BASE TRASERA IZQ. Y DER. CHEVROLET AVEO PONTIAC G3
7285-KIT  BASE TRASERA IZQ. CHEVROLET GRAND PRIX BASE TRASERA DER. CHEVROLET MONTE CARLO	7286-KIT  BASE FRONTAL IZQ. Y DER. FORD SABLE, TAURUS	7287-KIT  BASE TRASERA IZQ. Y DER. BMW X5	7288-KIT  BASE TRASERA IZQ. Y DER. TOYOTA 4RUNNER	7289-KIT  BASE FRONTAL IZQ. Y DER. CHEVROLET TRACKER

<p>7290-KIT</p> <p>BASE FRONTAL IZQ. Y DER. CHEVROLET TRACKER</p>	<p>7291-KIT</p> <p>BASE TRASERA IZQ. Y DER. INFINITI I30 NISSAN ALTIMA, MAXIMA</p>	<p>7292-KIT</p> <p>BASE FRONTAL IZQ. Y DER. TOYOTA RAV-4</p>	<p>7293-KIT</p> <p>BASE TRASERA IZQ. Y DER. CHRYSLER NEON</p>	<p>7294-KIT</p> <p>BASE FRONTAL IZQ. Y DER. CHEVROLET AVEO PONTIAC G3</p>
<p>7295-KIT</p> <p>BASE P FRONTAL IZQ. Y DER. CHEVROLET TRACKER SUZUKI SIDEKICK</p>	<p>7296-KIT</p> <p>BASE TRASERA DER. CHEVROLET GRAND PRIX BASE TRASERA IZQ. CHEVROLET GRAND PRIX</p>	<p>7297-KIT</p> <p>BASE TRASERA IZQ. Y DER. NISSAN MAXIMA BASE TRASERA DER. NISSAN STANZA, MAXIMA</p>	<p>7298-KIT</p> <p>BASE FRONTAL IZQ. Y DER. INFINITI I30, I35 NISSAN MAXIMA</p>	<p>7299-KIT</p> <p>BASE FRONTAL IZQ. Y DER. FORD ESCAPE MAZDA TRIBUTE MERCURY MARINER</p>
<p>7300-KIT</p> <p>BASE FRONTAL IZQ. Y DER. INFINITI I30, I35 NISSAN ALTIMA, MAXIMA MURANO, QUEST, XTRAIL</p>	<p>7301</p> <p>BASE TRASERA IZQ. Y DER. VW DERBY, GOLF A2 Y A2 JETTA A2 Y A3</p>	<p>7303</p> <p>SOPORTE MOTOR DERECHO FORD CROWN VICTORIA MERCURY GRAND MARQUIS MARAUDER</p>	<p>7305</p> <p>SOPORTE MOTOR FRONTAL CHEVROLET VECTRA</p>	<p>7306</p> <p>SOPORTE MOTOR IZQ. Y DER. CHEVROLET TRACKER SUZUKI GRAND VITARA VITARA XL-7</p>
<p>7307</p> <p>SOPORTE MOTOR TRASERO TOYOTA RAV-4</p>	<p>7308</p> <p>SOPORTE MOTOR FRONTAL MITSUBISHI LANCER</p>	<p>7308-9</p> <p>REP. SOP. MOTOR FRONTAL MITSUBISHI LANCER</p>	<p>7309</p> <p>SOPORTE TRANSMISIÓN TOYOTA HIACE</p>	<p>7310</p> <p>SOPORTE MOTOR TRASERO CHRYSLER AVENGER, CIRRUS SEBRING, JOURNEY</p>
<p>7311</p> <p>SOPORTE TRANSMISIÓN AUT. BUICK RAINIER CHEVROLET TRAILBLAZER ISUZU ASCENDER, SAAB 97X OLDSMOBILE BRAVADA</p>	<p>7312</p> <p>REP. SOP. TRANSMISIÓN TRASERO STD., CHEVROLET CAVALIER PONTIAC SUNFIRE</p>	<p>7313</p> <p>SOPORTE MOTOR TRASERO CHEVROLET VECTRA, CRUZE</p>	<p>7314</p> <p>SOPORTE MOTOR DERECHO MITSUBISHI LANCER</p>	<p>7315</p> <p>SOPORTE MOTOR TRASERO SUZUKI AERIO</p>
<p>7316</p> <p>SOPORTE MOTOR DERECHO SUZUKI AERIO</p>	<p>7317</p> <p>BASE FRONTAL IZQ. Y DER. CHEVROLET VECTRA</p>	<p>7318-KIT</p> <p>BASE TRASERA IZQ. Y DER. NISSAN ALMERA, SENTRA, ESCALA</p>	<p>7319-KIT</p> <p>BASE FRONTAL IZQ. Y DER. CHRYSLER CIRRUS (COUPE) SEBRING (COUPE)</p>	<p>7320-KIT</p> <p>BASE FRONTAL IZQ. Y DER. TOYOTA COROLLA, MATRIX</p>



7321 SOPORTE MOTOR FRONTAL CHRYSLER JOURNEY	7321-9 REP. SOP. MOTOR FRONTAL (7321 Y 7330) CHRYSLER JOURNEY	7322 SOPORTE TRANSMISION NISSAN SENTRA	7323-H SOPORTE MOTOR DERECHO HONDA CIVIC	7324 SOPORTE TRANSMISIÓN NISSAN ARMADA SOPORTE TRANSMISIÓN 4X4 NISSAN TITAN
7325-KIT BASE TRASERA DERECHA TOYOTA COROLLA, MATRIX	7326 SOPORTE MOTOR IZQ. Y DER. TOYOTA HIACE	7327-KIT BASE FRONTAL IZQ. Y DER. TOYOTA CAMRY, SIEENA	7328-KIT BASE TRASERA IZQ. Y DER. CHEVROLET MALIBU PONTIAC GRAND AM	7329-H SOPORTE MOTOR DERECHO CHRYSLER AVENGER CIRRUS
7330 SOPORTE MOTOR TRASERO CHRYSLER JOURNEY	7331 SOPORTE DE TORSIÓN SUPERIOR DER. RENAULT MEGANE II, SCENIC	7332 BASE FRONTAL IZQ. Y DER. CHRYSLERE CALIBER JEEP PATRIOT COMPASS	7333 BASE FRONTAL IZQ. Y DER. CHEVROLET OPTRA	7334-H SOPORTE MOTOR DERECHO CHEVROLET VECTRA
7335-H SOPORTE TRANSMISIÓN CHEVROLET VECTRA	7336-H SOPORTE MOTOR IZQ. Y DER. MERCEDES BENZ 190 D, 190 E, 300 CE, 300 E	7337 SOPORTE TRANSMISIÓN CHRYSLER AVENGER JOURNEY	7337-9 REP. SOP. TRANSMISIÓN 7337 CHRYSLER SEBRING TOWN & CONTRY, VOYAGER VW ROUTAN	7338 GOMA SUJETADORA DE ESCAPE, RENAULT CLIO KANGOO, NISSAN PLATINA
7339-H SOPORTE MOTOR DERECHO FORD ESCAPE MERCURY MARINER	7340 SOPORTE TRANSMISIÓN FORD ESCAPE MERCURY MARINER	7341-KIT BASE FRONTAL IZQ. Y DER. CHRYSLER 300 M CONCORDE	7342 BASE FRONTAL DERECHA FIAT ADVENTURE, PALIO	7343 SOPORTE MOTOR FRONTAL CHRYSLER ATTITUDE
7344 BASE FRONTAL IZQ. Y DER. CHRYSLER ATTITUDE KIA RIO	7345-H SOPORTE MOTOR DERECHO CHRYSLER JOURNEY	7346 SOPORTE MOTOR TRASERO CHRYSLER ATTITUDE	7347-H SOPORTE MOTOR DERECHO RENAULT TRAFIC	7348 SOPORTE MOTOR DERECHO CHRYSLER CALIBER JEEP COMPASS LANCER MITSUBISHI

<p>7348-9</p>  <p>REP. SOP. MOTOR DERECHO CALIBER, COMPASS PATRIOT, LANCER</p>	<p>7349</p>  <p>SOPORTE MOTOR TRASERO HONDA ACCORD</p>	<p>7350-KIT</p>  <p>BASE FRONTAL DERECHA HONDA CIVIC, CR-V, ELEMENT</p>	<p>7351-KIT</p>  <p>BASE FRONTAL IZQUIERDA HONDA CIVIC, CR-V, ELEMENT</p>	<p>7352-KIT</p>  <p>BASE TRASERA IZQ. Y DER. NISSAN ALTIMA</p>
<p>7353</p>  <p>BASE TRASERA IZQ. Y DER. FORD ECO SPORT, FIESTA</p>	<p>7354</p>  <p>SOPORTE MOTOR IZQ. Y DER. NISSAN D-22, FRONTIER</p>	<p>7355-KIT</p>  <p>BASE FRONTAL IZQ. Y DER. HONDA ODYSSEY</p>	<p>7356-KIT</p>  <p>BASE FRONTAL IZQ. Y DER. CHEVROLET CADILLAC</p>	<p>7357</p>  <p>BASE FRONTAL DERECHA NISSAN TIDA, VERSA</p>
<p>7358</p>  <p>SOPORTE TRANSMISIÓN CHRYSLER CALIBER JEEP COMPASS</p>	<p>7359</p>  <p>SOPORTE MOTOR TRASERO CHRYSLER CALIBER JEEP COMPASS</p>	<p>7360</p>  <p>SOPORTE TRANSMISIÓN MITSUBISHI LANCER</p>	<p>7361</p>  <p>SOPORTE TRANSMISIÓN AUT. CHRYSLER NEON</p>	<p>7362</p>  <p>SOPORTE MOTOR FRONTAL SUPERIOR IZQ. Y DER. BUICK, CHEVROLET, PONTIAC</p>
<p>7363</p>  <p>SOPORTE TRANSMISIÓN CHRYSLER PACIFICA</p>	<p>7364-H</p>  <p>SOPORTE MOTOR FRONTAL ACURA MDX, HONDA PILOT</p>	<p>7365-H</p>  <p>SOPORTE MOTOR IZQ. Y DER. CHEVROLET CHEYENNE CADILLAC ESCALADE</p>	<p>7366-KIT</p>  <p>BASE FRONTAL IZQ. Y DER. FORD D -150, F-150 LINCOLN MARK LT</p>	<p>7367-KIT</p>  <p>BASE FRONTAL IZQ. Y DER. FORD EXPEDITION</p>
<p>7368-KIT</p>  <p>BASE TRASERA IZQ. Y DER. FORD EXPEDITION</p>	<p>7369-KIT</p>  <p>BASE FRONTAL IZQ. Y DER. JEEP COMMANDER</p>	<p>7370-KIT</p>  <p>BASE FRONTAL IZQUIERDA JEEP LIBERTY, NITRO</p>	<p>7371-KIT</p>  <p>BASE FRONTAL DERECHA JEEP LIBERTY, NITRO</p>	<p>7372-KIT</p>  <p>BASE FRONTAL IZQ. Y DER. FORD FREESTAR</p>
<p>7373-KIT</p>  <p>BASE FRONTAL IZQ. Y DER. HONDA PILOT</p>	<p>7374-KIT</p>  <p>BASE TRASERA IZQ. Y DER. TOYOTA CAMRY</p>	<p>7375-KIT</p>  <p>BASE FRONTAL DERECHA PEUGEOT 206</p>	<p>7376-KIT</p>  <p>BASE FRONTAL IZQUIERDA PEUGEOT 206</p>	<p>7377-KIT</p>  <p>BASE FRONTAL IZQ. Y DER. CHEVROLET TRAIL BLAZER OLDSMOBILE BRAVADA</p>



7378-KIT  BASE FRONTAL IZQ. Y DER. TOYOTA HIGHLANDER	7379-H  SOPORTE MOTOR DERECHO CHEVROLET OLDSMOBILE	7380  SOPORTE TRANSMISIÓN VW GOL. SAVEIRO	7381-KIT  BASE FRONTAL IZQ. Y DER. CHRYSLER NEON, PT CRUISER	7382-H  SOPORTE MOTOR IZQUIERDO FORD F-100, F250, 350, LOBO LINCOLN MARK LT
7383-H  SOPORTE MOTOR DERECHO FORD F-100, F250, 350, LOBO LINCOLN MARK LT	7384-KIT  BASE FRONTAL IZQ. Y DER. FORD ECO SPORT, FIESTA	7385  BASE FRONTAL IZQ. Y DER. CHEVROLET CRUZE	7386  BASE TRASERA IZQ. Y DER. CHEVROLET CRUZE	7387  SOPORTE TRANSMISIÓN STD. CHEVROLET CRUZE
7388  SOPORTE TRANSMISIÓN AUT. CHEVROLET CRUZE	7389  SOPORTE MOTOR DERECHO HONDA ODYSSEY	7390  SOPORTE TRANSMISIÓN AUT. NISSAN SENTRA	7391  SOPORTE MOTOR IZQ. Y DER. CHEVROLET C-3500 SIERRA 1500, SILVERADO 1500	7392  SOPORTE MOTOR IZQ. Y DER. CHEVROLET CHEYENNE DENALI, SIERRA 1500
7393  SOPORTE MOTOR DERECHO VW GOL. SAVEIRO	7394  BASE FRONTAL IZQUIERDA NISSAN TIIDA, VERSA	7394-KIT  BASE FRONTAL IZQUIERDA NISSAN TIIDA, VERSA	7395  SOPORTE TRANS. AUT. NISSAN ALTIMA, MAXIMA MURANO, QUEST	7396  SOPORTE TRANSMISIÓN FRONTAL INFERIOR HONDA ACCORD
7397-H  SOPORTE MOTOR FRONTAL HONDA ACCORD	7398-H  SOPORTE TRANSMISIÓN HONDA ACCORD	7398-H-9  SOP. TRANSMISIÓN HONDA ACCORD, CROSSTOUR	7399-H  SOPORTE MOTOR DERECHO NISSAN TIIDA	7400  SOPORTE MOTOR FRONTAL CHEVROLET MALIBU PONTIAC G6
7401  SOPORTE MOTOR IZQ. Y DER. CHEVROLET CHEYENNE	7402-H  SOPORTE MOTOR DERECHO CHEVROLET CRUZE	7403  SOP. MOTOR FRONTAL AUT. CHEVROLET CRUZE	7404  SOPORTE MOTOR TRASERO NISSAN X-TRAIL	7405  SOPORTE MOTOR TRASERO NISSAN ROGUE RENAULT KOLEOS

<p>7406</p>  <p>SOPORTE TRANSMISIÓN NISSAN MARCH, VERSA</p>	<p>7407</p>  <p>SOPORTE MOTOR TRASERO NISSAN MARCH, VERSA</p>	<p>7408-KIT</p>  <p>BASE FRONTAL IZQ. Y DER. NISSAN MARCH, VERSA</p>	<p>7409</p>  <p>SOP. MOT. DER. SUP. (TORSION) NISSAN ROGUE RENAULT KOLEOS</p>	<p>7410-KIT</p>  <p>BASE FRONTAL IZQ. NISSAN SENTRA, X-TRAIL RENAULT KOLEOS</p>
<p>7411-KIT</p>  <p>BASE FRONTAL DER. NISSAN SENTRA, X-TRAIL RENAULT KOLEOS</p>	<p>7412</p>  <p>SOP. MOTOR DERECHO SUPERIOR STD. HONDA CIVIC</p>	<p>7413</p>  <p>SOPORTE MOT. TRAS. STD. HONDA CIVIC</p>	<p>7414</p>  <p>SOP. MOTOR TRASERO CHRYSLER CALIBER JEEP COMPASS, MITSUBISHI</p>	<p>7414-9</p>  <p>REP. SOP. MOTOR TRAS. AUT. (7014) CHRYSLER CALIBER JEEP COMPASS, PATRIOT</p>
<p>7415-9</p>  <p>REP. SOP. MOTOR TRAS. AUT. MITSUBISHI ECLIPSE GALANT, ENDEAVOR</p>	<p>7416</p>  <p>SOP. MOTOR FRONTAL MITSUBISHI ECLIPSE GALANT, ENDEAVOR</p>	<p>7416-9</p>  <p>REP. SOP. MOTOR FRONTAL MITSUBISHI ECLIPSE GALANT, ENDEAVOR</p>	<p>7417-9</p>  <p>REP. SOP. MOTOR DER. CHRYSLER STRATUS MITSUBISHI ECLIPSE, GALANT</p>	<p>7418-9</p>  <p>REP. SOP. TRANSMISIÓN GALANT, ECLIPSE</p>
<p>7419</p>  <p>SOPORTE MOT. TRAS. AUT. TOYOTA YARIS</p>	<p>7420</p>  <p>SOPORTE TRANSMISIÓN IZQ. Y DER. NISSAN D22</p>	<p>7421</p>  <p>SOPORTE TRANSMISIÓN NISSAN X-TERRA FRONTIER</p>	<p>7422</p>  <p>SOPORTE MOT. FRONT. AUT. MITSUBISHI, ECLIPSE, GALANT</p>	<p>7423</p>  <p>SOP. TRANSMISIÓN MITSUBISHI ECLIPSE GALANT, TALON</p>
<p>7424</p>  <p>SOP. FLECHA CARDAN CHEVROLET COLORADO GMC CANYON</p>	<p>7425</p>  <p>SOP. TRANSMISIÓN AUT. HONDA FIT</p>	<p>7425-9</p>  <p>REP. SOP. TRANSMISIÓN (7137 Y 7425) HONDA FIT</p>	<p>7426</p>  <p>SOP. TRANSMISIÓN AUT. CHRYSLER TOWN & COUNTRY GRAND CARAVAN, VW ROUTAN</p>	<p>7427-KIT</p>  <p>BASE FRONTAL IZQ. Y DER. HYUNDAI I10</p>
<p>7428-9</p>  <p>REP. SOPORTE DE TORSIÓN TOYOTA SIENNA</p>	<p>7429</p>  <p>SOPORTE MOTOR DER. INF. CHEVROLET OPTRA</p>	<p>7430-9</p>  <p>REP. SOPORTE MOTOR TRASERO 4X4 NISSAN X-TRAIL</p>	<p>7431-H</p>  <p>SOPORTE MOTOR DER. PEUGEOT 407, 605</p>	<p>7432</p>  <p>SOPORTE MOTOR IZQ. Y DER. CHEVROLET TRACKER SUZUKI SIDEKICK</p>



7433  SOPORTE MOTOR TRAS. TOYOTA YARIS, ECHO	7434  SOPORTE MOTOR TRAS. STD. RENAULT MEGANE I, SCENIC	7435  SOPORTE MOTOR DER. TOYOTA YARIS, ECHO	7436  SOPORTE MOTOR TRAS. MAZDA 6	7437  SOPORTE MOTOR TRAS. HYUNDAI ATTITUDE
7438  SOPORTE MOTOR TRAS. SUP. VOLVO S60, V70, S80, XC 70	7439  SOPORTE TRANSMISIÓN HYUNDAI i10	7440-9  REP. SOPORTE DE TORSIÓN CAMRY, SIENNA	7441  SOPORTE TRANSMISIÓN NISSAN SENTRA	7442-H  SOPORTE MOTOR IZQ. Y DER. CHRYSLER CHARGER MAGNUM
7443-KIT  BASE FRONTAL IZQ. Y DER. NISSAN APRIO RENAULT SANDERO, STEPWAY	7444  SOPORTE MOTOR DER. NISSAN APRIO	7445  SOPORTE TRANSMISIÓN NISSAN APRIO, MICRA RENAULT SANDERO, STEPWAY	7446  SOPORTE TRANSMISIÓN SUP. VW EUROVAN	7447  SOP. TRANSMISIÓN NISSAN URVAN (GASOLINA)
7448-H  SOPORTE MOTOR DER. CHEVROLET UPLANDER VENTURE, PONTIAC AZTEC	7449  BUJE P/CHASIS O BASTIDOR VW EUROVAN, TRANSPORTER	7450  SOPORTE MOT. FRONT. SUP. RENAULT CLIO, KANGOO	7451  SOPORTE MOT. FRONT. STD. CHEVROLET CRUZE	7452-H  SOPORTE MOTOR IZQ. Y DER. AUDI A4, A6, VW PASSAT
7453-H  SOPORTE MOTOR DERECHO AUDI Q3, VW TIGUAN	7454  SOPORTE MOTOR TRAS. MERCEDES BENZ A-140, A-160 A-190, A-210	7455  SOPORTE MOTOR IZQ. Y DER. MERCEDES BENZ, ML-320 ML-350, ML-430, ML-500	7456-H  SOPORTE MOTOR DERECHO TOYOTA-RAV-4	7457  SOPORTE MOTOR FRONTAL TOYOTA-RAV-4
7458  SOPORTE TORSIÓN SUP. DER. NISSAN ALTIMA	7459  SOPORTE TRANSMISIÓN AUT. JEEP LIBERTY	7460  SOPORTE MOTOR TRASERO FORD FOCUS	7461-H  SOPORTE MOTOR DER. FORD IKON	7462  SOPORTE MOTOR DERECHO FORD MUSTANG

<p>7463</p> <p>SOPORTE TRANS. AUT. Y STD. CHRYSLER DURANGO RAM-1500, RAM-2500</p>	<p>7464</p> <p>SOPORTE MOTOR TRASERO RENAULT LAGUNA</p>	<p>7465</p> <p>BASE FRONTAL IZQ. Y DER. MERCEDES BENZ CLASE C</p>	<p>7466</p> <p>SOPORTE TRANS. STD. Y AUT. CHRYSLER CROSSFIRE MERCEDES BENZ C-230</p>	<p>7467-H</p> <p>SOPORTE MOTOR DER. VW EUROVAN, TRANSPORTER</p>
<p>7468-H</p> <p>SOPORTE MOTOR IZQ. Y DER. BMW Z4 II, 323I, 325I, 328I 328 XI, 335I, 335 XI</p>	<p>7469-H</p> <p>SOPORTE TRANSMISIÓN CHEVROLET CAMARO PONTIAC FIREBIRD</p>	<p>7470-H</p> <p>SOPORTE TRANSMISIÓN AUT. 4 VEL. CHEVROLET ASTRO</p>	<p>7471-H</p> <p>SOPORTE MOTOR DER. STD. CHEVROLET HHR, PONTIAC G5</p>	<p>7472-H</p> <p>SOPORTE MOTOR DER. AUT. CHEVROLET HHR, PONTIAC G5</p>
<p>7473-H</p> <p>SOPORTE MOTOR DER. CHEVROLET EQUINOX PONTIAC TORRENT</p>	<p>7474</p> <p>SOPORTE TRANSMISIÓN CHEVROLET EXPRESS</p>	<p>7475</p> <p>SOPORTE MOTOR TRAS. BUICK LACROSSE CHEVROLET IMPALA</p>	<p>7477</p> <p>SOPORTE MOTOR FRONTAL NISSAN MAXIMA INFINITI I30</p>	<p>7478</p> <p>SOPORTE MOTOR FRONTAL TRANSMISIÓN STD. CHEVROLET VECTRA</p>
<p>7478-9</p> <p>REP. SOP. MOT. FRONTAL Y TRASERO (7305, 7313 Y 7478) CHEVROLET VECTRA</p>	<p>7479</p> <p>SOPORTE MOTOR IZQ. Y DER. TOYOTA TACOMA, 4 RUNNER</p>	<p>7480</p> <p>SOP. PARA DIFERENCIAL AUT. Y 4X4, HONDA CR-V</p>	<p>7481</p> <p>SOPORTE MOTOR TRAS. STD. FORD ECOSPORT</p>	<p>7482</p> <p>SOPORTE TRANS. REP. 6985 CHEVROLET MALIBU, CUTLASS, GRAND AM</p>
<p>7483-H</p> <p>SOPORTE MOTOR FRONTAL CHEVROLET IMPALA LACROSSE</p>	<p>7484</p> <p>SOPORTE MOTOR FRONTAL SUP. IZQ. Y DER. CHEVROLET IMPALA</p>	<p>7485</p> <p>SOPORTE MOTOR DERECHO HYUNDAI I10</p>	<p>7486-H</p> <p>SOPORTE MOTOR DERECHO HYUNDAI ATTITUDE</p>	<p>7487-H</p> <p>SOPORTE MOTOR DERECHO HYUNDAI SONATA, AZERA</p>
<p>7488</p> <p>SOPORTE TRANSMISIÓN HYUNDAI ATTITUDE</p>	<p>7489</p> <p>SOPORTE TRANSMISIÓN STD. HYUNDAI SONATA</p>	<p>7490</p> <p>SOPORTE MOTOR FRONTAL HYUNDAI SONATA, AZERA KIA AMANTI</p>	<p>7491-H</p> <p>SOPORTE MOTOR DERECHO FORD FIESTA</p>	<p>7492</p> <p>SOPORTE TRANSMISIÓN FORD FIESTA</p>



7493 SOPORTE MOTOR TRASERO NISSAN SENTRA	7494 SOPORTE MOTOR DER. NISSAN D-22 (NP-300) (DIESEL)	7495 SOPORTE MOTOR TRASERO FORD FIESTA	7496-H SOPORTE TRANS. STD. CHEVROLET SONIC	7497-H SOPORTE TRANS. AUT. CHEVROLET SONIC
7498 SOPORTE MOTOR DER. CHEVROLET SONIC	7499 SOPORTE MOTOR TRAS. CHEVROLET SONIC	7500 SOPORTE TRANSMISIÓN TOYOTA RAV-4	7501-H SOPORTE MOTOR DER. ACCORD, TSX, TL	7502 SOPORTE MOTOR FRONTAL HONDA ACCORD
7503-H SOPORTE MOTOR TRAS. ACURA TL, CL HONDA ACCORD	7504 REP. SOPORTE MOT. TRAS. MAZDA CX-7, CX-9	7505-KIT BASE FRONTAL IZQ. Y DER. RENAULT LAGUNA	7506-KIT BASE FRONTAL IZQ. Y DER. RENAULT TRAFIC	7507-KIT BASE FRONTAL IZQ. Y DER. RENAULT MEGANE II Y SCENIC II
7508 SOPORTE TRANSMISIÓN ACURA TL, HONDA ACCORD	7509-H SOPORTE MOTOR FRONTAL CHRYSLER PACIFICA	7510-H SOPORTE MOTOR DERECHO CHEVROLET MALIBU PONTIAC G6	7511-H SOPORTE MOTOR IZQ. Y DER. MERCEDES BENZ C-230, C-250 C-280, C-350, E-250, E-300	7512 SOP. MOTOR FRONTAL MERCEDES BENZ A-140 A-160, A-190, A-210
7513 SOPORTE TRANSMISIÓN CHEVROLET CAMARO PONTIAC FIREBIRD	7514 SOP. TRANSMISIÓN DIESEL NISSAN URVAN	7515 SOPORTE TRANSMISIÓN AUT. CHEVROLET CAMARO	7516-H SOPORTE TRANS. (CVT) NISSAN ALTIMA	7517-H SOPORTE MOTOR DER. NISSAN ALTIMA
7518-EL SOPORTE MOTOR TRASERO HONDA ACCORD, CROSS TOUR	7519-EL SOPORTE MOTOR FRONTAL ACURA RDX HONDA ACCORD, ODYSSEY	7520 SOP. MOTOR TRAS. AUT. CHEVROLET HHR, PONTIAC G5	7521-KIT BASE FRONTAL IZQ. Y DER. CHEVROLET MATIZ	7522 COMPLEMENTO SOPORTE MOTOR TRAS. AUT. TOYOTA YARIS

<p>7523</p> <p>SOPORTE MOTOR FRONTAL CIVIC, CR-V</p>	<p>7524</p> <p>SOPORTE MOTOR DERECHO CHEVROLET SPARK</p>	<p>7525</p> <p>SOPORTE MOTOR FRONTAL (TURBO) CHEVROLET CRUZE</p>	<p>7526</p> <p>SOPORTE MOT. TRASERO HYUNDAI TUCKSON, IX35</p>	<p>7527</p> <p>SOPORTE TRANSMISIÓN HYUNDAI ELANTRA</p>
<p>7528</p> <p>SOPORTE MOTOR FRONTAL HYUNDAI ELANTRA</p>	<p>7529</p> <p>SOPORTE MOTOR TRASERO HYUNDAI ELANTRA</p>	<p>7530</p> <p>SOP. MOTOR DER. SUP. TORQUE STRUT TOYOTA CAMRY</p>	<p>7532-H</p> <p>SOPORTE MOTOR IZQ. Y DER. BMW Z-3, Z-4</p>	<p>7533-H</p> <p>SOPORTE MOTOR DERECHO TOYOTA RAV 4</p>
<p>7534</p> <p>SOPORTE MOTOR FRONTAL TOYOTA COROLLA, MATRIX</p>	<p>7535</p> <p>SOPORTE MOTOR FRONTAL TOYOTA HIGHLANDER</p>	<p>7536</p> <p>SOPORTE MOTOR TRASERO (4X2) TOYOTA RAV 4</p>	<p>7537</p> <p>SOPORTE TRANSMISIÓN MAZDA 3</p>	<p>7538</p> <p>SOPORTE MOTOR TRASERO NISSAN MAXIMA INFINITI I30</p>
<p>7539-KIT</p> <p>BASE FRONTAL IZQ. Y DER. CHEVROLET EQUINOX PONTIAC TORRENT</p>	<p>7540</p> <p>SOPORTE TRANSMISIÓN CHEVROLET SPARK</p>	<p>7541-H</p> <p>SOPORTE MOTOR DERECHO CHEVROLET CAPTIVA EQUINOX, TERRAIN</p>	<p>7542-H</p> <p>SOPORTE MOTOR FRONTAL FORD FIVE HUNDRED, TAURUS MERCURY SABLE, FREESTYLE</p>	<p>7543-H</p> <p>SOPORTE MOTOR TRASERO FORD FIVE HUNDRED, TAURUS MERCURY SABLE, FREESTYLE</p>
<p>7544-EL</p> <p>SOPORTE MOTOR TRASERO HONDA ODYSSEY</p>	<p>7545</p> <p>SOPORTE MOTOR IZQ. Y DER. CHRYSLER RAM 1500 RAM 3500, RAM 4000</p>	<p>7546</p> <p>SOPORTE MOTOR DER. SUP. NISSAN SENTRA</p>	<p>7547</p> <p>SOP. MOTOR IZQ. Y DER. NISSAN FRONTIER, X-TERRA PATHFINDER</p>	<p>7548</p> <p>SOP. P/BARRA DE TORSIÓN CHEVROLET SUBURBAN CADILLAC ESCALADE</p>
<p>7549-9</p> <p>REP. SOPORTE MOTOR TRAS. VW SHARAN SEAT ALHAMBRA</p>	<p>7550-9</p> <p>REP. SOP. MOT. FRON. TRAS. HYUNDAI ATOS</p>	<p>7551-9</p> <p>REP. SOP. TRANSMISIÓN HYUNDAI ATOS</p>	<p>7552</p> <p>SOPORTE TRANSMISIÓN STD., AUT. Y CVT NISSAN ALTIMA, MAXIMA</p>	<p>7553</p> <p>SOP. TRANSMISIÓN (DIESEL) FORD TRANSIT</p>



7554-H <p>SOPORTE MOTOR DERECHO MAZDA CX-7</p>	7555 <p>COMPLEMENTO SOPORTE MOTOR TRASERO AUT. (7499) CHEVROLET SONIC, TRAX BUICK ENCORE</p>	7556 <p>COMPLEMENTO SOPORTE MOTOR TRAS. STD. (7499) CHEVROLET SONIC</p>	7557 <p>SOPORTE TRANSMISIÓN FRONTAL INF. ACURA TSX HONDA ACCORD, CROSSTOUR</p>	7558 <p>SOPORTE MOTOR TRASERO FORD EDGE, LINCOLN MKX</p>
7559-H <p>SOP. MOTOR FRONTAL BUICK ENCLAVE CHEVROLET TRAVERSE ACADIA, SATURN OUTLOOK</p>	7560-H <p>SOP. MOTOR DER. (DIESEL) FORD TRANSIT</p>	7561-H <p>SOPORTE MOTOR DERECHO NISSAN ALTIMA, MAXIMA</p>	7562-H <p>SOPORTE TRANSMISIÓN CHEVROLET MALIBU PONTIAC G6, SATURN AURA</p>	7563-H <p>SOPORTE MOTOR DERECHO CHEVROLET MALIBU PONTIAC G6, SATURN AURA</p>
7564-H <p>SOPORTE MOTOR DERECHO BMW 535i, 540i, 704il, 728i 730i, 740i, 740il, 750i, 750il, M5</p>	7565-H <p>SOPORTE MOTOR IZQUIERDO BMW 535i, 540i, 704il, 728i 730i, 740i, 740il, 750i, 750il, M5</p>	7566-H <p>SOPORTE MOTOR IZQ. Y DER. FORD THUNDERBIRD JAGUAR S-TYPE, LINCOLN LS</p>	7567-H <p>CHRYSLER CARAVAN GRAND CARAVAN, VOYAGER GRAND VOYAGER, VW ROUTAN</p>	7568 <p>SOPORTE MOTOR TRASERO TRANS. STD, CVT (HIBRIDO) HONDA CITY, FIT, CR-Z</p>
7569 <p>SOPORTE MOTOR TRASERO TRANSMISIÓN AUT. HONDA CITY, FIT</p>	7570 <p>SOPORTE MOTOR TRAS. INF. HONDA CR-V</p>	7571 <p>SOPORTE MOTOR IZQ. (NP-300 DIESEL) NISSAN D-22</p>	7572-KIT <p>BASE FRONTAL IZQ. Y DER. HONDA CR-V</p>	7573-KIT <p>BASE FRONTAL IZQ. Y DER. HONDA CIVIC, CR-X</p>
7574-KIT <p>BASE FRONTAL IZQ. Y DER. HONDA CIVIC, CR-V, CR-X ELEMENT</p>	7575 <p>SOPORTE MOTOR TRASERO HYUNDAI i10</p>	7576 <p>SOPORTE MOTOR DERECHO SEAT ALHAMBRA VW SHARAN</p>	7577 <p>SOPORTE TRANSMISIÓN CHRYSLER RAM 3500 RAM 4000</p>	7578 <p>SOPORTE TRANSMISIÓN VW AMAROK</p>
7579-H <p>SOPORTE MOTOR DERECHO MINI COOPER</p>	7580-H <p>SOPORTE MOTOR IZQUIERDO FORD F-100, F-150, F-350 LOBO, LINCOLN MARK</p>	7581 <p>SOP. TRANS. IZQ. Y DER. STD. AUDI A4 QUATTRO, A4 VW PASSAT</p>	7582 <p>SOP. TRANS. IZQ. Y DER. AUT. AUDI A4, A4 QUATTRO, A6 A6 QUATTRO, S4 VW PASSAT</p>	7583 <p>SOPORTE MOTOR TRASERO CHEVROLET SPARK</p>

<p>7583-9 <i>NUEVO</i></p> <p>REP. SOPORTE MOTOR TRAS. CHEVROLET SPARK</p>	<p>7584 <i>NUEVO</i></p> <p>SOP. TRANSMISIÓN (4X4) CHRYSLER DAKOTA, RAM 1500 RAM 2500, MITSUBISHI RAIDER</p>	<p>7585-H <i>NUEVO</i></p> <p>SOP. MOTOR IZQ. Y DER. BUICK LUCERNE CADILLAC CTS, SRX, STS</p>	<p>7586 <i>NUEVO</i></p> <p>SOPORTE MOTOR DERECHO HONDA ODYSSEY, PILOT</p>	<p>7587 <i>NUEVO</i></p> <p>SOPORTE MOTOR TRASERO CHEVROLET TRAVERSE ACAIDA, BUICK ENCLAVE SATURN OUTLOOK</p>
<p>7588 <i>NUEVO</i></p> <p>SOPORTE TORSIÓN DER. (4X2) TOYOTA SIENNA</p>	<p>7589 <i>NUEVO</i></p> <p>SOPORTE TRANSMISIÓN MERCEDES BENZ C230 C250, C280, E250, E280</p>	<p>7590 <i>NUEVO</i></p> <p>SOP. TRANSMISIÓN FRONTAL ACURA TL, HONDA ACCORD</p>	<p>7591-KIT <i>NUEVO</i></p> <p>BASE FRONTAL IZQ. Y DER. HONDA CITY, CR-Z, FIT INSIGHT</p>	<p>7592-KIT <i>NUEVO</i></p> <p>BASE FRONTAL IZQ. Y DER. TOYOTA PRIUS-C, SCION-XD, YARIS</p>
<p>7593-KIT <i>NUEVO</i></p> <p>BASE FRONTAL IZQUIERDA CHRYLSER 300, 300-C, CHALLENGER CHARGER, MAGNUM</p>	<p>7594-KIT <i>NUEVO</i></p> <p>BASE FRONTAL DERECHA CHRYLSER 300, 300-C, CHALLENGER CHARGER, MAGNUM</p>	<p>7595-KIT <i>NUEVO</i></p> <p>BASE FRONTAL IZQ. Y DER. TOYOTA YARIS, ECHO</p>	<p>7596-KIT <i>NUEVO</i></p> <p>BASE FRONTAL IZQ. Y DER. CHRYLSER 200, AVENGER, CIRRUS JOURNEY, SEBRING</p>	<p>7597 <i>NUEVO</i></p> <p>BASE FRONTAL IZQ. Y DER. MAZDA 6, FORD FUSION, MERCURY MILAN LINCOLN MKZ, ZEPHYR</p>
<p>7598-KIT <i>NUEVO</i></p> <p>BASE FRONTAL IZQ. Y DER. TOYOTA RAV-4</p>	<p>7599-9 <i>NUEVO</i></p> <p>REP. SOP. MOT. IZQ. Y DER. FORD EXPEDITION, F150, F250 F350, LINCOLN NAVIGATOR</p>	<p>7600 <i>NUEVO</i></p> <p>SOPORTE MOTOR TRAS. DER. MINI COOPER</p>	<p>7601-H <i>NUEVO</i></p> <p>SOPORTE MOTOR DERECHO FORD LOBO, F100, F150, F350 ECONOLINE CLUB WAGON LINCOLN MARK</p>	<p>7602 <i>NUEVO</i></p> <p>SOPORTE MOTOR FRONTAL CHEVROLET MALIBU, IMPALA BUICK LACROSSE, REGAL CADILLAC SRX, XTS</p>
<p>7603 <i>NUEVO</i></p> <p>SOPORTE MOTOR FRONTAL CHEVROLET MALIBU PONTIAC G6</p>	<p>7604 <i>NUEVO</i></p> <p>SOP. DE TORSIÓN DER. SUP. NISSAN ALTIMA</p>	<p>7605 <i>NUEVO</i></p> <p>SOP. MOTOR IZQ. DIESEL NISSAN URVAN (NV-350)</p>	<p>7606 <i>NUEVO</i></p> <p>SOP. MOTOR DER. DIESEL NISSAN URVAN (NV-350)</p>	<p>7607 <i>NUEVO</i></p> <p>SOP. MOTOR IZQ. GASOLINA NISSAN URVAN (NV-350)</p>
<p>7608 <i>NUEVO</i></p> <p>SOP. MOTOR DER. GASOLINA NISSAN URVAN (NV-350)</p>	<p>7609 <i>NUEVO</i></p> <p>SOPORTE TRANSMISIÓN AUDI A6 QUATTRO, RS6, S6</p>	<p>7610 <i>NUEVO</i></p> <p>SOP. TRAS. DIFERENCIAL AUDI A4, A4 QUATTRO, A6 A6 QUATTRO, RS4, S4</p>	<p>7611 <i>NUEVO</i></p> <p>SOPORTE TRANSMISIÓN AUDI A4, A4 QUATTRO</p>	<p>7612 <i>NUEVO</i></p> <p>SOPORTE MOTOR TRASERO MINI COOPER</p>



7613-H <p>SOPORTE MOTOR DERECHO BMW 525i, 528i, 528ix, 530i 535i, 535ix</p>	7614-H <p>SOPORTE MOTOR IZQUIERDO MW 525i, 528i, 528ix, 530i 535i, 535ix</p>	7615-H <p>SOP. MOTOR IZQ. Y DER. BMW X5</p>	7616-H <p>SOPORTE MOTOR DERECHO HYUNDAI ATTITUDE, ACCENT KIA RIO, RIO5</p>	7617 <p>SOPORTE PARA MOTOR TRASERO TORQUE FORD ESCAPE, FOCUS VOLVO C-30, C-70, S-40, V-50</p>
7618 <p>SOP. MOTOR FRONTAL NISSAN ALTIMA, SENTRA SE-R</p>	7619 <p>SOP. TRANSMISIÓN (4X4) TOYOTA RAV-4</p>	7620 <p>SOPORTE TRANSMISIÓN TOYOTA RAV-4</p>	7621 <p>SOPORTE TRANSMISIÓN MERCEDES BENZ ML-320, 350 ML-450, ML-63 AMG, R-63 AMG</p>	7622 <p>SOPORTE TRANSMISIÓN MERCEDES BENZ C-36 AMG C-180, C-200, C-220, C-250</p>
7623 <p>SOPORTE TRANSMISIÓN MERCEDES BENZ ML-270 ML-320, ML-350, ML-400</p>	7624 <p>BASE TRASERA IZQ. Y DER. MERCEDES BENZ C-230 C-250, C-300, C-350</p>	7625 <p>BASE TRASERA IZQ. Y DER. BMW X3</p>	7626 <p>BASE FRONTAL IZQ. Y DER. MINI COOPER</p>	7627-9 <p>ASIENTO PARA RESORTE FRONTAL IZQ. Y DER. VOLVO 8-50, C-30, C-70, S-60 S-70, S-80, V-70, XC-70</p>
7628 <p>SOP. TRANSMISIÓN TOYOTA RAV-4</p>	7629 <p>SOPORTE MOTOR FRONT. INF. TORSIÓN VOLVO S-60, S-80, V-70 XC-70, XC-90</p>	7630-H <p>SOPORTE MOTOR IZQ. Y DER. MERCEDES BENZ C-230 C-280, C-320, E-250, E-320</p>	7631 <p>SOPORTE MOTOR IZQ. Y DER. MITSUBISHI L200</p>	7632 <p>SOPORTE MOTOR DER. SUP. HONDA CR-V</p>
7633-H <p>SOPORTE MOTOR DERECHO HONDA CR-V</p>	7634-KIT <p>BASE FRONTAL IZQ. Y DER. NISSAN X-TERRA, FRONTIER SUZUKI EQUATOR</p>	7635-KIT <p>BASE FRONTAL IZQ. Y DER. NISSAN PATHFINDER INFINITI QX4</p>	7636-KIT <p>BASE FRONTAL IZQ. Y DER. CHEVROLET COBALT PONTIAC G4, G5</p>	7637-KIT <p>BASE TRASERA IZQ. Y DER. NISSAN ALTIMA, MAXIMA MURANO, INFINITI I30, I35</p>
7638-H <p>SOPORTE PARA MOTOR DER. CHEVROLET ESCALADE CHEYENNE, SUBURBAN</p>	7639 <p>SOPORTE TRANSMISIÓN HYUNDAI ACCENT, ATTITUDE KIA RIO, RIO 5</p>	7640 <p>SOPORTE MOTOR TRAS. MITSUBISHI LANCER OUTLANDER</p>	7641 <p>SOPORTE TRANSMISIÓN STD. TOYOTA COROLLA, MATRIX PONTIAC VIBE</p>	7642 <p>SOPORTE MOTOR IZQ. Y DER. TOYOTA HILUX</p>

<p>7643-H</p>  <p>SOPORTE MOTOR DERECHO NISSAN MARCH, NOTE, VERSA</p>	<p>7644</p>  <p>SOPORTE MOTOR TRASERO NISSAN ALTIMA</p>	<p>7644-9</p>  <p>REP. SOP. MOT. TRASERO (7644) NISSAN ALTIMA</p>	<p>7645</p>  <p>SOPORTE TRANSMISIÓN NISSAN FRONTIER, X-TERRA</p>	<p>7646</p>  <p>SOPORTE MOTOR IZQ. Y DER. NISSAN FRONTIER</p>
<p>7647</p>  <p>SOP. TRANSMISIÓN DER. HONDA ACCORD</p>	<p>7648</p>  <p>SOP. MOTOR DERECHO SUP. HONDA CR-V</p>	<p>7649</p>  <p>SOP. MOTOR TRASERO HONDA CR-V</p>	<p>7650</p>  <p>SOP. TRANSMISIÓN HONDA CR-V</p>	<p>7651-H</p>  <p>SOP. TRANSMISIÓN FORD FUSION, LINCOLN MKZ ZEPHYR, MAZDA 6 MERCURY MILAN</p>
<p>7651-9</p>  <p>REP. SOP. TRANSMISIÓN (7651) FORD FUSION, LINCOLN MKZ ZEPHYR, MAZDA 6 MERCURY MILAN</p>	<p>7652</p>  <p>SOP. MOTOR DERECHO CHEVROLET MATIZ</p>	<p>7653-H</p>  <p>SOP. MOTOR DERECHO ACURA RDX, HONDA CR-V</p>	<p>7654-H</p>  <p>SOP. MOTOR DERECHO AUDI A3, A3 QUATTRO VW BORA, JETTA, PASSAT</p>	<p>7655</p>  <p>SOP. TRANSMISIÓN CHEVROLET MALIBU PONTIAC G6, SATURN AURA</p>
<p>7656</p>  <p>SOP. MOTOR FRONT. STD. NISSAN SENTRA</p>	<p>7657-H</p>  <p>SOP. MOTOR DER. INF. HONDA CIVIC SI, ACURA CSX</p>	<p>7658</p>  <p>SOP. MOTOR TRASERO NISSAN ALTIMA</p>	<p>7659-H</p>  <p>SOP. MOTOR DER. INF. NISSAN SENTRA, JUKE</p>	<p>7660</p>  <p>SOP. MOTOR DER. SUP. TORSIÓN TOYOTA CAMRY SOLARA, LEXUS ES 300, ES 330</p>
<p>7661</p>  <p>SOP. TRANSMISIÓN MAZDA 6</p>	<p>7662</p>  <p>SOPORTE MOTOR TRASERO CHEVROLET MATIZ</p>	<p>7663-H</p>  <p>SOP. MOTOR DERECHO HONDA CR-V</p>	<p>7664</p>  <p>SOP. MOTOR DER. SUP. TORQUE STRUT TOYOTA SIENNA</p>	<p>7665-H</p>  <p>SOP. MOTOR DERECHO MITSUBISHI OUTLANDER</p>
<p>7666</p>  <p>SOP. MOTOR TRASERO 4X4 TOYOTA RAV-4</p>	<p>7667</p>  <p>SOP. MOTOR TRASERO TOYOTA RAV-4</p>	<p>7668</p>  <p>SOP. MOTOR TRASERO TOYOTA RAV-4</p>	<p>7669-H</p>  <p>SOPORTE MOTOR DER. STD. TOYOTA YARIS</p>	<p>7670</p>  <p>SOP. TRANSMISIÓN TRAS. INF. HONDA ODYSSEY</p>



<p>7671 NUEVO</p>  <p>SOP. MOTOR FRONTAL NISSAN ALTIMA, MAXIMA MURANO, PATHFINDER</p>	<p>7672 NUEVO</p>  <p>SOP. MOTOR TRASERO NISSAN ALTIMA, MAXIMA</p>	<p>7673 NUEVO</p>  <p>SOP. MOTOR FRONTAL HONDA CIVIC SI</p>	<p>7674 NUEVO</p>  <p>SOP. MOTOR TRASERO TOYOTA COROLLA, MATRIX PONTIAC VIBE</p>	<p>7675 NUEVO</p>  <p>SOP. MOTOR FRONTAL HONDA CR-V</p>
<p>7676 NUEVO</p>  <p>SOP. TRANSMISIÓN HONDA ODYSSEY, PILOT</p>	<p>7677 NUEVO</p>  <p>SOP. TRANSMISIÓN FRONTAL INFERIOR HONDA ODYSSEY</p>	<p>7678 NUEVO</p>  <p>SOP. TRANSMISIÓN TRAS. INF. HONDA ODYSSEY</p>	<p>7679-H NUEVO</p>  <p>SOP. MOTOR FRONTAL HONDA ACCORD</p>	<p>7680 NUEVO</p>  <p>SOP. MOTOR TRASERO ACURA TLX, HONDA ACCORD</p>
<p>7681 NUEVO</p>  <p>SOP. TRANSMISIÓN INF. HONDA ACCORD</p>	<p>7682 NUEVO</p>  <p>SOP. MOTOR IZQUIERDO HONDA ACCORD</p>	<p>7683 NUEVO</p>  <p>SOP. MOTOR TRASERO STD. HONDA ACCORD, PRELUDE</p>	<p>7684 NUEVO</p>  <p>SOP. MOTOR TRASERO STD. HONDA ACCORD, ACURA CL</p>	<p>7685 NUEVO</p>  <p>SOP. MOTOR DERECHO HONDA PASSPORT ISUZU AMIGO, PICK UP</p>
<p>7686 NUEVO</p>  <p>SOP. MOTOR IZQUIERDO ACURA SLX, HONDA PASSPORT ISUZU RODEO, TROOPER</p>	<p>7687 NUEVO</p>  <p>SOP. MOTOR FRONTAL MITSUBISHI LANCER OUTLANDER</p>	<p>7688 NUEVO</p>  <p>SOP. MOTOR IQZ. Y DER. NISSAN FRONTIER, X-TERRA</p>	<p>7689 NUEVO</p>  <p>SOP. TRANSMISIÓN FORD ESCAPE, FOCUS TRANSIT CONNECT</p>	<p>7690 NUEVO</p>  <p>SOP. MOT. IQZ. Y DER. TOYOTA 4 RUNNER, T-100 PICK UP, TACOMA</p>
<p>7691 NUEVO</p>  <p>SOP. MOTOR FRONTAL CHEVROLET CAPTIVA EQUINOX, GMC TERRAIN</p>	<p>7692 NUEVO</p>  <p>SOP. MOTOR FRONTAL CHEVROLET CAPTIVA EQUINOX, GMC TERRAIN</p>	<p>7693-H NUEVO</p>  <p>SOP. MOTOR DERECHO NISSAN SENTRA SE-R, ROGUE X-TRAIL, RENAULT KOLEOS</p>	<p>7694 NUEVO</p>  <p>SOP. MOTOR TRASERO SUZUKI SWIFT</p>	<p>7695 NUEVO</p>  <p>SOP. MOTOR DERECHO TOYOTA COROLLA, MATRIX PONTIAC VIBE</p>
<p>7696 NUEVO</p>  <p>SOP. MOTOR TRASERO TOYOTA COROLLA CHEVROLET GEO PRIZM</p>	<p>7697 NUEVO</p>  <p>SOP. MOTOR IZQ. Y DER. CHEVROLET SILVERADO 1500 TAHOE, GMC SIERRA 1500 YUKON</p>	<p>7698-H NUEVO</p>  <p>SOP. MOTOR IZQ. Y DER. CHRYSLER 300, CHALLENGER CHARGER, MAGNUM</p>	<p>7699 NUEVO</p>  <p>SOP. MOTOR TRASERO NISSAN ALTIMA, MAXIMA MURANO, PATHFINDER QUEST</p>	<p>7700-H NUEVO</p>  <p>SOP. MOTOR DERECHO RENAULT DUSTER</p>











<p>7701</p>  <p>SOP. MOTOR FRONTAL DER. TOYOTA CAMRY, VENZA LEXUS ES 350, RX-350, RX-450H</p>	<p>7702</p>  <p>SOP. TRANSMISIÓN FORD EXPLORER MERCURY MOUNTAINEER</p>	<p>7703</p>  <p>SOP. MOTOR DER. SUP. TORQUE STRUT TOYOTA CAMRY, SOLARA</p>	<p>7704-H</p>  <p>SOP. MOTOR TRASERO HONDA ACCORD, ODYSSEY</p>	<p>7705-H</p>  <p>SOP. MOTOR DER. AUT. TOYOTA YARIS</p>
<p>7706</p>  <p>SOP. MOTOR FRONTAL DER. TOYOTA AVALON, CAMRY</p>	<p>7707</p>  <p>SOP. TRANSMISIÓN STD. HONDA CITY, FIT</p>	<p>7708</p>  <p>SOP. TRANS. FRONT. INF. TOYOTA AVALON, CAMRY SIENNA, VENZA, LEXUS ES 350</p>	<p>7708-H</p>  <p>SOP. TRANS. FRONT. INF. TOYOTA AVALON, CAMRY VENZA, SIENNA, LEXUS ES 350</p>	<p>7709-H</p>  <p>SOP. MOTOR FRONTAL ACURA CL, TL HONDA ACCORD</p>
<p>7710</p>  <p>SOP. MOTOR DERECHO HONDA FIT, CITY</p>	<p>7711</p>  <p>SOP. TRANSMISIÓN NISSAN ALTIMA</p>	<p>7712</p>  <p>SOP. TRANSMISIÓN HONDA CIVIC SI</p>	<p>7713</p>  <p>SOP. MOTOR TRASERO SUZUKI SX4</p>	<p>7713-9</p>  <p>REP. SOP. MOTOR TRASERO (7713) SUZUKI SX4</p>
<p>7714</p>  <p>SOP. MOTOR FRONTAL SUZUKI SX4</p>	<p>7714-9</p>  <p>REP. SOP. MOTOR FRONTAL (7714) SUZUKI SX4</p>	<p>7715-9</p>  <p>REP. SOP. TRANSMISIÓN AUT. FORD FUSIÓN MERCURY MILAN</p>	<p>7716-9</p>  <p>REP. SOP. MOTOR FRONTAL CHRYSLER CARAVAN GRAND CARAVAN, VOYAGER GRAND VOYAGER, ROUTAN</p>	<p>7717-9</p>  <p>REP. SOP. MOT. DER. (OVALADO) FORD F-350, F-450, F-550</p>
<p>7718-H</p>  <p>SOP. MOTOR TRASERO HONDA ACCORD</p>	<p>7719-H</p>  <p>SOP. TRANSMISIÓN NISSAN SENTRA SE-R ROGUE, X-TRAIL</p>	<p>7720-H</p>  <p>SOP. MOTOR DERECHO NISSAN ROGUE, X-TRAIL</p>	<p>7721</p>  <p>SOP. MOTOR TRASERO TORQUE STRUT NISSAN ROGUE, X-TRAIL</p>	<p>7722</p>  <p>SOP. MOTOR DER. SUP. TORQUE STRUT NISSAN ROGUE, X-TRAIL</p>
<p>7723-9</p>  <p>REP. SOP. MOTOR TRASERO CHRYSLER CARAVAN GRAND CARAVAN, VOYAGER GRAND VOYAGER, VW ROUTAN</p>	<p>7724</p>  <p>SOP. MOTOR TRASERO ACURA MDX HONDA RIDGELINE, PILOT</p>	<p>7725-H</p>  <p>SOP. MOTOR FRONT. INF. IZQ. TOYOTA AVALON, CAMRY SIENNA, VENZA</p>	<p>7726</p>  <p>SOP. MOTOR FRONTAL TOYOTA RAV-4</p>	<p>7728</p>  <p>SOP. TRANSMISIÓN SUZUKI SX4</p>



7729  NUEVO SOP. MOTOR DERECHO SUZUKI SX4	7730  NUEVO SOP. MOT. TRASERO TRANS. AUT. TORQUE STRUT MAZDA 2	7731  NUEVO SOP. TRANSMISIÓN AUT. MAZDA 2	7732  NUEVO SOP. MOTOR DER. SUP. TORQUE STRUT LARGO 4X4 TOYOTA HIGHLANDER	7733  NUEVO SOP. MOTOR DER. SUP. TORQUE STRUT CORTO 4X2 TOYOTA HIGHLANDER
7734  NUEVO SOP. TRANSMISIÓN AUT. CHRYSLER SEBRING, STRATUS MITSUBISHI ECLIPSE, GALANT	7735  NUEVO SOP. MOTOR FRONTAL BUICK ENCLAVE CHEVROLET ACADIA TRAVERSE, SATURN OUTLOOK	7736  NUEVO SOP. TRANSMISIÓN NISSAN FRONTIER, X-TERRA PATHFINDER	7737-H  NUEVO SOP. MOTOR DERECHO MAZDA 3, CX-5	7738  NUEVO SOP. MOTOR DER. SUP. TORQUE STRUT TOYOTA HIGHLANDER
7739  NUEVO SOP. MOT. TRASERO TORQUE STRUT FORD EXPLORER, FLEX TAURUS, LINCOLN MKS, MKT	7740  NUEVO SOP. MOTOR FRONTAL TORQUE STRUT FORD EXPLORER, FLEX LINCOLN MKS, MKT	7741  NUEVO SOP. TRANSMISIÓN MAZDA CX-7, CX-9	7742  NUEVO SOP. TRANSMISIÓN 4X2 TOYOTA 4 RUNNER	7743  NUEVO SOP. MOTOR IZQ. Y DER. NISSAN D-21, PATHFINDER PICK UP
7744  NUEVO SOP. TRANSMISIÓN TOYOTA 4-RUNNER, PICK UP	7745-9  NUEVO REP. SOP. MOTOR TRASERO TOYOTA AVALON, CAMRY SOLARA, LEXUS ES-300	7746  NUEVO SOP. MOT. DER. SUP. TORQUE STRUT ACURA CSX, HONDA CIVIC SI	7747  NUEVO SOP. MOTOR FRONTAL STD. HONDA ACCORD, ACURA CL	7748  NUEVO SOP. MOTOR IZQUIERDO ISUZU AMIGO, PICK UP TROOPER
7749  NUEVO SOP. TRANSMISIÓN STD. CHRYSLER CALIBER JEEP COMPASS, PATRIOT MITSUBISHI LANCER	7750  NUEVO SOP. MOTOR DERECHO SUZUKI SWIFT	7751  NUEVO SOP. MOTOR FRONTAL SUZUKI SWIFT	7752  NUEVO SOP. MOTOR TRASERO CHRYSLER SEBRING COUPE STRATUS MITSUBISHI ECLIPSE, GALANT	7754  NUEVO SOP. TRANSMISIÓN TOYOTA AVANZA
7755  NUEVO SOP. MOTOR TRASERO AUT. TOYOTA COROLLA	7756  NUEVO SOP. TRANSMISIÓN AUT. HONDA CITY, FIT	7757  NUEVO SOP. MOTOR DER. SUP. TORQUE STRUT TOYOTA AVALON, CAMRY SOLARA, LEXUS ES-300	7758  NUEVO SOP. MOTOR FRONTAL AUT. TOYOTA CAMRY	7759  NUEVO SOP. MOT. TRAS. REFORZADO FORD ESCAPE, FOCUS VOLVO C-30, C-70, S-40, V-50

<p>7760-H</p>  <p>SOP. TRANSMISIÓN BUICK ALLURE, LACROSS REGAL, VERANO CHEVROLET IMPALA, MALIBU CADILLAC SRX, XTS</p>	<p>7761-H</p>  <p>SOP. MOTOR DERECHO CADILLAC SRX</p>	<p>7763</p>  <p>SOP. MOTOR DERECHO HONDA CIVIC HIBRIDO</p>	<p>7764</p>  <p>SOP. TRANSMISIÓN AUT. HONDA CITY, FIT</p>	<p>7765</p>  <p>SOP. MOTOR DER. TRASERO CHRYSLER CALIBER JEEP COMPASS PATRIOT MITSUBISHI, OUTLANDER</p>
<p>7766</p>  <p>SOP. TRANSMISIÓN FORD EDGE, FUSION LINCOLN MKZ, ZEPHYR</p>	<p>7767</p>  <p>SOP. MOTOR TRASERO HONDA CITY, FIT, HRV</p>	<p>7768</p>  <p>COMPLEMENTO PARA SOP. MOTOR TRASERO MAZDA 3 Y 5</p>	<p>7769</p>  <p>SOP. MOTOR DER. SUP. TORQUE STRUT TOYOTA HIGHLANDER</p>	<p>7770</p>  <p>SOP. TRANSMISIÓN VW POLO, VENTO</p>
<p>7771-H</p>  <p>SOP. MOTOR DERECHO BUICK ALLURE, LACROSSE CHEVROLET IMPALA, MALIBU</p>	<p>7772-H</p>  <p>SOP. MOTOR DERECHO BUICK REGAL CHEVROLET IMPALA, MALIBU</p>	<p>7773</p>  <p>SOP. MOTOR TRASERO TORQUE STRUT VW POLO, VENTO</p>	<p>7774</p>  <p>SOP. MOTOR TRASERO AUT. TOQUE STRUT MAZDA 3, 6, CX-5</p>	<p>7775</p>  <p>SOP. TRANSMISIÓN 4X4 DIESEL Y GASOLINA MITSUBISHI L200</p>
<p>7776</p>  <p>SOP. MOTOR TRASERO STD. TORQUE STRUT AUDI TT QUATTRO, VW BORA, JETTA BICENTENARIO</p>	<p>7777-H</p>  <p>SOP. MOTOR DERECHO MAZDA 6</p>	<p>7778</p>  <p>SOP. TRANSMISIÓN STD. HONDA CITY, FIT</p>	<p>7779</p>  <p>SOP. MOTOR IZQ. Y DER. FORD RANGER MAZDA B-3000, B-4000</p>	<p>7780-H</p>  <p>SOP. MOTOR DERECHO CHEVROLET PRIZM TOYOTA COROLLA</p>
<p>7782-9</p>  <p>REP. SOP. MOTOR TRASERO TOYOTA CAMRY, SIENNA SOLARA, LEXUS ES-300</p>	<p>7783-H</p>  <p>SOP. MOTOR DERECHO RENAULT SANDERO STEPWAY</p>	<p>7784</p>  <p>SOP. MOTOR FRONTAL CHRYSLER SEBRING STRATUS, MITSUBISHI ECLIPSE GALANT</p>	<p>7786</p>  <p>SOP. MOTOR TRASERO CHRYLSEER SEBRING STRATUS, MITSUBISHI ECLIPSE, GALANT</p>	<p>7787</p>  <p>SOP. MOTOR FRONTAL EAGLE TALON CHRYSLER AVENGER SEBRING, MITSUBISHI ECLIPSE</p>
<p>7788</p>  <p>SOP. MOTOR DERECHO EAGLE TALON MITSUBISHI ECLIPSE, GALANT</p>	<p>7789-H</p>  <p>SOP. MOTOR DERECHO ACURA TLX HONDA ACCORD</p>	<p>7790</p>  <p>SOP. MOTOR IZQUIERDO JEEP COMMANDER GRAND CHEROKEE</p>	<p>7791</p>  <p>SOP. MOTOR DERECHO JEEP COMMANDER GRAND CHEROKEE</p>	<p>7792</p>  <p>SOP. MOTOR TRASERO TORQUE STRUT ACURA CSX, HONDA CIVIC SI</p>



7793   SOP. MOTOR FRONTAL TOYOTA CAMRY, VENZA	7796   SOP. TRANSMISIÓN STD. FRONTAL INFERIOR HONDA ACCORD	7797-H   SOP. MOTOR IZQ. Y DER. SUZUKI GRAND VITARA	7798   SOP. MOTOR IZQ. Y DER. CHEVROLET SIERRA 2500 SIERRA 3500, SILVERADO 2500 SILVERADO 3500	7799   SOP. MOT. FRONT. STD. Y AUT. SATURN SC1, SC2, SL, SL1 SL2, SW1, SW2
9084  BUJE PARA MUELLE TRAS. NISSAN D-21	9085  BUJE PARA MUELLE TRAS. NISSAN D-21	9087  GOMA VARILLA ESTAB. CAMIONETAS CHEVROLET	9094  BUJE PARA MUELLE CHEVROLET CAMIONETAS	9122  BUJE PARA MUELLE ESTRIADA NISSAN CAMIONETAS
9123  BUJE PARA MUELLE TRASERA NISSAN D-21	9124  GOMA PARA MUELLE NISSAN D-21	9126 89, 282  BUJE PARA MUELLE ISUZU TROOPER, CHEVROLET LUV	9127  BUJE PARA MUELLE TOYOTA BJ-40	9128  BUJE PARA MUELLE TOYOTA BJ-70
9129  BUJE PARA MUELLE TOYOTA PICK UP	9130  BUJE MUELLE TOYOTA COASTER, NISSAN URVAN	9131  BUJE PARA MUELLE TOYOTA HJ-45	9132  BUJE PARA MUELLE NISSAN D-21	9133  BUJE PARA MUELLE CORTO MITSUBISHI VARIOS
9134  BUJE PARA MUELLE LARGO MITSUBISHI VARIOS	9136  BUJE HORQUILLA SUPERIOR NISSAN CAMIONETAS	9138  BUJE PARA MUELLE NISSAN VARIOS	9145  BUJE PARA MUELLE FORD F-100	9146  BUJE PARA MUELLE VAM RAMBLER
9147  GOMA PARA AMORTIGUADOR UNIVERSAL	9148  GOMA PARA AMORTIGUADOR UNIVERSAL	9149  GOMA PARA AMORTIGUADOR UNIVERSAL	9154  BUJE PARA MUELLE NISSAN, D-21, ICHI-VAN	9155  BUJE PARA MUELLE NISSAN, D-21, ICHI-VAN

<p>9158</p> <p>BUJE DE MUELLE (HULE DE BALANCIN) TOYOTA HI-LUX LN65</p>	<p>9160</p> <p>BUJE PARA MUELLE NISSAN, D-21, ISUZU AMIGO</p>	<p>9161</p> <p>BUJE DE MUELLE FRONTAL Y TRASERO DELG. LISO, SUZUKI ARIOS</p>	<p>9162</p> <p>BUJE DE MUELLE FRONTAL Y TRAS. GRUESO ASTRIADO, SUZUKI VARIOS</p>	<p>9163</p> <p>GOMA PARA AMORTIGUADOR NISSAN 620, D-21 TOYOTA LAND CRUISER</p>
<p>9164</p> <p>BUJE DE MUELLE NISSAN 620, 720 LISO PEQ.</p>	<p>9165</p> <p>GOMA PARA AMORTIGUADOR TOYOTA HI-LUX</p>	<p>9166</p> <p>BUJE PARA MUELLE ISUZU UNIVERSAL</p>	<p>9167</p> <p>GOMA PARA TORNILLO ESTABILIZADOR UNIVERSAL VARIOS</p>	<p>9168</p> <p>BUJE PARA TORNILLO TENSOR TOYOTA CROWN, HI-LUX</p>
<p>9169</p> <p>BUJE DE MUELLE, MITSUBISHI LANCER, GALANT, L-200</p>	<p>9170</p> <p>BUJE TENSOR (TIPO YOYO) NISSAN 720, D21, PATHFINDER</p>	<p>9171</p> <p>GOMA PARA BARRA EST. TOYOTA HI-LUX, MAZDA SERIES B2000</p>	<p>9173</p> <p>BUJE P/BRAZO SUPERIOR TOYOTA 4X4, ISUZU FASTER Z</p>	<p>9176</p> <p>BUJE DE YUGO (PUENTE) TRAS. HYUNDAI EXCEL EXT.</p>
<p>9177</p> <p>BUJE PARA YUGO EXTERNO PUENTE TRASERO HYUNDAI EXCEL</p>	<p>9191</p> <p>BUJE DE MUELLE NISSAN 720, D-21, PATHFINDER</p>	<p>9209</p> <p>GOMA PARA SOPORTE FLECHA CARDAN 9219 CHEVROLET DENALI, YUKON</p>	<p>9210</p> <p>BUJE HORQ. INF. CHICO NISSAN URVAN</p>	<p>9211</p> <p>BUJE HORQ. INF. GRANDE NISSAN URVAN</p>
<p>9212</p> <p>BUJE HORQ. SUPERIOR (CONICO) NISSAN URVAN</p>	<p>9219</p> <p>SOP. PARA FLECHA CARDAN GOMA 9209 CON BALERO 88508 CHEVROLET DENALI</p>	<p>9226</p> <p>GOMA PARA SOP. FLECHA CARDAN 9411 CHEVROLET C-15, C-1500</p>	<p>9232</p> <p>BUJE PARA HORQUILLA INF. CHICO HONDA CIVIC</p>	<p>9233</p> <p>BUJE PARA HORQUILLA INF. HONDA CIVIC</p>
<p>9234</p> <p>BUJE PARA HORQUILLA INF. HONDA CIVIC</p>	<p>9411</p> <p>SOP. PARA FLECHA CARDAN GOMA 9226 CON BALERO 88509 CHEVROLET C-15</p>	<p>9800</p> <p>BUJES PARA HORQUILLA AUDI A3, SEAT IBIZA VW BEETLE</p>	<p>9801</p> <p>BUJES PARA HORQUILLA NISSAN TSURU III, TSUBAME</p>	<p>9802</p> <p>KIT DE BUJES P/SUSPENSION TRASERA CHRYSLER AVENGER JEEP LIBERTY</p>



9802-1   <p>BUJE PARA SUSPENSIÓN TRASERA (GRANDE) CHRYSLER 200, AVENGER JEEP COMPASS</p>	9802-2   <p>BUJE PARA SUSPENSIÓN TRASERA (CHICO) CHRYSLER 200, AVENGER JEEP COMPASS</p>	9803  <p>GOMAS PARA TIRANTE DE SUSPENSIÓN IZQ. Y DER. TOYOTA HIACE</p>	9804  <p>KIT DE BUJES PARA MUELLE TRASERO NISSAN URVAN</p>	9805  <p>BUJES PARA HORQUILLA KIT CHEVROLET AVEO PONTIAC G3</p>
9806  <p>BUJES PARA HORQUILLA KIT NISSAN SENTRA, X-TRAIL RENAULT KOLEOS</p>	9807  <p>BUJES PARA HORQUILLA KIT NISSAN SENTRA, CUBE, TIIDA, MICRA</p>	9808  <p>BUJE PARA HORQUILLA KIT CHEVROLET SPARK</p>	9809  <p>BUJES P/HORQUILLA KIT CON CASQUILLO AUDI A3, SEAT IBIZA, VW JETTA</p>	9811   <p>GOMAS PARA BARRA ESTABILIZADORA NISSAN TIIDA, SENTRA, VERSA</p>
9812   <p>GOMAS PARA BARRA ESTABILIZADORA NISSAN TSURU III, TSUBAME</p>	9813   <p>JGO. DE GOMAS PARA BARRA ESTABILIZADORA TRASERA NISSAN TSURU III, TSUBAME</p>	63100  <p>CUBRE POLVO L. RUEDA IZQ. Y DER. CHEVROLET CHEVY C2</p>	63101  <p>CUBRE POLVO L. CAJA IZQ. Y DER. CHEVROLET CHEVY C2</p>	63102  <p>CUBRE POLVO DE DIRECCIÓN IZQ. Y DER. CHEVROLET CHEVY C2</p>
63103  <p>CUBRE POLVO L. RUEDA IZQ. Y DER. CHEVROLET ASTRA</p>	63104  <p>CUBRE POLVO LADO CAJA IZQ. Y DER. CHEVROLET ASTRA</p>	63105  <p>CUBRE POLVO DE DIRECCIÓN IZQ. Y DER. CHEVROLET ASTRA</p>	63106  <p>CUBRE POLVO DE DIRECCIÓN IZQ. Y DER. CHEVROLET ASTRA</p>	63107  <p>CUBRE POLVO LADO RUEDA IZQ. Y DER. CHEVROLET CORSA</p>
63108  <p>CUBRE POLVO LADO CAJA IZQ. Y DER. CHEVROLET CORSA</p>	63109  <p>CUBRE POLVO LADO CAJA IZQ. Y DER. CHEVROLET CORSA</p>	63110  <p>CUBRE POLVO LADO CAJA IZQ. Y DER. SEAT LEON, TOLEDO VW BORA</p>	63111  <p>CUBRE POLVO LADO RUEDA IZQ. Y DER. SEAT LEON, TOLEDO VW BORA</p>	63112  <p>CUBRE POLVO DIR. HID. IZQ. Y DER. FORD ECOSPORT, EXPLORER</p>
63113  <p>CUBRE POLVO LADO CAJA IZQ. Y DER. TOYOTA TACOMA, 4X2 Y 4X4</p>	63114  <p>LADO CAJA LADO RUEDA IZQ. Y DER. TOYOTA TACOMA</p>	63115  <p>CUBRE POLVO LADO CAJA IZQ. Y DER. CHEVROLET CORSA</p>	63116  <p>CUBRE POLVO LADO CAJA IZQ. Y DER. (TRIPOIDE) VW SHARAN</p>	63117  <p>CUBRE POLVO LADO CAJA IZQ. Y DER., VW EUROVAN</p>

<p>63118</p> <p>CUBRE POLVO LADO RUEDA IZQ. Y DER., VW EUROVAN</p>	<p>63119</p> <p>CUBRE POLVO LADO CAJA IZQ. Y DER. (TRIPOIDE) HONDA CIVIC</p>	<p>63120</p> <p>CUBRE POLVO LADO RUEDA IZQ. Y DER. HYUNDAI ATOS</p>	<p>63121</p> <p>CUBRE POLVO LADO CAJA IZQ. Y DER. HYUNDAI ATOS</p>	<p>63123</p> <p>CUBRE POLVO LADO CAJA IZQ. CHRYSLER VOYAGER</p>
<p>63124</p> <p>CUBRE POLVO LADO RUEDA IZQ. Y DER. CHRYSLER VOYAGER</p>	<p>63125</p> <p>CUBRE POLVO LADO CAJA DERECHO CHRYSLER VOYAGER</p>	<p>63128</p> <p>CUBRE POLVO LADO RUEDA IZQ. Y DER. CHEVROLET MALIBU</p>	<p>63129</p> <p>CUBRE POLVO LADO RUEDA IZQ. Y DER. CHEVROLET CRUZE</p>	<p>63130</p> <p>CUBRE POLVO LADO CAJA IZQ. Y DER. CHEVROLET CRUZE</p>
<p>63132</p> <p>CUBRE POLVO LADO CAJA IZQ. Y DER. HONDA CR-V</p>	<p>63133</p> <p>CUBRE POLVO LADO RUEDA IZQ. Y DER. HONDA CR-V</p>	<p>63134</p> <p>CUBRE POLVO IZQ. Y DER. LADO RUEDA CHEVROLET SPARK</p>	<p>63135</p> <p>CUBRE POLVO IZQ. Y DER. LADO CAJA CON TRIPOIDE CHEVROLET SPARK</p>	<p>63136</p> <p>CUBRE POLVO IZQ. Y DER. DE DIRECCION CHEVROLET SPARK</p>
<p>63137</p> <p>CUBRE POLVO IZQ. Y DER. LADO CAJA CHEVROLET MATIZ</p>	<p>63138</p> <p>CUBRE POLVO IZQ. Y DER. LADO RUEDA CHEVROLET AVEO, PONTIAC G3</p>	<p>63139</p> <p>CUBRE POLVO IZQ. Y DER. LADO CAJA CHEVROLET AVEO, PONTIAC G3</p>	<p>63140</p> <p>CUBRE POLVO IZQ. Y DER. DE DIRECCION CHEVROLET AVEO, PONTIAC G3</p>	<p>63141</p> <p>CUBRE POLVO LADO RUEDA IZQ. Y DER. NISSAN TIIDA</p>
<p>63142</p> <p>CUBRE POLVO LADO CAJA IZQ. Y DER. (CON TRIPOIDE) NISSAN TIIDA</p>	<p>63143</p> <p>CUBRE POLVO DE DIR. IZQ. Y DER. NISSAN TIIDA</p>	<p>63144</p> <p>CUBRE POLVO LADO RUEDA IZQ. Y DER. NISSAN VERSA, NOTE</p>	<p>63145</p> <p>CUBRE POLVO LADO CAJA IZQ. Y DER. (TRIPOIDE) NISSAN VERSA, NOTE</p>	<p>63146</p> <p>CUBRE POLVO DE DIR. IZQ. Y DER. NISSAN VERSA, NOTE</p>
<p>63147</p> <p>CUBRE POLVO LADO RUEDA IZQ. Y DER. VW CROSSFOX, GOL, LUPO</p>	<p>63148</p> <p>CUBRE POLVO LADO CAJA IZQ. Y DER. VW CROSSFOX, GOL, LUPO</p>	<p>63149</p> <p>CUBRE POLVO DE DIR. IZQ. Y DER. VW CROSSFOX, GOL, LUPO</p>	<p>63150</p> <p>CUBRE POLVO LADO CAJA IZQ. Y DER. (CON TRIPOIDE) NISSAN MARCH</p>	<p>63151</p> <p>CUBRE POLVO DE DIR. IZQ. Y DER. NISSAN MARCH</p>



63152 <i>NUEVO</i> CUBRE POLVO LADO RUEDA IZQ. Y DER. NISSAN X-TRAIL	63153 <i>NUEVO</i> CUBRE POLVO LADO CAJA IZQ. Y DER. (CON TRIPOIDE) NISSAN X-TRAIL	63154 <i>NUEVO</i> CUBRE POLVO LADO CAJA IZQ. Y DER. (CON TRIPOIDE) HYUNDAI i 10	63155 <i>NUEVO</i> CUBRE POLVO LADO RUEDA IZQ. Y DER. HYUNDAI i 10	63156 <i>NUEVO</i> CUBRE POLVO LADO RUEDA IZQ. Y DER. MITSUBISHI OUTLANDER
63157 <i>NUEVO</i> CUBRE POLVO LADO CAJA IZQ. Y DER. MITSUBISHI OUTLANDER	63158 <i>NUEVO</i> CUBRE POLVO DE DIR. IZQ. Y DER. MITSUBISHI OUTLANDER	63159 <i>NUEVO</i> CUBRE POLVO LADO RUEDA IZQ. Y DER. MITSUBISHI OUTLANDER	63160 <i>NUEVO</i> CUBRE POLVO LADO CAJA IZQ. Y DER. MITSUBISHI OUTLANDER	63161 <i>NUEVO</i> CUBRE POLVO LADO CAJA IZQ. Y DER. NISSAN ROGUE, 370-Z
63162 <i>NUEVO</i> CUBRE POLVO LADO RUEDA IZQ. Y DER. NISSAN ROGUE, 370-Z	63163 <i>NUEVO</i> CUBRE POLVO DE DIR. IZQ. Y DER. NISSAN ROGUE	63164 <i>NUEVO</i> CUBRE POLVO LADO CAJA STD. IZQ. Y DER. (TRIPOIDE) JEEP PATRIOT, COMPASS	63165 <i>NUEVO</i> CUBRE POLVO LADO RUEDA IZQ. Y DER. DODGE CHRYSLER, JEEP	63166 <i>NUEVO</i> CUBRE POLVO LADO CAJA AUT. IZQ. Y DER. (TRIPOIDE) DODGE CHRYSLER, JEEP
63167 <i>NUEVO</i> CUBRE POLVO LADO RUEDA IZQ. Y DER. NISSAN APRIO	63168 <i>NUEVO</i> CUBRE POLVO LADO CAJA IZQ. Y DER. (CON TRIPOIDE) NISSAN APRIO	63169 <i>NUEVO</i> CUBRE POLVO IZQ. Y DER. (TRIPOIDE) LADO CAJA RENAULT SANDERO, STEPWAY	63171 <i>NUEVO</i> CUBRE POLVO LADO CAJA IZQ. Y DER. (TRIPOIDE) CHEVROLET AVEO PONTIAC G3	63173 <i>NUEVO</i> CUBRE POLVO LADO RUEDA IZQ. Y DER. NISSAN ALTIMA SENTRA, X-TRAIL, ROGUE RENAULT KOLEOS
63174 <i>NUEVO</i> CUBRE POLVO LADO CAJA IZQ. Y DER. (CON TRIPOIDE) NISSAN SENTRA, ALTIMA	63175 <i>NUEVO</i> CUBRE POLVO DE DIR. IZQ. Y DER. NISSAN SENTRA	63176 <i>NUEVO</i> CUBRE POLVO LADO CAJA IZQ. Y DER. (CON TRIPOIDE) NISSAN ALTIMA, MAXIMA	63177 <i>NUEVO</i> CUBRE POLVO DE DIR. DER. NISSAN ALTIMA, MAXIMA	63178 <i>NUEVO</i> CUBRE POLVO DE DIR. IZQ. NISSAN ALTIMA, MAXIMA
63179 <i>NUEVO</i> CUBRE POLVO LADO RUEDA IZQ. Y DER. NISSAN MURANO	63180 <i>NUEVO</i> CUBRE POLVO LADO CAJA IZQ. Y DER. (CON TRIPOIDE) NISSAN MURANO	63181 <i>NUEVO</i> CUBRE POLVO LADO RUEDA IZQ. Y DER. NISSAN JUKE	63182 <i>NUEVO</i> CUBRE POLVO DE DIR. IZQ. NISSAN JUKE, LEAF	63183 <i>NUEVO</i> CUBRE POLVO LADO CAJA IZQ. Y DER. (CON TRIPOIDE) NISSAN JUKE

<p>63184 </p>  <p>CUBRE POLVO LADO RUEDA IZQ. Y DER. VW SHARAN, SEAT ALHAMBRA</p>	<p>63185 </p>  <p>CUBRE POLVO LADO CAJA IZQ. Y DER. (CON TRIPOIDE) VW SHARAN, SEAT ALHAMBRA</p>	<p>63186 </p>  <p>CUBRE POLVO DE DIR. IZQ. Y DER. VW SHARAN, SEAT ALHAMBRA</p>	<p>63187 </p>  <p>CUBRE POLVO LADO RUEDA IZQ. Y DER. VOLKSWAGEN VENTO</p>	<p>63188 </p>  <p>CUBRE POLVO DE DIR. IZQ. Y DER. VOLKSWAGEN VENTO</p>
<p>63191 </p>  <p>CUBRE POLVO LADO RUEDA IZQ. Y DER. NISSAN ALTIMA, SENTRA</p>	<p>63192 </p>  <p>CUBRE POLVO DE DIR. IZQ. Y DER. NISSAN ALTIMA</p>	<p>63193 </p>  <p>CUBRE POLVO LADO RUEDA IZQ. Y DER. NISSAN QUEST</p>	<p>63194 </p>  <p>CUBRE POLVO LADO CAJA IZQ. Y DER. NISSAN QUEST</p>	<p>63195 </p>  <p>CUBRE POLVO DE DIR. IZQ. Y DER. NISSAN QUEST</p>
<p>63196 </p>  <p>CUBRE POLVO DE DIR. IZQ. Y DER. NISSAN QUEST</p>	<p>64350</p>  <p>GOMA PARA TIRANTE DE SUSPENSION FORD EXPLORER, RANGER</p>	<p>64360</p>  <p>GOMA PARA TIRANTE DE SUSPENSION FORD MODIF.</p>	<p>64370</p>  <p>GOMA PARA TIRANTE DE SUSPENSION FORD EXPLORER, LOBO</p>	<p>64380</p>  <p>NISSAN, DATSUN REPUESTO PARA BRAZO AUXILIAR CAM.</p>
<p>64390</p>  <p>GOMA PARA TIRANTE DE SUSPENSION NISSAN SEDAN</p>	<p>64400</p>  <p>GOMA PARA TIRANTE DE SUSPENSION NISSAN SEDAN, SAKURA</p>	<p>64410</p>  <p>GOMA PARA TIRANTE DE SUSPENSION NISSAN D-21</p>	<p>64420</p>  <p>CACAHUATE P/BARRA ESTAB NISSAN PLATINA RENAULT CLIO</p>	<p>64430</p>  <p>GOMA PARA TIRANTE DE SUSPENSION FORD GRAND MARQUIS</p>
<p>64440</p>  <p>BUJE HORQUILLA SUPERIOR SUP. NISSAN CAMIONETAS</p>	<p>64450</p>  <p>GOMA PARA TIRANTE DE SUSPENSION FORD F-250, F-350</p>	<p>64470</p>  <p>GOMA PARA TIRANTE DE SUSPENSION FORD BRONCO, F-350</p>	<p>64480</p>  <p>GOMA PARA TIRANTE DE SUSPENSION FORD TOPAZ</p>	<p>64490</p>  <p>GOMA PARA TIRANTE DE SUSPENSION CHRYSLER ARIES CARAVAN, VOYAGER</p>
<p>64500</p>  <p>GOMA PARA TIRANTE DE SUSPENSION CHRYSLER D-350, RAM CHARGER</p>	<p>64501</p>  <p>GOMA PARA BARRA ESTABILIZADORA NISSAN URVAN</p>	<p>64510</p>  <p>GOMA PARA TIRANTE DE SUSPENSION NISSAN TSURU II</p>	<p>64520</p>  <p>GOMA PARA TIRANTE DE SUSPENSION NISSAN TSURU II</p>	<p>64550</p>  <p>GOMA PARA TIRANTE DE SUSPENSION FORD MUSTANG, MAVERICK</p>



64560  GOMA PARA TIRANTE DE SUSPENSIÓN FORD MUSTANG	64570  GOMA PARA TIRANTE DE SUSPENSIÓN CHRYSLER DART, LEBARON	64580  GOMA PARA TIRANTE DE SUSPENSIÓN VAM RAMBLER	64590  TORNILLO ESTABILIZADOR CHRYSLER DART, VALIANT	64600  TORNILLO EXCÉNTRICO CHEVROLET NOVA CHRYSLER, DART FORD MAVERICK
64610  BUJE PARA HORQUILLA INF. GRANDE NISSAN TSURU II, SENTRA	64620  TORNILLO ESTABILIZADOR FRONTAL NISSAN TSURU II, TSUBAME	64630  TORNILLO ESTABILIZADOR TRASERO NISSAN TSURU II, TSURU III	64640  REP. PARA TORNILLOS 64620, 64630, 64730 Y 64780	64650  BUJE PARA HORQUILLA VW GOLF, JETTA A4
64651  BUJE PARA HORQUILLA VW GOLF, JETTA A2-A3	64660  BUJE PARA HOQUILLA GRANDE NISSAN TSUBAME, TSURU III	64670  BUJE PARA HORQUILLA TRASERO NISSAN	64680  GOMA PARA BARRA ESTABILIZADORA NISSAN TSURU II	64690  GOMA PARA BARRA ESTABILIZADORA NISSAN TSURU II
64691  GOMA PARA BARRA ESTABILIZADORA CHEVROLET CORSA	64692  GOMA PARA BARRA ESTABILIZADORA, CHRYSLER DURANGO, RAM-3500	64693  GOMA PARA BARRA ESTABILIZADORA CHRYSLER RAM 1500, 2500	64694  GOMA PARA BARRA ESTABILIZADORA REDONDA VW EUROVAN TDI, VR6	64695  GOMA PARA BARRA ESTABILIZADORA IZQ. FORD FIESTA
64696  GOMA PARA BARRA ESTABILIZADORA FORD WINDSTAR	64697  GOMA PARA BARRA ESTABILIZADORA CHEVROLET MALIBU PONTIAC SUNFIRE	64698  GOMA PARA BARRA ESTABILIZADORA (4X2) JEEP CHEROKEE	64699  GOMA PARA BARRA ESTABILIZADORA (4X2 Y 4X4) JEEP LIBERTY	64700  GOMA PARA TIRANTE DE SUSPENSIÓN NISSAN TSURU II
64701  GOMA PARA BARRA ESTABILIZADORA JEEP CHEROKEE	64702  GOMA PARA BARRA ESTABILIZADORA (4X2) NISSAN D-21, FRONTIER	64703  GOMA PARA BARRA ESTAB. 3/4" 4X2 Y 4X4 FORD EXPLORER MERCURY MOUNTAINEER	64704  GOMA PARA BARRA ESTABILIZADORA CHRYSLER RAM 1500	64705  GOMA PARA BARRA ESTABILIZADORA NISSAN ALTIMA, MAXIMA

<p>64706</p>  <p>GOMA PARA BARRA ESTABILIZADORA CHEVROLET TORNADO</p>	<p>64707</p>  <p>GOMA PARA BARRA ESTABILIZADORA CHEVROLET MALIBU</p>	<p>64708</p>  <p>GOMA PARA BARRA ESTABILIZADORA CHEVROLET S-10</p>	<p>64709</p>  <p>GOMA PARA BARRA ESTABILIZADORA SEAT IBIZA, LEÓN</p>	<p>64710</p>  <p>BUJE PARA HORQUILLA SUP. NISSAN ICHI VAN</p>
<p>64711</p>  <p>GOMA PARA BARRA ESTABILIZADORA NISSAN ALTIMA, MAXIMA</p>	<p>64712</p>  <p>GOMA PARA BARRA ESTABILIZADORA CHEVROLET TRAIL BLAZER OLDSMOBILE BRAVADA</p>	<p>64713</p>  <p>GOMA PARA BARRA ESTABILIZADORA 4X4 NISSAN D-21 PICK UP</p>	<p>64714</p>  <p>GOMA PARA BARRA ESTABILIZADORA NISSAN PLATINA RENAULT CLIO</p>	<p>64715</p>  <p>GOMA PARA BARRA ESTABILIZADORA NISSAN ALMERA, SENTRA RENAULT SCALA</p>
<p>64716</p>  <p>GOMA PARA BARRA ESTABILIZADORA FORD, LINCOLN, MERCURY</p>	<p>64717</p>  <p>GOMA PARA BARRA ESTABILIZADORA, CHRYSLER CARAVAN, VOYAGER</p>	<p>64718</p>  <p>GOMA PARA BARRA ESTABILIZADORA CHEVROLET MERIVA, ZAFIRA</p>	<p>64719</p>  <p>GOMA PARA BARRA ESTABILIZADORA IZQ. VOLKSWAGEN</p>	<p>64720</p>  <p>BUJE PARA HORQUILLA INF. VW, CORSAR, POINTER</p>
<p>64721</p>  <p>GOMA PARA BARRA ESTABILIZADORA CHEVROLET VENTURE PONTIAC MONTANA</p>	<p>64722</p>  <p>GOMA PARA BARRA ESTABILIZADORA IZQ. FORD FIESTA, KA</p>	<p>64723</p>  <p>GOMA PARA BARRA ESTABILIZADORA JEEP GRAND CHEROKEE</p>	<p>64724</p>  <p>GOMA PARA BARRA ESTABILIZADORA FORD FIESTA</p>	<p>64726</p>  <p>GOMA PARA BARRA ESTABILIZADORA IZQ. FORD FIESTA</p>
<p>64727</p>  <p>GOMA PARA BARRA ESTABILIZADORA VW POINTER</p>	<p>64728</p>  <p>GOMA PARA BARRA ESTABILIZADORA 4X4 FORD EXPEDITION, LOBO</p>	<p>64729</p>  <p>GOMA PARA BARRA ESTABILIZADORA VW GOLF A2, JETTA A2</p>	<p>64730</p>  <p>TORNILLO ESTABILIZADOR DERECHO NISSAN URVAN</p>	<p>64731</p>  <p>GOMA PARA BARRA ESTABILIZADORA CHEVROLET ASTRA, CORSA</p>
<p>64732</p>  <p>GOMAS PARA BARRA ESTABILIZADORA HONDA CIVIC</p>	<p>64733</p>  <p>GOMA PARA BARRA ESTABILIZADORA CHEVROLET ASTRA, CORSA</p>	<p>64737</p>  <p>GOMA PARA BARRA ESTABILIZADORA CHRYSLER CIRRUS, STRATUS</p>	<p>64738</p>  <p>GOMA PARA BARRA ESTABILIZADORA CHEVROLET MATIZ</p>	<p>64739</p>  <p>GOMA PARA BARRA ESTABILIZADORA VW EUROVAN TDI, VR6</p>



<p>64740</p> <p>BUJE PARA BARRA TRASERA VW GOLF, JETTA A2</p>	<p>64741</p> <p>GOMA P/CAJA DE DIRECCION FORD FOCUS (AMERICA)</p>	<p>64750</p> <p>BUJE PARA BARRA TRASERA VW GOLF Y JETTA A3</p>	<p>64760</p> <p>BUJE PARA HORQUILLA VW GOLF, JETTA A4</p>	<p>64770</p> <p>REP. DE GOMAS PARA BRAZO Ó ROTULA INFERIOR FORD TOPAZ</p>
<p>64780</p> <p>TORNILLO ESTABILIZADOR IZQ. NISSAN URVAN</p>	<p>64790</p> <p>BUJE MUELLE TRASERO NISSAN URVAN</p>	<p>64800</p> <p>BUJE MUELLE TRASERO NISSAN URVAN</p>	<p>64810</p> <p>BUJE EJE TRASERO NISSAN SENTRA, ALMERA</p>	<p>64812</p> <p>BUJE P/HORQUILLA DEL IZQ. Y DER. SEAT IBIZA VW CROSSFOX, LUPO, POLO</p>
<p>64814</p> <p>BUJE P/HORQUILLA CHEVROLET MATIZ</p>	<p>64815</p> <p>GOMA P/CAJA DE DIRECCION VW GOLF A4, JETTA A4</p>	<p>64816</p> <p>GOMA PARA BARRA ESTABILIZADORA DERECHA VW BEETLE, GOLF A4</p>	<p>64820</p> <p>BUJE PARA HORQUILLA VW EUROVAN</p>	<p>64821</p> <p>BUJE PARA EJE TRASERO CHRYSLER AVENGER, CALIBER JOURNEY, JEEP PATRIOT</p>
<p>64822</p> <p>KIT DE BUJES PARA PUENTE O BASTIDOR 2 CHICOS Y 2 GRANDES, NISSAN SENTRA</p>	<p>64823</p> <p>KIT DE BUJES PARA PUENTE O BASTIDO 2 CHICOS Y 2 GRANDES NISSAN X-TRAIL, ROGUE</p>	<p>88107</p> <p>BALERO PARA SOPORTE (224)</p>	<p>88508</p> <p>BALERO PARA SOPORTE (209)</p>	<p>88509</p> <p>BALERO PARA SOPORTE (220-226)</p>
<p>94501</p> <p>GOMA PARA BARRA ESTABILIZADORA EN NISSAN URVAN</p>	<p>4695626</p> <p>TORNILLOS ESTABILIZADOR CHRYSLER CIRRUS, STRATUS</p>			

INTERCAMBIOS / OEM INTERCHANGE
**SOportes PARA MOTOR Y TRANSMISIÓN
ENGINE & TRANSMISSION MOUNTS**

	OEM
1100	5IT6068B
1127	1794807
1128	1794808
1148	638841
1149	630629
1150	
1164	
1166	3688111
1169	757700
1196	
1197	
1417	3705444
1418	3789949
1731	B5S6038 A
1432	TAA 6068 A
1434	TFAA 6068 A
1443	D3TZ 6A061B
1466	3714358
1467	3714357
1577	3781954
1630	3743771
1631	3723646
1643	2298949
1646	2265018
1648	2265836
1649	2264675
1652	C4TZ 6068 A
1653	C5OM 6038 A
1654	D3 AZ 6038 E
1655	
1656	2463969
1657	2264140
1658	2264674
1659	2658784
1660	2298949
1664	2806842
1672	2806476
1674	
1675	3894198
1678	550053
1680	12526-06
1681	
1685	CITT 6068 A3173681
1694	290862C91
1701	
1703	96049392
1704	
1706	C9AA 6068 C
1707	C9AA 6068 N
1708	459020
1709	2533145
1710	2020856
1711	Z7TA 6038 A

	OEM
1713	D7AZ 6038 A
1714	113001263
1715	112202-1003
1717	11320-21210
1719	C8ZA 6068 B
1723	D0DA 6038 F
1725	7IDY 6038 AA
1727	830026400
1732	93410392
1734	
1735	3986683
1736	11222814801
1744	C3AZ 6038 A
1748	C3AZ 6038 B
1749	C2DZ 6038 B
1751	C2DZ 6038 C
1752	22145794
1757	D3ZA 6068 A4A
1758	D3AA 6068 A1A
1760	3632998
1761	3642831
1763	3442821
1764	3642818
1767	7701348676
1768	93429028
1769	6262215
1771	2013379
1770	D4ZD 6038 AB
1772	
1773	C8ZA 6068 F
1775	3817239
1776	H030656
1777	2017234
1778	2018184
1779	2779800
1781	357714
1782	93420642
1783	2018184
1784	
1785	11220-U9600
1786	11320-D97G0
1790	7700533493
1791	3526
1792	3526
1793	2526A06
1794	11220-897G0
1795	2526A06
1796	4088033
1797	E1TZ 6038 D
1798	EQUZ 6068 A
1799	4116442
1800	1132013WG0
1802	11320W57G0

	OEM
1803	11220-B97G0
1804	2025549
1805	311301265B
1808	4052566
1809	4191282
1810	4295198
1812	2779800
1813	93409392
1814	14073097
1815	U0112331C
1816	357412331A
1817	1132001A03
1818	1132011A01
1820	4052684
1821	22548148
1823	E53Z 6068 D
1824	11220-P04G0
1826	E53Z 6F010A
1830	1135011A02
1831	1136001A04
1832	171399151B
1833	171199214D
1834	11220W57G0211199
1835	22145832
1837	22146425
1838	10046806
1839	
1840	
1841	11220W1001
1842	22320C07G0
1843	54220C07G0
1844	54221C07G0
1845	D9ZZ 6068 A
1846	D8BZ 6068 B
1847	E1BZM 6038 B
1848	E1BZ 6038 A
1849	85TY 6C010 A
1850	86TY 6C010A
1852	
1855	F23Z 18183 A
1856	1370910
1860	181412329
1861	
1862	E3ZZ 6038 L
1863	E3ZZ 6038 K
1864	22112737
1865	E2TZ 6038 A
1866	E2TZ 6038 B
1867	171199214G
1868	
1870	E93Z 6068 A
1870-9	E93Z 6068 A
1871	E73Z 6068 B





INTERCAMBIOS / OEM INTERCHANGE
SOPORTES PARA MOTOR Y TRANSMISIÓN
ENGINE & TRANSMISSION MOUNTS

	OEM
1872	873Y 6C060A
1873	F23Z 6068 A
1873-9	F23Z 6068 A
1874	E53Z 6068 D
1879	C7TZ 6068 J
1880	C7TZ 6038 H
1881-H	E95Z 6068 C
1882	
1884	F33Z 6068 A
1884-H	F33Z 6068 A
1886	
1890	171412329A
1891	52019716
1892	52018289
1894	52019286
1895	52018289
1896	F4TZ 6068 B
1897	E8TZ 6083 G
1898	52019283
1899	4106422
1900	377199381E
1901	11360-02Y00
1902	11350-50A06
1903	113301263C
1904	113301264
1905	93230328
1906	90445298
1907	1664728C1
1908	1121067A00
1909	22538499
1910	4419642
1911	14049077
1912	52018234
1912-9	
1913	52018235
1913-9	
1914	
1915	
1917	52058217
1918	52058218
1919	52058219
1920	93420962
1922	2526-A-06
1924	111301265
1929	C3AZ 6038 G
1927	
1928	
1929	90495169
1932	17983129
1934	90495170
1935	93230328
1940	
1941	11211-50A06

	OEM
1942	BAC399201
1942-9	
1943	11321520A06
1944	
1949	F81A6D091AA
1970	17998971
1971	22658729
1972	2253878
1973	
1997	90468554
6622	D9AZ6068A
6661	1H0199609J
6662	1H0199262L
6663	191199402C
6675	F6DZ 6068C
6675-H	
6676	11320-W57G0
6677	321299151B
6679	
6682	
6683	
6684	11350-50Y00
6685	11220-0M010
6686	11210-75Y01
6687	
6688	
6689	
6691	
6692	191199279E
6693	357199402B
6694	11320-4B002
6695	4663228
6698	4593410
6700	4668314
6701	F4AZ6068A
6702	74AZ6068B
6703	F5RZ 5038 B
6705	F5RZ 5068 D
6705-9	F5RZ 5038 D
6706	F5RZ 6068 A
6707	F5RZ 6068 B
6710	17981101
6711	17996195
6712	E73Z 6068 D
6712-9	E73Z 6068 D
6714	F5RZ 6068 E
6714-9	F5RZ 6068 E
6715	E63Z 18192 B
6716	5432101A01
6717	5432050Y12
6718	5532050Y12
6720	17998895
6726	22105556

	OEM
6727	14080730
6728	1708729
6729	F0ZZ 18A161 B
6730	F1DZ 18183 B
6731	22146515
6732	22111681
6733	F1DZ 18192 A
6734	E1FZ 18198 C
6735	22074850
6736	5272550004
6737	F1CZ 18197 A
6738	33521137972
6739	181512333
6740	F0CZ 18183 A
6741	E7LY 18A161 A
6742	E7SY 18A161 A
6743	54320650
6744	4601937
6745	4582758
6746	31331139452
6747	31331135587
6748	4626100
6749	4626182
6750	4616703
6751	22156934
6752	22129482
6753	F5RZ 3A197 A
6754	F5RZ 18198 A
6755	52725SRO003
6758	4052850
6759	357412331 A
6760	90445207
6761	22146933
6762	90170695
6763	
6764	F4TZ 6038 A
6766	14049477
6768	52020018
6769	E8TZ 6038 E
6770	1258457
6771	363405
6773	J3219194
6774	10001752
6775	50840SV4980
6777	14069253
6778	14077778
6779	17985050
6781	10137308
6782	E9FZ 6068 A
6784	F23Z 18183 A
6785	
6786	E0SZ 6038 B
6787	





INTERCAMBIOS / OEM INTERCHANGE
SOportes PARA MOTOR Y TRANSMISIÓN
ENGINE & TRANSMISSION MOUNTS

	OEM
6788	E0SZ 6038 C
6789	C5TZ 3038 H
6790	12662668
6791	1255276
6792	17989705
6795	44026690
6796	E0ZS 6038 B
6797	E0SZ 6038 C
6799	
6800	
6801	11210-0M800
6802	112100M800
6803	11220-01A01
6804	11220-50Y10
6805	11320-50A02
6806	11320-50Y10
6807	1132050Y10
6808	50805S04000
6809	50806SV4981
6810	50810SR3983
6815, 6815-H	50810SV4J8Z
6816	50805S87A80
6817	50824501003
6818	508415R3030
6819	508425R3030
6821	11321-50A06
6822	11211-50A06
6823	
6824	11321-50A06
6828	
6829	
6831	52002334
3832	J3242711
6833	52002334
6834	F1CZ6068B
6834-9	
6835	F1CZ6038A
6835-9	
6837	22171575
6838-H	10448576
6839-H	3F2Z6068-BA
6840	4663228
6841	
6842	
6843	22171740
6844	22146688
6845	F4CZ6038B
6846-H	F1DZ 6068 B
6847-H	F4DZ 6038 A
6848-H	4663526
6849	4573775AB
6850	F0CZ6038A
6851	4578089AB

	OEM
6853	22174912
6854	
6856	F5RZ 5038 C
6857	F5RZ 5038 D
6858	
6859	
6860	
6861	
6862	Mb309260
6866	D3DZ 6038 C
6868	D5UZ 6038 A
6869	D5UZ 6038 B
6870	D8TZ 6038 A
6871	D8TZ 6038 B
6872	
6873	2212387
6874	15683966
6875-H	10340740
6876	17990968
6877	E8DZ 6F063 A
6878	E6DZ 6F063 A
6880	E6TZ6038H
6881	52058502
6882	52058503
6883	52058504
6884	52058505
6885	C5AZ 6038 C
6886	C5AZ 6038 D
6887	
6888	467428
6889	14080731
6890	E5TZ6068G
6891	F1TZ6038B
6892	F1TZ6038C
6893-H	E5TZ 6038 V
6894	F7TZ 6038 F
6897	
6899	4593397AF
6900	4593338
6901	4593338AD
6902	4668347
6903	4668193
6904	
6905	90445300
6906	
6907	811399151B
6908	
6909	15598555
6910	E8DZ 6038 B
6911	F1TZ 6038 A
6912	
6913-H	4612090
6914	22173023

	OEM
6916	329741
6918-H	
6919	E4FZ 6038 C
6920	
6921	E8DZ 6068 B
6922	
6923	E5TZ 6068 H
6924	E5TZ6068G
6928	D5UZ-6038E
6931	1789260
6932	15592505
6933	F09Z-6038 C
6934	F09Z-6038 D
6935	53008339
6936	F1DZ-6038 D
6937	22145446
6938	4861295AB
6939	
6940	
6941	
6942	
6943	4668192
6944	4668527
6945	
6946	
6948	
6949	F1TZ 6038 D
6950	52058486
6951	
6952	5069852AA
6853	5073099AA
6954	5069855AA
6958	
6959	
6960	
6961	
6963	
6964	
6966	
6967	
6969	
6970	11210-0M600
6970-9	
6971	
6973	
6974	
6975	
6976-H	1JO199262
6977	1JO199555
6978	1JO199851N
6979	2590932
6980	22590926
6981	F7UZ6038CA



	OEM
6982	F7UZ6038CB
6983	
6984	
6985	
6986	88964336
6988-H	7D0199132D
6989	X56169082CA
6990	96FBM121AJ
6990-9	
6991-H	96FB6038BK
6992	LE1S7W-3K155-AB
6993	LE1S71-18198-AG
6994	11320-40N00
6995	11220-36N00
6996	11233-VW101
6997	11321-VW000
6998	
6999	2555-6B049-AA
7000	YS4AZ6038FA
7001	MXS516B032AC
7002	97KB6038AD
7003	15149543
7004	15967994
7005-H	1121000QAA
7006	1132000QAE
7006-9	
7007	1132000QAA
7008	1122000QAB
7009	1122000QAA
7010	113204Z005
7011	9191494
7011-9	
7012	5281314
7013	MX5616038D
7014	90575456
7015	4694870
7016	2191025450
7017	7700829529
7018	4593337AB
7019-9	
7020	90538582
7021	9156951HC
7022	90538576
7023	90575772
7023-9	
7024	218134B310
7025	4663970
7026	54320AZ020
7027	3456050500
7028	04861269AD
7028-9	
7029	F1CZ18197A
7030	21910-25400

	OEM
7031-9	
7032	11220-9Y106
7034	8200399539
7035	4D0412377F
7036-H	7700437391
7037	7700427286
7038	11210A4010
7039	11210VW002
7040	112104M412
7041-H	184472
7041-9	1844-AIYA2
7042	184451
7043	50840S54990
7044	50805S5A033
7045	5043132900
7046	50840S5A010
7047	50810S5A013
7048	50820S5AA08
7049	150756
7050	50820-S3M-A81
7052	50805-SHJ-A01
7053	50806S87A80
7054	4861269AB
7055	5X0412331
7056	701399201AE
7057-H	6Q0199167J
7058	6Q019985IAD
7059	7D0 399 207B
7060	6Q019955AD
7061	701399201AD
7062	701199201C
7063-H	YS4Z6038BA
7064	YS4Z6068AA
7065	11220-1E810
7066	11210-1E813
7067	112704M400
7068	4593383AB
7069	112204Z000
7069-9	
7070	YS4Z-3A197-AA
7071-H	YS41-6038BA
7072-H	1M516F02BA
7073-H	YS4AZ-6038-FA
7074	93302286
7075	93302287
7076-H	93302282
7077	93302279
7078	90575186
7081	MXS616038AC
7082	M2S657M121AA
7083	M2S616P082AB
7086	93302281
7087	2193025400

	OEM
7088	94434208
7089	2183025400
7090	2183025450
7091	7D0199132E
7092-H	7D0199131D
7093-H	50810SXA00
7094	218114B021
7095	
7096	15149543
7097	15967994
7098-H	7D0399107
7099	97216754/55
7100	50805-S9A-983
7100-9	
7101	50840-S7C-980
7102	50810-S7D-003
7104	11210-CN000
7104-9	
7105	YI346 B032 HA
7106	F81A6038AF
7107	F81A6B032AE
7108	YL346 038FA
7109	YL346B 032FA
7110	YI346 038EA
7111	X74 6B032FA
7112	YI346 038GA
7113	
7114	
7115	F81A6038AF
7116	F81A6B032AE
7117	4L806068EA
7118	LY876038AA
7119	04861295AB
7119-9	
7120	
7121-H	4861272AE
7122	4861273AA
7123	10274661
7124	
7125	
7126	11270811310
7127	2184005200
7128	15732463
7129	112108H305
7130	112208H310
7131	1236175010
7132	1237162100
7133	
7134	123710H090
7135	123720H140
7136	50840-SAA-003
7137	50805-SLN-A01
7138	50810-SLN-003





INTERCAMBIOS / OEM INTERCHANGE
SOportes PARA MOTOR Y TRANSMISIÓN
ENGINE & TRANSMISSION MOUNTS

	OEM
7139	7H01998486
7140-H	50820-SLN-003
7141	11271-8J010
7141-9	
7142-H	12305-0D023
7143	7H0-399-151G
7144	
7145	7H0-199-849AT
7146	96340027
7148	96322965
7149	96484912
7150-H	96550234
7151-H	3M51-6F012-AF
7152	60685545-AA
7153	3M516P09AC
7154	3M516P093AE
7155	4M51GP093-F
7157-H	96550235/36
7158	96436399
7159-H	184477 / 182723
7160-9	
7161	184436
7164	180916
7165	50806-S0K-A80
7166	10274661
7167	
7168	
7169	
7170	
7171	
7172	10247084
7173	
7174	52019394AD
7175	52020243AB
7176	7A2Z6038D
7177	7A2Z6038CA
7178	
7180	
7180-9	
7181	
7183	
7184	
7185	1152321
7186	1571-6P082-CE
7187	5274951AA
7188	
7189	
7190	
7191	
7192	
7193	50850-SEA-A00
7194	
7195	

	OEM
7196	11360-ED000(EL00A)
7197	11220-ED000(ELS0A)
7198-H	F8RZ-6038-AA
7199-H	
7200	
7201	1237221150
7202	50860-SDA-A02
7203	
7204	1236321060
7205-H	50820-SEA-E01
7206-H	50830-SHJ-A04
7207-H	50810-S0K-A81
7208	5105494AD
7209	
7210	M2N156F012LA
7211	1Q0199555Q
7212	1Q0199555L
7213	9012412513
7215	M6S6P6F012-AB
7218-H	11360-ET00A
7219	11210-ET01D
7220	
7223	50890-SWA-A81
7224	50850-SNA-A01
7225	
7226	
7227	
7228	52019276AD
7233	25973870
7234	25973863
7235-H	3F2Z6038AA
7236-H	3F2Z6068AA
7237-H	
7238	
7239-H	22188128
7240	
7241	52058485
7243	
7244-H	
7245	2183005200
7246	2182122000
7247	11210-8J100
7248	510589AE
7249	9E5Z6068B
7250-H	
7253	52020244AA
7254	1K0199855AJ
7255-H	6E5Z6038DF
7256-H	123610H100
7257-H	123620P050
7258	96535499
7258-9	
7259	96535570

	OEM
7259-9	
7260	5491040
7260-9	
7261	
7262	96061642
7263	
7264	12363-04030
7265	
7266-EL	11270-8J10A
7267	11320-CA110
7267-EL	11320-5Z000
7268	50880-SNA-A82
7269	30027674
7272	52058936AC
7273	9159 (6837)
7274	11320-7S000
7275	11220-7S000
7276-H	6E5Z6038DF
7277-H	
7278-H	22697409
7279	05085078AB
7279-9	
7280	
7281	
7282	9L8Z6068A
7283	
7303	
7305	24443127
7306	
7307	1237128021
7308	
7309	12380-30010
7310	05085079AB
7311	
7313	13248630
7314	
7315	
7316	
7321	05171078AC
7322	11220-ET00A
7323-H	50820-SNA-A05
7324	11320-ZZ50B
7326	12361-75080
7329-H	05085082AB
7330	05171086-AC
7331	11350-BV000
7334-H	9156944
7335-H	9156925
7336-H	
7337	05085071-AB
7337-9	
7339-H	6L8Z6P094CA
7340	5L8Z6038AA





INTERCAMBIOS / OEM INTERCHANGE
SOportes PARA MOTOR Y TRANSMISIÓN
ENGINE & TRANSMISSION MOUNTS

	OEM
7343	219101G000
7345-H	
7346	219301G110
7347-H	
7348	0510589AE
7349	50810-TA0-A01
7354	
7358	
7359	510589AE
7360	
7361	5274952AA
7362	
7363	1236121020
7364	50800-S0K-A82
7365	94668812
7379-H	
7380	
7382-H	7L3Z-6038-CA
7383-H	7L3Z-6038-C
7387	13248551
7388	13248554
7389	50820-SHJ-A61
7390	
7391	
7392	15829209
7393	
7395	11220-8Y000
7396	50850-TA0-0A1
7397-H	50830-TA0-A01
7398-H	50870-TA0-A03
7398-H-9	50870TA0A03
7399-H	11210-EL01B
7400	22627518
7401	
7402-H	13248475
7403	13248610
7404	11320-8H501
7405	11360-JD00A
7406	11220-1HA0B
7407	11360-1HC0B
7409	11350-JY0A
7412	50880-SNA-A02
7413	50890-SNA-A02
7414	MN101387
7414-9	
7415-9	
7416	MR589152
7416-9	
7417-9	
7418-9	
7419	
7420	
7421	

	OEM
7422	
7423	
7424	
7425	
7425-9	
7426	04880383AA
7428-9	
7429	
7430-9	
7431-H	
7432	
7433	
7434	
7435	
7436	
7437	
7438	
7439	
7440-9	
7441	11220-1KG0A
7442-H	
7444	
7445	
7446	
7447	
7448-H	
7449	7H0-499-035-D
7450	7000-800-522
7451	13248607
7452-H	8E0-199-379-AD
7453-H	5N0-199-262G
7454	168-240-1218
7455	163-240-0117
7456-H	
7457	
7458	
7459	
7460	5S4Z-6068-BC
7461-H	2S61-6F012 AC
7462	
7463	
7464	7700 422 529
7466	220 240 02 18
7467-H	7H0 199 256F
7468-H	22 11 6 760 330
7469-H	
7470-H	
7471-H	
7472-H	
7473-H	
7474	1543330
7475	
7477	

	OEM
7478	
7479	
7480	
7481	2N15-6P082-CA
7482	SG-3094
7483-H	SG-3093
7484	SG-3104
7485	21810-0X100
7486-H	21810-1R000
7487-H	21810-2E000
7488	21830-1R000
7489	21830-2E100
7490	21910-2E501
7491-H	8V51-6F012AJ
7492	8V51-7M121AE
7493	11360-1KA1A
7494	
7495	8V51-6P082-AD
7496-H	95032353
7497-H	95190896
7498	
7499	
7500	
7501-H	
7502	
7503-H	
7504	
7508	
7509-H	
7510-H	
7511-H	
7512	
7513	
7514	
7515	
7516-H	
7517-H	
7518-EL	
7519-EL	
7520	
7522	
7523	
7524	
7525	
7526	
7527	
7528	
7529	
7530	123630V030
7532-H	
7533-H	
7534	
7535	





INTERCAMBIOS / OEM INTERCHANGE
SOPORTES PARA MOTOR Y TRANSMISIÓN
ENGINE & TRANSMISSION MOUNTS

	OEM
7536	
7537	
7538	
7540	
7541-H	
7542-H	
7543-H	
7544-EL	
7545	
7546	
7547	112207Z000
7548	
7549-9	
7550-9	
7551-9	
7552	
7553	
7554-H	
7555	
7556	
7557	
7558	
7559-H	
7560-H	
7561-H	
7562-H	
7563-H	
7564-H	
7565-H	
7566-H	
7567-H	
7568	
7569	
7570	
7571	
7575	
7576	
7577	
7578	
7579-H	22-11-6-778-610
7580-H	
7581	
7582	
7583	
7583-9	
7584	55366-792-AG
7585-H	2288-7775
7586	50820S-HJA03
7587	3441-2584-0458
7588	123630-P11
7589	210 240 03 18
7590	50850-SDBA00
7599-9	BL3Z-6038-G

	OEM
7600	22116756405
7601-H	7L3Z-6038-DA
7602	13324725
7603	
7604	11350-JA00A
7605	112103XN1A
7606	112203XN1A
7607	112203XA0A
7608	112103XA0A
7609	4F0-399-151-AP
7610	
7611	8E0-399-151-AQ
7612	22-11-6-56-406
7613-H	22-11-6-761-090
7614-H	22-11-6-761-089
7615-H	22-11-6-770-793
7616-H	218101-E000
7617	CV6Z-6068-A
7618	11270-2B000
7619	12372-74520
7620	12372-28040
7621	251-240-18-18
7622	202 240 04 18
7623	163 240 02 18
7628	123720V070
7629	30680750
7630-H	211-240-30-17
7631	MR112003
7632	50880-SNA-A81
7633-H	5082159A
7638-H	23466349
7639	21830-1G000
7640	MR554746
7641	123720-T050
7642	
7643-H	11210-1HS0A
7644	11320-8J005
7645	11320-7Z010
7646	11220-9BA0A
7647	50806-SQA980
7648	50880-T0A-A81
7649	50890-T0AA81
7650	50850-T0AA81
7651-H	8H6Z6038A
7651-9	
7652	96484904
7653-H	50820SXSA01
7654-H	1K01992620M
7655	25791900
7656	11380E T000
7657-H	508520SNGJ02
7658	11360JA000
7659-H	112109AM0A

	OEM
7660	1236320120
7661	GK2A39070D
7662	96280258
7663-H	50820T0TH01
7664	123630A040
7665-H	50820T0TH01
7666	1237128210
7667	123710V030
7668	1237128130
7669-H	1230521490
7670	50806SHJA01
7671	112709N00B
7672	113209N00A
7673	50830SVBA01
7674	123710T030
7675	50830T0TH81
7676	50850SZAA02
7677	50850SDAA10
7678	50806SHJA02
7679-H	50830T2FA11
7680	50810T2FA11
7681	50850T2FA11
7682	50820SM4981
7683	50810SM4981
7684	50810SM4J03
7685	8943255972
7686	8-97039-189-2
7687	MN100289
7688	112107Z000
7689	AV6Z6068A
7690	1236165031
7691	20839833
7692	20840181
7693-H	11210E T80A
7694	1171071LC0
7695	123050T051
7696	1237102060
7697	15829208
7698-H	4578194AE
7699	11360JA100
7700-H	113758078R
7701	1236231040
7702	F87Z6068CA
7703	1236374130
7704-H	50810SDBA02
7705-H	1230521220
7706	123620V060
7707	50850TG0T03
7708	123720P010
7708-H	123720P010
7709-H	50810S87A81
7710	50822TK6901
7711	112203NT0A





INTERCAMBIOS / OEM INTERCHANGE
BASES PARA AMORTIGUADOR
STRUT MOUNT

	OEM
1808	4186831
	4318717
	5204587
	4052566
	5204595
	5204615

	OEM
1815	1J0-412-331-C
	1J0412-249
	1J0-513-353-B
	33521137972

1816	357412331A
------	------------

	OEM
1820	4052684
	5204595
	5204615
	357412329

	OEM
1821	10068695
	10068696
	10068697
	22548144
	22548145
	88946245
	22064671
	22064808
	22064664
	22064671
	22064808
	22064664

1822	96FB-18198-AG
------	---------------

1829	96FB-3K155-AG
------	---------------

	OEM
1852	357-412-329
	357-412-331
	191-412-329A
	811-412-331
	191-412-329

1855	F23Z18183A
------	------------

	OEM
1860	191412329

	OEM
1886	357-412-329
	357-412-331
	191-412-329A
	811-412-331
	191-412-329

	OEM
1890	133-412-365
	171-412-329
	175-412-329
	175-412-329A
	171412329A

1997	90468554
------	----------

6636	4084005
------	---------

6641	4052850
------	---------

	OEM
6650	4404976
	4404977
	4684005
	4684006
	4684643
	4322760
	4684678
	4322620

	OEM
6666	17981901
	17981902
	17982905
	17982906
	17987223
	17987224
	17987227
	17987228
	17989072
	19781598
	22145420
17981597	

6687	811.412.323
	811-412-365

	OEM
6687	880-412-323B
	17981101

6710	17985585
	17981101

	OEM
6711	17980538
	17980539
	17980764
	17981465
	17981436
	17981437
	17989307
	17996195
	9764964
	9769604
17996193	

6715	E63118192B
------	------------

	OEM
6716	54320-50A00
	54321-01A01
	54329-16A00
	54329-01401

	OEM
6717	54320-50Y11
	54320-50Y12
	54325-0B000
	54325-21000
	54329-16A00

6718	55320-50Y10
	55320-50Y11
	55320-50Y12

	OEM
6720	17983974
	17989129
	17997162
	17997163
	17998656
	1798855
	17998895

6726	17985660
	17985837





INTERCAMBIOS / OEM INTERCHANGE
BASES PARA AMORTIGUADOR
STRUT MOUNT

	OEM
6726	17990923
	22098979
	22104461
	22105556
	21130008
	22146561
	17983307
	22098979
	22173219
6727	14106736
	140880730
	14080730
6728	10136865
	14080729
6729	E4ZZ-18161-A
	E5DZ-18A161-A
	E7ZZ18A161-A
	E7ZZ-18A161-B
	F0ZZ-18A161-B
	F4ZZ-18183-AA
6730	E6DZ-18183-A
	E7DZ-18183-A
	F1DZ-18183-A
	F1DZ-18183-B
6731	22145711
	22145610
	22145712
	221445615
	22146429
	22145705
	22171600
	22145706
	22173153
	22173158
	22175276
	88946380
	22173152
	22146515

	OEM
6732	17999443
	22111680
	22111681
	22112491
6733	E6DZ-18192-A
	F1DZ-18192-A
	F3DZ-18192-A
6734	E1FZ-18198-C
	E4FZ-18198-B
6735	22065048
	22064188
	22064125
	22064117
	22064554
	22065047
	22074850
	22064189
	22064122
22064126	
6736	52631-672-014
	52631-692-014
	52631-SB0-014
	52631-SFO-004
	52725-SB2-003
	52725-SB2-006
	52725-SB2-013
	52725-SM-A02
	52725-5S0-004
	52621-SB2-003
	52621-SB2-000
	52621-SB2-004
	52688-SE0-003
RPV100010	
6737	B455-28-390C
	B455-28-390D
	B455-28-390E
	B595-28-390
	EA01-28-390

	OEM
6737	F0CZ-18197-A
	F1CZ-18197-A
	F7CZ-18197-AA
	F7CZ-18197AB
6738	33521-128-819
	33521-132-104
	33521-137-972
	33-50-4035-929
	B032A
	33-52-6-751
33-526-6762	
6739	191.512.335
	823.512.332
	1713512.333
	191.512.333
	823.512.333
	F0CZ-18183-A
6740	F1SZ-18183-A
	F0CZ-18183-A
6741	E3SZ-18A161-A
	E7LY-18A161-A
6742	E7SZ-18A161-A
6743	543206500
	55320-0E000
	54320-65E00
	54320-0E001
	54320-0E000
6744	4601937
6745	4582758
6746	31331-124-508
	31331-139-452
6747	31331135587
6748	4626100
	5272227





INTERCAMBIOS / OEM INTERCHANGE

**BASES PARA AMORTIGUADOR
STRUT MOUNT**

	OEM
6748	5272226
	46268485
6749	4626182
6750	4616703
6751	1799218
	22146934
6752	22129482
	22178213
	F5RZ-3A197
6753	F5RZ-18198-B
	F5RZ-18198-AA
6754	F5RZ-18198-A
	F5RZ-18198-AA
6755	51631-SBO-003
	51631-SBO-004
	51631-SHO-003
	51631-SLO-003
	51631-SSO-004
	52725-SJ4-000
	52725-SRO-003
	52631-S84-A01
	51631-SV7-004
	51631-SHO-003
	51631-SLO-003
	51685-SR0-004
	51621-SD4-004
	51621-S84-A01
	52621-SK-000
	52726-SK3-000
	EGP1757
	RNF100090
	52725SRO003
	6758
4052850	
357-412-249	
357-412-319B	
1J0-412-249	

	OEM
6759	357.412331A
6760	90445207
	22146933
6761	799217
	22146933
6762	90170695
	E63Z-181892-A
	E63Z-18192-B
	F23Z-1883-A
	E6FZ-18183-A
6784	E43Z-18183-A
6906	1J0-513-353-B
6954	5069639AA
	88964336
	22182046
	2220754
	22178739
	22178510
22177853	
6986	22146949
	22177853
	22178510
	22178739
6992	YS4Z-3A197-AA
	YSAZ-118198-CCA
	YS4Z-18198-AA
	YSAZ-18198-AA
	LE1S7W-3K155-A
LE1S71-18198-AG	
6993	LE1571-18198
	4694870
	4684418
7015	4684129
7017	7700829529
	54320-4Z200

	OEM
7017	54320-4Z020
	54325-6M000
	54325-4Z000
	54320-4Z000
7026	54320-4M800
	H266-34-38X
	GN82-34-380
	GJ23-34-380B
	F12Z-18A161-C
F02Z-18A61-B	
7029	E92Z-18A161-B
7035	4D0-412-377F
7051	04766116AB
7051-KIT	
7055	5X0412331
7070	YS4Z-3A197-AA
7103	5X04123297
7147	9656858J
7156	8M59-18A116-AAA
7182	3M51-3K155DB
7214	1K0412331B
7221-KIT	F3XY-18B028-A
7222-KIT	22175165
7229-KIT	
7230-KIT	
7231-KIT	
7232-KIT	
7284-KIT	
7285-KIT	





INTERCAMBIOS / OEM INTERCHANGE
BASES PARA AMORTIGUADOR
STRUT MOUNT

OEM		OEM		OEM	
7286-KIT		7344	54610-1G500	7408-KIT	54320-1HJ0A
7287-KIT		7350-KIT		7410-KIT	
7288-KIT		7351-KIT		7411-KIT	
7289-KIT		7352-KIT		7427-KIT	54611-07000
7290-KIT		7353		7443-KIT	
7291-KIT		7355-KIT		7465	204 320 12 73
7292-KIT		7356-KIT		7505-KIT	
7293-KIT		7357		7506-KIT	
7294-KIT		7366-KIT		7507-KIT	
7295-KIT		7367-KIT		7521-KIT	
7296-KIT		7368-KIT		7539-KIT	
7297-KIT		7369-KIT		7571	
7298-KIT		7370-KIT		7572-KIT	
7299-KIT		7371-KIT		7573-KIT	
7300-KIT		7372-KIT		7574-KIT	
7301		7373-KIT		7591-KIT	51920-SAA-015 51920-SCC-015
7317	13188763	7374-KIT		7592-KIT	48609-52100
7318-KIT		7375-KIT		7593-KIT	4895-413-AD
7319-KIT		7376-KIT		7594-KIT	4895-414-AD
7320-KIT		7377-KIT		7595-KIT	48609-52011
7325-KIT		7378-KIT		7596-KIT	5171122AC
7327-KIT		7381-KIT		7597	8E5Z-18183-A
7328-KIT	22145711	7384-KIT		7598-KIT	48609-42020 48609-0R010
7332	05085461-AB	7385	13505131	7624	163 240 02 18
7333	96549921	7385	13505131		
7341-KIT		7386	13252362		
7342	46760673	7394	54320-ET-00A		





INTERCAMBIOS / OEM INTERCHANGE
BASES PARA AMORTIGUADOR
STRUT MOUNT

DAI	OEM
7625	33-50-3-401-685
	33-50-3-413-925
	33-50-3-450-542
7626	31-30-6-778-833
7634-KIT	5611SEA001
	4171182Z00
7394-KIT	54320-AZ60B
7635-KIT	54320-2W100
7636-KIT	88964326
7637-KIT	55322-8J000



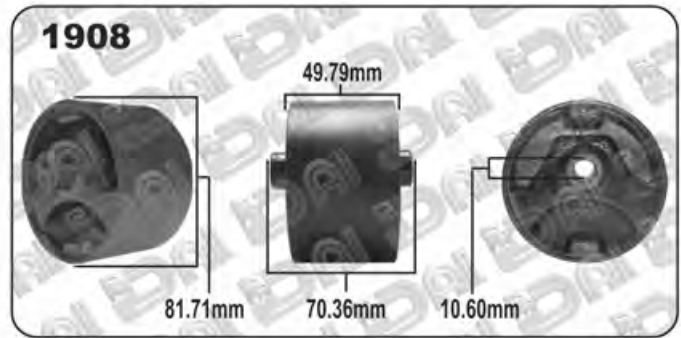
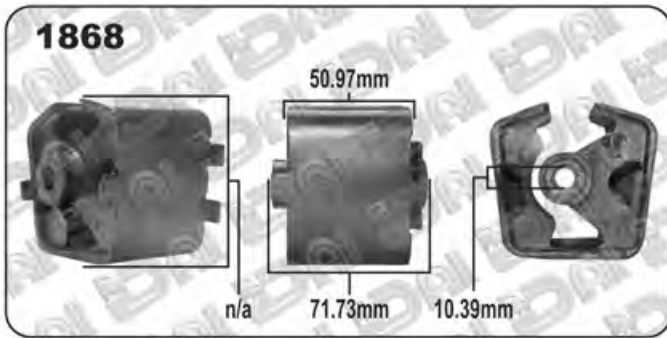



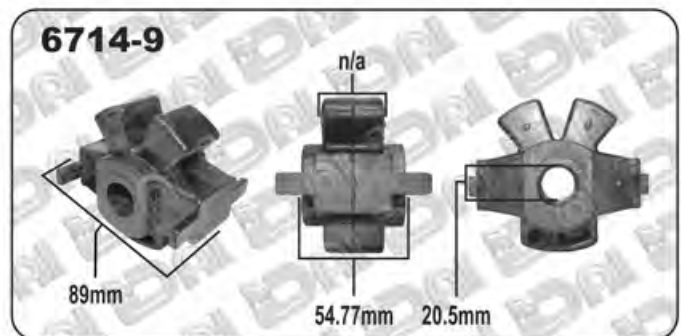
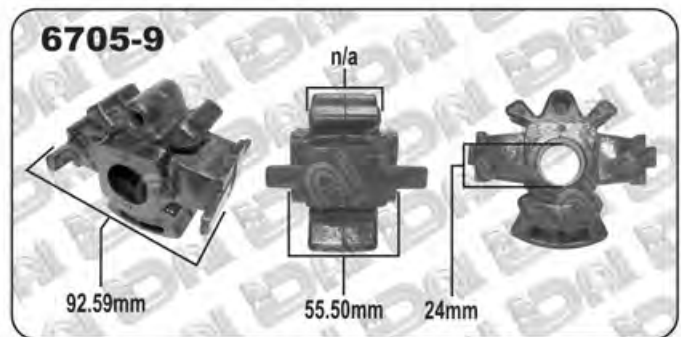

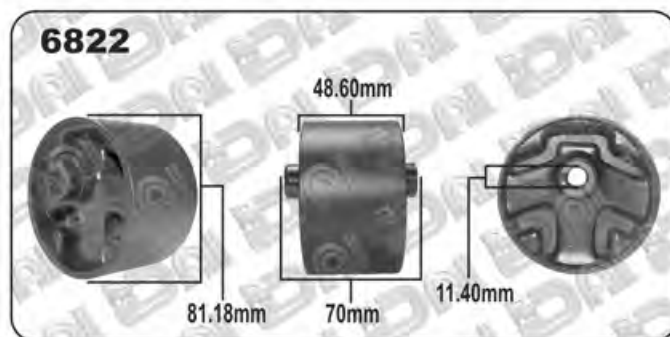
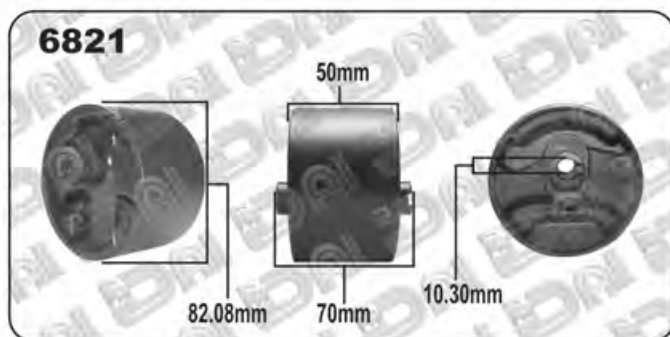
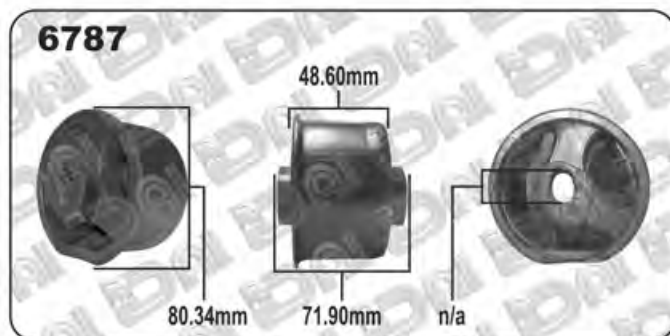
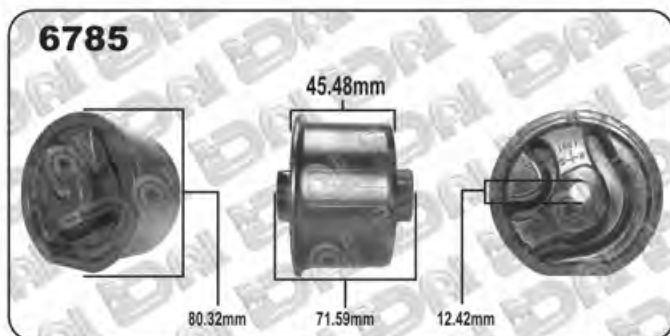
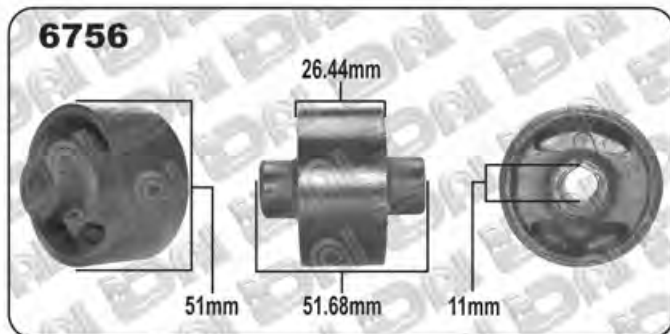

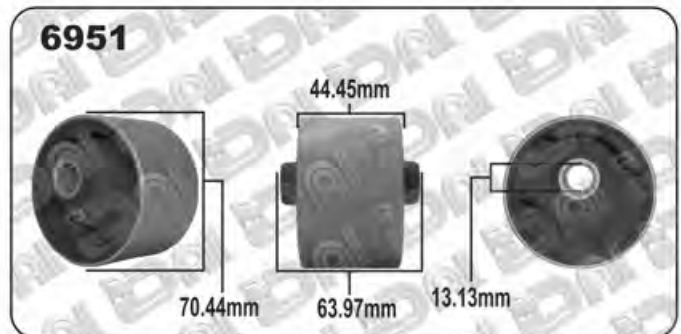
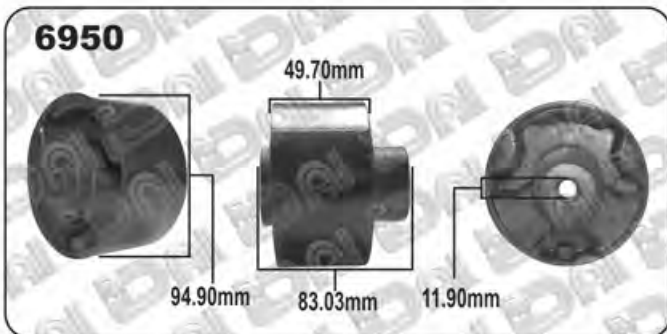
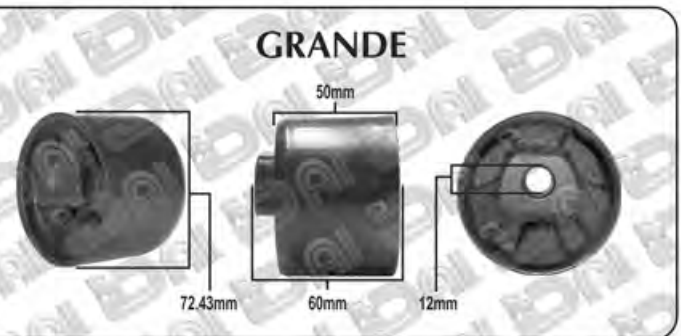

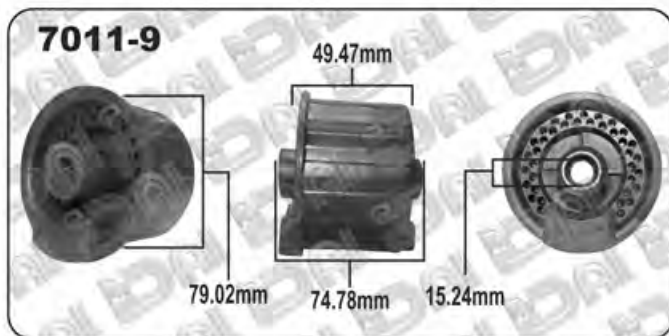
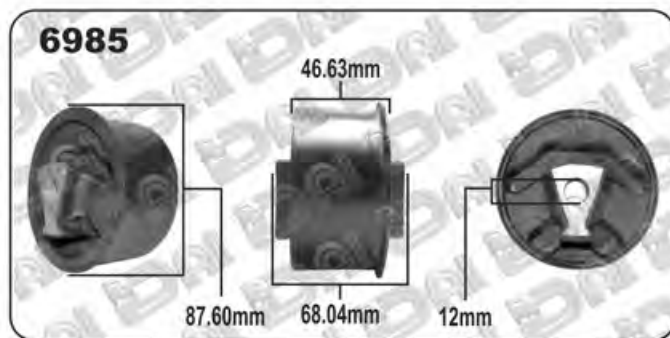
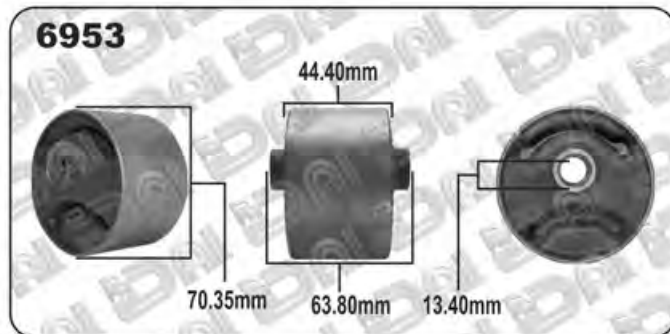
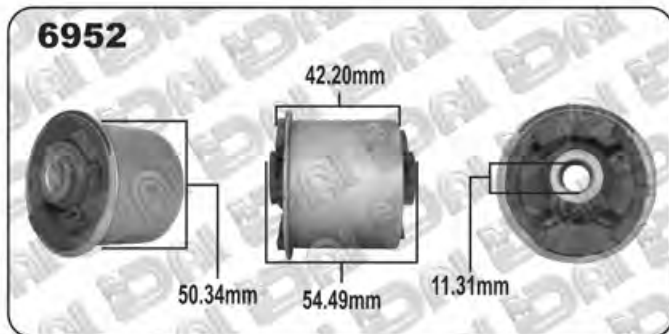

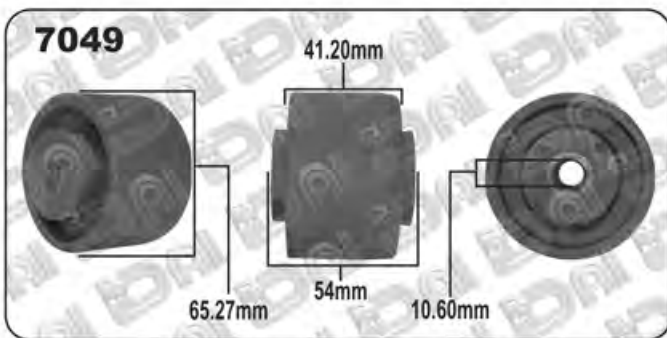
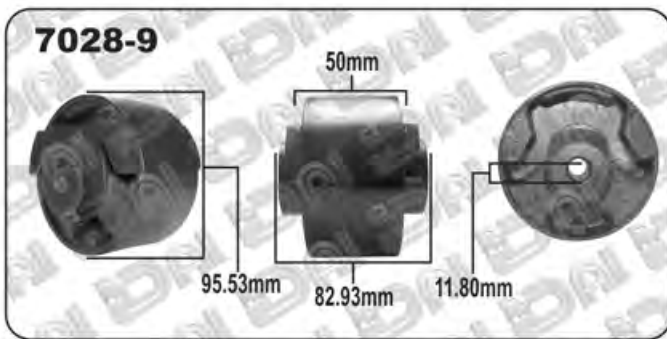

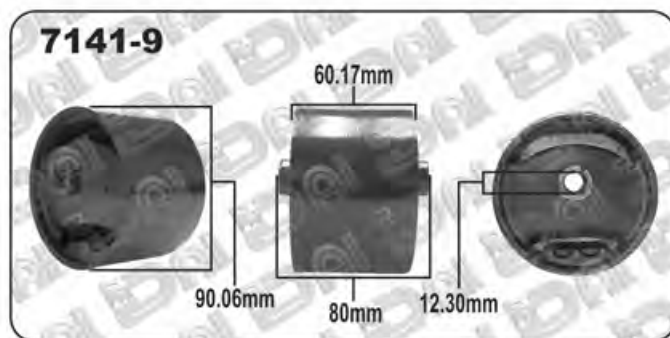
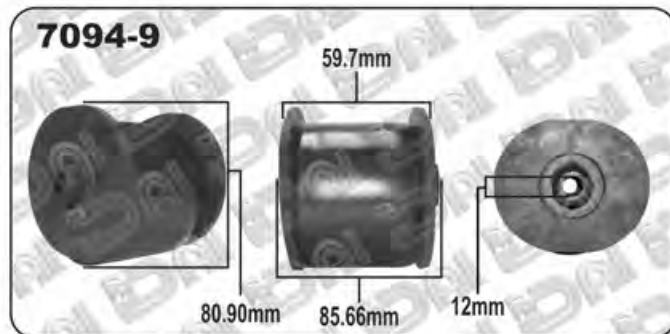

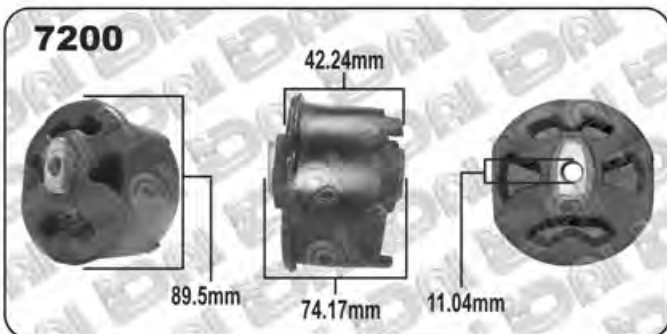
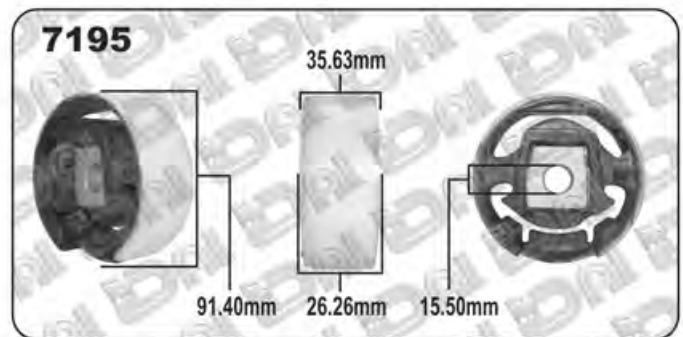
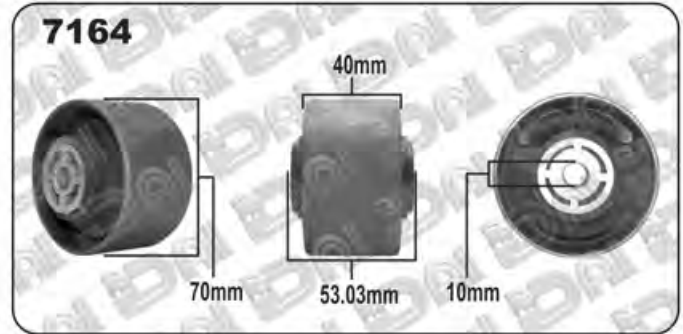
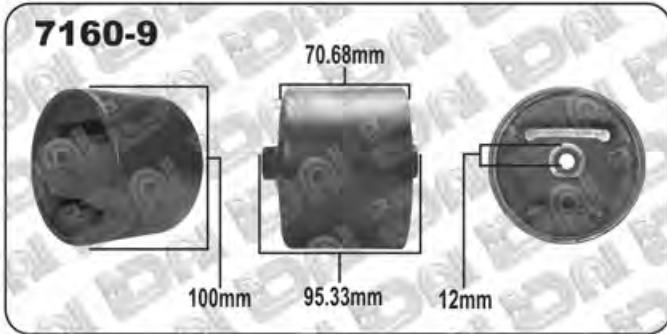

**MEDIDAS BUJES DE REPUESTO SOPORTES
PARA MOTOR Y TRANSMISIÓN**

7208-9



7209-9



7216-9



7217-9



7258-9



7259-9

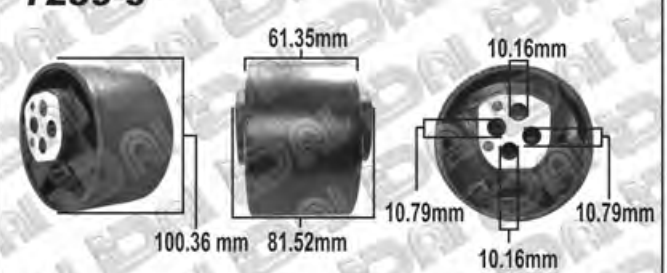

7279-9



7308-9



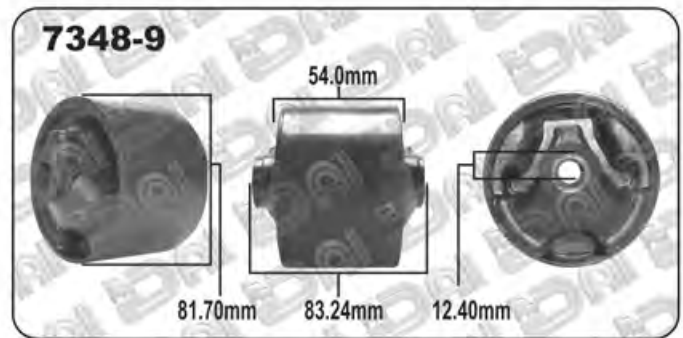

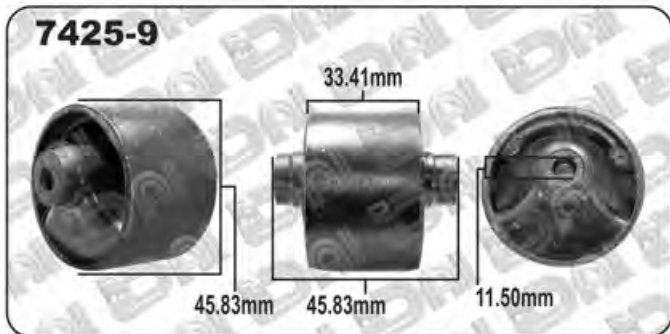



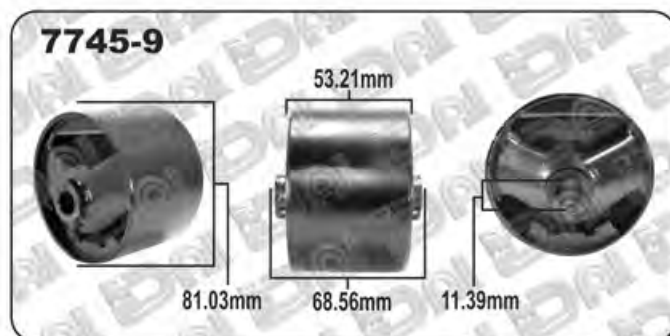
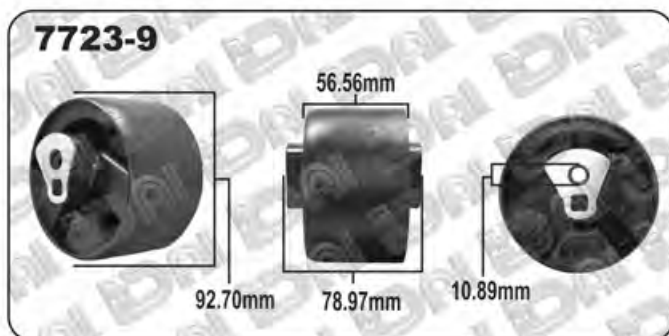
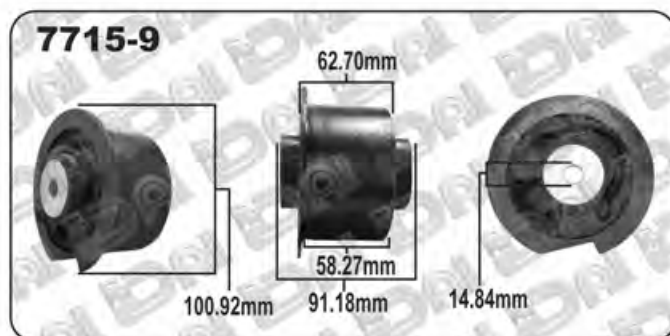
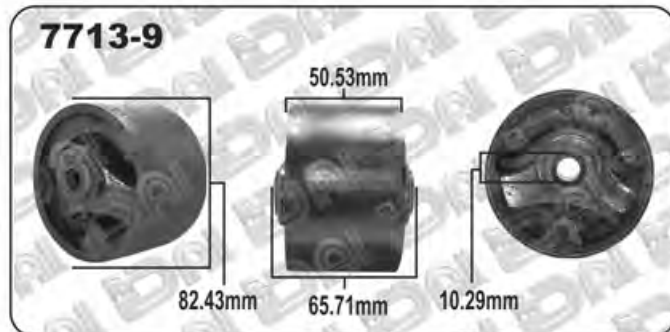
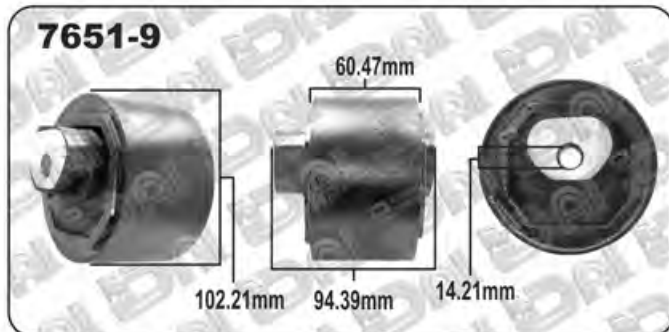

































**MEDIDAS BUJES DE RESPUESTO
SOPORTES PARA MOTOR Y TRANSMISIÓN**

































1070

IMPORTANTE: Identifica nuestro producto con el grabado del logo  No aceptes imitaciones.



<p>6300</p>  <p>24.00 130.00 42.00</p>	<p>6301</p>  <p>24.00 150.00 35.00</p>	<p>6302</p>  <p>18.00 88.00 94.00</p>	<p>6303</p>  <p>21.00 86.00 100.00</p>	<p>6304</p>  <p>22.00 82.00 85.00</p>
<p>6305</p>  <p>22.00 77.00 80.00</p>	<p>6306</p>  <p>21.00 78.00 84.00</p>	<p>6307</p>  <p>44.00 140.00 85.00</p>	<p>6308</p>  <p>23.00 95.00 80.00</p>	<p>6309</p>  <p>20.00 95.00 84.00</p>
<p>6310</p>  <p>22.00 121.00 84.00</p>	<p>6311</p>  <p>12.00 157.00 46.00</p>	<p>6312</p>  <p>21.00 112.00 66.00</p>	<p>6313</p>  <p>19.00 87.00 67.00</p>	<p>6314</p>  <p>20.00 98.00 82.00</p>
<p>6315</p>  <p>21.00 105.00 73.00</p>	<p>6316</p>  <p>24.00 100.00 81.00</p>	<p>6317</p>  <p>44.00 140.00 85.00</p>	<p>6318</p>  <p>26.00 120.00 90.00</p>	<p>6319</p>  <p>19.00 90.00 71.00</p>
<p>6320</p>  <p>30.00 102.00 80.00</p>	<p>6321</p>  <p>22.00 105.00 70.00</p>	<p>6322</p>  <p>20.00 118.00 62.00</p>	<p>6323</p>  <p>21.00 120.00 80.00</p>	<p>6324</p>  <p>18.00 105.00 78.00</p>
<p>6325</p>  <p>18.00 130.00 70.00</p>	<p>6326</p>  <p>20.00 118.00 62.00</p>	<p>6327</p>  <p>30.00 110.00 78.00</p>	<p>6328</p>  <p>21.00 103.00 76.00</p>	<p>6329</p>  <p>17.00 85.00 66.00</p>























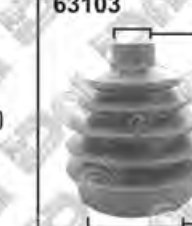



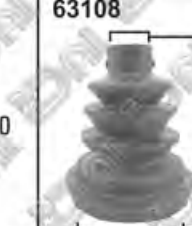



6330  18.00 130.00 65.00	6331  38.00 83.00 88.00	6332  32.00 96.00 70.00	6333  26.00 97.00 85.00	6334  25.00 105.00 85.00
6335  12.00 165.00 37.00	6336  10.00 205.00 33.00	6337  30.00 115.00 95.00	6338  24.00 125.00 86.00	6339  27.00 110.00 87.00
6340  30.00 112.00 90.00	6341  12.00 150.00 45.00	6342  10.00 160.00 55.00	6343  23.00 100.00 68mm	6344  24.00 190.00 46.00
6345  15.00 194.00 48.00	6346  18.00 86.00 67.00	6347  11.00 270.00 40.00	6348  10.00 177.00 40.00	6349  29.00 103.00 60.00
6350  23.00 90.00 76.00	6351  23.00 95.00 84.00	6352  25.00 168.00 52.00	6353  30.00 108.00 65.00	6354  11.00 160.00 35.00
6355  13.00 165.00 32.00	6356  33.00 123.00 83.00	6357  22.00 108.00 92.00	6358  22.00 105.00 85.00	6359  21.00 150.00 85.00



<p>6360</p> <p>22.00 92.00 87.00</p>	<p>6361</p> <p>12.00 210.00 52.00</p>	<p>6362</p> <p>12.00 170.00 42.00</p>	<p>6363</p> <p>12.00 175.00 47.00</p>	<p>6364</p> <p>14.00 215.00 48.00</p>
<p>6365</p> <p>11.00 200.00 30.00</p>	<p>6366</p> <p>12.00 172.00 45.00</p>	<p>6367</p> <p>16.00 195.00 46.00</p>	<p>6368</p> <p>15.00 180.00 47.00</p>	<p>6369</p> <p>11.00 185.00 44.00</p>
<p>6370</p> <p>11.00 190.00 30.00</p>	<p>6371</p> <p>11.00 165.00 44.00</p>	<p>6372</p> <p>12.00 200.00 50.00</p>	<p>6373</p> <p>10.00 185.00 40.00</p>	<p>6374</p> <p>10.00 185.00 40.00</p>
<p>6375</p> <p>20.00 105.00 70.00</p>	<p>6376</p> <p>11.00 210.00 42.00</p>	<p>6377</p> <p>10.00 210.00 45.00</p>	<p>6378</p> <p>23.00 100.00 86.00</p>	<p>6379</p> <p>12.00 145.00 38.00</p>
<p>6380</p> <p>20.00 108.00 80.00</p>	<p>6381</p> <p>13.00 180.00 43.00</p>	<p>6382</p> <p>26.00 115.00 100.00</p>	<p>6383</p> <p>35.00 98.00 101.00</p>	<p>6384</p> <p>25.00 95.00 84.00</p>
<p>6385</p> <p>22.00 130.00 78.00</p>	<p>6386</p> <p>20.00 110.00 72.00</p>	<p>6387</p> <p>25.00 115.00 95.00</p>	<p>6388</p> <p>22.00 120.00 77.00</p>	<p>6389</p> <p>16.00 110.00 62.00</p>

































6390  18.00 117.00 73.00	6391  24.00 103.00 85.00	6392  23.00 132.00 78.00	6393  21.00 88.00 75.00	6394  24.00 130.00 83.00
6395  21.00 105.00 100.00	6396  23.00 95.00 79.00	6397  22.00 110.00 80.00	6398  25.00 120.00 80.00	6399  12.00 200.00 58.00
63100  23.00 120.00 80.00	63101  20.00 105.00 68.00	63102  10.00 107.00 50.00	63103  28.00 95.00 93.00	63104  25.00 92.00 65.00
63105  15.00 180.00 55.00	63106  15.00 185.00 53.00	63107  22.00 125.00 75.00	63108  22.00 105.00 80.00	63109  15.00 200.00 48.00
63110  26.00 115.00 100.00	63111  25.00 95.00 84.00	63112  12.92 230.00 62.38	63113  23.00 95.00 90.00	63114  25.00 114.00 90.00
63115  22.00 93.00 55.00	63116  24.00 113.00 84.00	63117  26.00 81.55 53.00	63118  23.74 79.00 89.00	63119  21.00 87.60 74.00



<p>63120</p>	<p>63121</p>	<p>63123</p>	<p>63124</p>	<p>63125</p>
<p>63128</p>	<p>63129</p>	<p>63130</p>	<p>63132</p>	<p>63133</p>
<p>63134</p>	<p>63135</p>	<p>63136</p>	<p>63137</p>	<p>63138</p>
<p>63139</p>	<p>63140</p>	<p>63141</p>	<p>63142</p>	<p>63143</p>
<p>63144</p>	<p>63145</p>	<p>63146</p>	<p>63147</p>	<p>63148</p>
<p>63149</p>	<p>63150</p>	<p>63151</p>	<p>63152</p>	<p>63153</p>



63154  18.38 88.30 68.80	63155  18.38 88.30 68.80	63156  26.70 117.21 84.16	63157  22.19 88.93 78.12	63158  13.49 185.00 46.34
63159  30.31 101.78 92.05	63160  25.30 95.04 85.23	63161  23.23 92.35 75.70	63162  23.13 105.00 83.07	63163  14.07 163.00 47.99
63164  26.45 110.89 79.53	63165  26.50 104.65 81.79	63166  23.07 93.62 68.01	63167  24.67 92.85 87.75	63168  23.30 105.33 75.00
63169  26.18 105.63 82.33	63171  20.30 89.93 70.40	63173  27.98 102.36 73.50	63174  23.11 90.53 74.95	63175  25.16 110.59 81.02
63176  24.60 87.04 85.54	63177  13.53 156.00 50.30	63178  13.67 142.22 50.89	63179  28.75 113.84 97.22	63180  24.74 87.02 86.55
63181  27.40 110.24 89.35	63182  14.30 157.26 51.83	63183  24.33 87.82 78.65	63184  28.83 123.55 97.99	63185  23.60 87.79 83.22



<p>63186</p>	<p>63187</p>	<p>63188</p>	<p>63191</p>	<p>63192</p>
<p>63193</p>	<p>63194</p>	<p>63195</p>	<p>63196</p>	

CUBRE POLVOS CON TRIPOIDE / C.V. BOOTS TRIPOID

<p>6308</p>	<p>6310</p>	<p>6319</p>	<p>6328</p>	<p>6329</p>
<p>6343</p>	<p>6386</p>	<p>6387</p>	<p>6398</p>	<p>63113</p>
<p>63116</p>	<p>63119</p>	<p>63121</p>	<p>63123</p>	<p>63130</p>



CUBRE POLVOS CON TRIPOIDE / C.V. BOOTS TRIPOID

63135	63142	63145	63150	63153
63154	63157	63160	63161	63164
63166	63168	63169	63171	63174
63176	63180	63183	63185	



ACURA

7785



Soporte para Transmisión
Trasero Inferior STD.
TSX, 04-08, L4 2.4 lts.
OEM 50860SDAA12, 5860SDZA11

7809



Soporte para Transmisión
MDX 07-09, V6 3.7 lts.
TL 04-08, V6 3.2 lts.
07-08, V6 3.5 lts.
OEM 50850STXA03

DAI-0620-KIT



Tope y Cubre polvo para
Amortiguador tipo Universal
Frontal Izq. y Der.
MDX 01-02

AUDI

6977-9



Repuesto para Soporte
de Transmisión (6977)
A3 97-01, L4 2.0 lts.

6978-9



Repuesto para Soporte
de Motor Trasero (6978)
A3 97-01, L4 2.0 lts.

BMW

7810

MODELO	MOTOR	AÑO
325	L6 2.5	01-05
	L6 3.0	2006
325 CI	L6 2.5	01-06
	L6 3.0	
325 E	L6 2.5	01-05
	L6 3.0	2006
325 I	L6 2.5	01-06
	L6 3.0	
325 IS	L6 2.5	01-05
	L6 3.0	2006
325 IX	L6 2.5	01-06
325 IX	L6 3.0	
328 CI	V6 3.0	07-13

MODELO	MOTOR	AÑO
328 I	L4 2.0	07-08
	L6 3.0	10-13
	V6 3.0	07-13
328 IS	V6 3.0	07-13
328 XDRIVE	L6 3.0	10-13
328 XI	V6 3.0	07-13
330 CI	L6 2.5	01-06
330 I	L6 2.5	01-06
	L6 3.0	01-06 11-13
335 I XDRIVE	L6 3.0	11-13
335 IS		
525 I		06-08

MODELO	MOTOR	AÑO
525 XI	L6 3.0	06-07
528 E		2008
530 I		06-10
535 I		
X 1	L4 2.0	13-15
	L6 3.0	13-14
X 3	L6 3.0	03-10
	L4 2.5	03-06



Soporte para Transmisión
OEM
22316773125
22313422956
22316750858
22316773693



1079

IMPORTANTE: Identifica nuestro producto con el grabado del logo No aceptes imitaciones.



Continuación.. BMW

7827

MODELO	MOTOR	AÑO
128I 135I	L6 3.0	08-14
318I 318IS 318TI	L4 1.9	96-99
320I	L4 2.2	01-05
323CI 323I	L6 2.5	05-11
323IS	L6 2.5	05-11
	L6 2.8	96-00
325, 325E 325I, 325IS 325IX	L6 2.5	92-07
328CI, 328I 328IS, 328IC 328XI	L6 2.8	96-00

MODELO	MOTOR	AÑO
328CI, 328I 328IC, 328IS 328XI	V6 3.0	07-12
330CI 330I	L6 2.5	01-07
	L6 3.0	01-07
528E	L6 2.8	97-00
530I	V6 3.0	01-03
535D 535D XDRIVE	V6 3.0	15-16
	L6 3.0	01-03
535I	V6 3.0	15-16
	L6 3.0	01-03
535I GT 535I GT XDRIVE	V6 3.0	16-17
535I XDRIVE	V6 3.0	2016

MODELO	MOTOR	AÑO
640I 640I GRAN COUPE	V6 3.0	16-17
640I XDRIVE 640I XDRIVE GRAN COUPE		
M3	L6 3.2	96-00
	L6 4.0	11-12
Z3	L6 2.5	99-05
	L6 2.8	97-00
	L6 3.0	99-02
	L6 3.2	97-00
Z4	L4 2.5	03-05
	L6 3.0	03-12
	V6 3.0	2016



Soporte para Transmisión
STD. y AUT.
OEM 22316799331

BUICK

7802-H



Soporte para Transmisión
Trasero Inferior
Enclave 07-15, V6 3.6 lts.
OEM 84006114 Y 25840451

DAI-0621-KIT



Tope y Cubre Polvo
para Amortiguador Tipo Universal
Frontal Izq. y Der.
Lacrosse 10-13

DAI-0622-KIT



Tope y Cubre Polvo
para Amortiguador Tipo Universal
Frontal y Trasero Izq. y Der.
Rendezvous 02-07
Skyhawk 83-89

CADILLAC

DAI-0619-KIT



Tope y Cubre Polvo
para Amortiguador Tipo Universal
Frontal Izq. y Der.
Catera 97-01

DAI-0622-KIT



Tope y Cubre Polvo para Amortiguador Tipo Universal
Frontal Izq. y Der.
Cimarron 83-88, De Ville 91-93 y 00-05
Trasero Izq. y Der.
De Ville 91-93



1080

IMPORTANTE: Identifica nuestro producto con el grabado del logo No aceptes imitaciones.



CHEVROLET

<p>7802-H</p>  <p>Soporte para Transmisión Trasero Inferior Acadia 07-15, Traverse 07-16 V6 3.6 lts. OEM 84006114 y 25840451</p>	<p>7803-H</p>  <p>Soporte para Motor Derecho Cutlass 1999, V6 3.1 lts. Malibu 98-03, V6 3.1 lts. OEM 22657322</p>	<p>7823</p>  <p>Soporte para Motor Frontal Geo Prizm 93-97, L4 1.6 y 1.8 lts. OEM 1236164210, 1236111160 1236111170</p>	<p>7825</p>  <p>Soporte para Motor Trasero Malibu 09-12, L4 2.4 lts. 2008, L4 2.0, 2.4 lts. y V6 3.5 lts. OEM 22820087 y 25846771</p>	<p>DAI-0620-KIT</p>  <p>Tope y Cubre polvo para Amortiguador tipo Universal Frontal Izq. y Der., Cavalier 92-94 Monte Carlo 97-99, Lumina 95-96</p>
<p>DAI-0619-KIT</p>  <p>Tope y Cubre Polvo para Amortiguador Tipo Universal Frontal Izq. y Der. Cavalier 95-05, Chevy Nova 82-88, Chevy Joy, Chevy Pop, Chevy Swing Chevy Monza 93-12, HHR 05-11, Malibu 06-12, Malibu SS 06-07 Malibu 97-05</p>	<p>DAI-0621-KIT</p>  <p>Tope y Cubre Polvo para Amortiguador Tipo Universal Frontal Izq. y Der. Camaro 10-12</p>	<p>DAI-0622-KIT</p>  <p>Tope y Cubre Polvo para Amortiguador Tipo Universal Frontal Izq. y Der. Berreta 87-91, Cavalier 84-91, Celebrity 83-96, Citation 83-85, Corsica 87-91 Frontal y Trasero Izq. y Der. Impala 00-13, Lumina 89-96, Malibu 97-03, Monte Carlo 97-05 Venture 97-05, Uplander 05-09</p>		

CHRYSLER

<p>DAI-0619-KIT</p>  <p>Tope y Cubre Polvo para Amortiguador Tipo Universal Frontal Izq. y Der., 300 M 98-04, 600 82-83 400 y Aries 1983, Intrepid 93-04, Caravan 01-07, Concorde 93-04 LHS 94-01, New Yorker 94-97, PT Crusier 01-10, Town Country 01-07 Frontal Izq. y Der. Neon 95-05, Trasero Izq. y Der. Neon 00-05</p>	<p>DAI-0620-KIT</p>  <p>Tope y Cubre polvo para Amortiguador tipo Universal Frontal Izq. y Der. Caravan 86-00, Dynasty y New Yorker 88-93, Grand Voyager 84-00 Town & Country 90-00, Voyager 84-00</p>
<p>DAI-0621-KIT</p>  <p>Tope y Cubre Polvo para Amortiguador Tipo Universal Frontal Izq. y Der. Daytona 89-93, Lebaron 89-95 Trasero Izq. y Der. Neon 95-99, Shadow 89-94, Spirit 89-95</p>	<p>DAI-0622-KIT</p>  <p>Tope y Cubre Polvo para Amortiguador Tipo Universal Frontal y Trasero Izq. y Der. 600 84-86, Aries 84-89, Daytona 84-88 Laser 87-86, New Yorker 84-87</p>



FORD

<p>7151-H-9</p>  <p>Repuesto para Soporte de Motor Derecho (7151-H) Focus 05-17, L4 2.0 lts. 07-10, L5 2.5 lts. Transit Connect 10-13, L5 2.0 lts.</p>	<p>7811</p>  <p>Soporte para Transmisión Mustang 99-04, V6 3.8 y 4.6 lts. 2004, V6 3.9 y 4.4 lts. OEM 1R3Z6068ZZ y XR3Z6068AA</p>	<p>7817-H</p>  <p>Soporte para Motor Frontal Derecho Taurus 96-99, V6 3.4 lts. OEM F7DZ6038BA</p>	<p>7820-H</p>  <p>Soporte para Motor Derecho Fusion 13-17, L4 2.5 lts. OEM DG9Z6038H</p>	<p>7832</p>  <p>Soporte para Motor Trasero Torque Strut (Diesel) Transit 07-13, L4 2.2 lts. OEM 3C116P082AC</p>
<p>7824</p>  <p>Soporte para Motor Trasero (Torque Strut) Fusion 06-12, V6 3.0 lts., 06-09 L4 2.3 y V6 3.0 lts., 10-12 V6 3.5 lts. OEM 9E5Z6068D, 8E5Z6068D, 8H6Z6068A y 8E5Z6068D</p>	<p>7829-H</p>  <p>Soporte para Transmisión Edge 07-14, V6 3.5 lts. 11-14, V6 3.7 lts. OEM 7A1Z6038AA</p>	<p>DAI-0619-KIT</p>  <p>Tope y Cubre Polvo para Amortiguador Tipo Universal Frontal y Trasero Izq. y Der., Escort Zx2 98-03, Probe 89-92 Frontal Izq. y Der., Escort 83-03, Tempo 84-85 Trasero Izq. y Der., Escort 97-03</p>		
<p>7833</p>  <p>Soporte para Transmisión (Diesel) Transit 07-13, L4 2.2 lts. OEM 3C117M124AD</p>	<p>DAI-0620-KIT</p>  <p>Tope y Cubre polvo para Amortiguador tipo Universal Trasero Izq. y Der., Escort 83-90, Tempo 84-94 Frontal Izq. y Der., Fairmont 78-83, Focus 2005 Tempo 85-94, Thunderbird 87-88 Frontal y Trasero Izq. y Der., Guía 84-94</p>		<p>DAI-0621-KIT</p>  <p>Tope y Cubre Polvo para Amortiguador Tipo Universal Frontal Izq. y Der., Mustang 84-04, Mustang Cobra, Mustang GT 94-04 Thunderbird 80-97, Windstar 94-03, Cougar 83-97, Sable 94-06 Frontal y Trasero Izq. y Der., Taurus 86-94 Trasero Izq. y Der., Sable 94-95</p>	

HONDA

<p>7785</p>  <p>Soporte para Transmisión Trasero Inferior STD. Accord 03-07, L4 2.4 lts. OEM 50860SDAA12 y 50860SDZA11</p>	<p>7795-H</p>  <p>Soporte para Motor Derecho Inferior (4 Puertas) Honda Civic 06-11, L4 1.8 lts. OEM 50820-SNA-P01</p>	<p>7808</p>  <p>Soporte para Motor Trasero Inferior Accord 03-07, V6 3.0 lts. OEM 50860SDPA10 y 50860SDAA12</p>	<p>DAI-1409055</p>  <p>Bujes para Horquillas o Tirantes Trasero Civic 01-05</p>
--	--	---	--



HYUNDAI

DAI-0619-KIT



Tope y Cubre Polvo para
Amortiguador Tipo Universal
Frontal Izq. y Der.
Verna 03-05

INFINITI

DAI-0619-KIT



Tope y Cubre Polvo para
Amortiguador Tipo Universal
Frontal Izq. y Der.
G20 91-96

DAI-0622-KIT



Tope y Cubre Polvo
para Amortiguador Tipo Universal
Frontal y Trasero Izq. y Der.
130 y 135 96-99

LINCOLN

7824



Soporte para Motor
Trasero (Torque Strut)
MKZ 07-12, V6 3.5 lts.
Zephyr 2006, V6 3.0 lts.
OEM 9E5Z6068D, 8E5Z6068D
8H6Z6068A y 8E5Z6068D

7829-H



Soporte para Transmisión
MKX 07-10, V6 3.5 lts.
11-15, V6 3.7 lts.
OEM 7A1Z6038AA

DAI-0620-KIT



Tope y Cubre polvo para
Amortiguador tipo Universal
Frontal Izq. y Der.
Zephyr 78-83



1083

IMPORTANTE: Identifica nuestro producto con el grabado del logo  No aceptes imitaciones.



MAZDA

7151-H-9



Repuesto para Soporte de Motor Derecho (7151-H) 3 04-10, L4 2.0 y L4 2.3 lts. 5 06-11, L4 2.3 lts.

7822



Soporte para Transmisión 3 14-16, L4 2.0 y L4 2.5 lts. 6 14-17, CX-5 14-16, L4 2.5 lts. OEM BJS739070, BPH439070 y KD4539070

DAI-0619-KIT



Tope y Cubre Polvo para Amortiguador Tipo Universal Frontal Izq. y Der. 626 83-87

MERCURY

7817-H



Soporte para Motor Frontal Derecho Sable 96-99, V6 3.0 lts. OEM F7DZ6038BA

7824



Soporte para Motor Trasero (Torque Strut) Milan 06-12, V6 3.0 lts. 06-09 L4 2.3 lts. y V6 3.0 lts. OEM 9E5Z6068D, 8E5Z6068D 8H6Z6068A y 8E5Z6068D

DAI-0619-KIT



Tope y Cubre Polvo para Amortiguador Tipo Universal Trasero Izq. y Der. Sable 94-06 Frontal Izq. y Der. Villager 93-02

DAI-0620-KIT



Tope y Cubre polvo para Amortiguador tipo Universal Frontal Izq. y Der. Cougar 87-88, Topaz 85-94 Trasero Izq. y Der. Capri 91-93

MITSUBISHI

7806



Soporte para Transmisión Lateral Izquierdo 4x4 L-200 08-16, L4 2.4 y 2.5 lts. OEM MR267864

7821



Soporte para Motor Trasero Outlander 03-05, L4 2.4 lts. OEM MN100335



NISSAN

7801



Soporte para Motor Derecho
Almera y Sentra
00-06, L4 1.8 lts.
OEM 112104Z010

7835



Soporte para Motor Trasero Torque Strut
Juke 11-18, Sentra (SR Turbo) 17-18
L4 1.6 lts.
OEM 113601KC0A

64661



Goma o Buje Grande p/Horquilla Inf.
Lucino 96-00, Maxima 95-99,
Sentra 91-00
Tsubame 93-04, Tsuru III 92-97
OEM 54570-4B000

DAI-0619-KIT



Tope y Cubre Polvo para Amortiguador Tipo Universal
Frontal Izq. y Der., Altima 93-01, Lucino 95-99, Maxima 04-08
Quest 93-02, Sentra 96-99, Tsubame 96-97
Tsuru I 84-87, Tiida 07-17, Tsuru III 92-15
Frontal Izq. y Der. Tsuru II 88-91
Trasero Izq. y Der. Maxima 89-94

DAI-0620-KIT



Tope y Cubre Polvo para Amortiguador tipo Universal
Frontal Izq. y Der., 240SX 89-98, Datsun 69-74, Datsun 160J 79-84,
Datsun 710 69-74, Maxima 83-94 y 89-94
Trasero Izq. y Der., Altima 93-01, Samurai 79-84, Tsuru III 92-15

DAI-0621-KIT



Tope y Cubre Polvo para Amortiguador Tipo Universal
Trasero Izq. y Der.
Maxima 86-89, Stanza 87-89

DAI-0622-KIT



Tope y Cubre Polvo para Amortiguador Tipo Universal
Frontal y Trasero Izq. y Der.
Maxima 85-88 y 95-99, Stanza 87-89

OLDSMOBILE

7803-H



Soporte para Motor Derecho
Alero 99-01, L4 2.4 lts.
02-04, V6 3.4 lts.
OEM 22657322

DAI-0622-KIT



Tope y Cubre Polvo para Amortiguador Tipo Universal
Frontal Izq. y Der.
Calais 85-91, Cutlass 85-96, Cutlass Ciera 82-96
Eurosport 85-90, Silhouette 97-05

PLYMOUTH

DAI-0619-KIT



Tope y Cubre Polvo para Amortiguador Tipo Universal
Frontal Izq. y Der.
Reliant 1983

DAI-0621-KIT



Tope y Cubre Polvo para Amortiguador Tipo Universal
Frontal Izq. y Der.
Acclaim 89-95, Sundance 89-94

DAI-0622-KIT



Tope y Cubre Polvo para Amortiguador Tipo Universal
Frontal Izq. y Der., Caravelle, Reliant 84-88
Sundance 87-88



1035

IMPORTANTE: Identifica nuestro producto con el grabado del logo No aceptes imitaciones.



PONTIAC

7803-H



Soporte para Motor Derecho
Grand Am 99-01, L4 2.4 lts.
02-05 V6 3.4 lts.
OEM 22657322

7825



Soporte para Motor Trasero
Pontiac G6 2008, L4 2.4 y V6 3.5 lts.
OEM 22820087 y 25846771

DAI-0619-KIT



Tope y Cubre Polvo para Amortiguador Tipo Universal
Frontal Izq. y Der. Grand Am 99-05
Sunfire 95-05, G5 07-09, G6 05-10

DAI-0621-KIT



Tope y Cubre Polvo
para Amortiguador Tipo Universal
Frontal Izq. y Der.
Grand Am 92-98

DAI-0622-KIT



Tope y Cubre Polvo para Amortiguador Tipo Universal
Frontal y Trasero Izq. y Der., Bonneville 91-99
Frontal Izq. y Der., Grand Am 85-05, Grand Prix 97-08

RENAULT

DAI-0619-KIT



Tope y Cubre Polvo para
Amortiguador Tipo Universal
Frontal Izq. y Der.
Kangoo 03-12

SATURN

7802-H



Soporte para Transmisión
Trasero Inferior
Outlook 09-10
OEM 84006114 Y 25840451

7825



Soporte para Motor Trasero
Aura 2009, L4 2.4 lts.
2008 L4 2.4 lts. y V6 3.5 lts.
OEM 22820087 y 25846771



SEAT

6977-9



Repuesto para Soporte de Transmisión (6977)
Alhambra 01-10, L4 1.8 y V6 2.8 lts.
Leon y Toledo 00-06
L4 1.8 y L4 2.0 lts.

6978-9



Repuesto para Soporte de Motor Trasero (6978)
Alhambra 01-10, L4 1.8 y V6 2.8 lts.
Leon y Toledo 00-06
L4 1.8 y L4 2.0 lts.

TOYOTA

7807



Soporte para Motor Izq. y Der.
4Runner 03-09, FJ Cruiser 07-09
V6 4.0 lts.
OEM 12361-31081

7813



Soporte Para Motor Frontal
Camry 97-01, Solara 99-01, L4 2.2 lts.
OEM 1236103060

7823



Soporte para Motor Frontal
Corolla 93-97, L4 1.6 y 1.8 lts.
OEM 1236164210, 1236111160
1236111170

7830



Soporte para Transmisión STD. 4X4
Tacoma 05-15, L4 2.7 lts.
OEM 123710C150

DAI-0619-KIT



Tope y Cubre Polvo para Amortiguador Tipo Universal Frontal Izq. y Der.
Avalon 95-96, Camry 96-06
Frontal Izq. y Der., RAV4 96-00

DAI-0620-KIT



Tope y Cubre Polvo para Amortiguador tipo Universal Frontal Izq. y Der. Corolla 98-02

VOLKSWAGEN

6977-9



Repuesto para Soporte de Transmisión (6977)
Beetle 98-12, Golf A4 98-13
Jetta A4 98-14
L4 1.8 y L4 2.0 lts.

6978-9



Repuesto para Soporte de Motor Trasero (6978)
Beetle 98-12, Golf A4 98-13
Jetta A4 98-14
L4 1.8 y L4 2.0 lts.



1087

IMPORTANTE: Identifica nuestro producto con el grabado del logo  No aceptes imitaciones.





Es...

La Línea más completa en productos de Hule y Hule-Metal

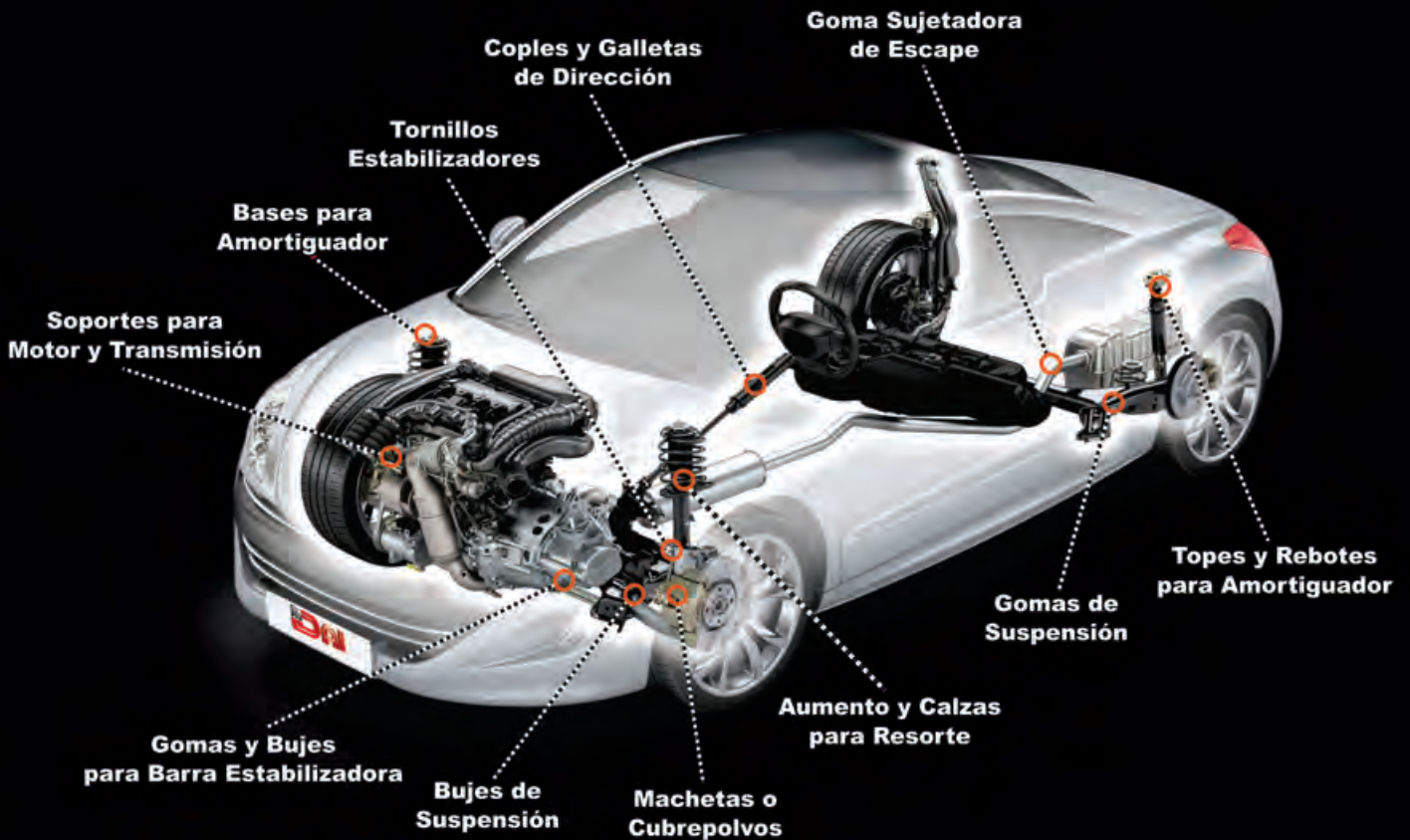

¡Tu Soporte en el Camino!

Amigo Mecánico y Refaccionario si tienes alguna sugerencia para hacer más valioso este catálogo comunícate con nosotros al 5649*1703 o al correo fortiz@dai.com.mx y recibe una SORPRESA DAI.



¡ Tu soporte en el camino !



www.dai.com.mx

Distribuidora de Auto Industrias, S.A. de C.V.
Recursos Petroleros No. 14, Parque Industrial La Loma
Tlalnepantla de Baz, Edo. de México, C.P. 54060
Tel. (55) 5649 1703